

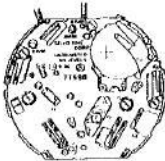

PARTS CATALOGUE / TECHNICAL GUIDE

Cal. 7T52B

Cal. 7T59B

[SPECIFICATIONS]





Item		Cal. No.	7T52B	7T59B
Movement				
			The illustrations refer to Cal. 7T59B. (x 1.0)	
Movement size	Outside diameter		ø27.6mm 24.0mm between 3 o'clock and 9 o'clock sides	
	Casing diameter		ø27.0mm 24.0mm between 3 o'clock and 9 o'clock sides	
	Height		3.2mm	4.0mm
Time indication			Main time Hour, minute and small second hands 24-hour hand (Cal. 7T59)	Stopwatch Hour hand (12-hour indication system) Minute hand (30-minute indication system) Second, 1/10-second, 1/100-second hands
Driving system			Step motor, 4 pieces	
Additional mechanism			<ul style="list-style-type: none"> • Electronic circuit reset switch • Train wheel setting device • Battery life indicator • Date calendar • Instant setting device for date calendar • Day calendar (Cal. 7T59) • Instant setting device for day calendar (Cal. 7T59) • Independent adjustment of hour hand (Cal. 7T59) • Stopwatch function with 1/100-second hand • Dual time function (Cal. 7T59) 	
Loss/gain			Monthly rate at normal temperature range: less than 15 seconds	
Regulation system			Nil	
Measuring gate by quartz tester			Use 10-second gate.	
Battery			SEIKO SR927W, Maxell SR927W, SONY SR927W, EVEREADY 399 Battery life is approximately 2 years. Voltage: 1.55V	
Jewels			0 jewel	

PARTS CATALOGUE

Cal. 7T59B

Disassembling procedures Figs. : ① → ⑨④

Reassembling procedures Figs. : ⑨④ → ①

Lubricating: Types of oil		Oil quantity
	Moebius A	 Normal quantity
	SEIKO Watch Oil S-6	 Extremely small
	Silicone oil 500,000 c.s.	

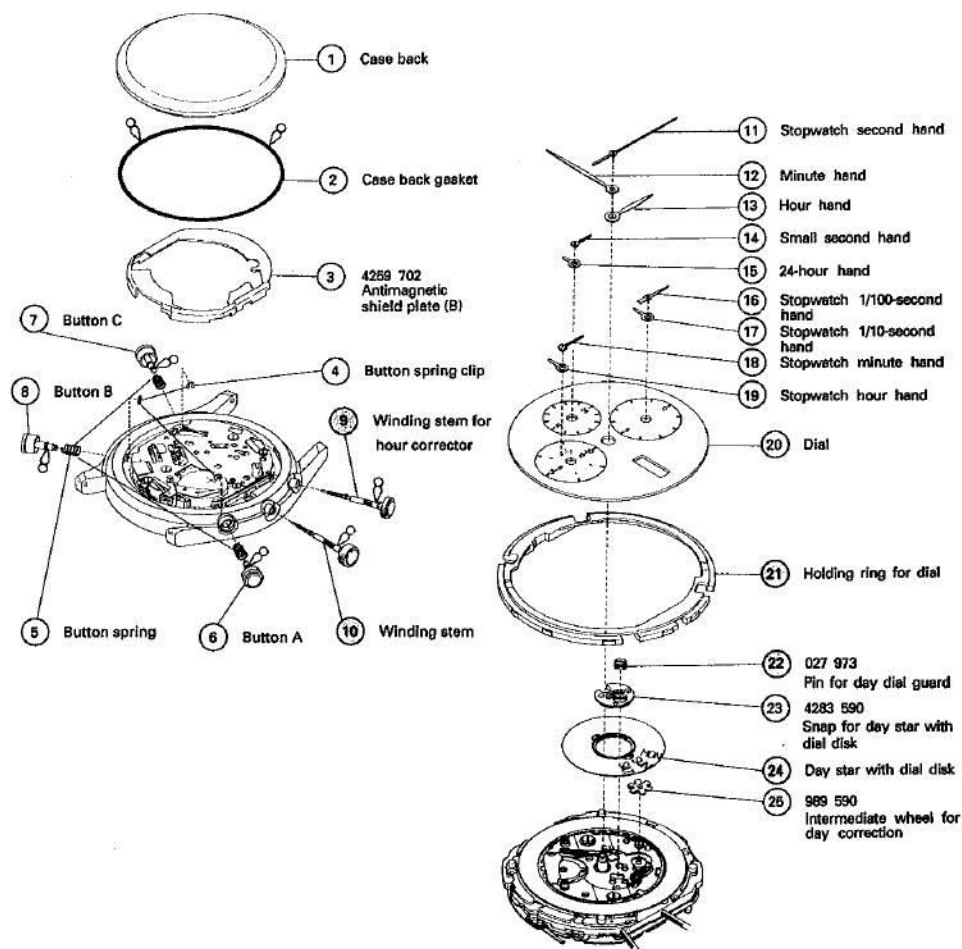

 Please see the remarks on the following pages.

PARTS CATALOGUE

Cal. 7T59B

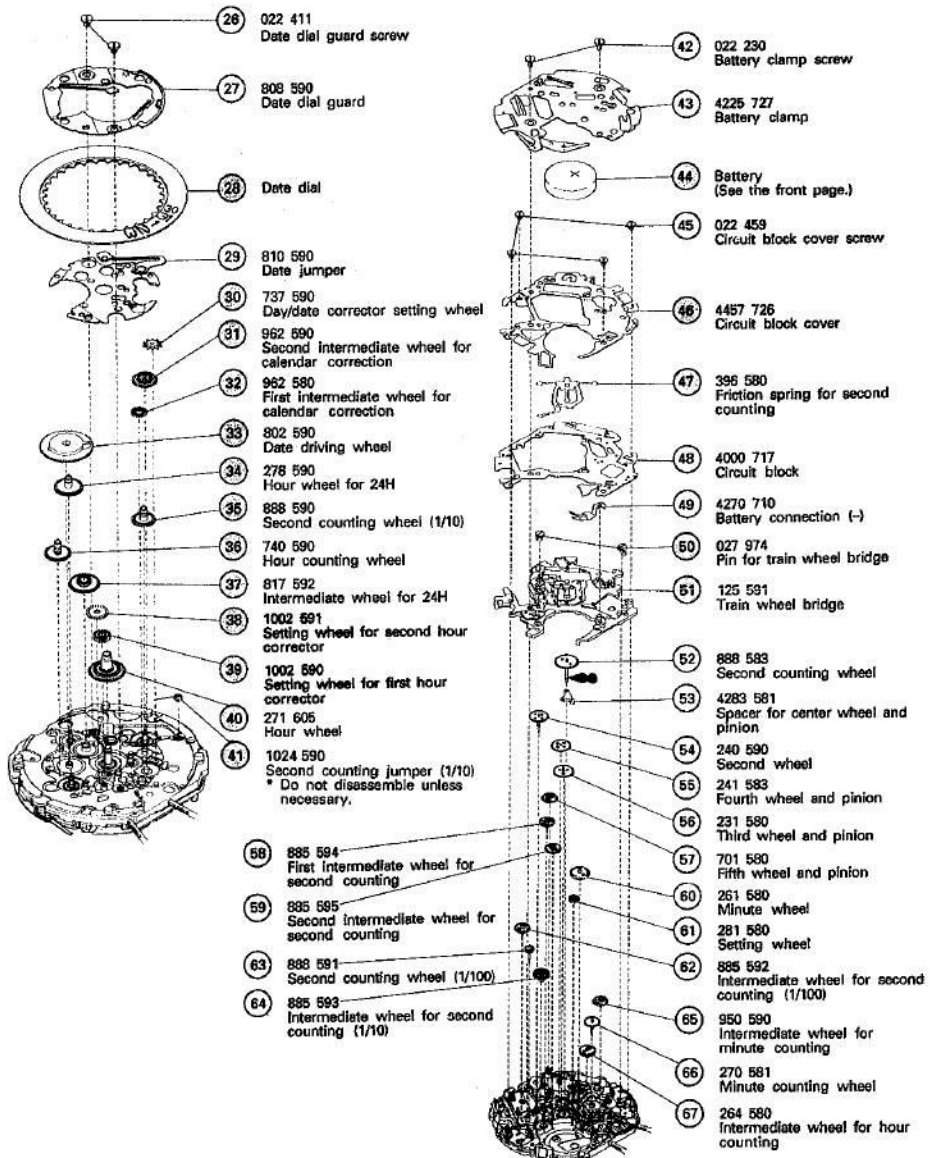

○ ➔ Please see the remarks on the following pages.

PARTS CATALOGUE

Cal. 7T59B

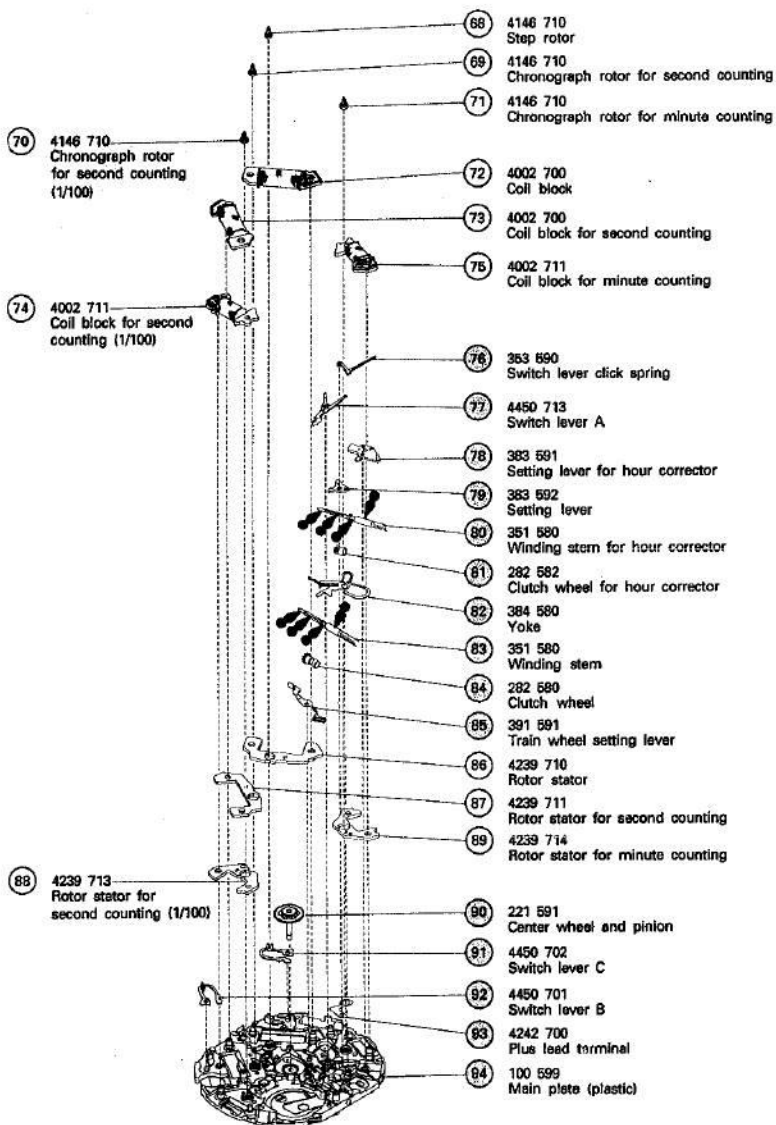

 Please see the remarks on the following pages.



PARTS CATALOGUE

Cal. 7T52B



Disassembling procedures Figs. : 1 → 78

Reassembling procedures Figs. : 78 → 1



Lubricating: Types of oil

-  Moebius A
-  SEIKO Watch Oil S-6
-  Silicone oil 500,000 c.s.

Oil quantity

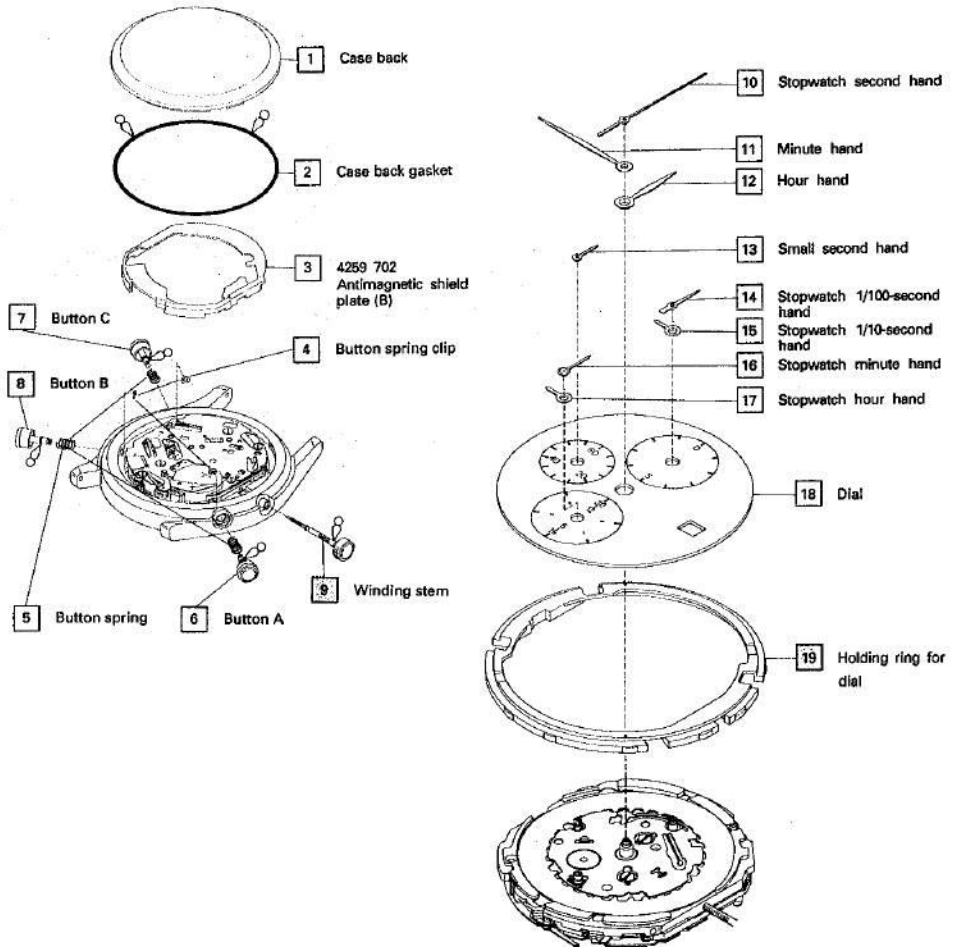
-  Normal quantity
-  Extremely small



  Please see the remarks on the following pages.

PARTS CATALOGUE

Cal. 7T52B

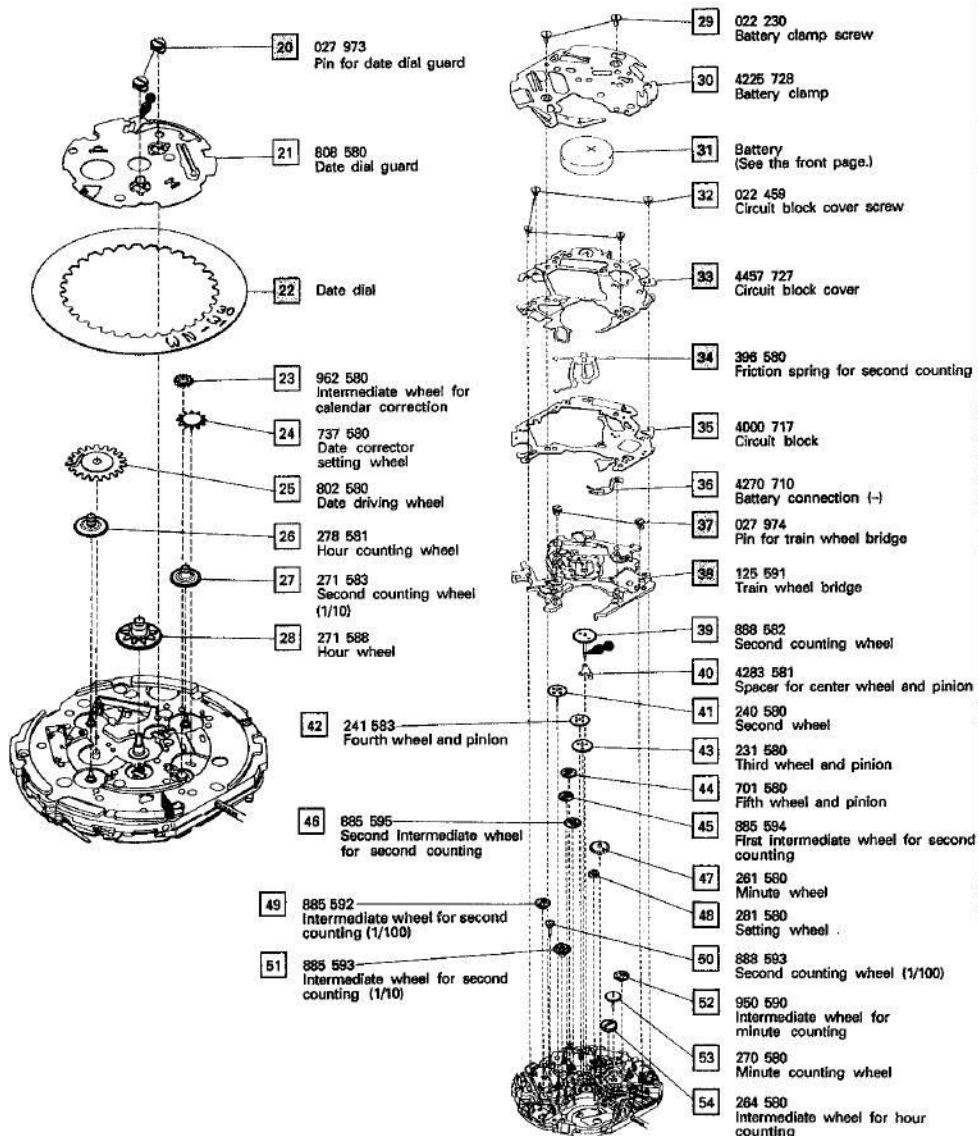

 Please see the remarks on the following pages.

PARTS CATALOGUE

Cal. 7T52B

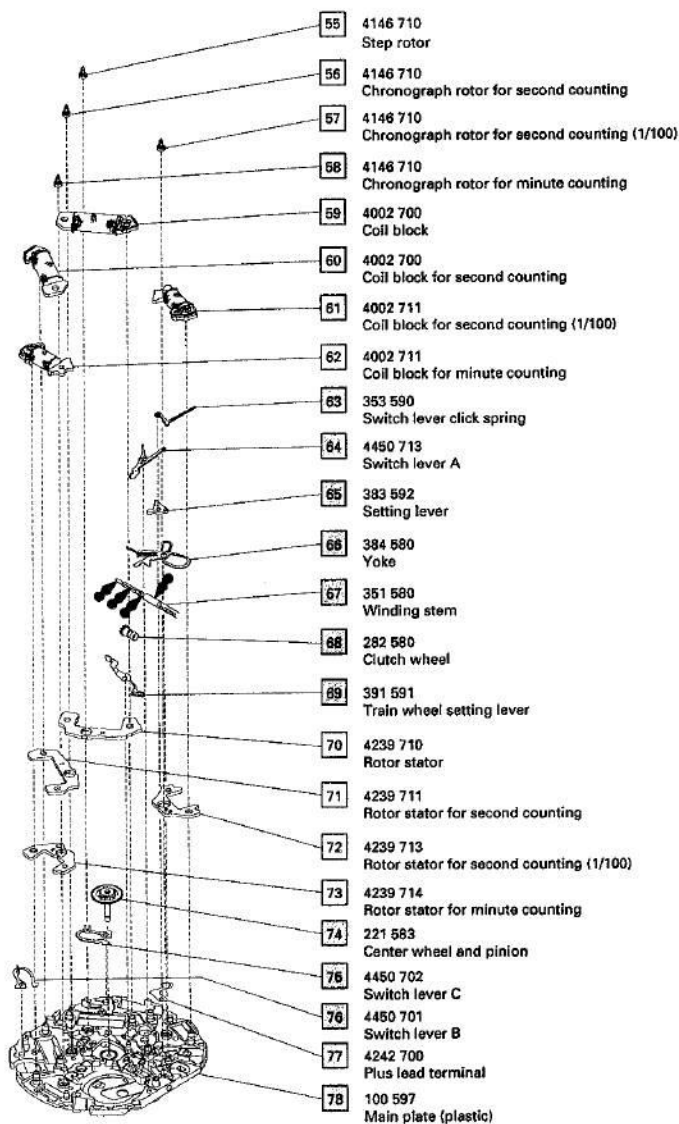

 Please see the remarks on the following pages.

PARTS CATALOGUE

Cal. 7T52B, 7T59B

Remarks

- (21) 19 Holding ring for dial

The type of holding ring for dial is determined based on the design of cases. Check the case number and refer to "SEIKO Casing Parts Catalogue" to choose a corresponding holding ring for dial.

- (22) Pin for day dial guard

- (20) Pin for date dial guard

- (50) 37 Pin for train wheel bridge

For distinction among the pins, see the illustration below.

[Pin for date dial guard
Pin for day dial guard]



[Pin for train wheel bridge]

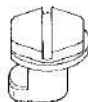

- (24) Day star with dial disk

Part code	Language	Color of figure	Color of background
150 581	English	Black	White
150 586	English	White	Black

If any other type of day star with dial disk is required, please specify the number printed on the disk or refer to the "List of Day Star with Dial Disk".

- (28) 22 Date dial

[Cal. 7T59B]

Part code	Position of crown	Color of figure	Color of background
878 659	3 o'clock	Black	White
878 662		White	Black
878 663		Gold	Black

[Cal. 7T52B]

Part code	Position of crown	Color of figure	Color of background
878 527	3 o'clock	Black	White

The type of date dial is determined based on the design of cases. Check the case number and refer to "SEIKO Casing Parts Catalogue" to choose a corresponding date dial.

PARTS CATALOGUE

Cal. 7T52B, 7T59B

80 Winding stem for hour corrector

83 67 Winding stem

The type of winding stem for hour corrector and winding stem is determined based on the design of cases. Check the case number and refer to "SEIKO Casing Parts Catalogue" to choose a corresponding winding stem for hour corrector or winding stem.

TECHNICAL GUIDE

Cal. 7T52B, 7T59B

- The explanation here is only for the particular points of Cal. 7T52B and 7T59B.
- For the repairing, checking and measuring procedures, refer to the "TECHNICAL GUIDE, GENERAL INSTRUCTIONS".

I. STRUCTURE OF THE CIRCUIT BLOCK

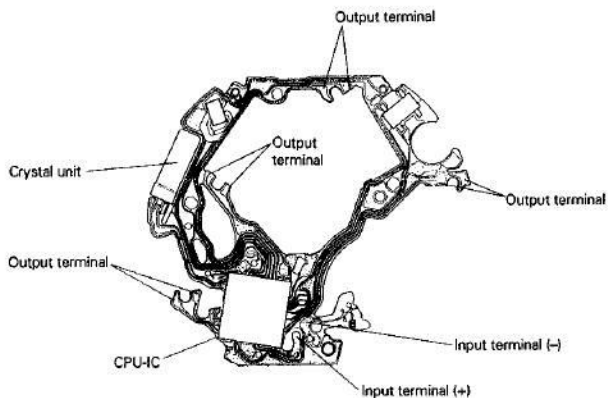

II. REMARKS ON INSTALLING THE BATTERY

- A necessary step after installing the battery
- After the battery is replaced with a new one, or after the battery is re-installed following the repairing procedures, be sure to short-circuit the AC terminal and the circuit block cover with conductive tweezers to reset the circuit as shown in the illustration below.

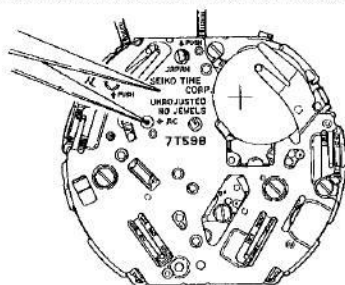

- After resetting the circuit, be sure to reset the stopwatch hands to the 12 o'clock position.

- 1) Pull out the crown at the 3 o'clock side to the second click.
- 2) Press button "A" to reset the stopwatch 1/100-second and 1/10-second hands to "0".
- 3) Press button "B" to reset the stopwatch second hand to "0".
- 4) Press button "C" to reset the stopwatch minute and hour hands to "0".
 - * The stopwatch hour and minute hands turn counterclockwise by pressing button "C".
 - * The hands move quickly by keeping the respective buttons pressed.

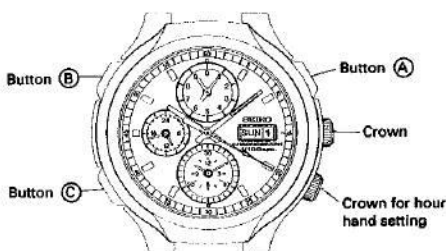

- Demonstration movement of the stopwatch hands

Check the movement of the stopwatch hands following the procedure below.

- 1) Press button "B" to reset the stopwatch hands to the 12 o'clock position.
- 2) Pull out the crown at the 3 o'clock side to the first click.
- 3) Press button "C" for more than 2 seconds. The stopwatch hands start to show the demonstration movement.
 - * The hands will automatically stop the demonstration in 40 seconds.
 - * To stop it manually, push the crown at the 3 o'clock side back in to the normal position or press button "A", "B" or "C".

III. REMARKS ON DISASSEMBLING AND REASSEMBLING

9 Winding stem for hour corrector

10 9 Winding stem

• How to remove

- Winding stem with crown at the 3 o'clock side:

Pull out the crown to the first click, and then push the setting lever by inserting the tip of tweezers into hole "A" in the illustration below.
- Winding stem with crown for hour hand setting at the 4 o'clock side:

With the crown set at the normal position, push the setting lever for hour corrector by inserting the tip of tweezers into hole "B" in the illustration below.

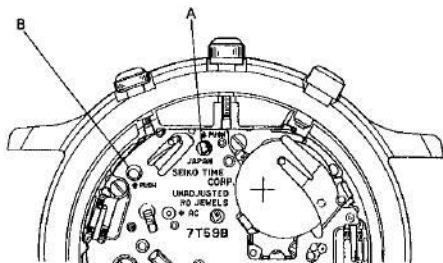

TECHNICAL GUIDE

Cal. 7T52B, 7T59B

• Remarks on setting the winding stems

The winding stems at the 3 o'clock and 4 o'clock sides can be used interchangeably. However, note that the length of winding stem and the type of crown differ depending on the design of cases.

②② Pin for day dial guard

②① Pin for date dial guard

• How to remove

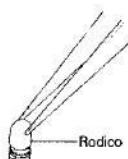
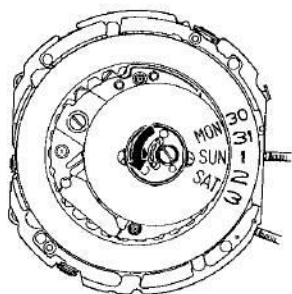

- 1) Turn the pin 90° counterclockwise to loosen it using a screwdriver.
- 2) Pick up the pin using rodico.

• How to install

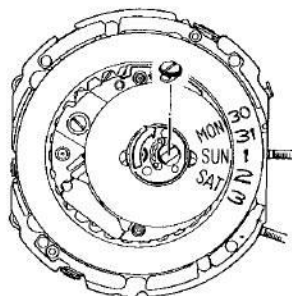

- 1) Set the pin properly into the groove.
- 2) Turn the pin 90° clockwise using a screwdriver to fix it.

Notes:

- Never turn the pin more than 90° clockwise or counterclockwise.
- Never apply undue force to the pin in turning it using a screwdriver.
- Be sure to use a screwdriver that fits in with the slot of the pin head.

• Lubricating (only for Cal. 7T59B)

Lubricate the date jumper as shown in the illustration.

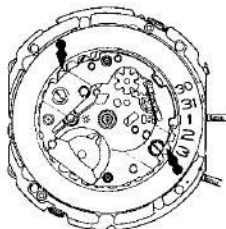

TECHNICAL GUIDE

Cal. 7T52B, 7T59B

③① Day/date corrector setting wheel ~ ④① Hour wheel

• **Setting positions of the wheels for calendar function**

Check the setting positions of the wheels for calendar function referring to the illustration below.

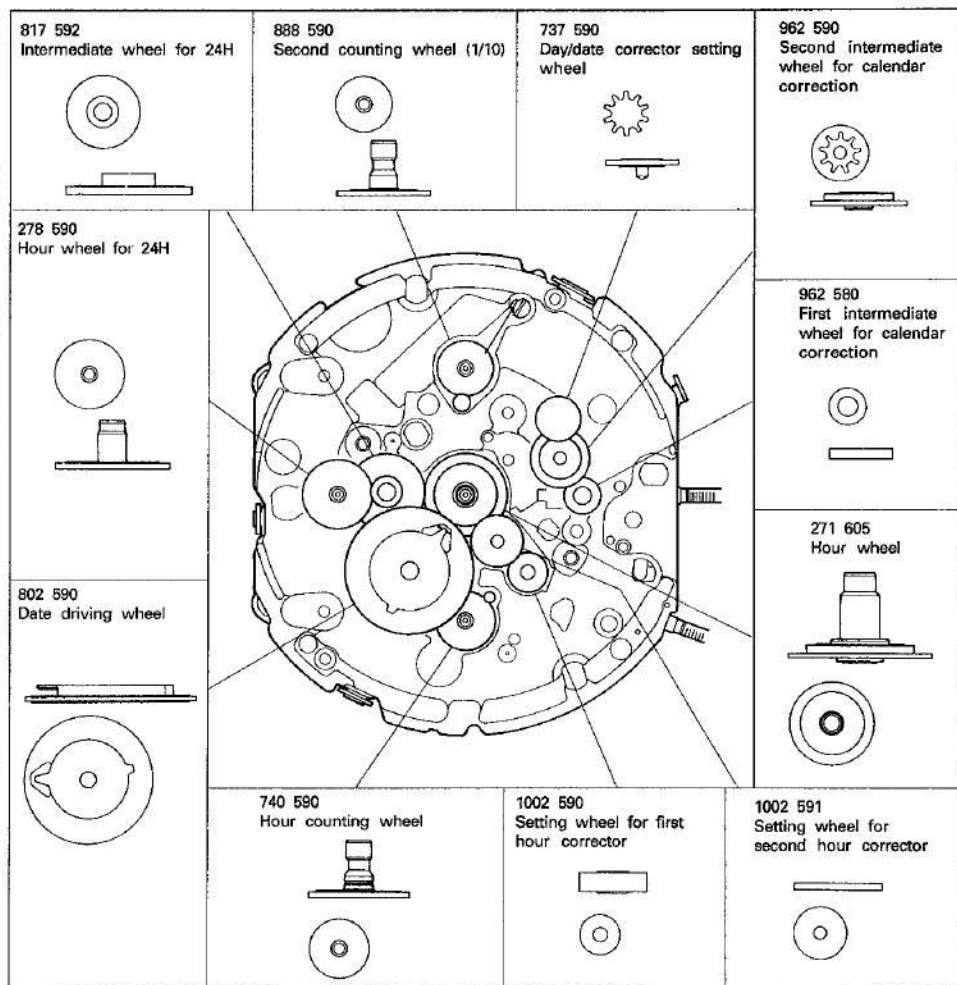

31 Second intermediate wheel for calendar correction

32 First intermediate wheel for calendar correction

40 Hour wheel

• **Lubricating**

Lubricate the hour wheel jumper, first intermediate wheel for calendar correction and second intermediate wheel for calendar correction as shown in the illustrations.

Hour wheel jumper



First intermediate wheel for calendar correction



Second intermediate wheel for calendar correction



41 Second counting jumper (1/10)

- Do not disassemble the second counting jumper.
- Turn the second counting jumper with a screwdriver so that its spring is set at the position indicated by the arrow in the illustration.

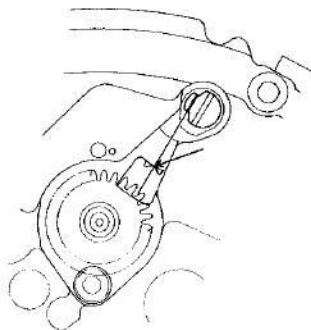

44 31 Battery

• **Remarks on installing**

After installing the battery, be sure to reset the circuit with tweezers as shown in the illustration.

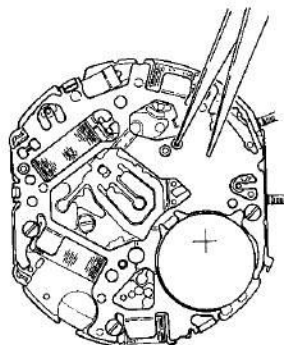

46 33 Circuit block cover

• How to remove

- 1) Loosen the four screws and remove them.
- 2) Release the click portion of the setting lever for hour corrector (only for Cal. 7T59B)
- 3) Release the three hooking portions of the circuit block cover by prying them up with the tip of a screwdriver as shown in the illustration at right.



• Installing and lubricating

- 1) Set the hooking portion ①.
- 2) Check that the circuit block cover is securely set to the guide tube (a) and (b).
- 3) Set the hooking portions in the order of ② and ③ in the illustration.
- 4) Tighten the screw (c).
- 5) Hook the yoke spring (d).
- 6) Tighten the other three screws.
- 7) Lubricate the click portion of the setting lever for hour corrector. (only for Cal. 7T59B)

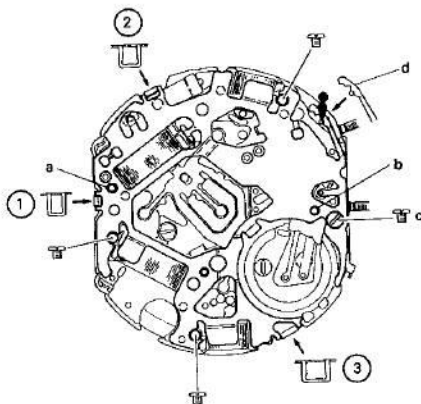

(The illustration refers to Cal. 7T59B.)

47 34 Friction spring for second counting

• Setting position

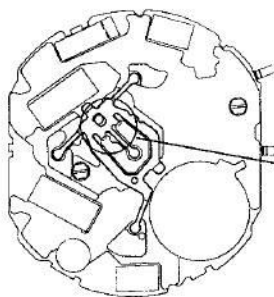

Enlarged

Slip the friction spring for second counting into the gap under the train wheel bridge.

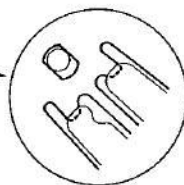

50 37 Pin for train wheel bridge

• **How to remove**

Turn the pins 90° counterclockwise to loosen them, and pick them up using rodico.

• **How to install**

Set the pins properly into the groove as shown in the illustration, and turn them 90° clockwise with a screwdriver to fix them.

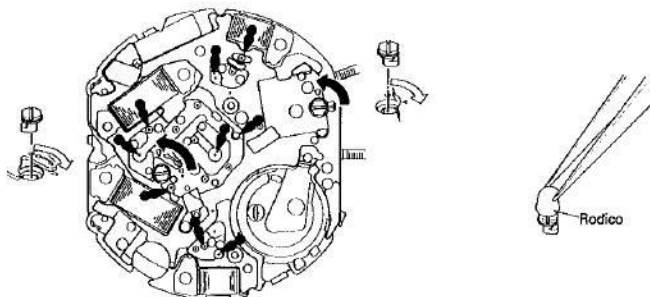

• **Lubricating of the upper pivots for wheels and rotors**

After installing the train wheel bridge, lubricate the step rotor, chronograph rotor for minute counting, chronograph rotor for second counting, chronograph rotor for second counting (1/100), minute wheel, minute counting wheel, second counting wheel (1/100), second counting wheel and second wheel.

- Notes:**
- Never turn the pins more than 90° clockwise or counterclockwise.
 - Never apply undue force to the pins in turning them using a screwdriver.
 - Be sure to use a screwdriver that fits in with the slot of the pin head.

TECHNICAL GUIDE

Cal. 7T52B, 7T59B

51 38 Train wheel bridge

• Remarks on installing

- Before installing the train wheel bridge, check if the wheels are set in the proper position, referring to the illustration below. Also, check their lower pivots are securely set in the axle holes.

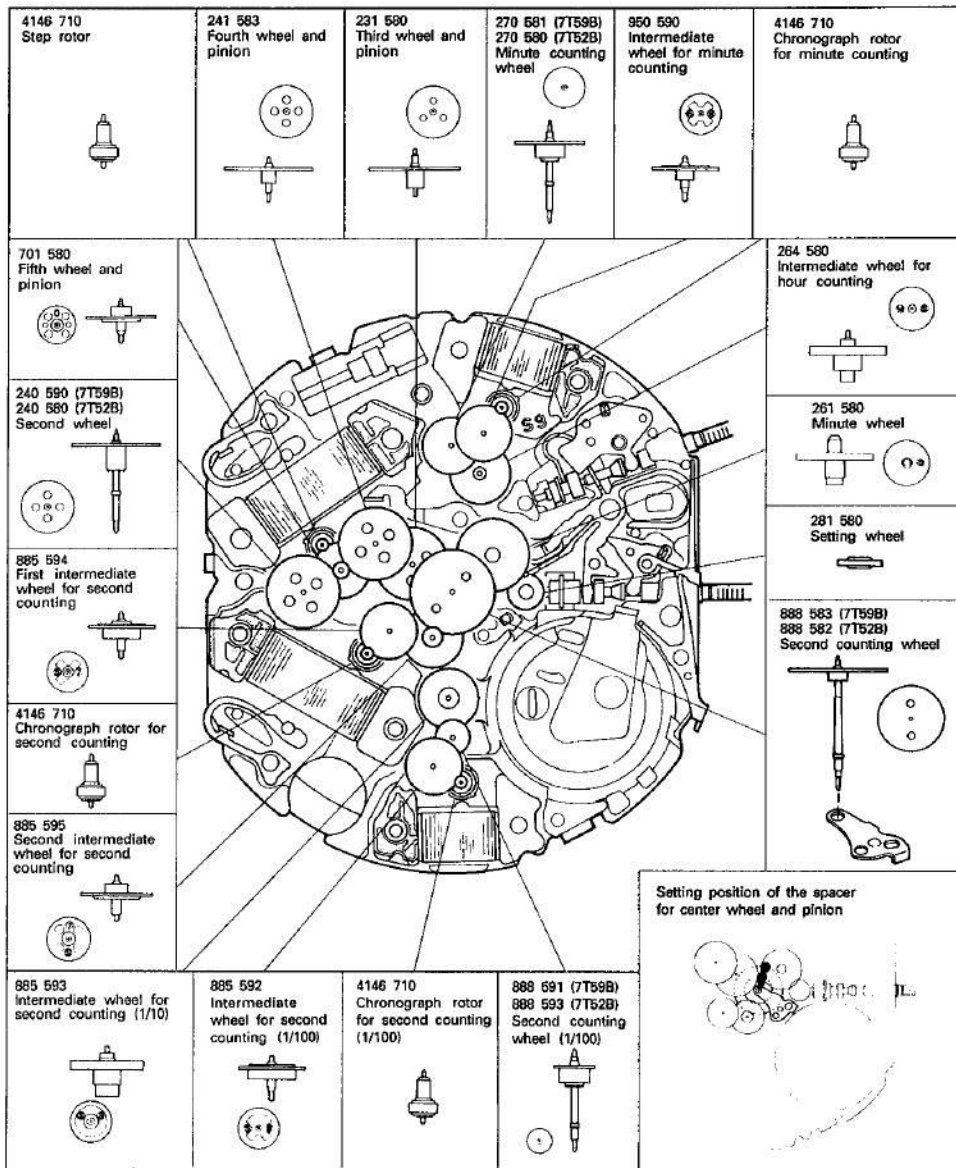

76 Switch lever click spring ~ 85 Train wheel setting lever

63 Switch lever click spring ~ 69 Train wheel setting lever

• **Setting position and lubricating**

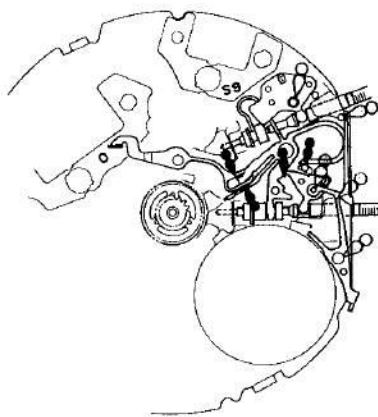

90 74 Center wheel and pinion

• **Lubricating**

Lubricate the center wheel and pinion as shown in the illustration.



91 Switch lever C ~ 93 Plus lead terminal

75 Switch lever C ~ 77 Plus lead terminal

• **Setting position**

Set the switch levers B and C and the plus lead terminal as shown in the illustration.

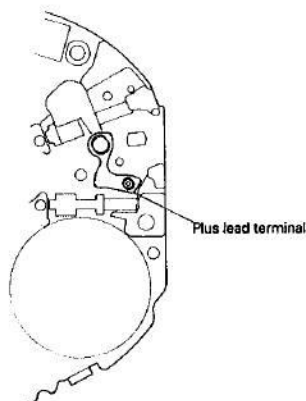
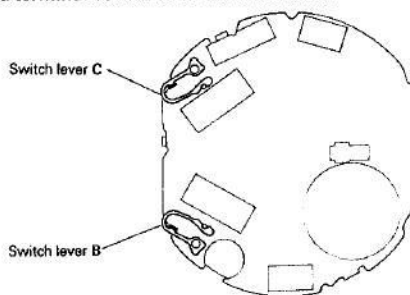

TECHNICAL GUIDE

Cal. 7T52B, 7T59B

94 78 Main plate

• Lubricating

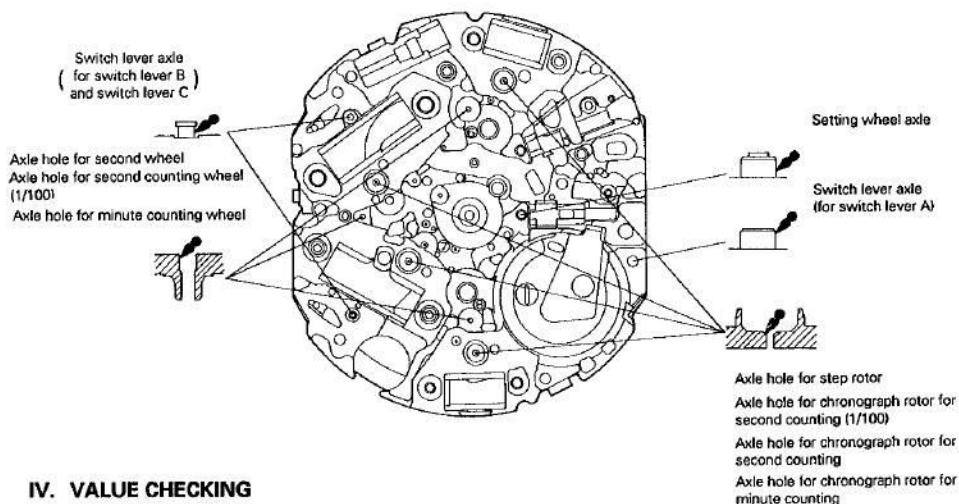

IV. VALUE CHECKING

• Coil block resistance

Coil block for second counting (1/100) :	1.8K Ω ~ 2.4K Ω
Coil block for minute counting :	1.8K Ω ~ 2.4K Ω
Coil block for second counting :	1.7K Ω ~ 2.3K Ω
Coil block :	1.7K Ω ~ 2.3K Ω

• Current consumption

Before measuring current consumption, be sure to reset the circuit.

* Refer to "A necessary step after installing the battery".

For the whole of the movement :	less than 2.5 μ A
For the circuit block alone :	less than 1.8 μ A

• Time accuracy

Before measuring the accuracy, be sure to reset the stopwatch to "0".