

1

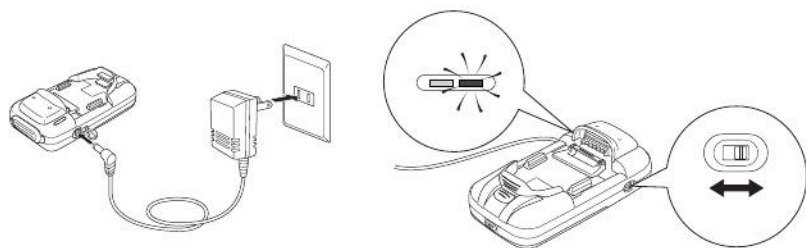

2

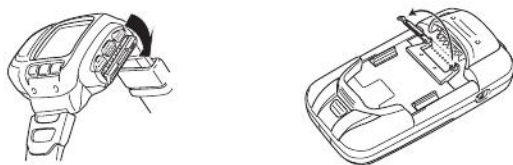

3

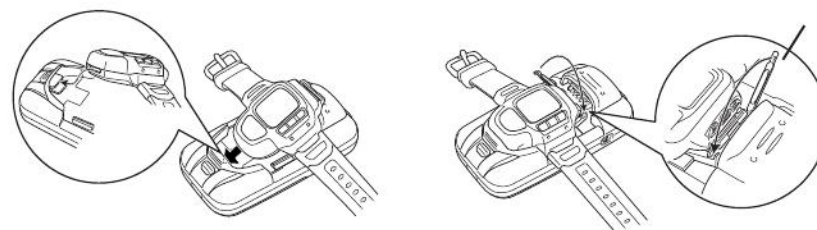

4

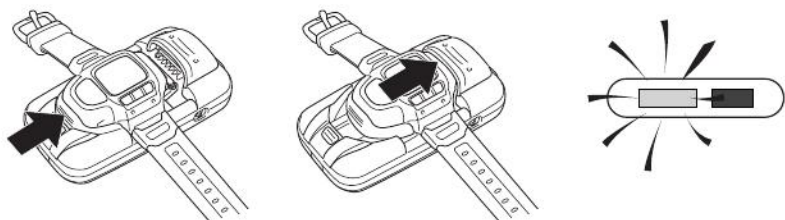

1

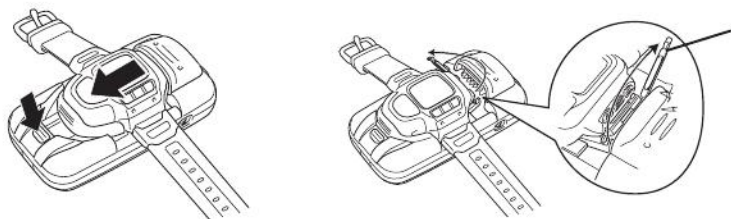

2



3

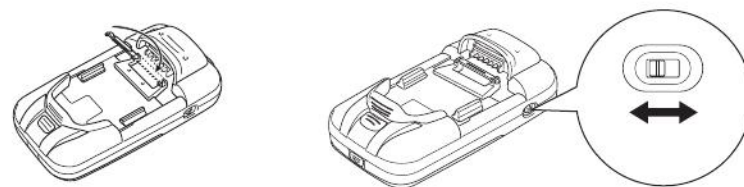

1

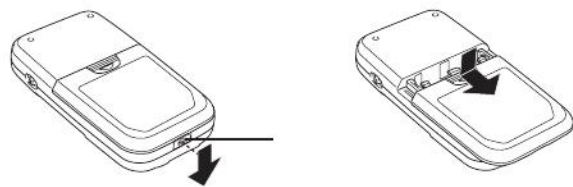

2

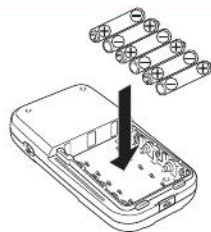

3

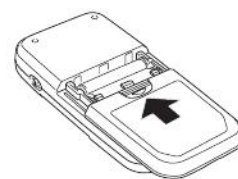

4



2

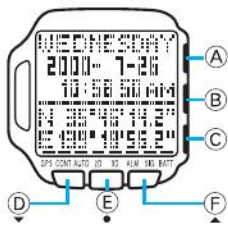
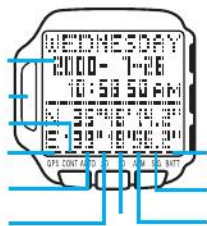

- Ⓐ
- Ⓑ
- Ⓒ
- Ⓓ
- Ⓔ
- Ⓕ

Ⓕ

Ⓐ

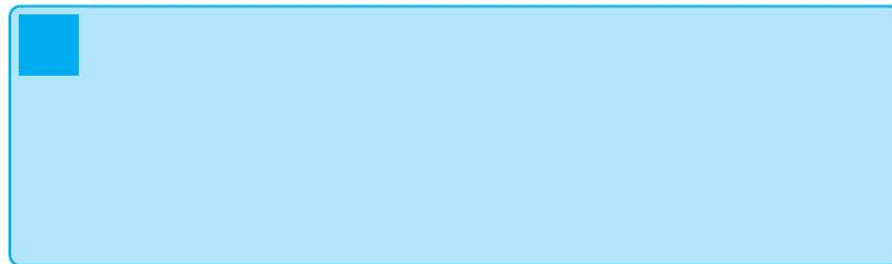

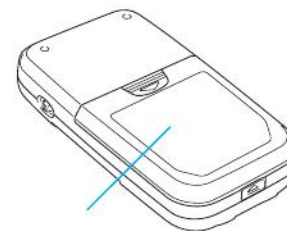
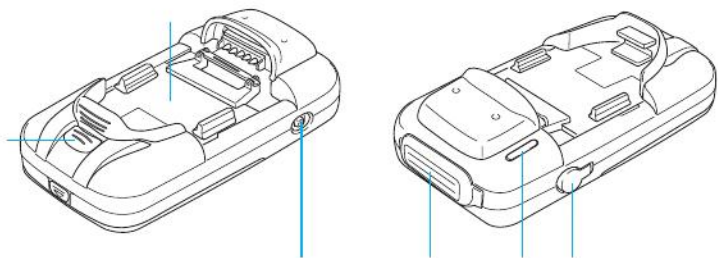

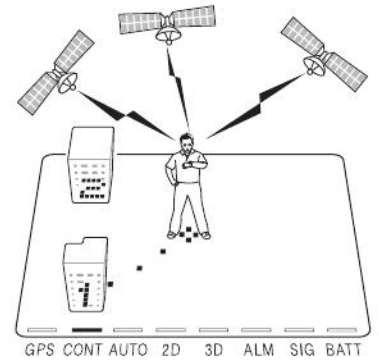

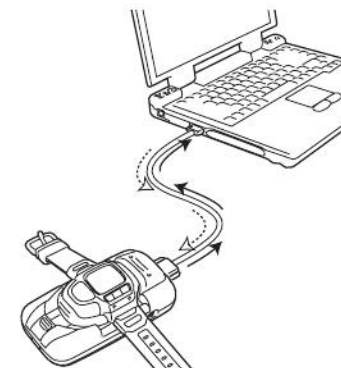
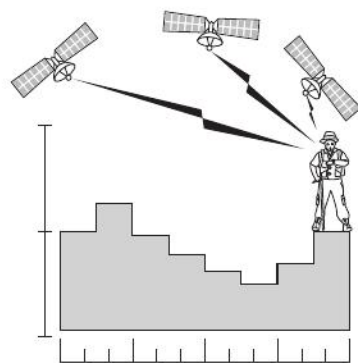
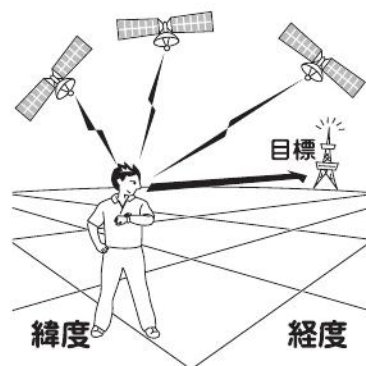

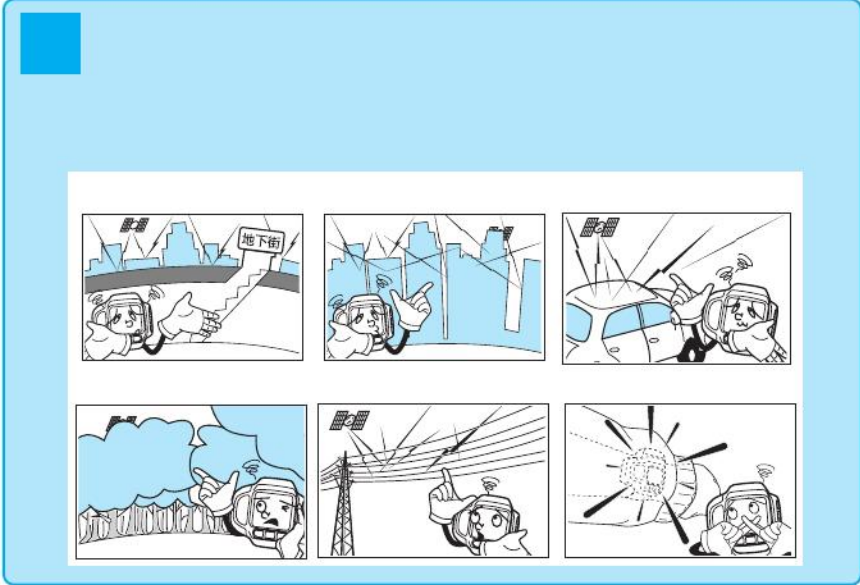
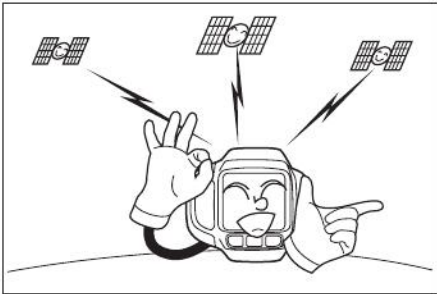

E

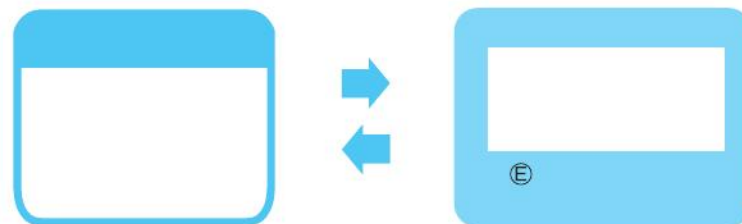

Ⓐ

Ⓑ

Ⓒ

Ⓐ					
Ⓒ					
Ⓔ					
Ⓕ					
Ⓖ					

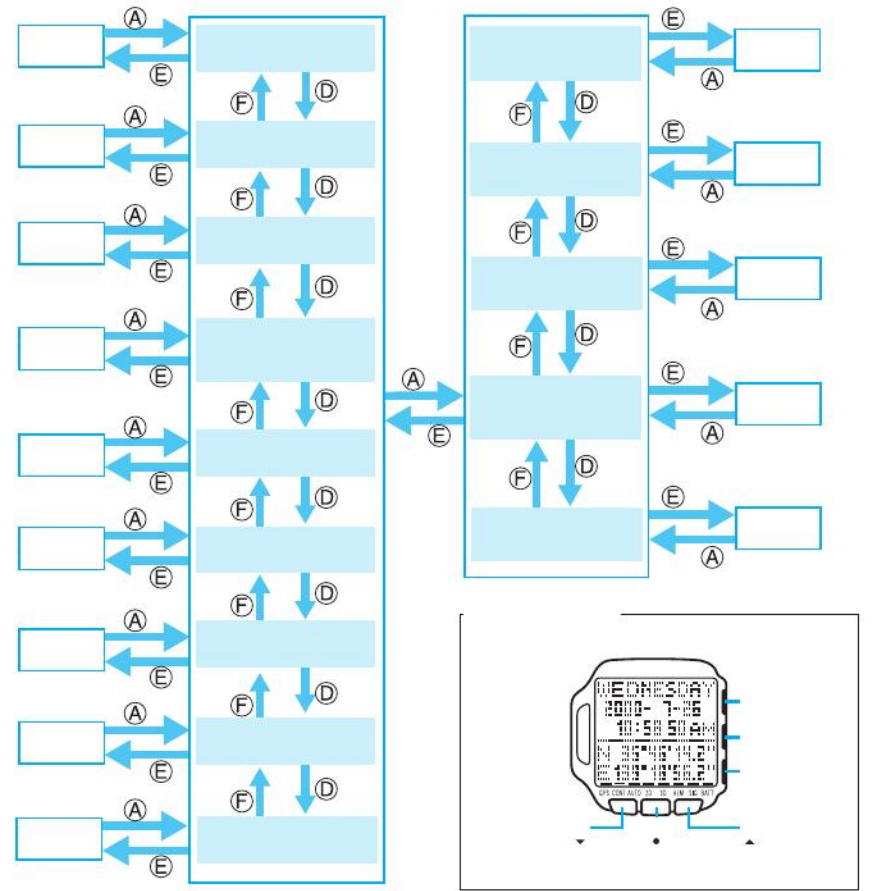
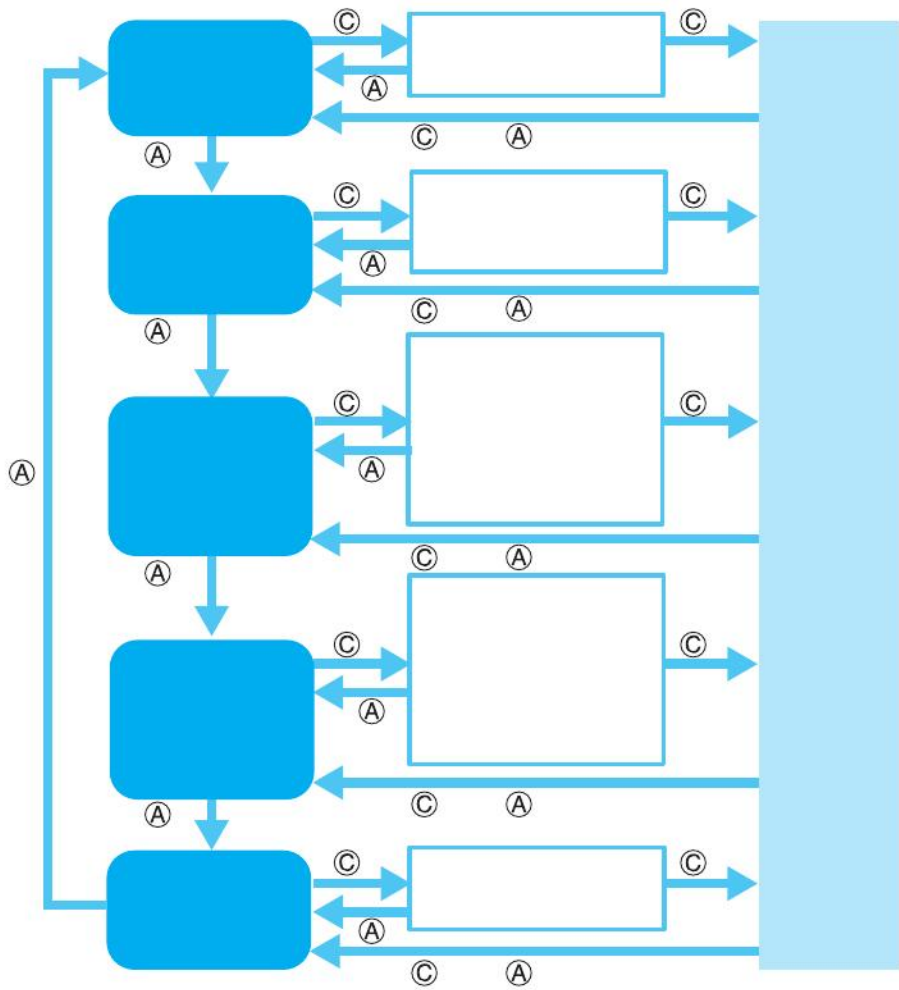



Ⓧ

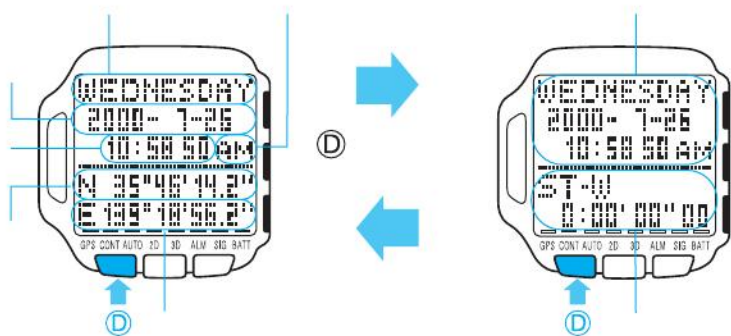

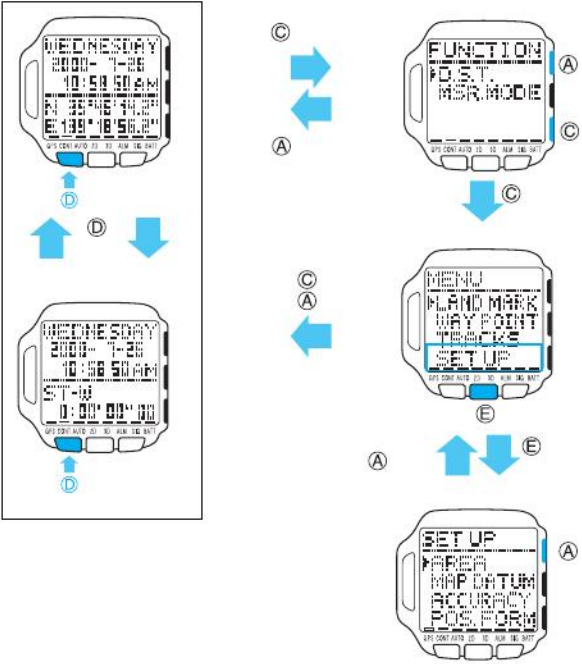





1

C

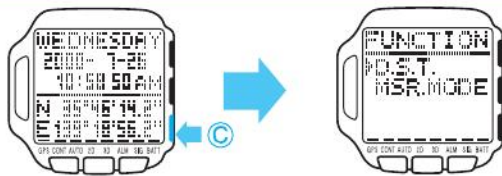

2

C

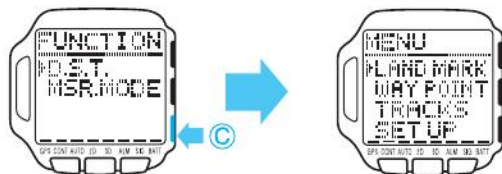

3

F

D

E



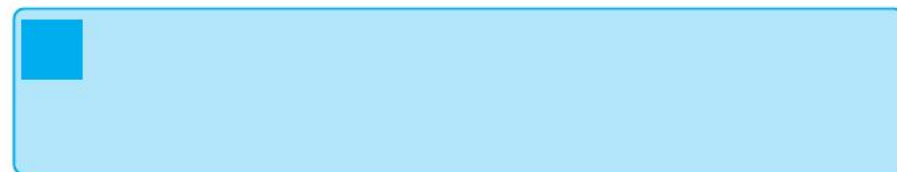
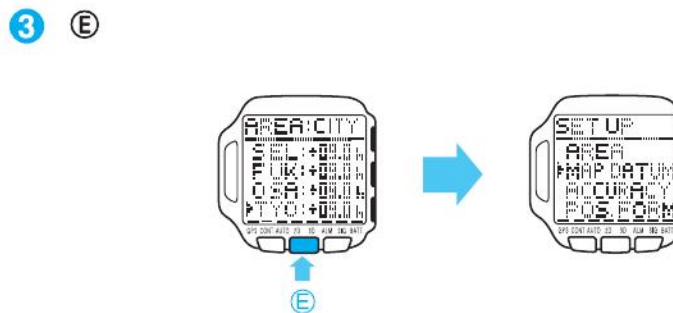
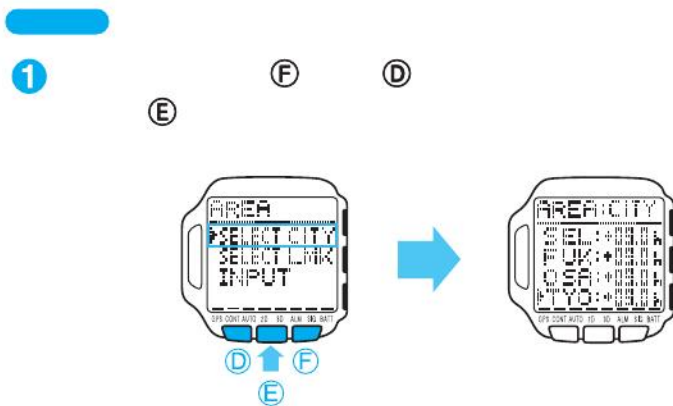
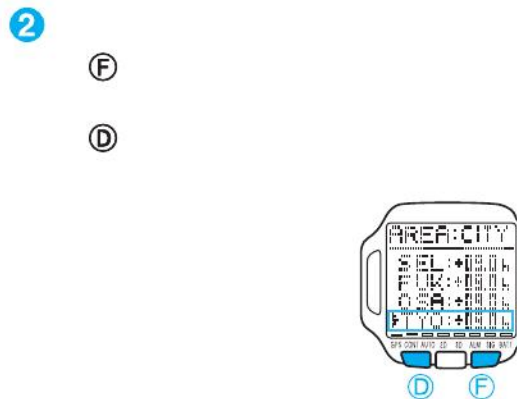
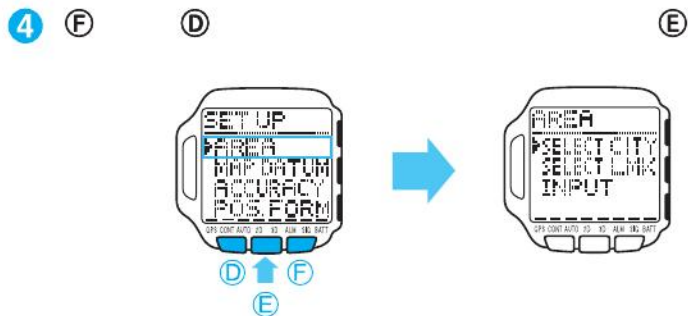



1

E F D

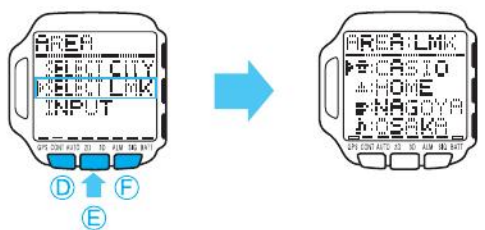

2

F D



3 E

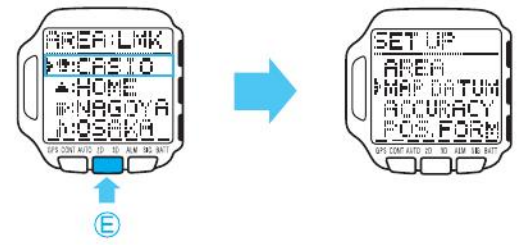

2 A
2 C



1

F

D

E

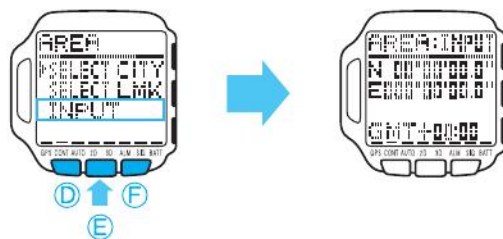

2

A

A

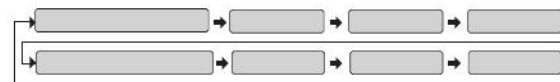

F

D



3 (E)

(F)

(D)

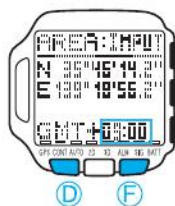

4 (E)

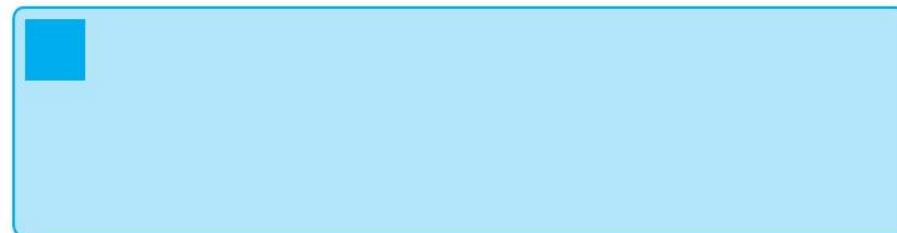
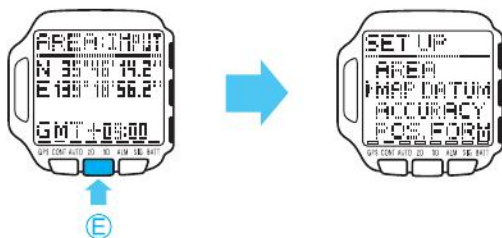

1

C

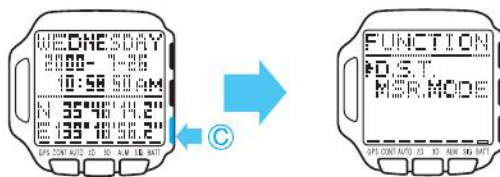
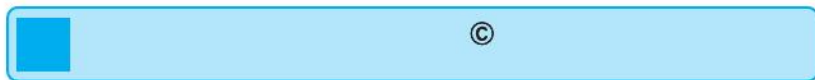

2

C

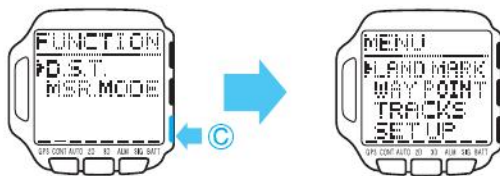

3

F

D

E

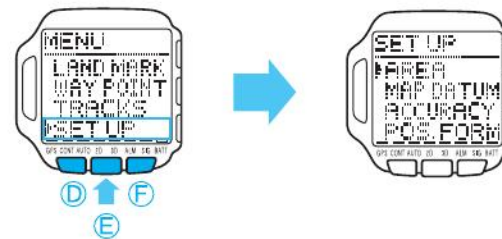

4

F

D

E

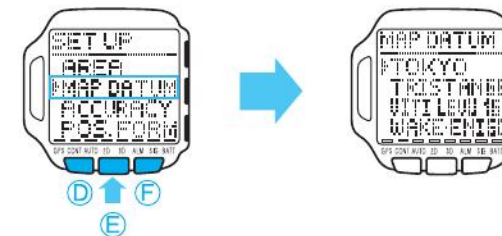



1

F

D

F

D



2 E







1

E

F

D



2

D

F

E



3

A



F

D

E

C



2 3

4

E

F

D

E



E

1

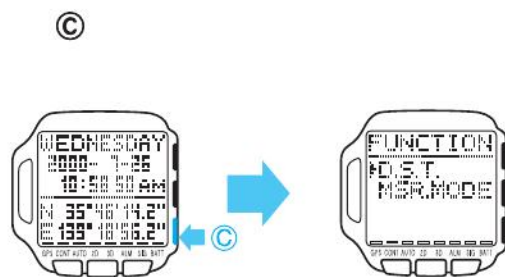

2 C

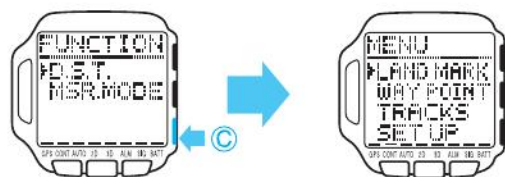

3 F D

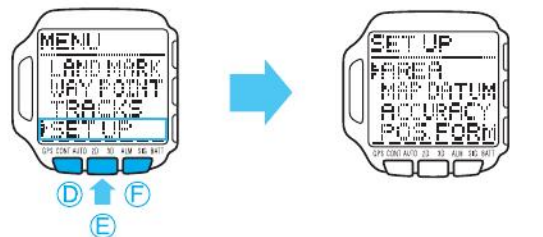

4 F D

D

E

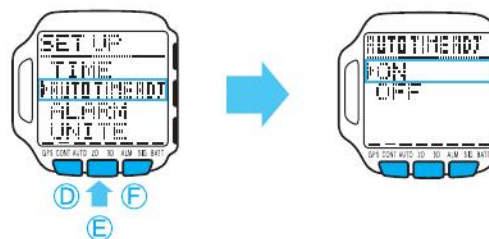

5 E D

D

E

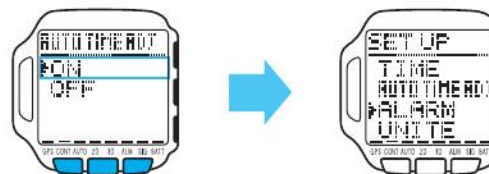

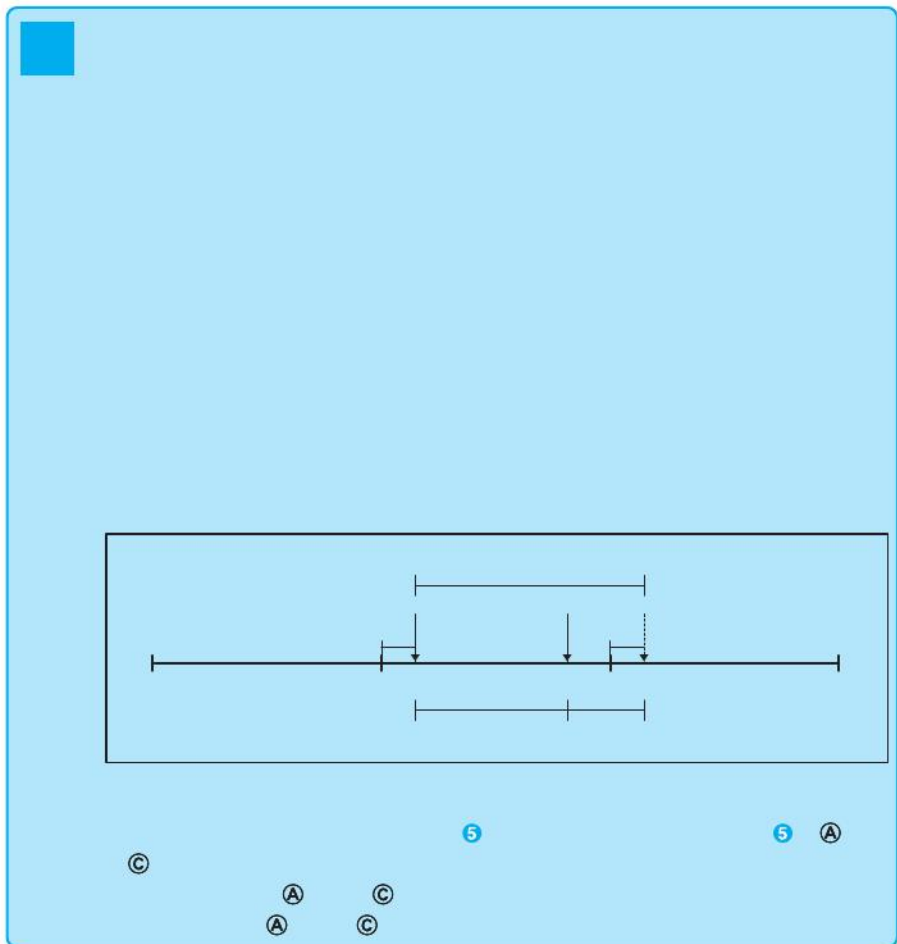

1

C



2

C



3

F

D

E



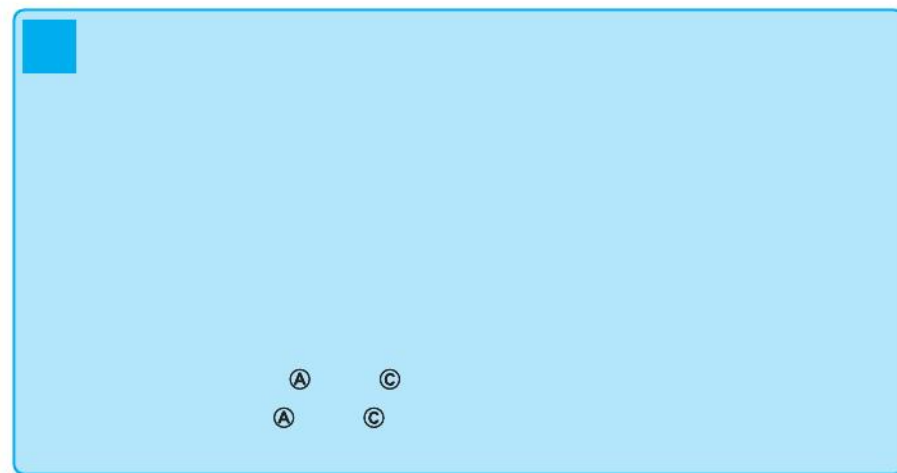
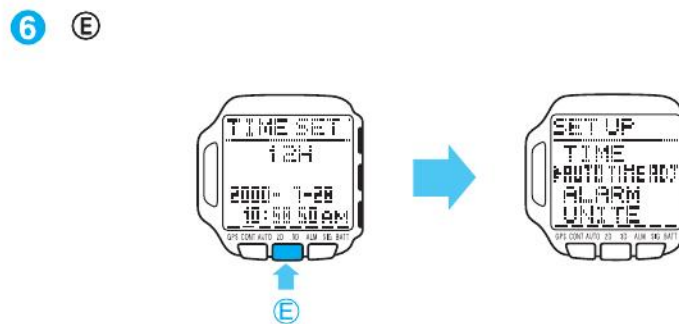
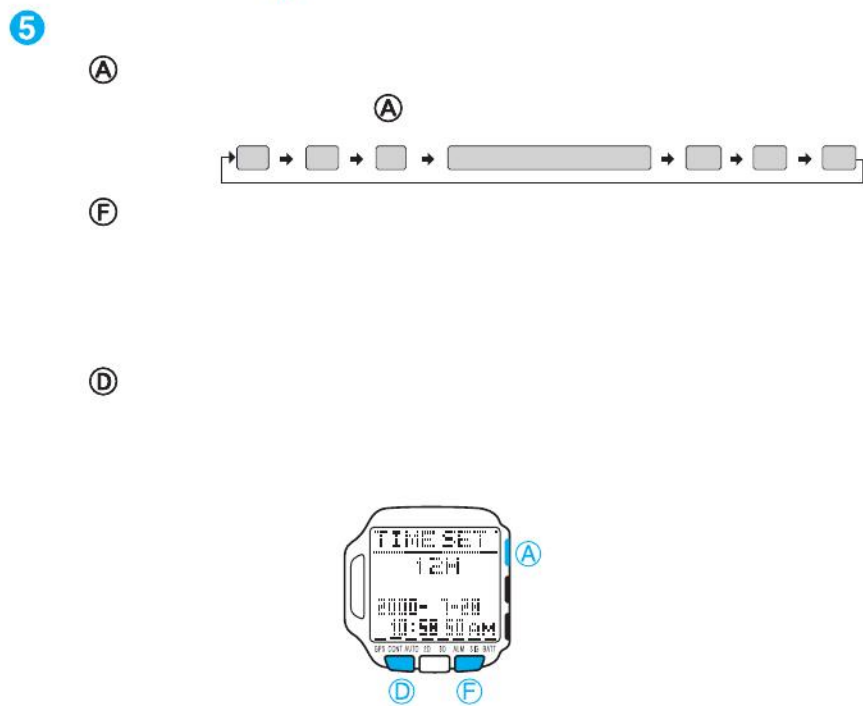
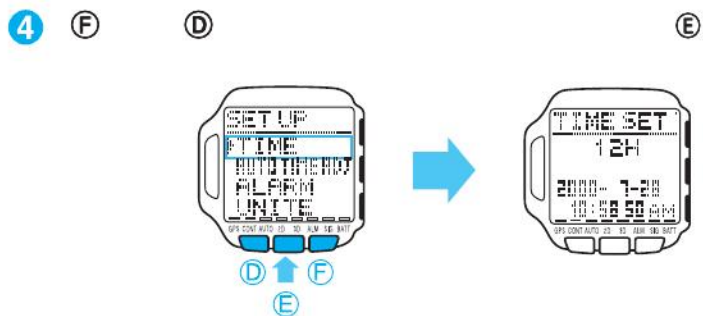

E



1

C

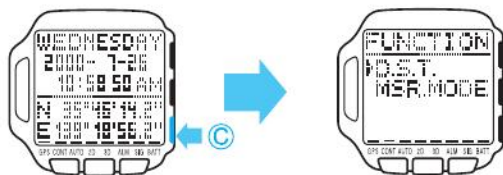

2

F

D

E

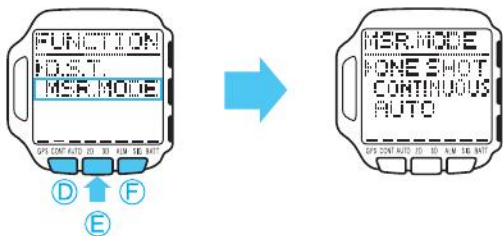

3

F

D



E

5

E

5

4

E

4

E

F

D



5 ⑤

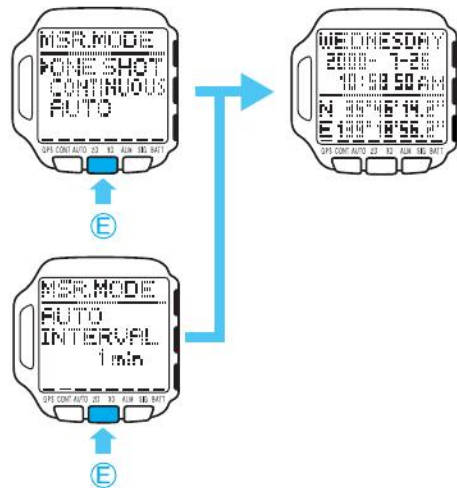

1

⑥

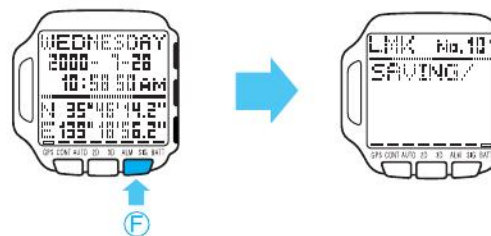

⑦

③

⑥

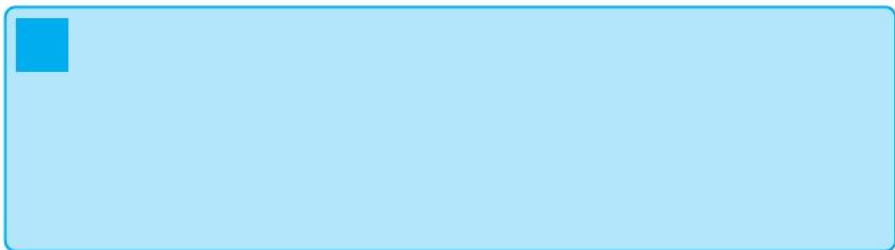

1

C

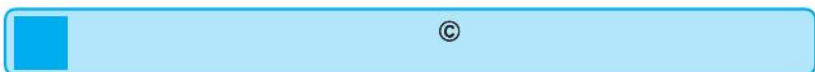

C

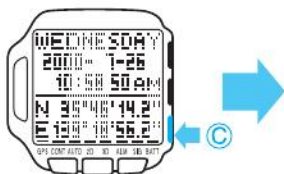

C

2

C



C

3

F

D

E



D ↑ F
E



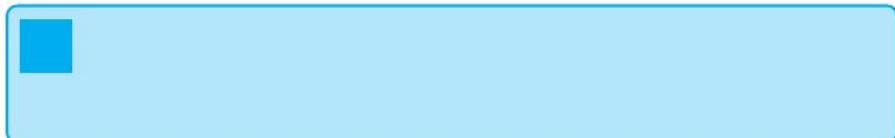

1

F

D

C

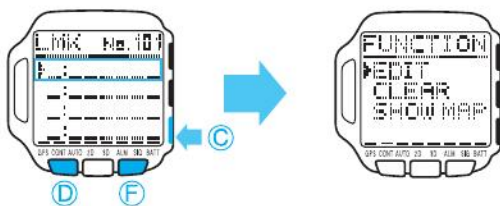

2

F

D

E

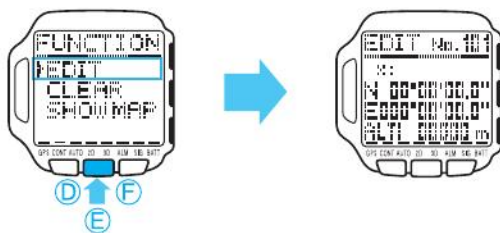

3

4

F

D



4

E

5

F

D

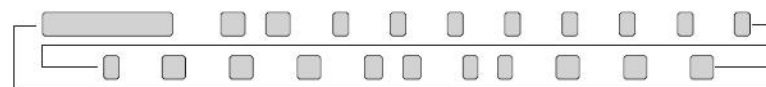

A

A

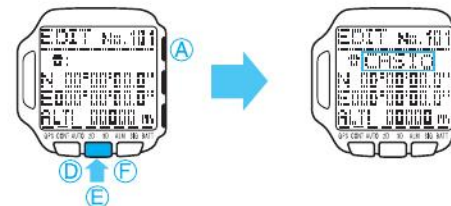

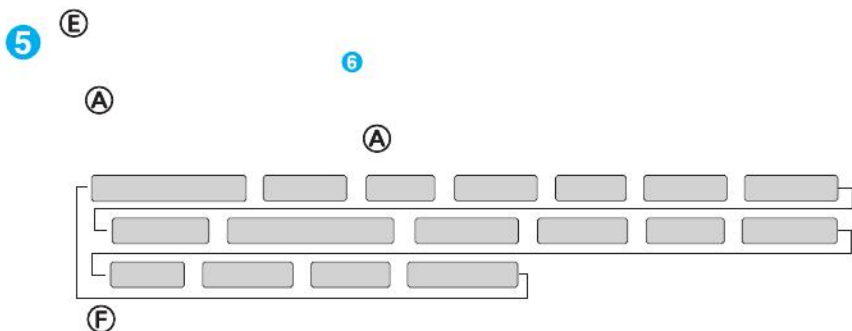

F

D

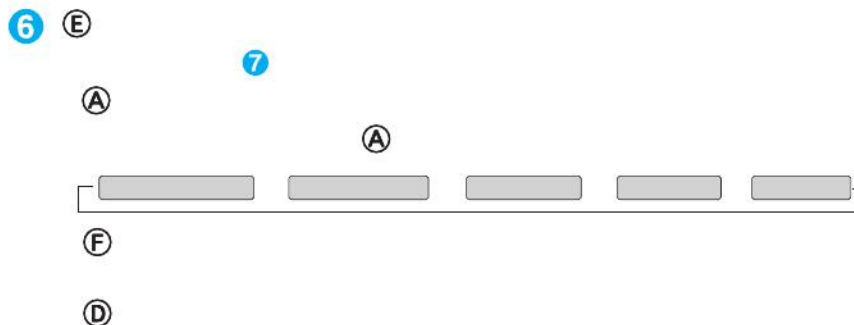
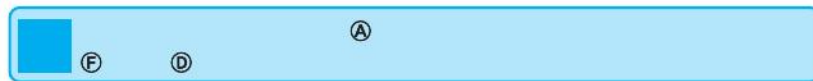
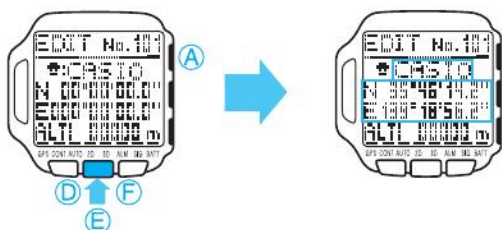

F

D

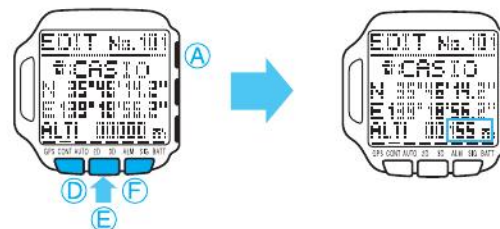

7



E

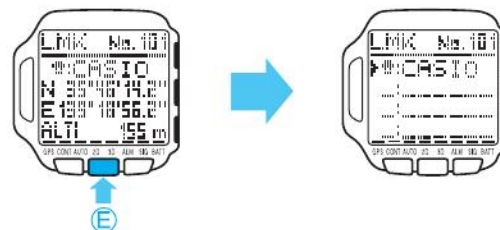

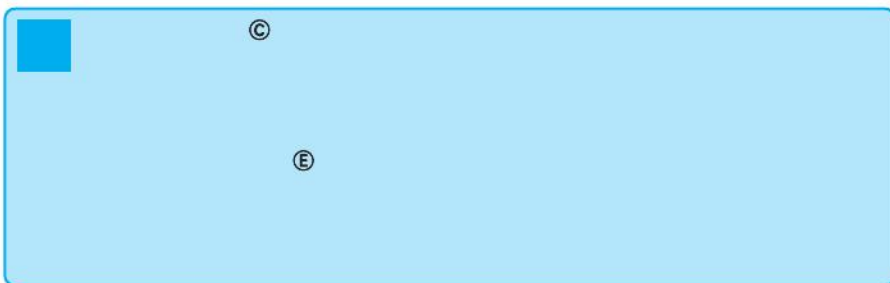
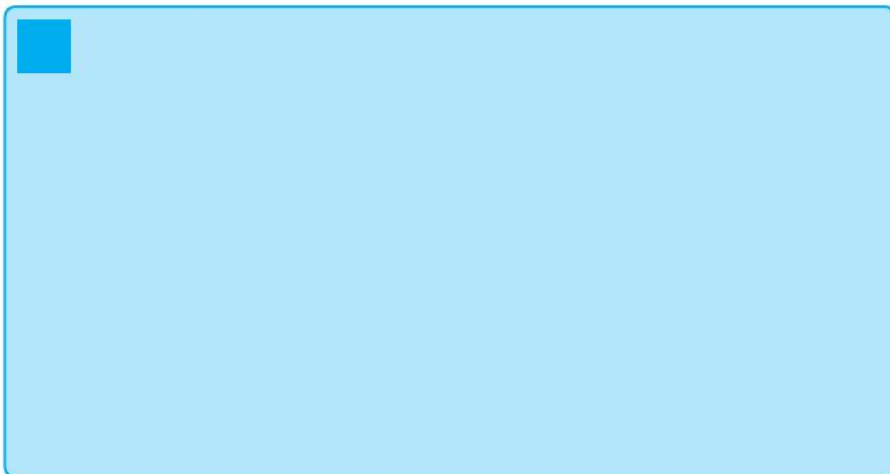

1

C

F

D

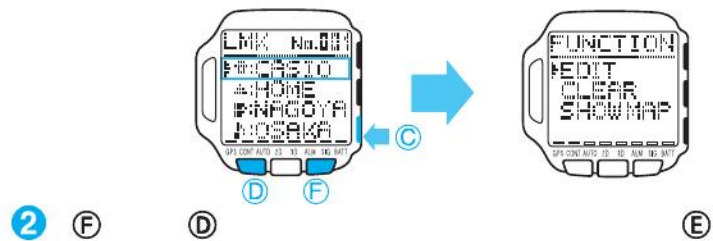

2

F

D

E

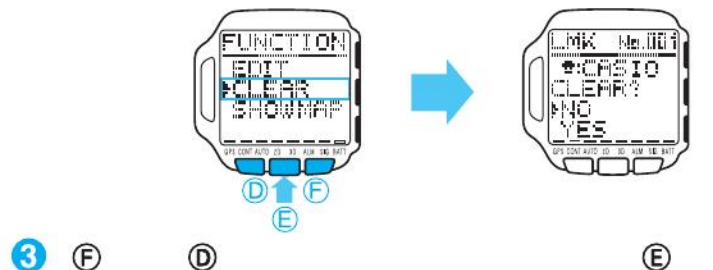

3

F

D

E

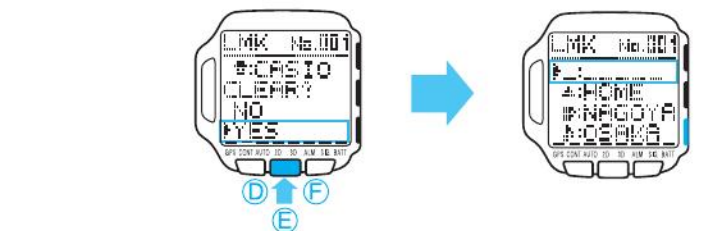

3

E



1

C

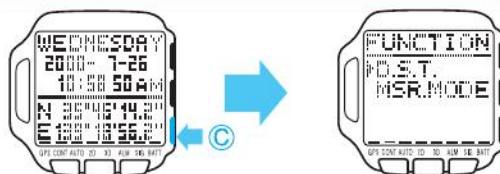

2

C

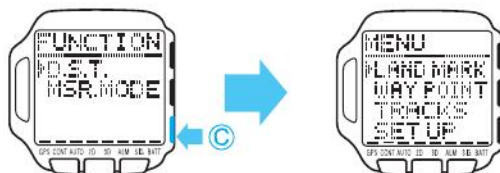

3

F

D

E

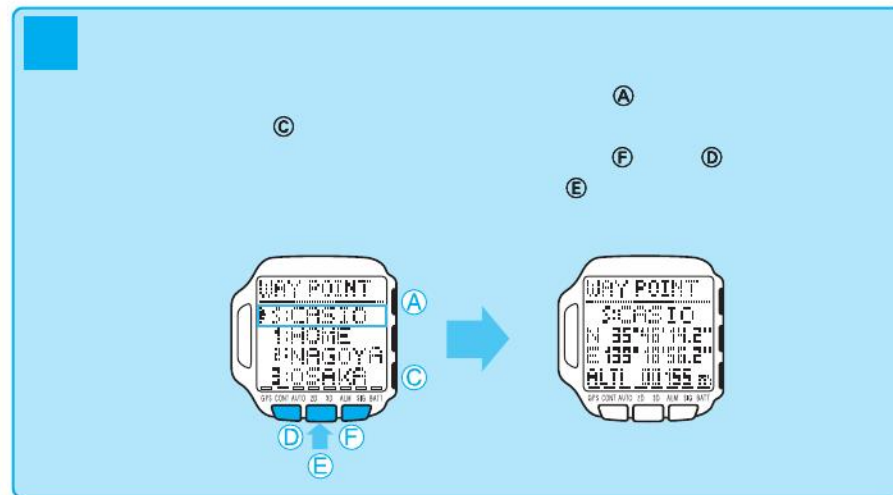
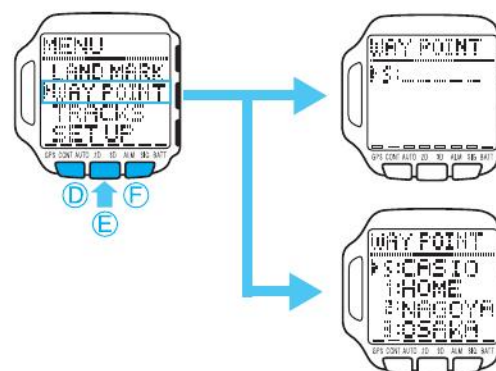

1

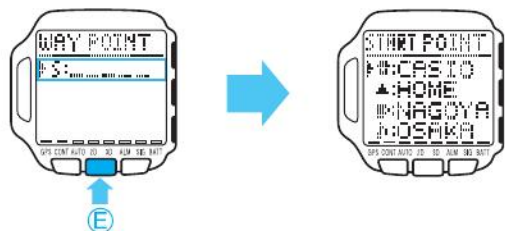

E

2

F

D

E

F

D

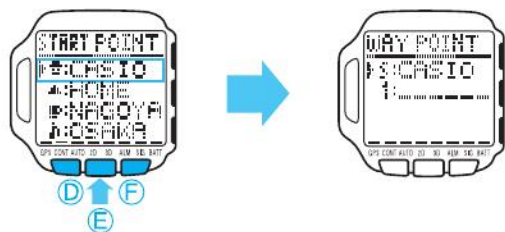

3

F

D

E

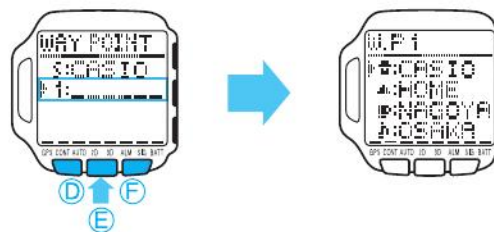

4

F

D

E

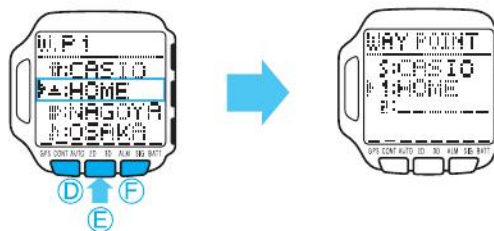

5

3

4

6

A

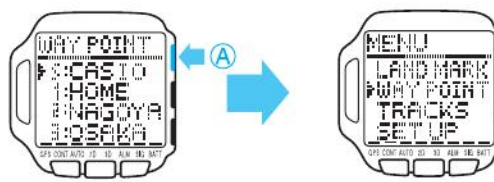



4 (F) (D) (E)

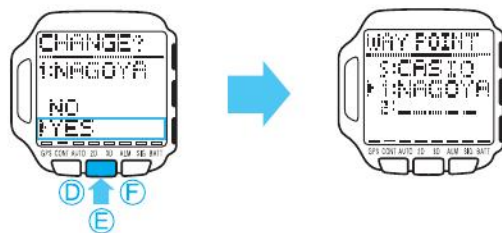

5 (A)

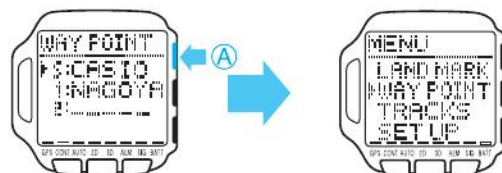

1 (F) (D)

(C)

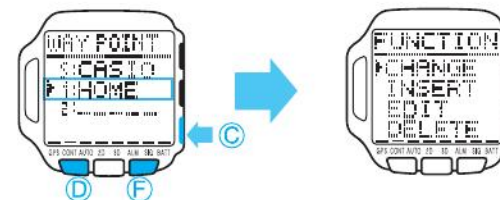

2 (F) (D)

(E)

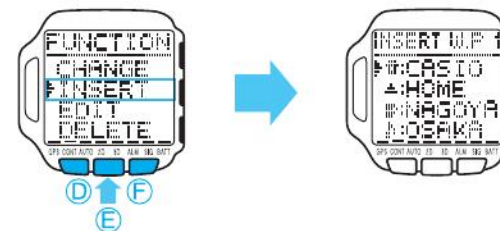

3 F D E

F

D

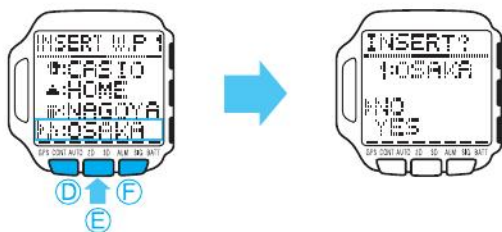

4 F D E

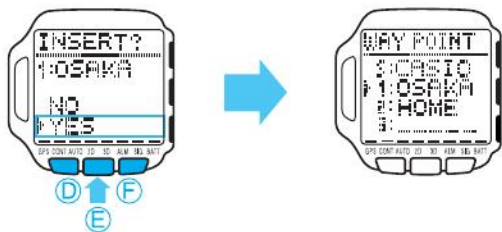

5 A

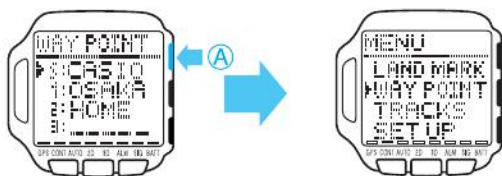

E



1

F

D

C

2 F D E

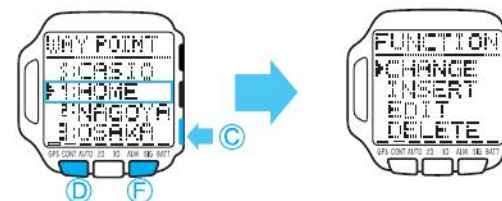

D E

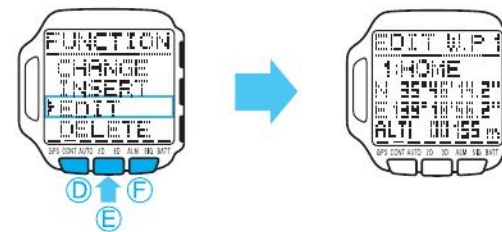

3

4

5

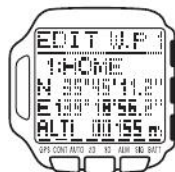

6

4

E

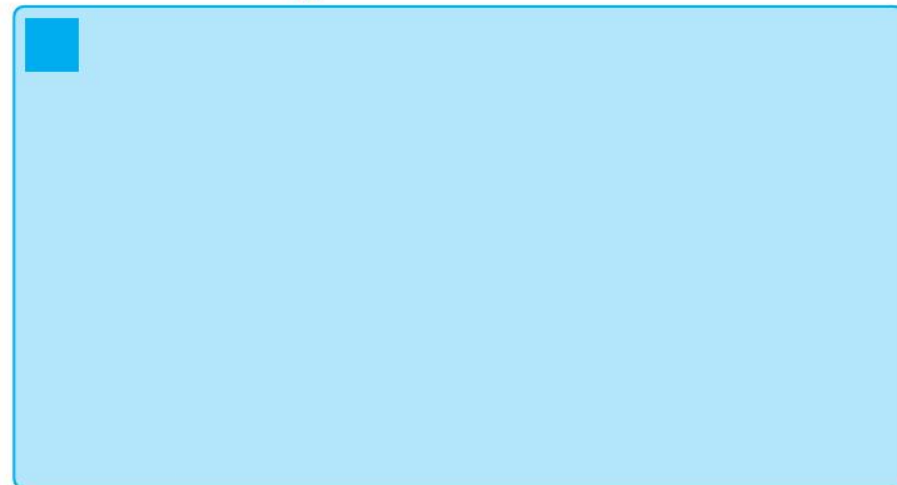



1

F D C

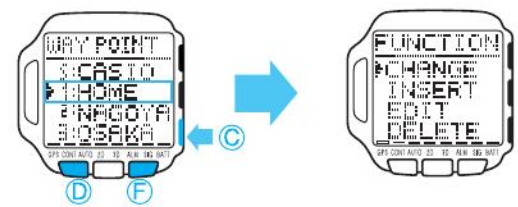

2

F D E

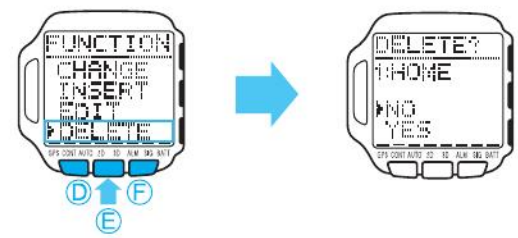

3

F D E

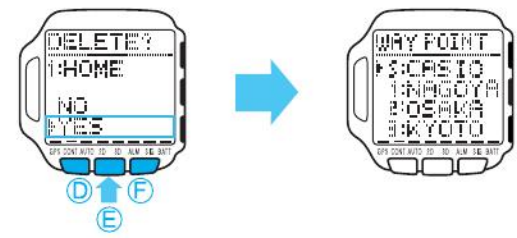

4

A

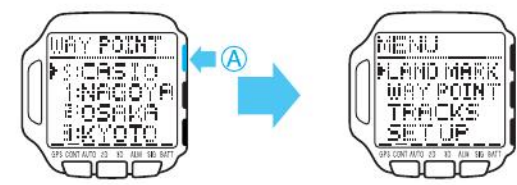

1



2

F

D



3

F

D



4

A



1

C

F

D

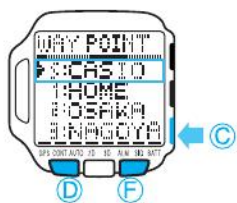

2

F

D

E

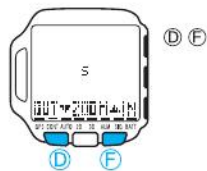

3

E

A

C





Ⓔ

Ⓔ



①

Ⓔ

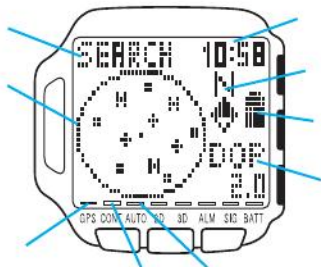

2

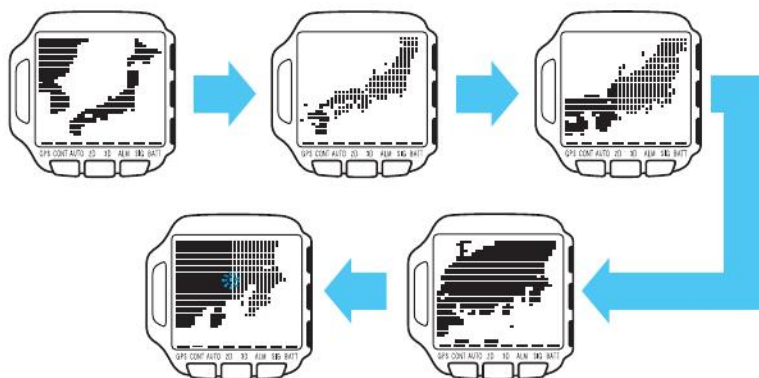

3



4



F D

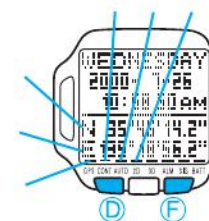

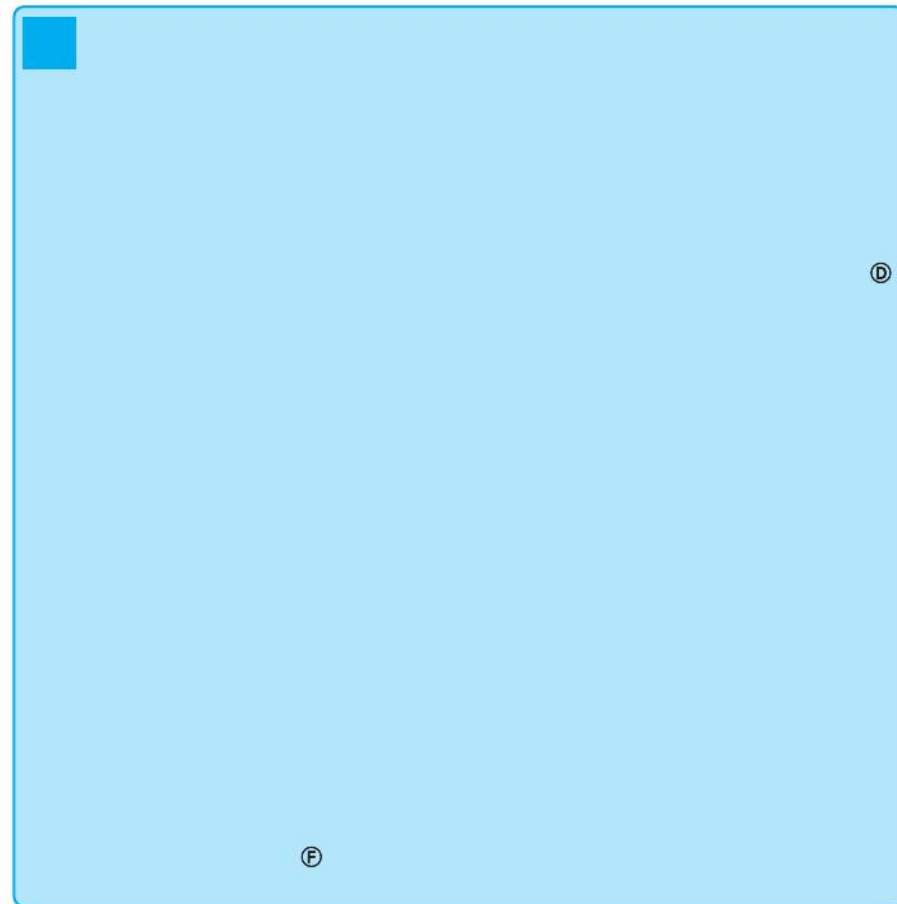
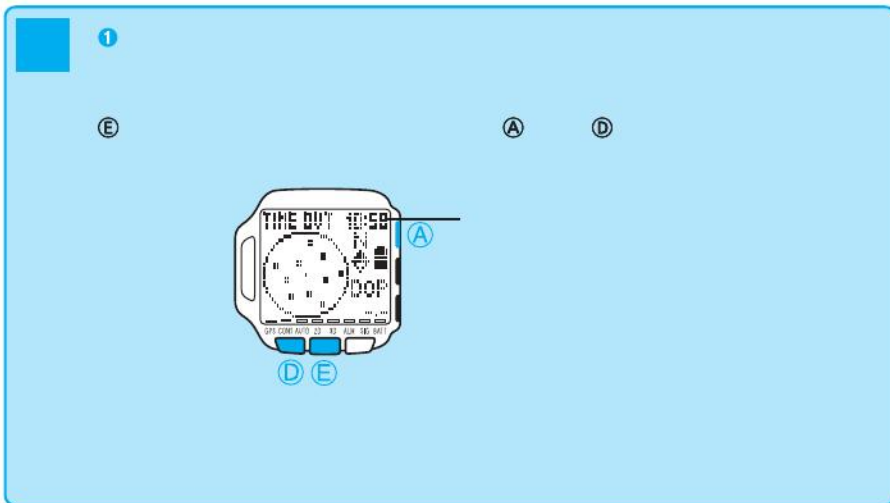

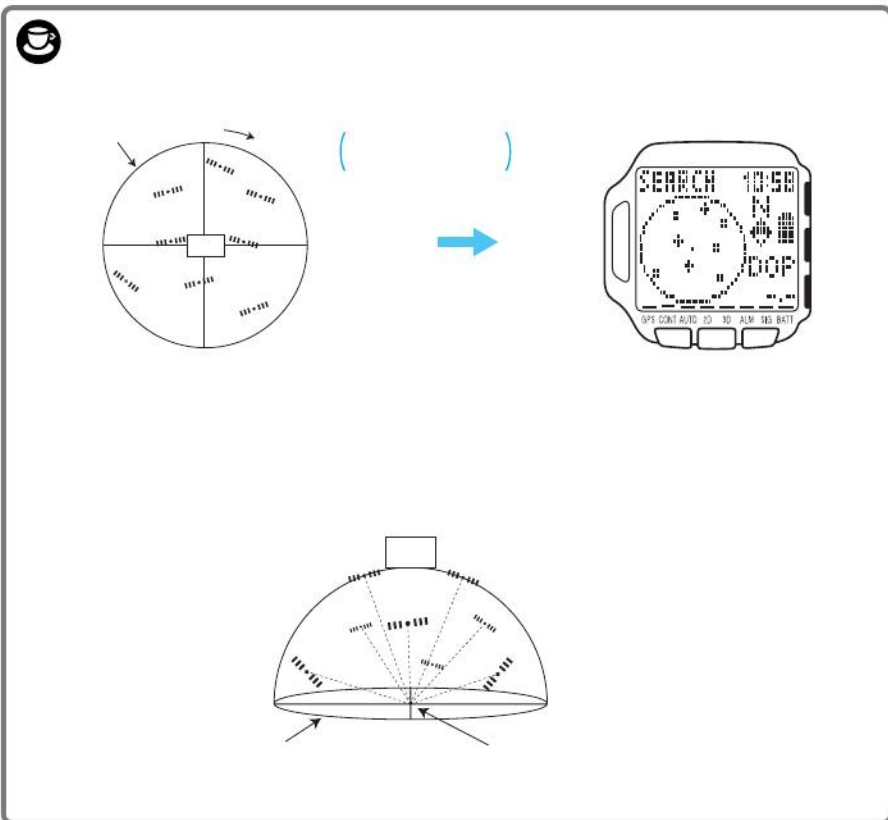





Ⓔ

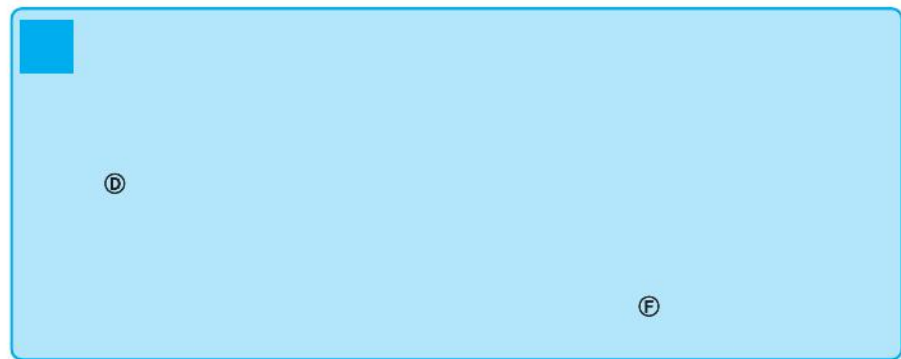

Ⓐ

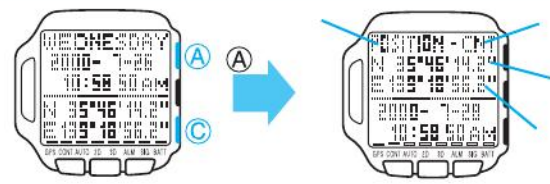

Ⓓ



Ⓓ

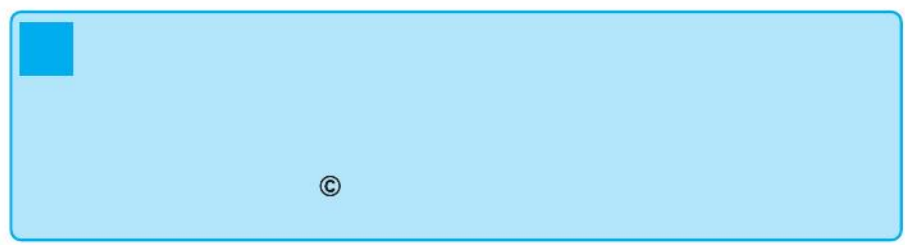
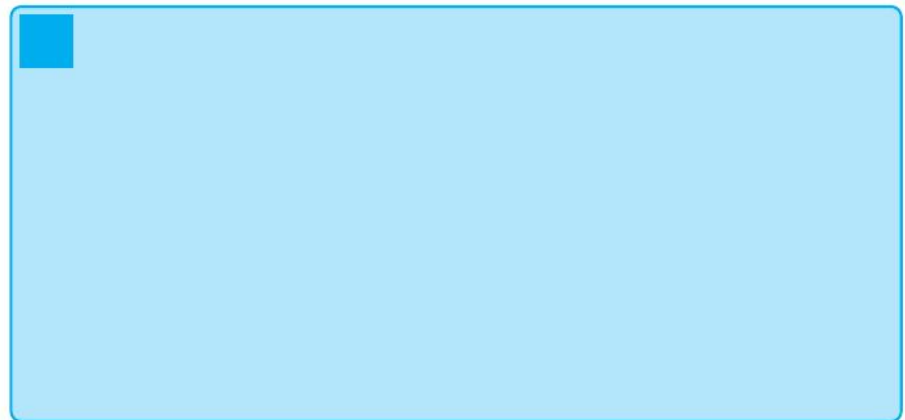

1

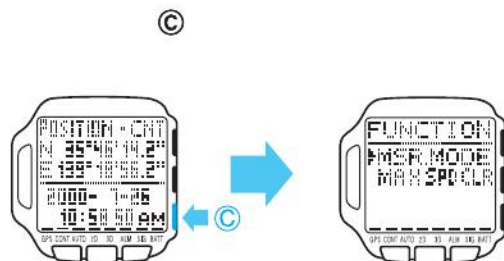

2

F

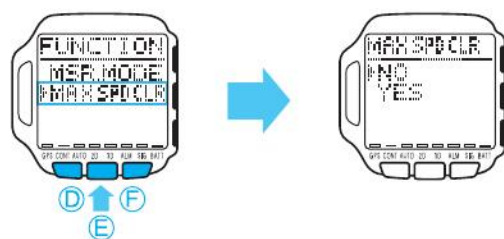

3

F

D

E

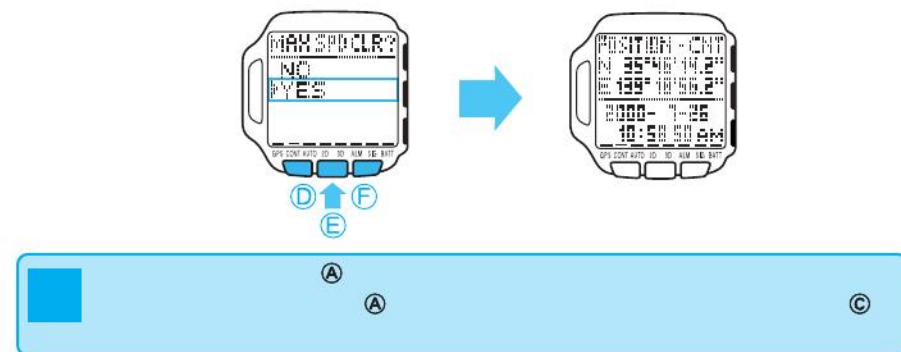



Ⓔ



Ⓐ



Ⓓ

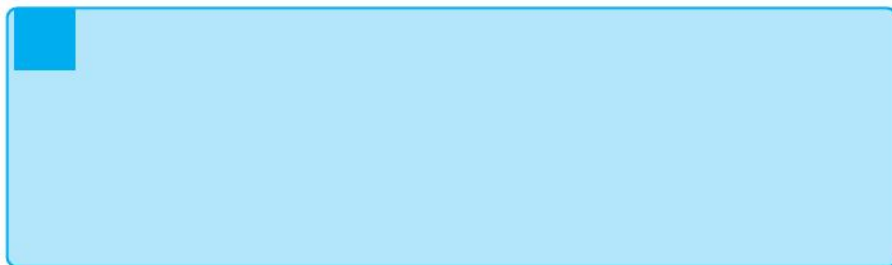

D

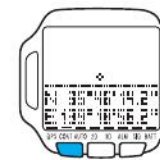

D

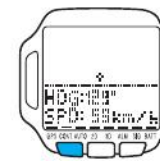

D



D



D

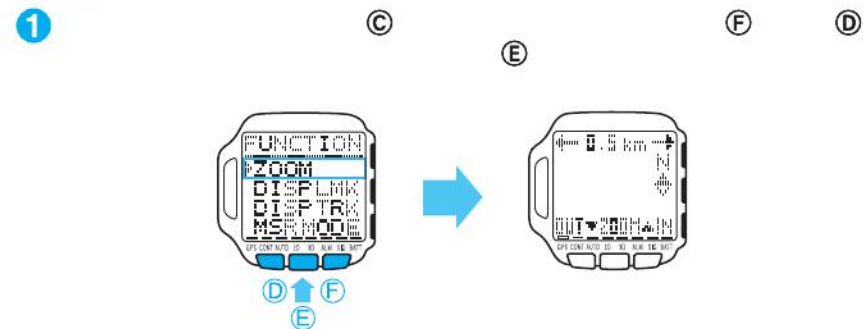
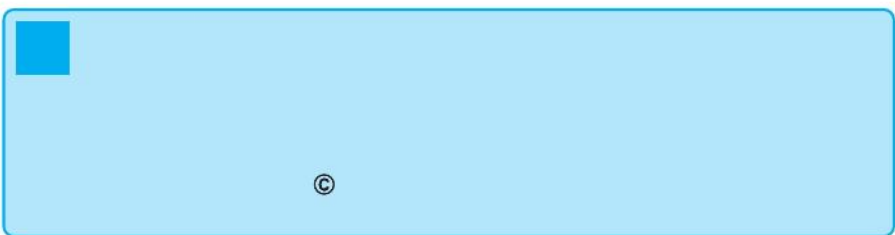
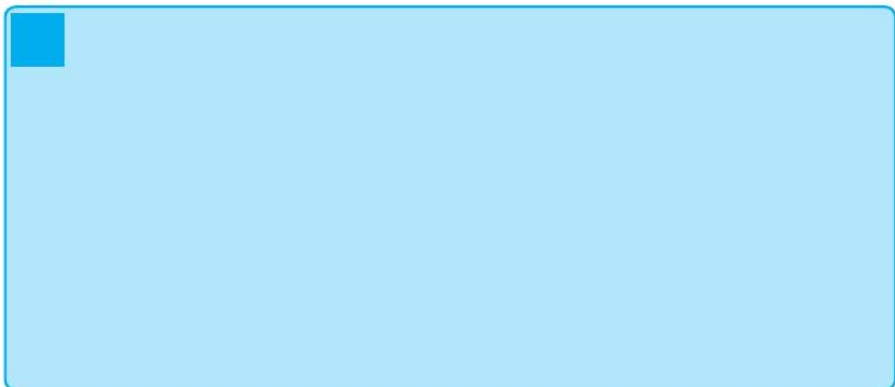

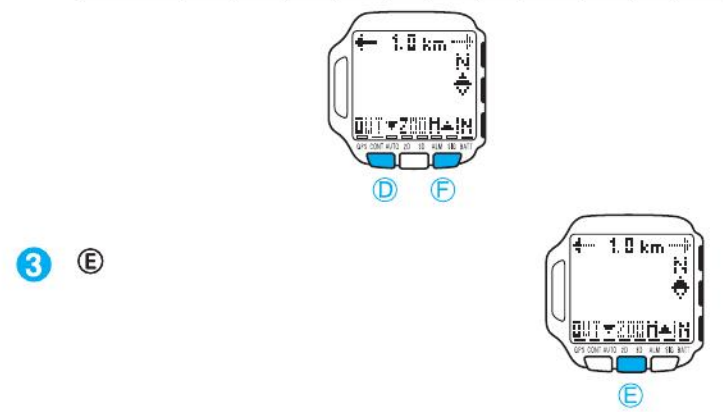



1 E F D

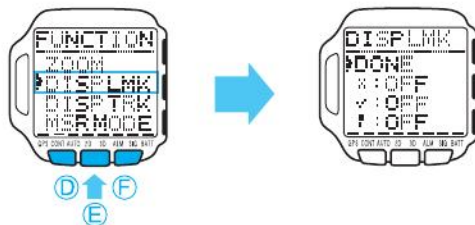

2 F E E D



3 F D E

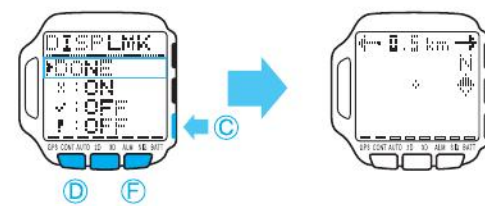

1 E F D

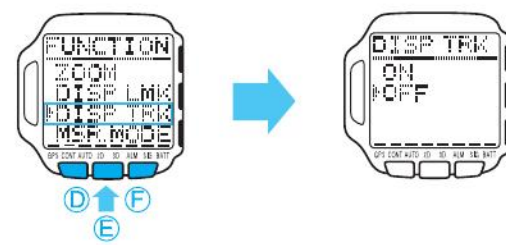



② F D E

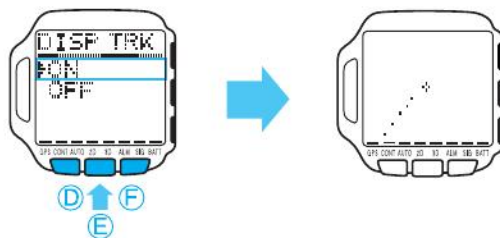



1

E F D

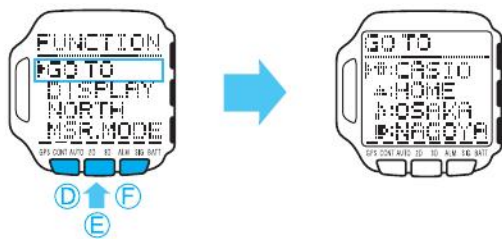

2

F D E

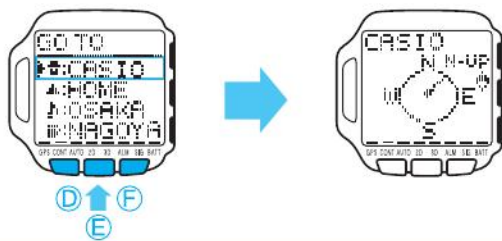

1

E F D

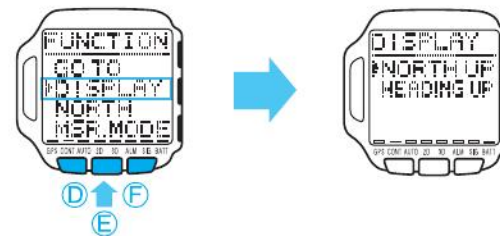

2

F D E

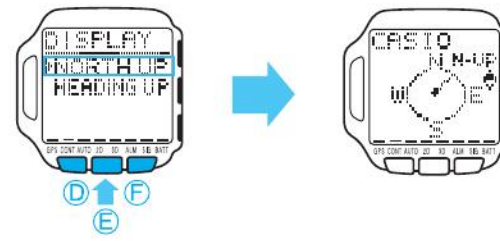

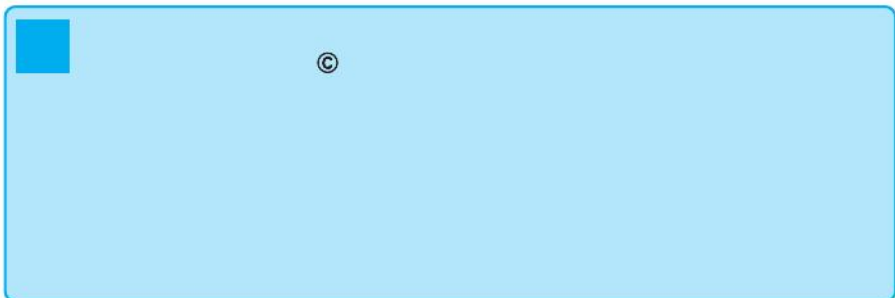

1



2

F

D

E



3

A

A



F

D

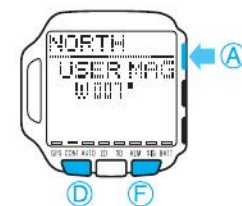

4 ④

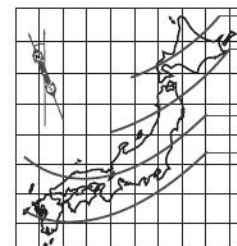
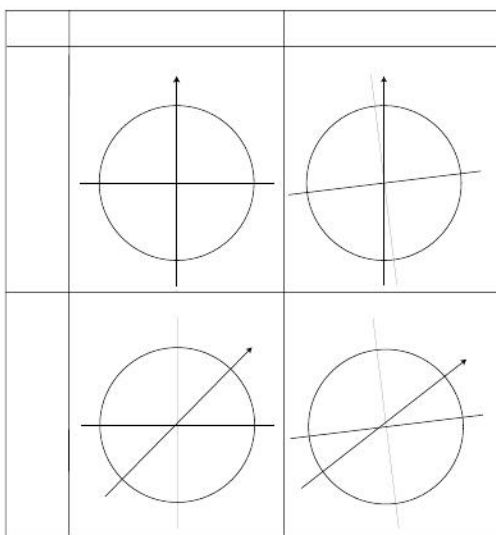
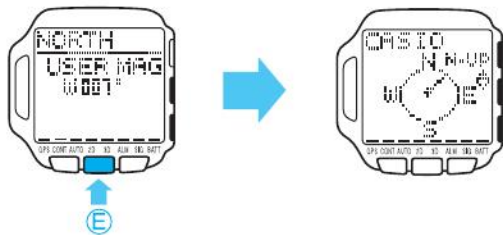

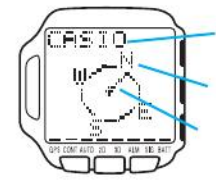
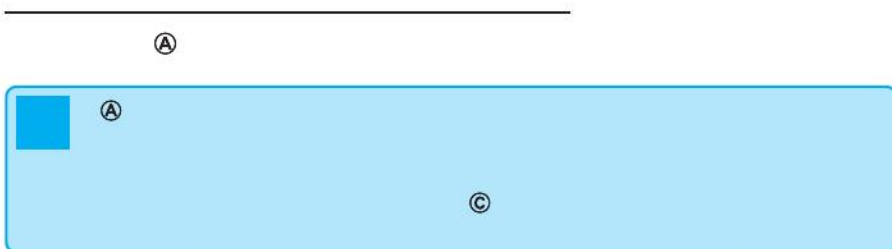

Ⓓ



1 C

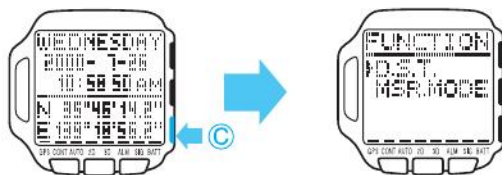

2 C

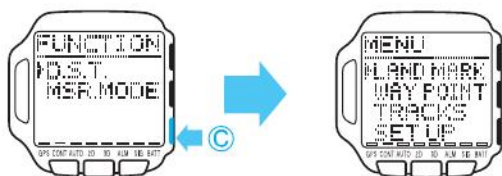

3 F D E

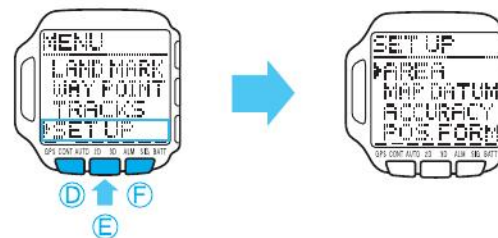

4 F D E

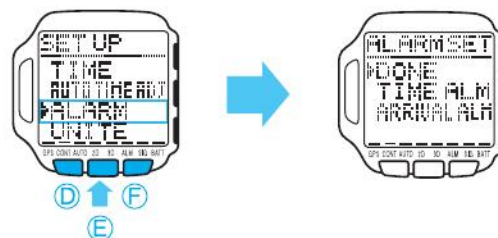

5 F D E

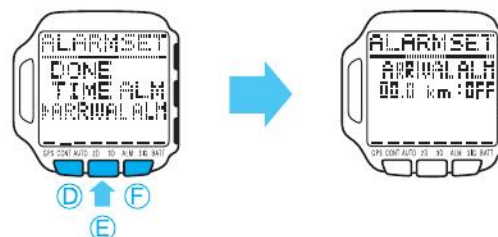

6

E

E

A

F



D



D ↑ F
E

7

F

D

E



D ↑ F
E

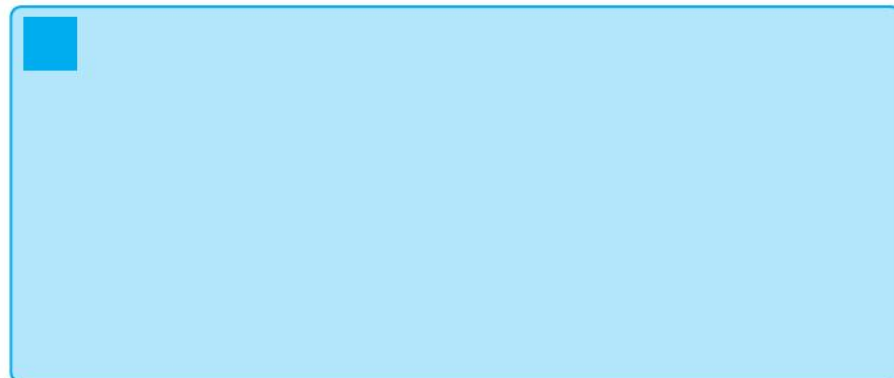

A C
A C

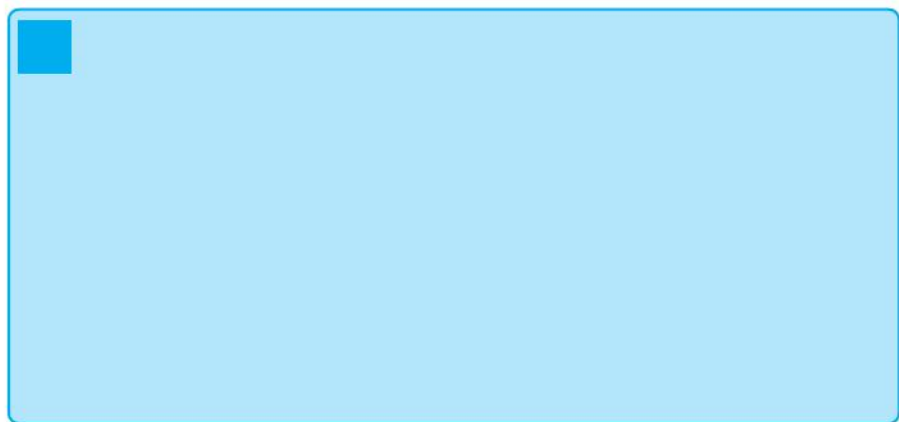

Ⓐ



Ⓐ

Ⓒ

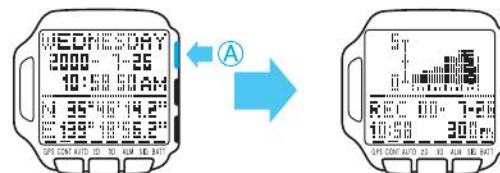

Ⓓ

Ⓔ







--	--	--	--	--	--





1

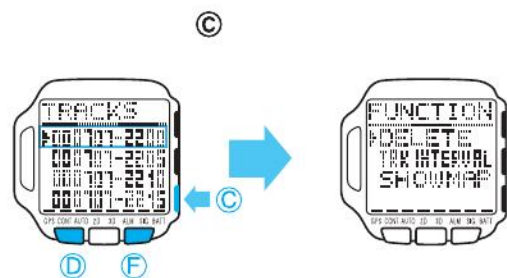

2

F

D

E

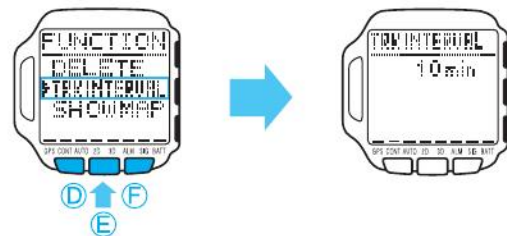

3

E

F D

F

D

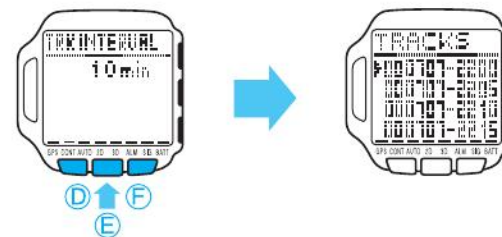



1

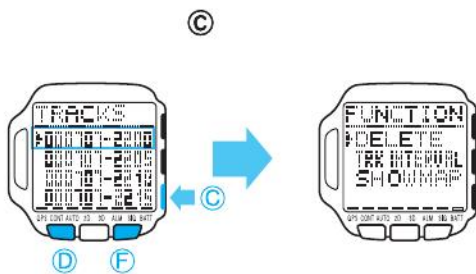

2

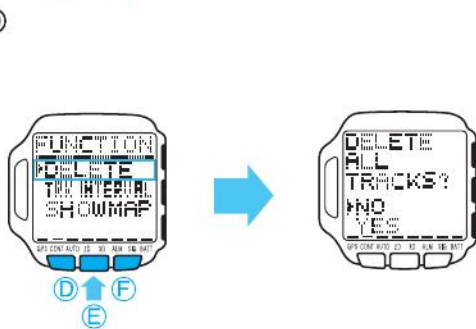

3

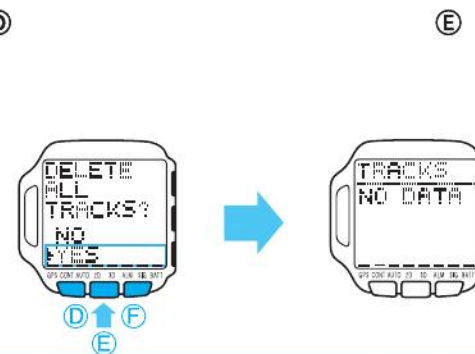

1

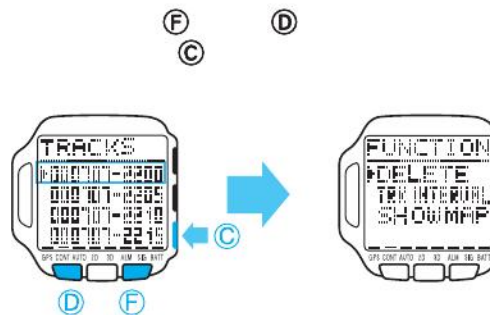

2

F

D

E

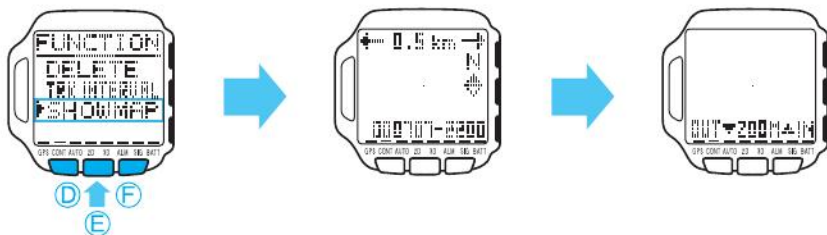

3

E

A

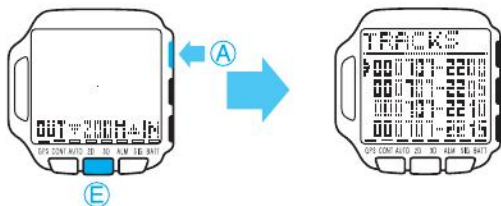

1

C

2

C

3

F

D

E

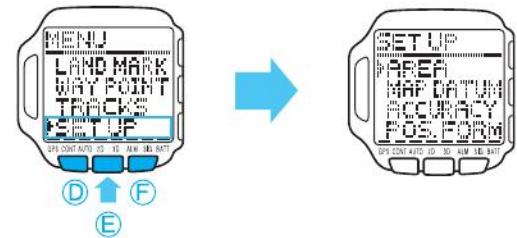
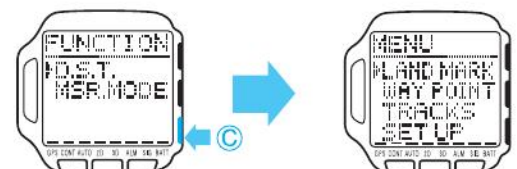
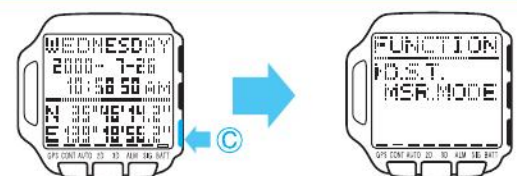

4 F D

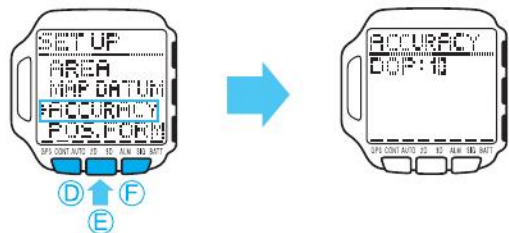

E

5

F

D



6

E

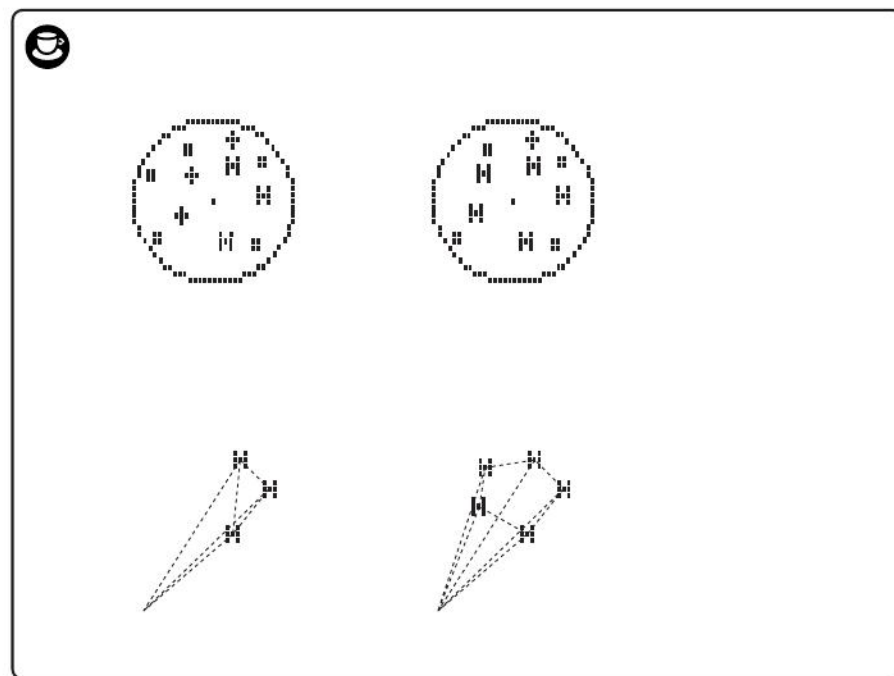
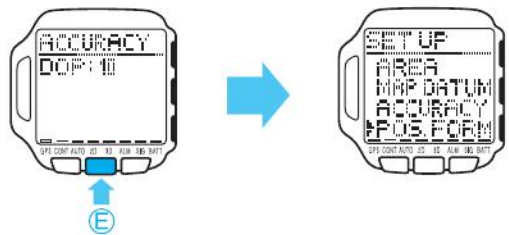

1

C

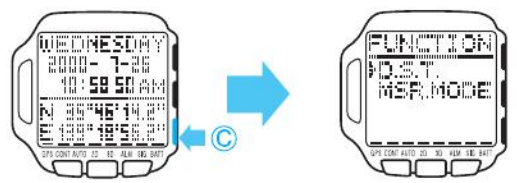

2

C

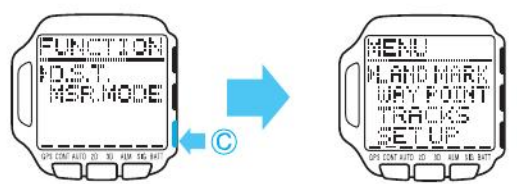

3

F

D

E

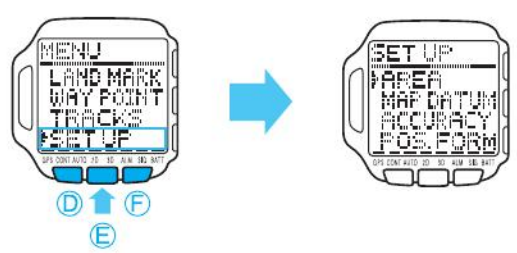

4

F

D

E

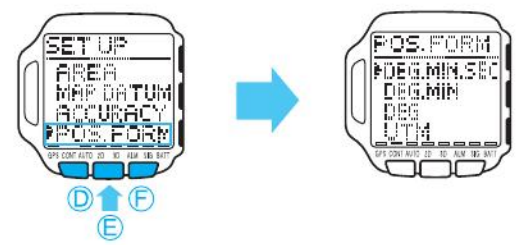

5

F

D

E

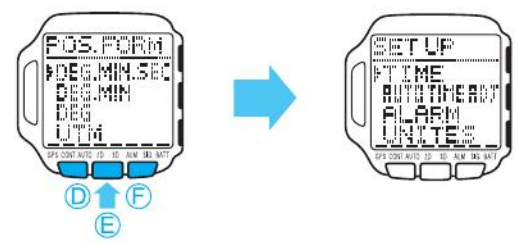

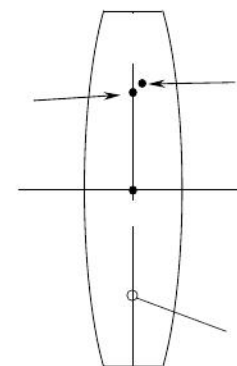
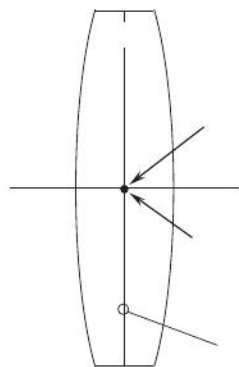

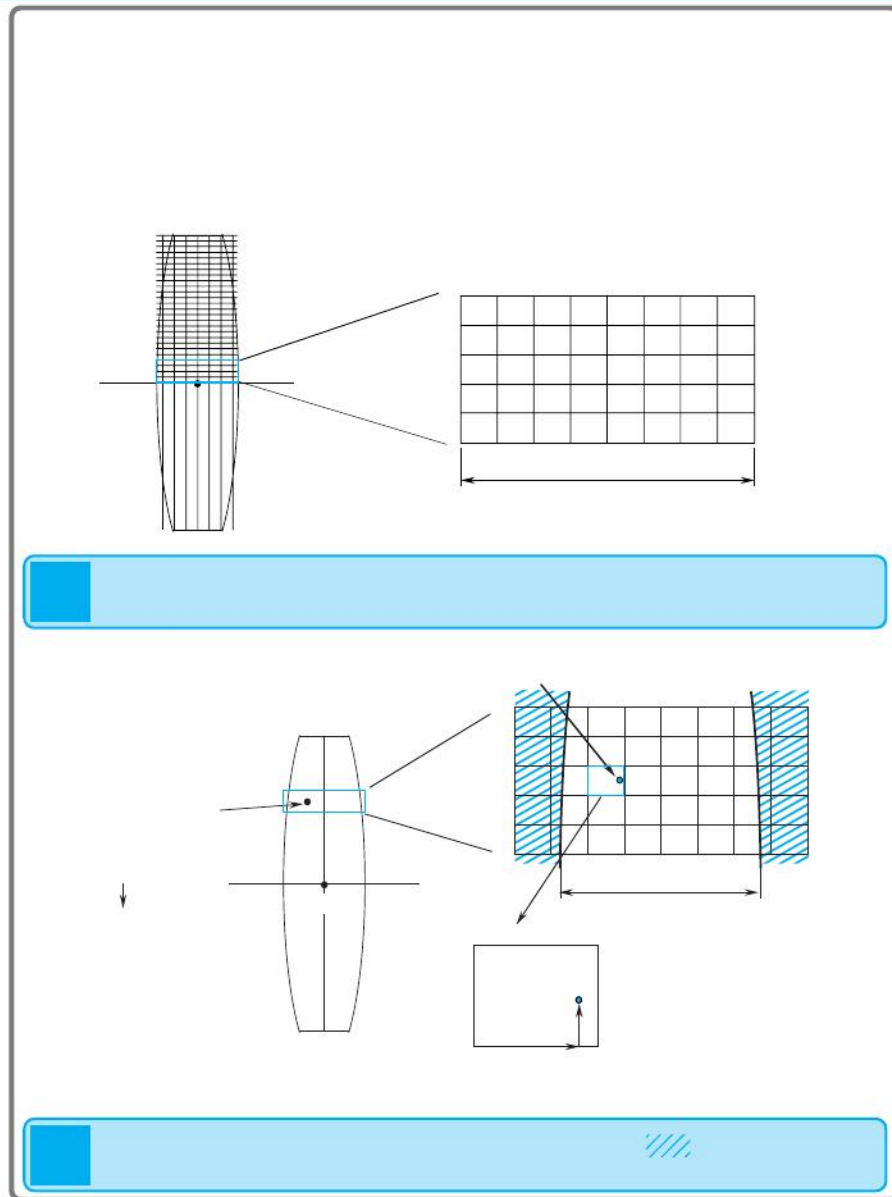
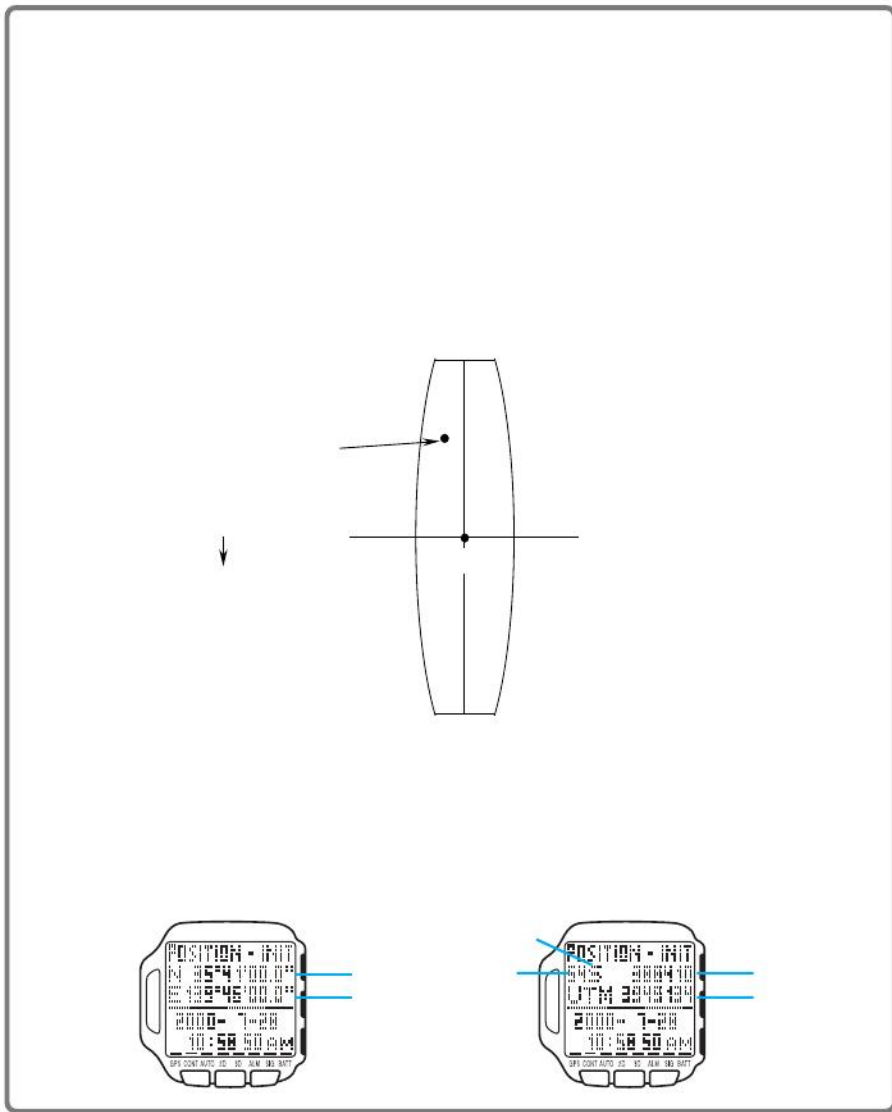

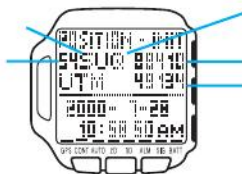

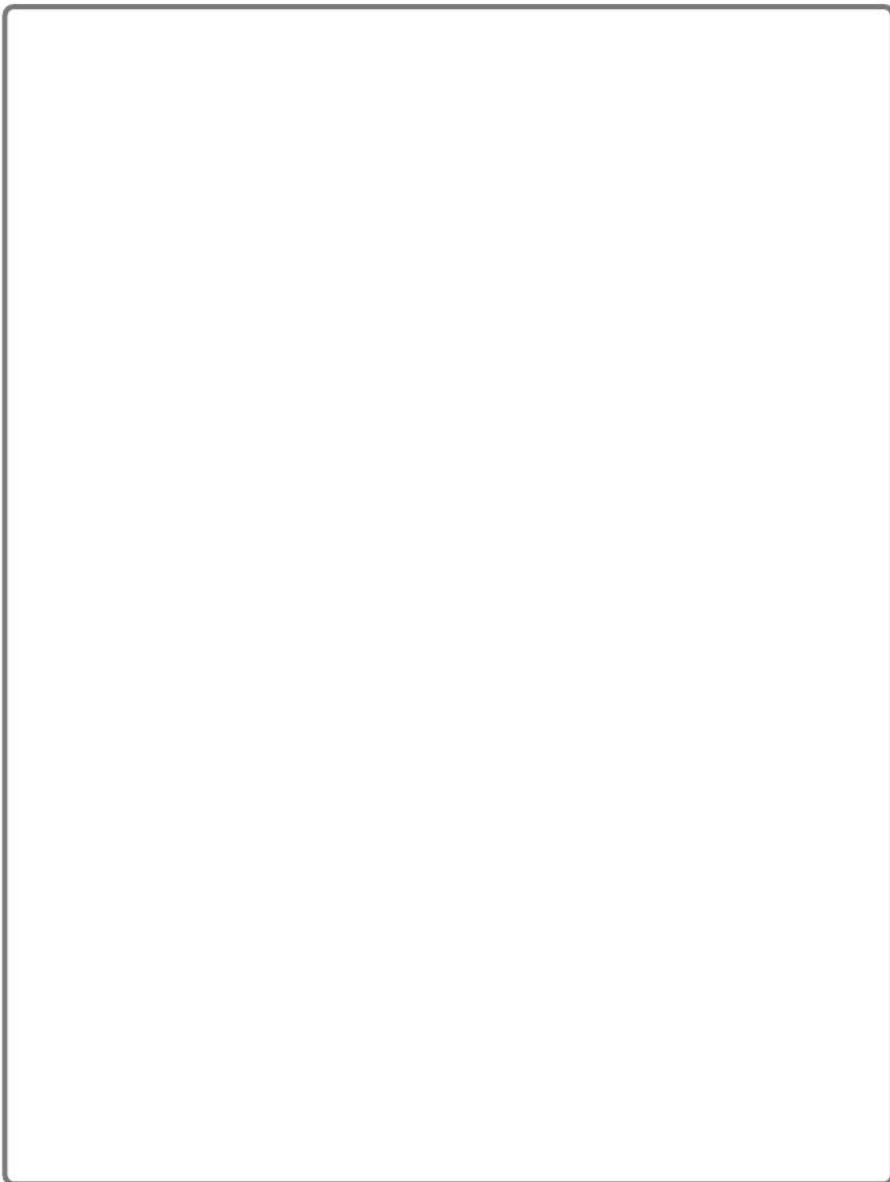

1

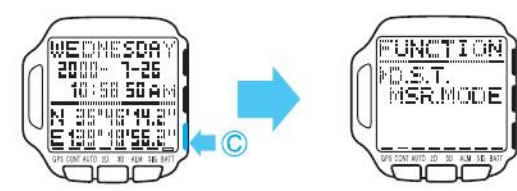

2

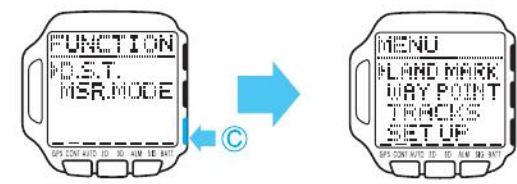

3

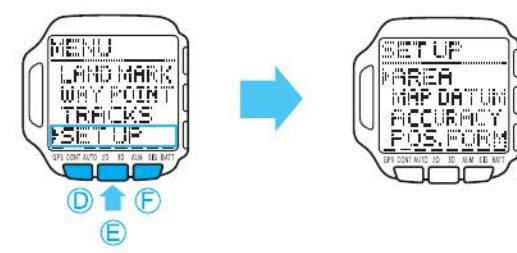

4 F D



E

D ↑ F
E

5 F D

E

F D

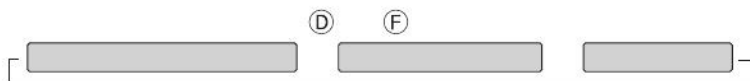

E



1

C



2

C



3

F

D

E



D ↑ F
E



4 F D

E

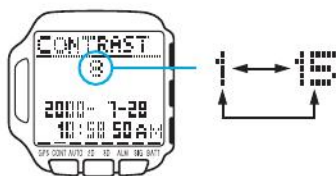

5 F D

E

F

D



5 C A



D



D

1

D

D

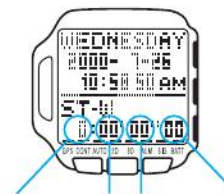

2

E F
E

F

F

F

F



E F

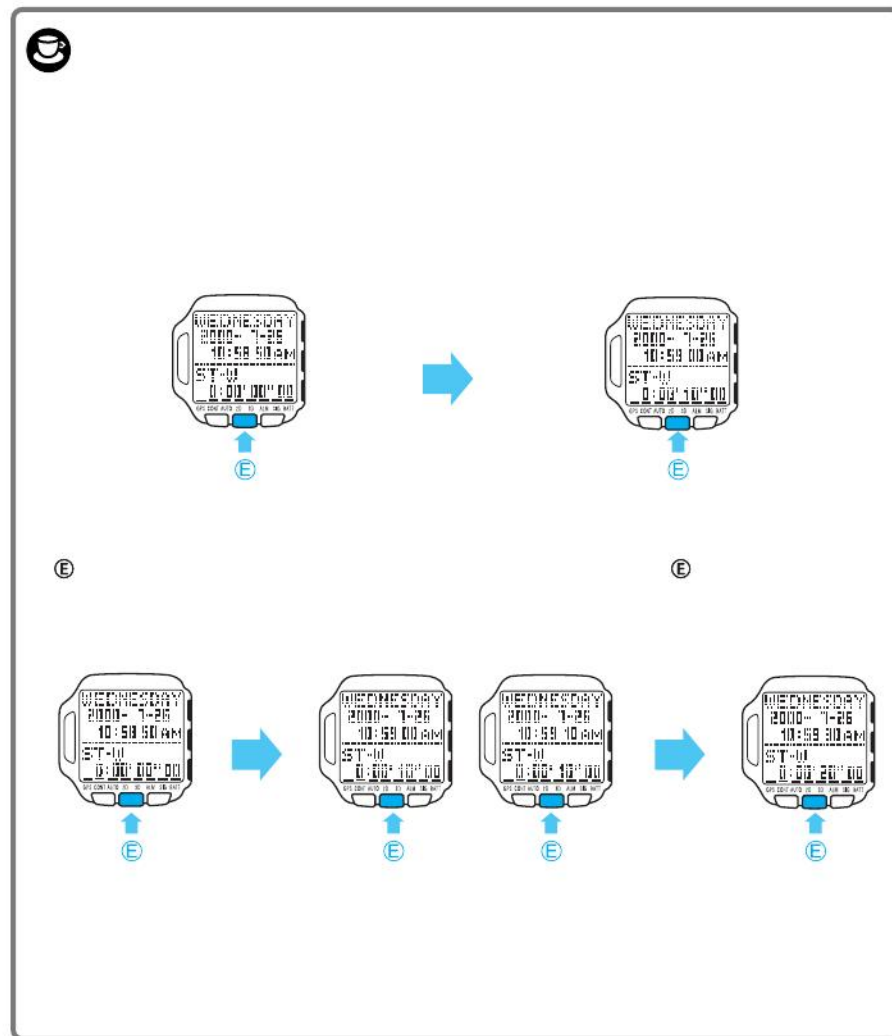
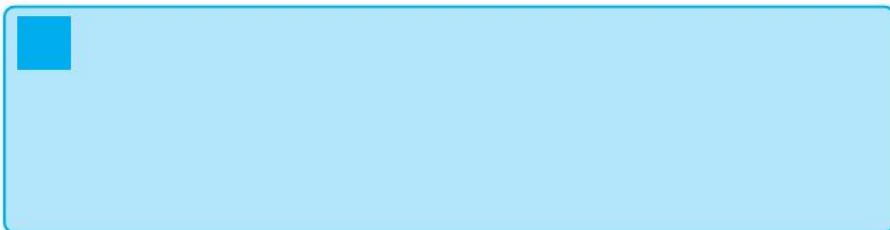

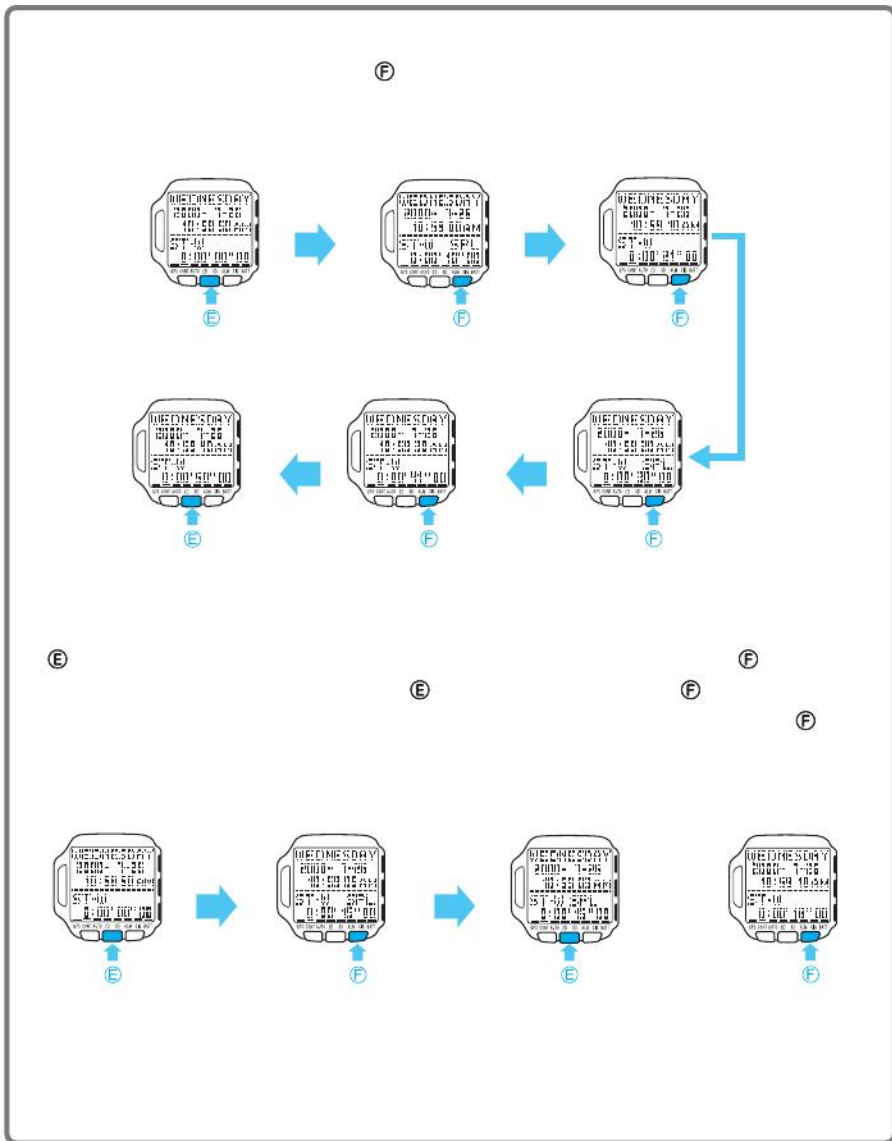

1

C



C

2

C

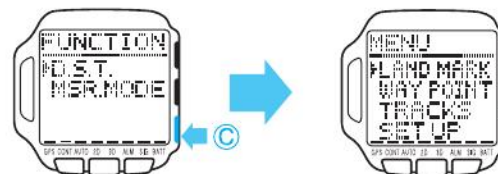
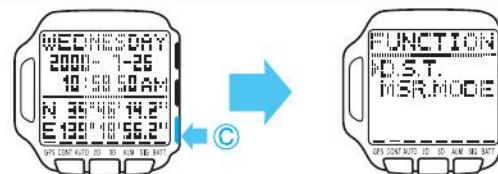

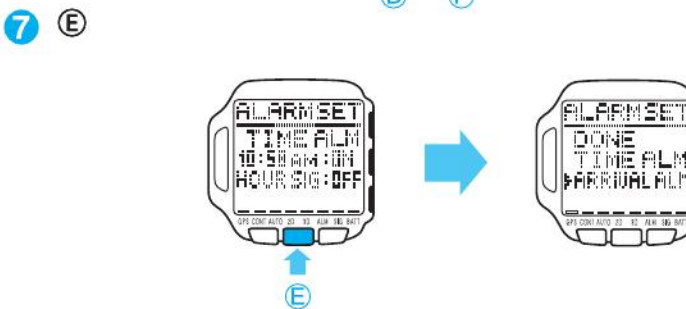
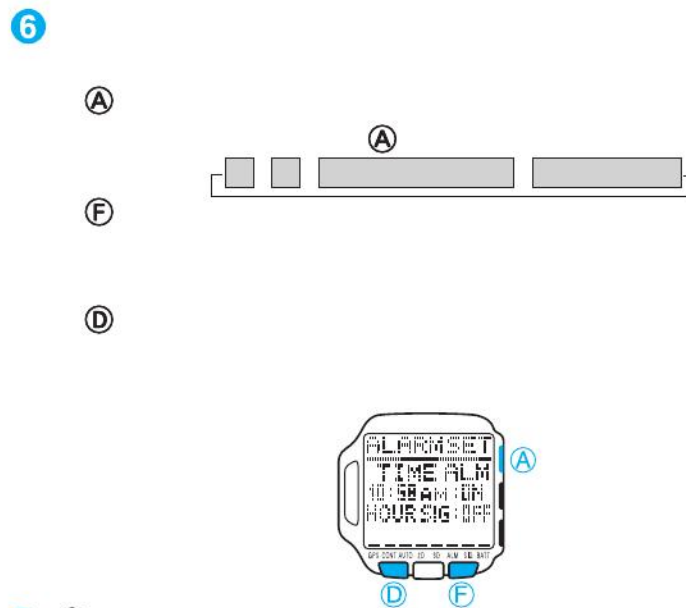
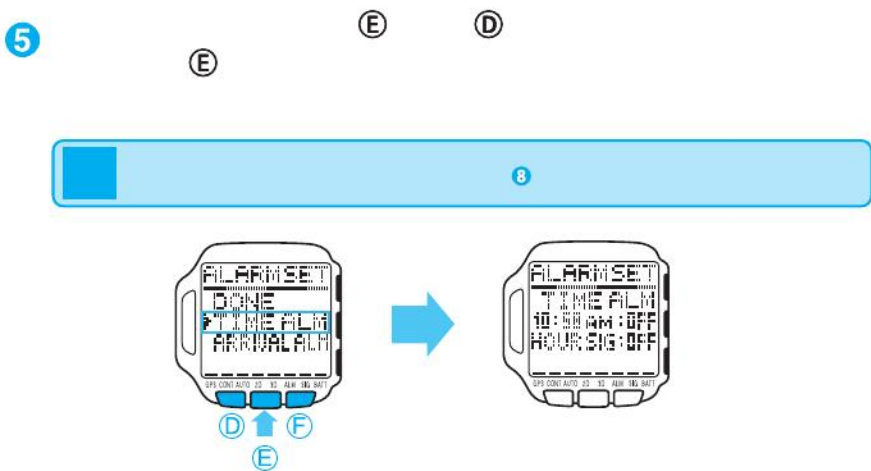
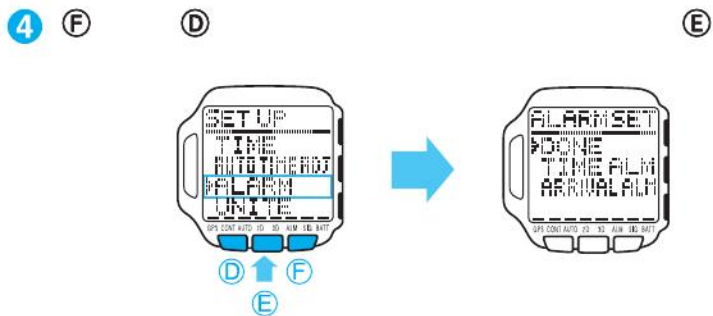
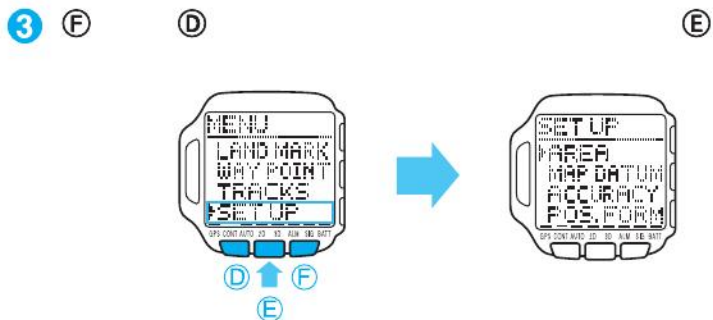

1

C

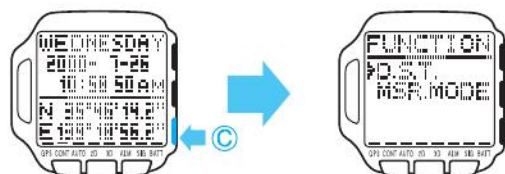

2

F

D

E

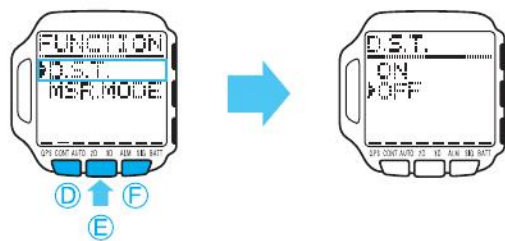

3

F

D

E

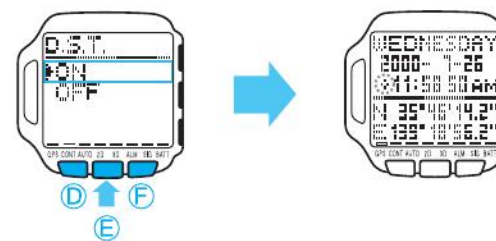

1

C

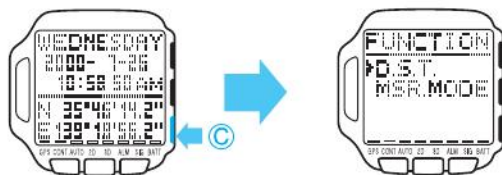

2

C

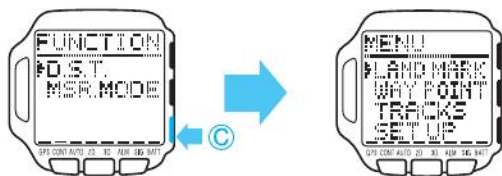

3

F

D

E

