

TECHNICAL INFORMATION

ManualsLib.com
CITIZEN QUARTZ

Cal. No. 6810✳

Cal. No. 6840✳



[Cal. No. 6810]



[Cal. No. 6840]

CONTENTS

1	OUTLINE	1
2	SPECIFICATIONS	
2-1	SPECIFICATIONS OF CAL 6810	2
2-2	SPECIFICATIONS OF CAL 6840	3
3	OPERATING METHOD	
3-1	OPERATING METHOD CAL 6810	4
3-2	OPERATING METHOD CAL 6840	14
4	FITTING PROCEDURE	32
5	POWER CELL REPLACEMENT PROCEDURE	35
6	PRECAUTIONS FOR DISASSEMBLING AND ASSEMBLING	39
7	DISASSEMBLY AND ASSEMBLY OF THE MODULE	41
8	INSPECTION AND ADJUSTMENT METHOD OF MODULE	43

1 OUTLINE

• CAL 6810

This watch is an analog multi-function quartz watch which has eight operation modes set with the push button.

Main functions

- Quick set alarm: A desired alarm time can be set easily from the present time. After alarm sound is finished, the setting of the alarm is automatically reset.
- Daily alarm: The alarm sounds at the same time every day.
- Snooze alarm: The alarm sounds at the set time and 3 and 6 minutes after the set time every day.
- Local time:
- Local time alarm:
- Calendar: Month and date (Correction is not necessary at each of month.)

• CAL 6840

This is an analog multi-function quartz watch having eight operation modes which can be changed with the push button.

Main functions

- Race 1 : 10-minute graphic timer
Auto-chronograph after time-up
repeated timer
- Race 2 : 1, 3 minute graphic timer
Auto-chronograph after time-up
- Race 3 : 3-, 5-, 10-, 15-minute graphic timer
- Timer : 90-minute timer
- Chronograph:
- Alarm:

2-1 SPECIFICATIONS OF CAL. 6810

Type	Analog quartz watch (Multi-hand)
Oscillation	32,768 Hz (Hz: Number of vibration in 1 second)
Accuracy	±20 sec/month at normal temperature (5°C ~ 35°C)
Effective temperature range	-10°C ~ +60°C (14°F ~ 140°F)
Converter	Bipolar step motor (3 units)
Integrated circuit	C-MOS-LSI (1 unit)
Adjustment of time rate	D.F.C. (Without adjustment terminal)
Functions	<ul style="list-style-type: none">● Hand-type calendar Month and date (No adjustment required at end of each month)● Alarm 1 <Quick-setting alarm> Setting range: Up to 23 hours 59 minutes at by 1 minute after the next 0 second.● Alarm 2 <Daily alarm>● Alarm 3 <Snooze alarm> Alarm sounds 3 times; at set time, 3 and 6 minutes after set time with different tones.● Local time Hour and minute set by 0 minute second can be adjusted.)● Local time alarm
Power cell	Small-sized silver battery. 1 unit. Binary No. 280-44 (SR927W)
Lifetime of power cell	Approx. 2 years Conditions: Alarms 1, 2, 3 and local time alarm are used once a day.

2-2 SPECIFICATIONS OF CAL. 6840

Type	Analog multi-hand quartz watch								
Oscillation	32,768 Hz (Hz: Frequency in 1 sec.)								
Accuracy	±20 seconds between 5°C ~ 35°C								
Effective temperature range	-10°C ~ +60°C (14°F ~ 140°F)								
Converters	Bipolar step motors (3 pcs)								
Integrated circuit	C-MOS-LSI (1 unit)								
Time adjustment	D.F.C. (No terminal)								
Functions	<p>Race 1: 10-minute graphic timer Auto-chronograph after time-up (90 minutes) Flyback Second hand reset</p> <p>Race 2: 10, 5-minute graphic timer Auto-chronograph after time-up (90 minutes) Flyback Second hand reset</p> <p>Race 3: 3, 5, 10, 15-minute graphic timer Flyback Second hand reset</p> <p>Timer: Flyback Chronograph: Manual reset in range: 30 minutes & 1/2 sec. Alarm: Daily alarm</p>								
Power cell	Small-sized silver battery: 1 pcs Power cell No.: 280-44 (SR927W)								
Life time of power cell	<p>Approx. 2 years</p> <p>Conditions:</p> <table> <tr> <td>1. Sound</td> <td>Daily alarm: once/day Timer: once/2 days Race 1, 2: once/week Race 3: once/day</td> </tr> <tr> <td>2. Graphic timer</td> <td>Race 1, 2: once/week Race 3: once/day</td> </tr> <tr> <td>3. Timer</td> <td>once/day for 30 minutes</td> </tr> <tr> <td>4. Chronograph</td> <td>once/day for 30 minutes</td> </tr> </table>	1. Sound	Daily alarm: once/day Timer: once/2 days Race 1, 2: once/week Race 3: once/day	2. Graphic timer	Race 1, 2: once/week Race 3: once/day	3. Timer	once/day for 30 minutes	4. Chronograph	once/day for 30 minutes
1. Sound	Daily alarm: once/day Timer: once/2 days Race 1, 2: once/week Race 3: once/day								
2. Graphic timer	Race 1, 2: once/week Race 3: once/day								
3. Timer	once/day for 30 minutes								
4. Chronograph	once/day for 30 minutes								

3-1 OPERATING METHOD CAL 6810

§1 MAIN COMPONENTS

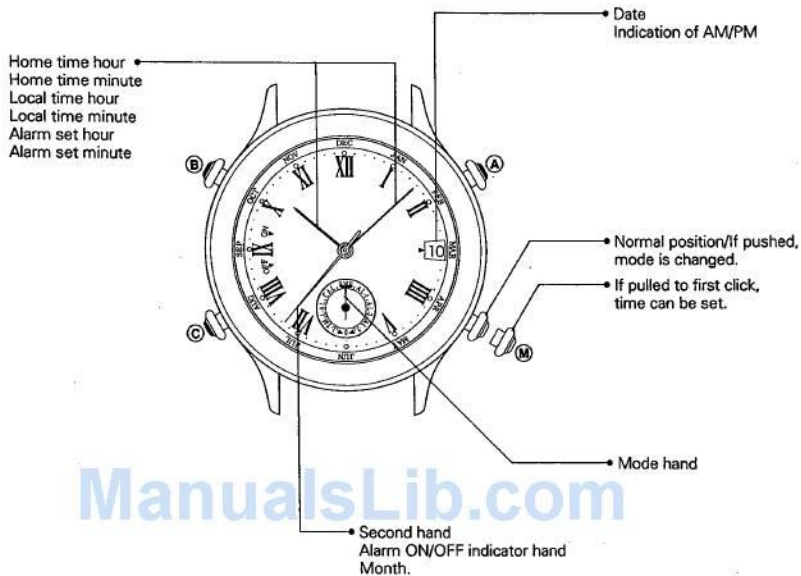

§2 MODE CHANGE-OVER

If the (M) button is pushed from its normal position, the mode is changed in the following order.

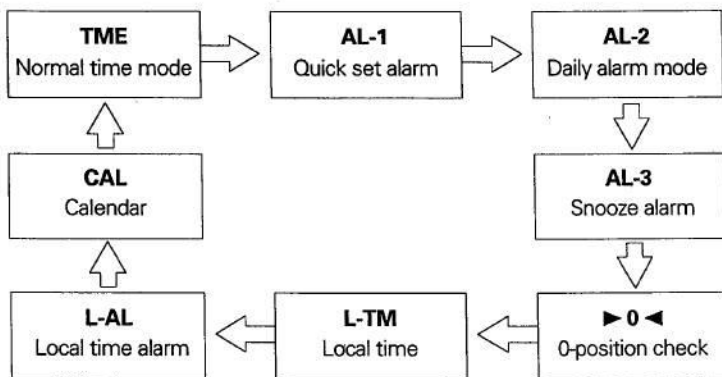

Note:

The mode button can be pushed by accident. Check it occasionally and correct if necessary.

§3 BEFORE USE

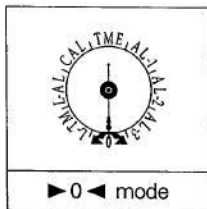

Before using this watch, be sure to confirm by the following method in the ▶ 0 ◀ mode that each function works normally.

- 1) If the zero adjustment has been performed correctly, the hour, minute and second hands are set to the following positions.

Hour hand: 12 o'clock

Minute hand: 0 minute

Second hand: 0 second

Window : ▶ ◀ 0

If any hand is not set as shown above, perform the zero adjustment.

Notes:

If any one of the (A), (B) and (C) buttons is pushed while the (M) button is in the normal position, the hour, minute and second hands move to right and left and the date hand moves up and down for demonstration.

ZERO POSITION SETTING

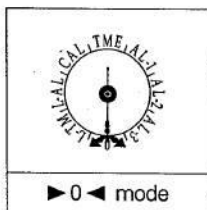

- 1) Pull the (M) button to the first click.

Push the (A) button to set the second hand to 0 second (top of dial).

Push the (B) button to set the ▶ mark on the dial to the ◀ 0 mark in the window.

Push the (C) button to set the hour and minute hands to 12 o'clock and 0 minute (top of dial).

- 2) Securely push the (M) button to the normal position.

The zero adjustment is finished by this operation.

▶ ◀ 0

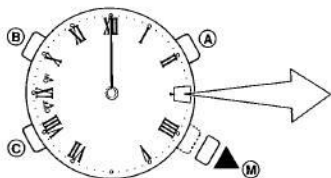

Notes:

1. The zero position may shift if a strong shock is given to the watch.
2. If the (A), (B) or (C) button is pushed and held, the related hand moves fast.
3. Check the zero position occasionally.

54 HOW TO SET AND OPERATE EACH MODE

1. SETTING THE TIME

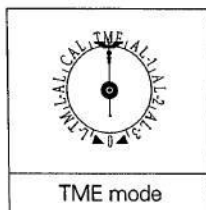

Pull the **(M)** button to the first click in the time mode to set the time.

Roles of hands and setting method of them

	(M) button at normal position	(M) button at first click (Setting position)	Setting
Hour hand	Home time hour	Home time hour	(B) button Hour/minute hand clockwise adjustment (C) button Hour/minute hand counterclockwise adjustment
Minute hand	Home time minute	Home time minute	
Second hand	Second	Second	Return second hand to 0 with (A) button.
Window	Date	AM/PM indication	Automatically set when hour and minute are set (Cannot be set by itself).

Notes:

- Return to 0:
When the **(A)** button is pushed, if the second hand is at 0–29 seconds, the minute hand is not changed, and if the former is at 30 – 59 seconds, the latter is advanced by 1 minute.
- If the **(B)** or **(C)** button is pushed and held, the related hand moves fast.
- After the time is set, return the **(M)** button to its normal position.

2. SETTING QUICK SET ALARM

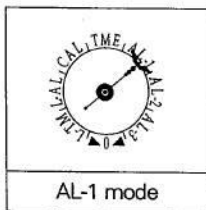

While the alarm is turned off, the hour, minute and second hands are set to the present time. Accordingly, they can be easily set to a desired alarm time.

If the alarm finishes sounding once, the alarm setting is automatically reset and all the hands return to the present time (The alarm sounds for 10 seconds).

When setting the alarm, the **(M)** button does not need to be pulled to the first click.

Roles of hands and setting method of them

	(M) button at normal position	Setting
Hour hand	Alarm set hour	(B) button Hour/minute hand clockwise adjustment (C) button Hour/minute hand counterclockwise adjustment
Minute hand	Alarm set minute	
Second hand	Alarm ON/OFF indication	Sound monitor (5 sec)/Alarm cancel with (A) button.
Window	AM/PM indication	Automatically set when hour and minute are set (Cannot be set by itself).

Notes:

If the **(B)** or **(C)** button is pushed and held, the related hand moves fast.

Quick set alarm ON/OFF indication

Alarm cancel/Sound monitor

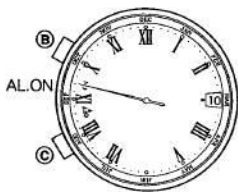

If the **(A)** button is pushed while the second hand is indicating AL.ON, the alarm is canceled.

If the **(A)** button is pushed while the second hand is indicating the normal time (alarm is turned off), alarm sound can be confirmed. The sound monitor continues for 5 seconds.

If the alarm is set with the **(B)** and **(C)** buttons, the second hand indicates AL.ON.

If the alarm is turned off, the second hand indicate the normal time

3. SETTING THE DAILY ALARM

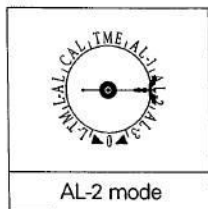

If the alarm time is set once, the watch sounds at the same time every day (for 15 seconds) like an alarm clock.

When setting the daily alarm, pull the (M) button to the first click.

Roles of hands and setting method of them

	(M) button at normal position	(M) button at first click (Setting position)	Setting
Hour hand	Alarm set hour	Alarm set hour	(B) button Hour/minute hand clockwise adjustment (C) button Hour/minute hand counterclockwise adjustment
Minute hand	Alarm set minute	Alarm set minute	
Second hand	Alarm ON/OFF indicator	Auto alarm ON (OFF → ON) (ON → OFF)	Turn on/off alarm with (A) button.
Window	AM/PM indication	AM/PM indication	Automatically set when hour and minute are set (Cannot be set by itself).

Notes:

1. If the (B) or (C) button is pushed and held, the related hand moves fast.
2. After the time is set, return the (M) button to its normal position.

Daily alarm ON/OFF indication

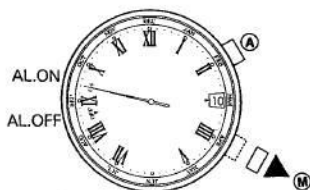

If the (M) button is pulled to the first click while the second hand is indicating AL.OFF, the alarm is turned on automatically (Auto Alarm ON).

Every time the (A) button is pushed after the (M) button is pulled out, the alarm is turned on and off.

Stopping of sound monitor/daily alarm

If the (A) button is pushed with the (M) button at the normal position, regardless of the state of the alarm, alarm sound can be checked. The sound monitor continues for 5 seconds.

If any one of the (A), (B) and (C) buttons is pushed while the daily alarm is sounding, the alarm stops sounding.

5. SETTING THE TIME

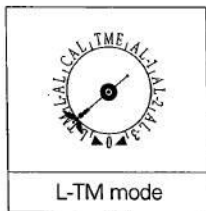

When taking a trip abroad, the local time of this watch is set to the time in each place, that is, this watch can be used as dualtime watch.

Set the time in the local time mode with the **(M)** button pulled to the first click.

Roles of hands and setting method of them

	(M) button at normal position	(M) button at first click (Setting position)	Setting
Hour hand	Home time hour	Local time hour	(B) button Hour/minute hand clockwise adjustment (C) button Hour/minute hand counterclockwise adjustment
Minute hand	Local time minute	Local time minute	
Second hand	Second	Second	Cannot be corrected.
Window	AM/PM indication	AM/PM indication	Automatically set when hour and minute are set (Cannot be set by itself).

Notes:

1. The hour and minute hands are interlocked and can be set by the unit of 30 minutes. The second hand cannot be corrected in the local time mode.
2. If the **(B)** or **(C)** button is pushed and held, the related hand moves fast.
3. After the time is set, return the **(M)** button to its normal position.

4. SETTING THE SNOOZE ALARM

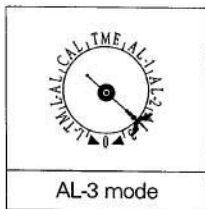

The alarm sounds once at the alarm set time and two more times at the interval of 3 minutes, that is, three times in total. Sounding continues for 15 second each time.

When setting the daily alarm, pull the **(M)** button to the first click.

Roles of hands and setting method of them

	(M) button at normal position	(M) button at first click (Setting position)	Setting
Hour hand	Alarm set hour	Alarm set hour	(B) button Hour/minute hand clockwise adjustment (C) button Hour/minute hand counterclockwise adjustment
Minute hand	Alarm set minute	Alarm set minute	
Second hand	Alarm ON/OFF indication	Auto Alarm ON (OFF → ON) (ON → ON)	Turn on or off with (A) button.
Window	AM/PM indication	AM/PM indication	Automatically set when hour and minute are set (Cannot be set by itself).

Notes:

1. If the **(B)** or **(C)** button is pushed and held, the related hand moves fast.
2. After the time is set, return the **(M)** button to its normal position.

Snooze alarm ON/OFF indication

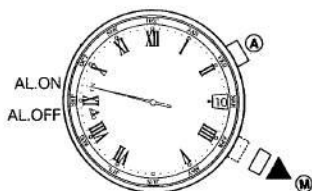

If the **(M)** button is pulled to the first click while the second hand is indicating AL.OFF, the alarm is turned on automatically (Auto Alarm ON).

Every time the **(A)** button is pushed after the **(M)** button is pulled out, the alarm is turned on and off.

Stopping of sound monitor/daily alarm

If the **(A)** button is pushed with the **(M)** button at the normal position, regardless of the state of the alarm, alarm sound can be checked. The sound monitor continues for 6 seconds.

If any one of the **(A)**, **(B)** and **(C)** buttons is pushed for 3 seconds while the snooze alarm is sounding, the alarm (including the snooze alarms 3 and 6 minutes later) stops sounding.

Note:

If the button is released in 3 seconds, the alarm does not stop sounding.

7. SETTING THE CALENDAR

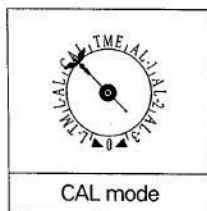

The calendar of this watch does not need to be corrected at the end of each month.

For example, this watch indicates the next day of June 30 as July 01.

Since this watch cannot indicate February 29, however, correct it in each leap year (February 29).

Roles of hands and setting method of them

	Ⓜ button at normal position	Ⓜ button at first click (Setting position)	Setting
Hour hand	Home time hour	Home time hour	Cannot be corrected.
Minute hand	Home time minute	Home time minute	
Second hand	Month	Month	Set month with ⓐ button.
Window	Date	Date	ⓑ button Hour/minute hand clockwise adjustment ⓒ button Hour/minute hand counterclockwise adjustment

Notes:

- Automatic non-existing date correcting function:
If the calendar is set to a non-existing date and the Ⓜ button is returned to the normal position, the calendar is automatically set to the first day of the next month.
Example: September 31 → October 01
- If the ⓐ, ⓑ or ⓒ button is pushed and held, the related hand moves fast.
- After the time is set, return the Ⓜ button to its normal position.

6. SETTING THE LOCAL TIME ALARM

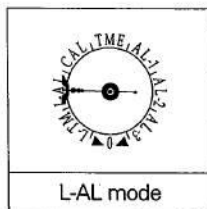

If the alarm time is set once, the watch sounds at the same local time every day (for 15 seconds) like an alarm clock.

When setting the daily alarm, pull the **(M)** button to the first click.

Roles of hands and setting method of them

	(M) button at normal position	(M) button at first click (Setting position)	Setting
Hour hand	Alarm set hour	Alarm set hour	(B) button Hour/minute hand clockwise adjustment (C) button Hour/minute hand counterclockwise adjustment
Minute hand	Alarm set minute	Alarm set minute	
Second hand	Alarm ON/OFF indication	Auto Alarm ON (OFF → ON) (ON → ON)	Turn on or off with (A) button.
Window	AM/PM indication	AM/PM indication	Automatically set when hour and minute are set (Cannot be set by itself).

Notes:

1. If the **(B)** or **(C)** button is pushed and held, the related hand moves fast.
2. After the time is set, return the **(M)** button to its normal position.

Local time alarm ON/OFF indication

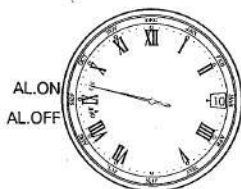

Stopping of sound monitor/local time alarm

If the **(A)** button is pushed with the **(M)** button at the normal position, regardless of the state of the alarm, alarm sound can be checked. *The sound monitor continues for 5 seconds.*

If any one of the **(A)**, **(B)** and **(C)** buttons is pushed while the daily alarm is sounding, *the alarm stops sounding.*

If the **(M)** button is pulled to the first click while the second hand is indicating AL.OFF, the alarm is turned on automatically (*Auto Alarm ON*).

Every time the **(A)** button is pushed after the **(M)** button is pulled out, *the alarm is turned on and off.*

3-2 OPERATING METHOD CAL 6840

§1 MAIN COMPONENTS

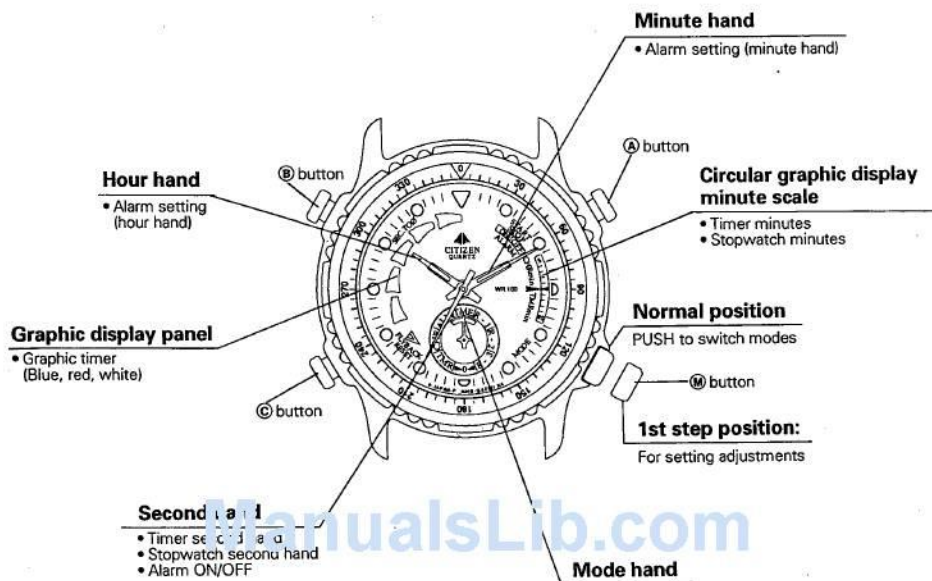

§2 MODE CHANGE-OVER

Push the **M** button in the normal position to switch between modes as shown below.

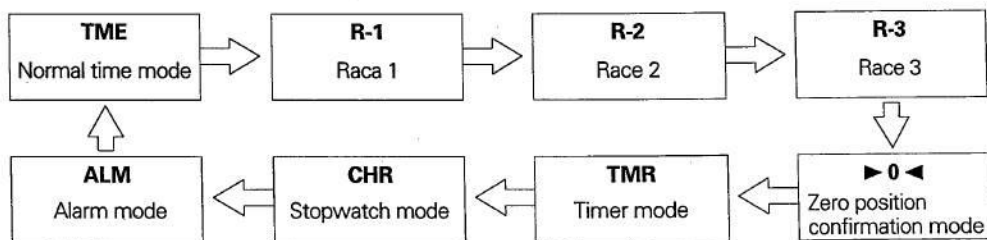

Note:

Be sure to check the mode hand to ensure that the watch is set in the desired mode for use. Pressing the **M** button accidentally during operation may occur.

8. MONITOR FUNCTION

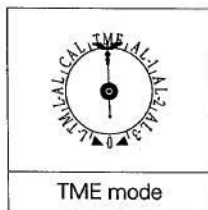

Daily alarm monitor (AL-2)

If the **(B)** button is pushed in the TME mode, the set time of the daily alarm can be checked (for 10 seconds).

If any one of the **(A)**, **(B)** and **(C)** buttons is pushed, the *monitor function is reset*.

Even if a button is not pushed, the watch *automatically returns to the normal mode* after 10 seconds.

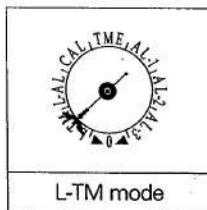

Local time alarm monitor (L-AL)

If the **(B)** button is pushed in the local time mode, the set time of the local time alarm can be checked (for 10 seconds).

If any one of the **(A)**, **(B)** and **(C)** buttons is pushed, the *monitor function is reset*.

Even if a button is not pushed, the watch *automatically returns to the normal mode* after 10 seconds.

ManualsLib.com

ALL RESET

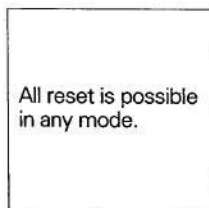

Perform the all reset operation after the battery is replaced or the watch operates abnormally.

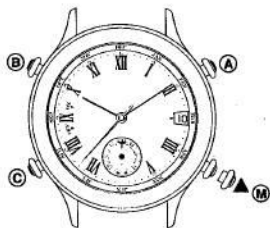

- 1) Pull the **(M)** button to the first click.
- 2) Securely push the **(A)**, **(B)** and **(C)** buttons at the same time for 2 seconds or more.

If all the buttons are released, the hour, minute and second hands and date dial move for demonstration and the confirmation sound comes out.

After the above operation is confirmed, return the **(M)** button to the normal position.

Then, perform the zero adjustment in the zero-position check mode (**(▶ 0 ◀)** mode). (See the section of the zero adjustment.)

§4 HOW TO SET AND OPERATE EACH MODE

1. SETTING THE TIME

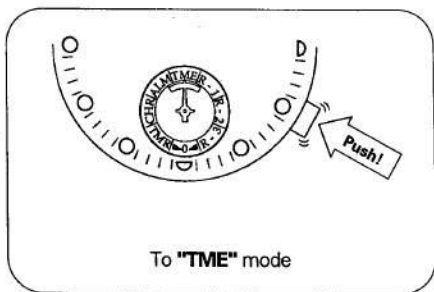

Setting procedures

- 1) Pull the **(M)** button out to the 1st step position.

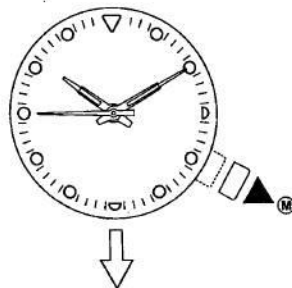

- 2) Press the **(A)** button to use the second hand reset function.

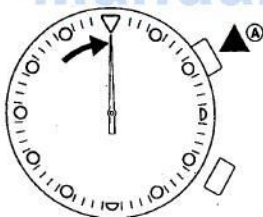

- Pressing the **(A)** button while the second hand is in the **0-29 sec. position** will not alter the minute hand position.
- Pressing the **(A)** button while the second hand is in the **30-59 sec. position** will advance the minute hand to the next full minute position.

- 3) Press the **(B)** button to move the hour/minute hands clockwise.

- Press the **(C)** button to move the hour/minute hands **counterclockwise**.

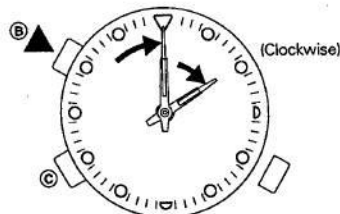

- Press and hold down the **(B)** or **(C)** button to use the quick-advance feature.

§3 BEFORE USE

Before use, follow the procedure below to ensure that all watch components are in proper working order.

Zero position confirmation check.

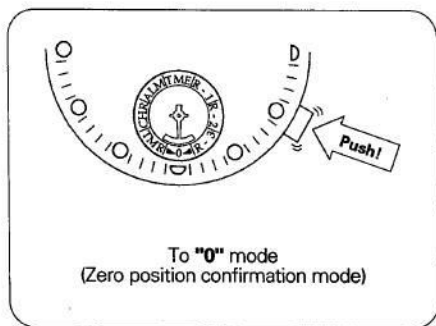

- 1) Each hand positioned as listed below. Confirm and correct if necessary.

Hour hand 12 o'clock.

Minute hand 0 min.

Second hand 0 sec.

Circular graphic display
minute scale



- 2) If the watch hands are not positioned as above, follow the Zero position setting procedures to ensure proper use.

☆ Push the (A), (B) or (C) button, with the (M) button in the normal position, to activate the circular graphic display minute scale, hand movement check.

ZERO POSITION SETTING

(in the Zero position confirmation mode)

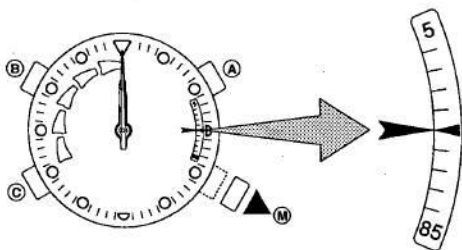

- 1) Pull the (M) button out to the 1st step position.

Reset the Watch. See pg 29.

Push the (A) button to move the second hand to 0 sec. position.

Push the (B) button to align the arrows on the minutes scale and dial.

Push the (C) button to move the hour/minute hands to the 12 O'clock/0 min. position.

- 2) Push the (M) button in to the normal position to **complete setting procedures.**

☆ **Any strong shock to the watch may cause the hands to shift from the Zero position. In this case, reset to the correct Zero position.**

☆ Press and hold down either of the (A), (B), (C) buttons for the quick-advance feature.

☆ Check from time to time to see whether the hands are in the correct Zero position.

☆ Slight irregular movement may occur when setting the second hand Zero position. This movement has no adverse effect on any of the watch functions.

(2) Timer repeat function General recall* — R-1 mode only

- **The stopwatch starts automatically after timer operation is completed.**

Pressing the C button for more than 1 second in the stopwatch mode will restart the 10-minute timer with the graphic timer displayed. **Fig. 1**

- **Timer repeat function** is convenient for use at the start of a (yacht) race.

* **General Recall** — Flying start at the beginning of a yacht race.

Fig. 1

The example below shows the start of the timer repeat function after the 10-minute timer has completed operation and the stopwatch has run for 3 minutes.

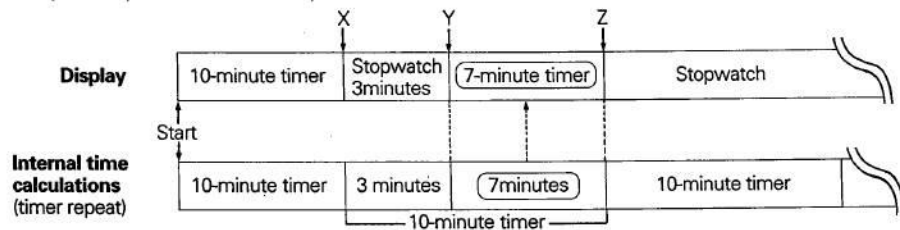

X → The stopwatch starts automatically after timer operation is completed. Stopwatch operation continues for 3 minutes.

Y → Pressing the © button for more than 1 second will automatically start the timer for the time remaining on the 10-minute timer and display the results graphically. Time remaining is automatically calculated by unit conversions (stopwatch operation in a continuously running internal 10-minute timer. (in this example, $10-3=7$ minutes of time remaining.)

Z → The stopwatch starts automatically at zero after timer operation is completed.

(3) Second hand reset (R-1, R-2, R-3)

- Press and hold down the ⊕ button for more than 1 second when using the graphic timer to reset the second hand.

When the second hand is between:

59~50 sec. position — The second hand quick-advances clockwise to zero, the elapsed time display remains the same and the countdown restarts.

49~1 sec. position — The second hand quick-advances counterclockwise to zero, 1 minute is subtracted from the elapsed time display and the countdown restarts.

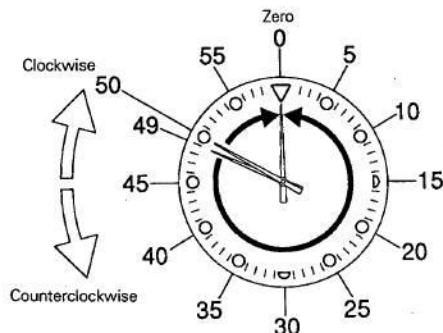

(4) Flyback feature — timer restart — (R-1, 4-2, 4-3)

- **To automatically restart the timer from the beginning**, press and hold down the © button for more than 1 second while the timer is running.

(5) TimeUp confirmation beep (R-1, R-2, R-3)

- A confirmation beep sounds during timer operation at:
 - 5~1 minutes (1-minute intervals)
 - 50~10 seconds (10-second intervals)
 - 9~1 seconds (1-second intervals)

2. USING RACE MODE 1

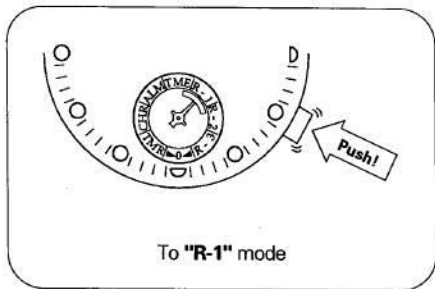

Race mode 1

- R-1 timer (1)
- Timer repeat function (2)
- Second hand reset function (3)
- Flyback feature (4)
- TimeUp confirmation beep (5)

Reading the graphic display panel

10-minute timer

- Standby mode
- All windows are **BLUE**:



- after 5 minutes
- All windows are **RED**:

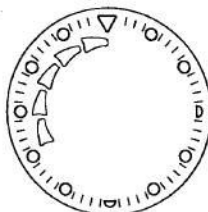

- TimeUp
- All windows are **WHITE**:

Race mode 1 Features

(1) R-1 timer

— 10-minute timer —

Graphic timer display (R-1, R-2, R-3)

- The stopwatch starts automatically after timer operation is completed.
- **See** Using the R-1 timer, pg 19.
- Time remaining during timer countdown is displayed with the second hand and the color (blue red white) graphic display panel.

Graphic timer display

Second hand seconds

Graphic display panel minutes

- ☆ The timer countdown hand (second hand) moves counterclockwise subtracting time from the timer setting.
- ☆ The graphic display panel moves clockwise.

Reading the graphic timer display

Ex. 1



9 min. 39 sec. remaining

Ex. 2



6 min. remaining

Ex. 3

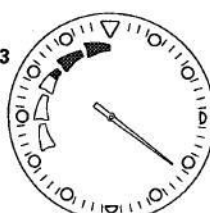

2 min. 21sec. remaining

3. USING RACE MODE 2

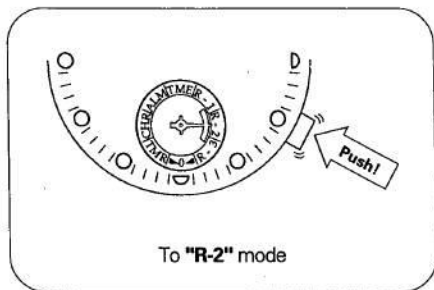

Race mode 2

- R-2 timer (1)
- Second hand reset function (2)
- Flyback feature (3)
- TimeUp confirmation beep (4)

Race mode 2 Features

(1) R-2 timer

- **The stopwatch starts automatically after timer (10-minute) operation is completed. Press and hold down the © button for more than 1 second while stopwatch is running to move to the 5-minute timer standby mode. See pg 21~22.**
- Time remaining during timer countdown is displayed on the graphic display panel.
- ☆ The timer countdown hand (second hand) moves counterclockwise subtracting time from the timer setting.

(2) Second hand reset function

(3) Flyback —

(4) TimeUp confirmation beep

- (2), (3), (4) are the same as in Race mode 1. See pg 18

Using the R-1 timer

Timer standby mode

 :BLUE

 : Press and hold down for more than 1 second

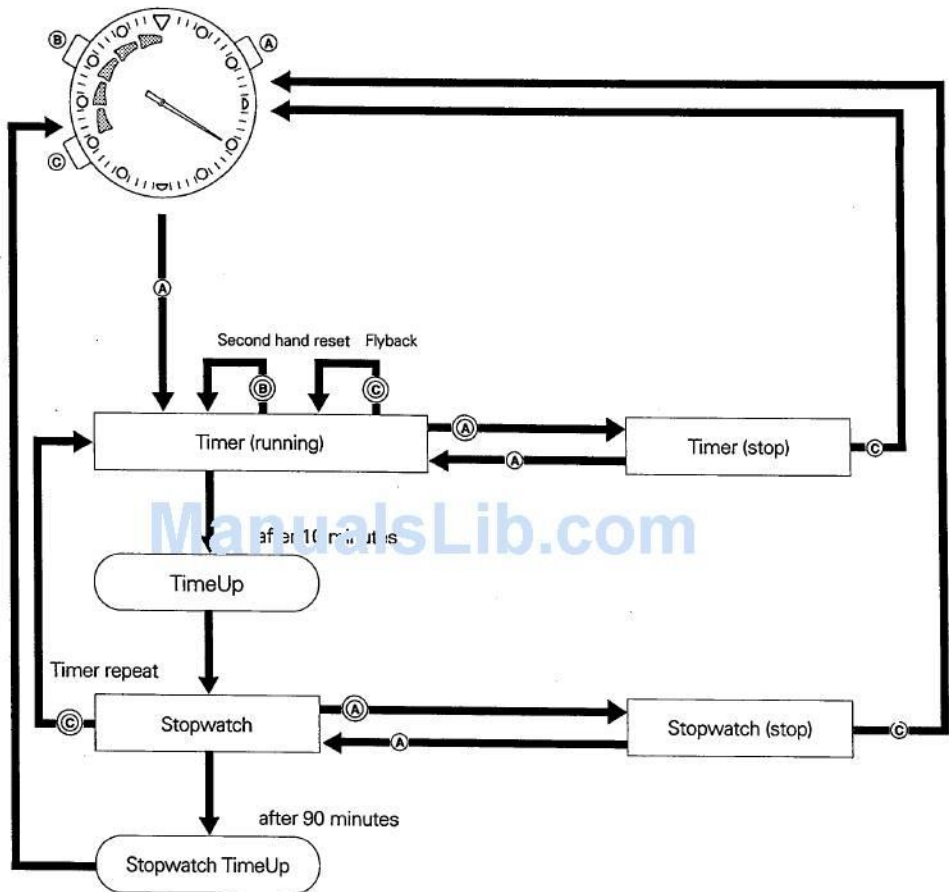

☆ Elapsed time display changes as watch switches from timer to stopwatch:

Stopwatch minutes — read off the circular graphic display minute scale

Stopwatch seconds — read off the second hand

☆ In timer standby mode, the current time is displayed.

☆ When the timer is running, the hour/minute hands display the current time; the second hand displays the timer countdown in seconds.

☆ Once the timer is started, it will compensate for time lost while the graphic display panel moves into the correct position. Elapsed time data is accurately displayed on the graphic display panel.

5-minute timer

Timer standby mode

▶ :RED

Ⓞ : Press and hold down for more than 1 second

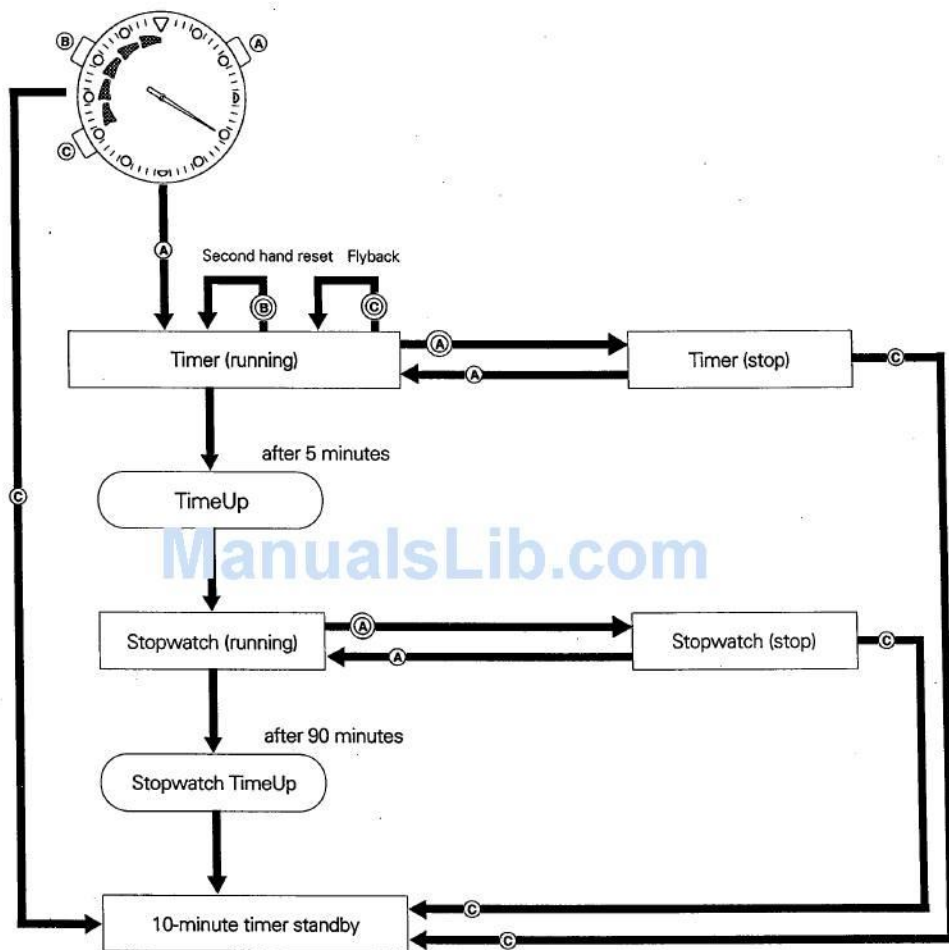

☆ Elapsed time display changes as watch switches from timer to stopwatch:

Stopwatch minutes — read off the circular graphic display minute scale

Stopwatch seconds — read off the second hand

☆ In timer standby mode, the current time is displayed.

☆ When the timer is running, the hour/minute hands display the current time; the second hand displays the timer countdown in seconds.

☆ Once the timer is started, it will compensate for time lost while the graphic display panel moves into the correct position. Elapsed time data is accurately displayed on the graphic display panel.

Using the R-2 timer 10-minute timer

Timer standby mode

▶:BLUE

ⓐ: Press and hold down for more than 1 second

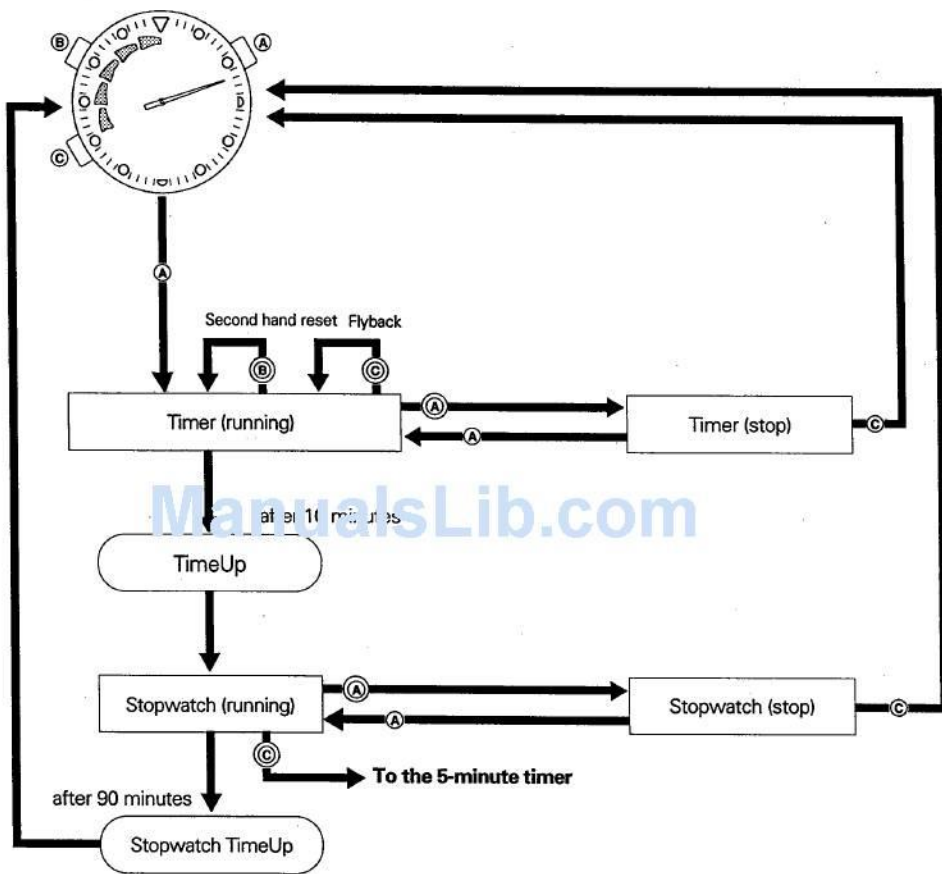

- ☆ Switching to the 5-minute timer is possible only while the stopwatch is running. (If switched while stopwatch is stopped, timer will go to 10-minute standby mode.)
- ☆ Elapsed time display changes as watch switches from timer to stopwatch:
Stopwatch minutes—read off the circular graphic display minute scale
Stopwatch seconds—read off the second hand
- ☆ In timer standby mode, the current time is displayed.
- ☆ When the timer is running, the hour/minute hands display the current time; the second hand displays the timer countdown in seconds.

- ☆ Once the timer is started, it will compensate for time lost while the graphic display panel moves into the correct position. Elapsed time data is accurately displayed on the graphic display panel.

Setting the R-3 timer

Setting procedures

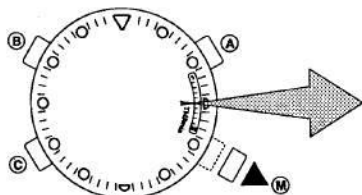

Pull the **M** button out to the 1st step position

- Timer settings for 3, 5, 10, 15 minutes are possible on the circular graphic display minute scale.
- After selecting the timer setting push the **M** button in to the normal position. The timer setting will now be displayed on the graphic display panel as in the R-1 and R-2 timer modes.
- Time conversion from the circular graphic display minute scale to the graphic display panel.

3 minutes

5 minutes

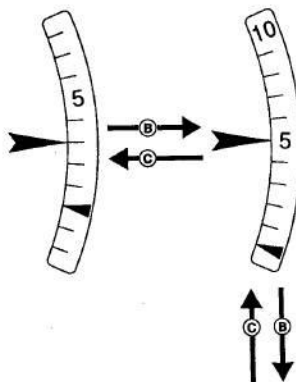

15 minutes

10 minutes

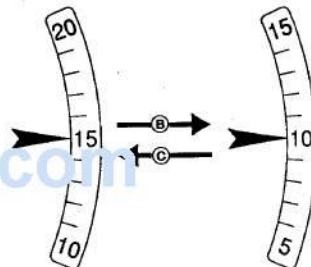

Circular graphic display minute scale

3 min. _____
 5 min. _____
 10 min. _____
 15 min. _____

Graphic display panel

3 red, 2 white
 5 red
 5 blue
 5 white

4. USING RACE MODE 3

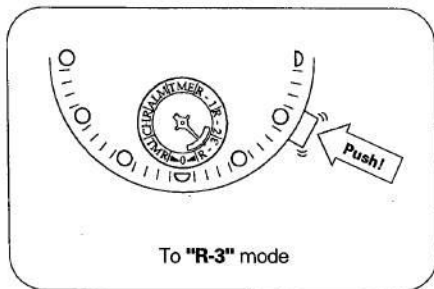

Race mode 3

- R-3 timer (1)
- Second hand reset function (2)
- Flyback feature (3)
- TimeUp confirmation beep (4)

Race mode 3 Features

(1) R-3 timer

- R-3 timer settings for 3, 5, 10, 15 minutes are possible by pulling out the **M** button to the 1st step position. See pg 24.
- Time remaining during timer countdown is displayed on the graphic display panel.
- ☆ The timer countdown hand (second hand) moves counterclockwise subtracting time from the timer setting.

(2) Second hand reset

(3) Flyback — timer reset feature

(4) TimeUp confirmation beep

- (2), (3) are the same as in Race mode 1. (4) is the same as in Race mode 1, 2, with an additional warning beep 10 minutes before time up. See pg 16, 17

5. SETTING THE TIMER

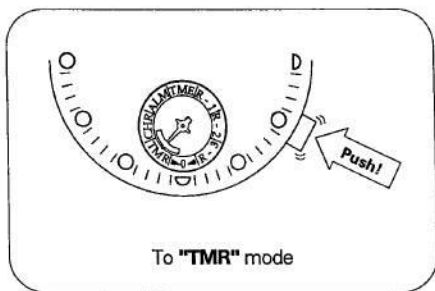

- Set the timer using the circular graphic display minute scale.
- **Timer calibration:** 1-second increments
- **Maximum time range:** 90 minutes in 1-minute increments
The "0" position is used as the "90-minute" setting.

Using the timer

Ex. 15 minute setting

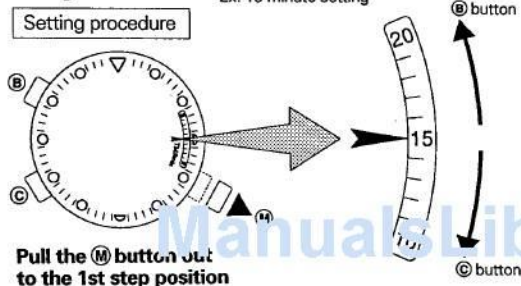

- Flyback feature See pg 18
- ☆ The timer countdown hand (second hand) moves counterclockwise subtracting time from the timer setting.
- After settings are complete push the **M** button in to the normal position.

Timer standby mode

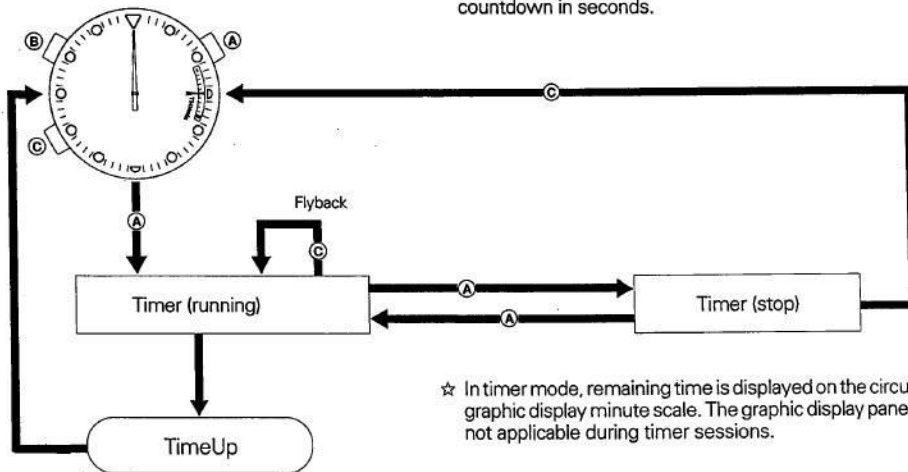

Using the R-3 timer — Example: 3 minute setting

Setting procedures

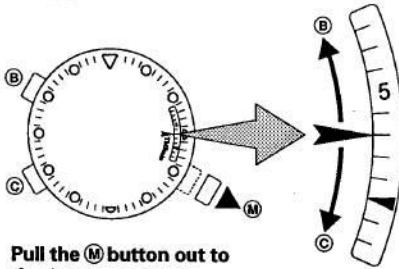

Pull the (M) button out to the 1st step position

- After settings are complete push the (M) button in to the normal position.

Timer standby mode

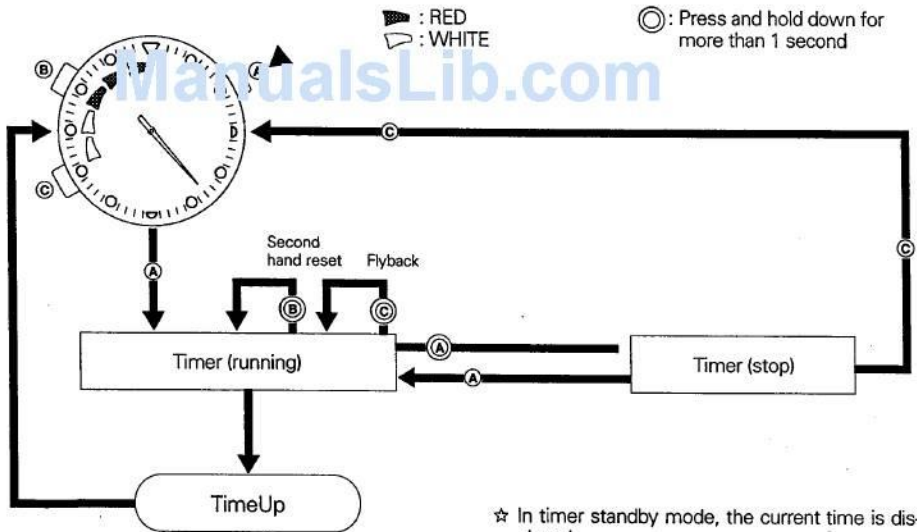

- ☆ In timer standby mode, the current time is displayed.
- ☆ When the timer is running, the hour/minute hands display the current time; the second hand displays the timer countdown in seconds.
- ☆ Once the timer is started, it will compensate for time lost while the graphic display panel moves into the correct position. Elapsed time data is accurately displayed on the graphic display panel.

7. SETTING THE ALARM

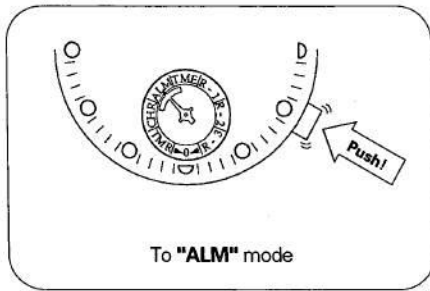

- Once the alarm has been set it will sound everyday at the same time for 15 seconds.

Setting procedures

- 1) (M) button normal position
- 2) Pull the (M) button out to the 1st step position
- 3) • Press the (B) button to move hour/minute hands **clockwise**.
• Press the (C) button to move hour/minute hands **counterclockwise**.

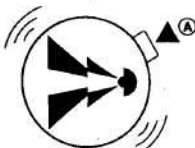
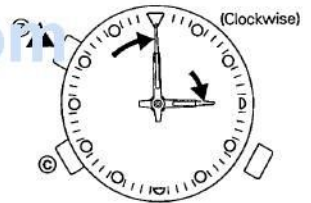
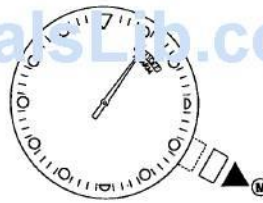

Sound monitor
5 seconds

- Pull the (M) button out to the 1st step position and the alarm is automatically turned ON.
- Press the (A) button when the (M) button is in the 1st step position to select OFF or ON.

Press and hold down the (B) or (C) button to use the quick-advance feature.

6. STOPWATCH OPERATION

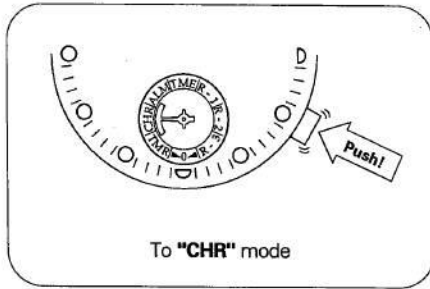

- **Stopwatch calibration:**
1-second increments
- **Maximum time range:**
90 minutes; Operation automatically stops after 90 minutes
- **Minutes display:**
easy-to-read the circular graphic display minute scale
- **Seconds display:** second hand
- The current time is displayed by hour and minute hand while in stopwatch mode.

Using the Stopwatch

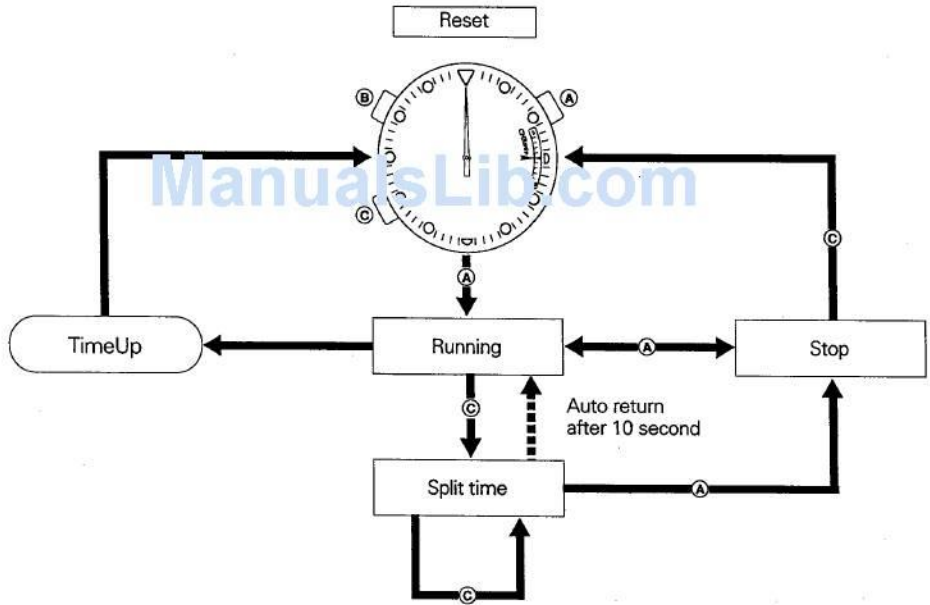

§5 ROTATING BEZEL

Many yacht races are set in triangulated course layouts such as the one described here where the winner is the boat that navigates the designated course around the marks in the fastest time.

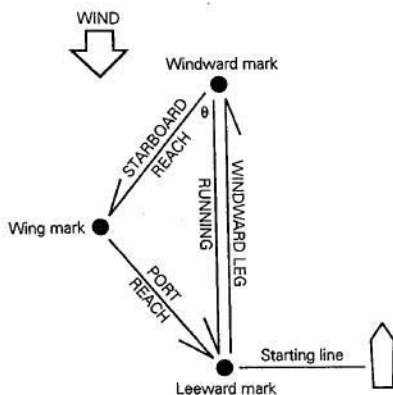

Direction:

Navigational bearings are most often given in terms of degrees.

North: 0° East: 90° South: 180°

West: 270°

Starboard:

The right-hand side of a yacht looking forward.

Port:

The left-hand side of a yacht looking forward.

Using the rotating bezel (1)

- Before a race, determine the direction of the wind from the direction and position of the windward marker. Line up the number representing the wind direction (in degrees) on the bezel with the triangle (Δ) mark at 12 o'clock. (Ex.: northeasterly wind at 45°).
- The course bearing from the windward mark to the wing mark (starboard reach) is read off the bezel, in degrees, at the green triangle (Δ) on the bottom left side of the dial.
- The course bearing from the wing mark to the leeward mark (port reach) is read off the bezel, in degrees, at the red triangle (Δ) on the bottom right.
- When sailing from the windward mark to the leeward mark, the small, white triangle at the bottom of the watch dial becomes the reference point for determining course bearings.

By following the procedures above to determine the course bearings, the proper bearings to the markers can be determined even during poor visibility when the course markers cannot be seen.

Note that the above explanation is only valid for times when the θ angle is 45°. At 60°, use the values lying above the red and green triangles; at 30°, use the values lying below the two triangles.

8. MONITORING IN THE NORMAL TIME MODE

Alarm set time monitor

Press the **(B)** button while in the normal time mode to monitor the alarm setting.

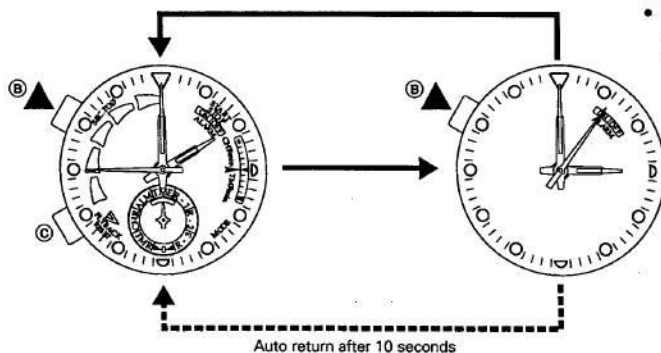

- Press the **(B)** or **(C)** button to return to the normal time mode from the alarm monitoring mode.

9. ALL RESET FUNCTION

The all reset function is used after battery changes or when watch movement is less than normal.

- 1) The all reset function can be activated in any mode.
Pull the **(M)** button out to the 1st step position.
- 2) Push and hold down the **(A)**, **(B)**, **(C)** buttons simultaneously for more than 2 seconds.
Release all three buttons and a confirmation beep will sound.
Push the **(M)** button in to the normal position after the above procedures are complete and set the watch to zero in the Zero position confirmation mode. **See** Zero position setting, pg 15.

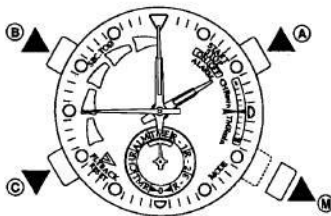

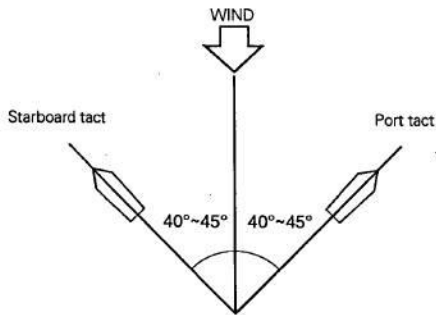

Using the rotating bezel (2)

Most present-day yachts are capable of sailing at 45° to the wind.

To be in a position of being able to read the wind shift after the start of a race, make several runs before the race matching your course as close as possible to the red (or green) bars on the left (or right) upper portion of the watch face.

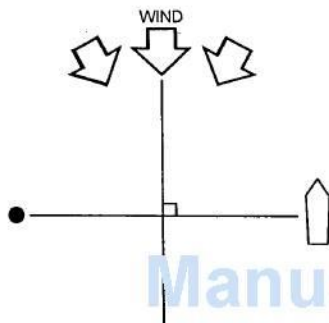

Using the rotating bezel (3)

By using the rotating bezel in the following way you can determine the angle between the start/finish line and the direction from which the wind is blowing.

The start/finish line is usually set at right angles to the direction of the wind, but because the wind is always shifting direction, it is a rare occasion when a true 90° angle is met.

In this case, line up the white triangle at the 12 o'clock position on the watch with the direction from which the wind is blowing. Sail from one end of the start/finish line to the other, using the white lines marked (at 3 or 9 o'clock) on the watch to site your destination. If the course steered falls on the plus (+) side of the white line, you are on a favorable heading to start the race when you cross the start/finish line.

If the course steered falls to the minus (-) side of the white line on the watch, you know it is favorable to cross the start/finish line on a heading from the opposite direction.

Use any one or a combination of the three methods described above to help you maneuver your boat into and maintain the position you feel is the most advantageous during a race.

4 FITTING PROCEDURE OF HANDS

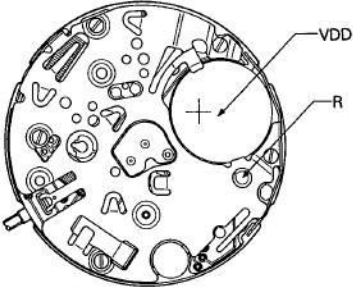
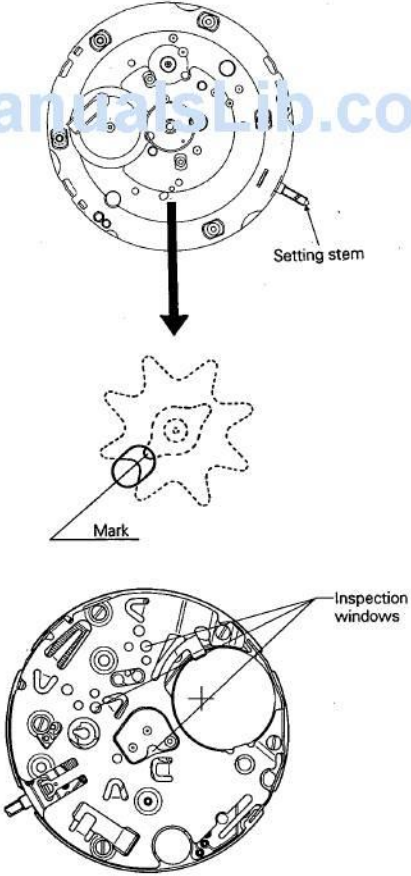
Step	Explanatory illustration	Remarks
<p>① Perform all reset.</p>		<p>Electrically connect position (+) side of power cell with (R) pattern for more than 2 seconds.</p>
<p>② Set module to "0" position confirmation mode.</p>		<p>a) Push the setting stem until the mark of the mode wheel is set as shown in the figure, watching through the inspection windows on the underside of the plate.</p> <p>b) Confirm that the train wheel is stopped, watching through the inspection windows on the train wheel bridge side. If it is moving, push the setting stem four times, then confirm the mode wheel mark again.</p> <p>* After setting, do not push the setting stem until the mode hand has been fitted.</p>

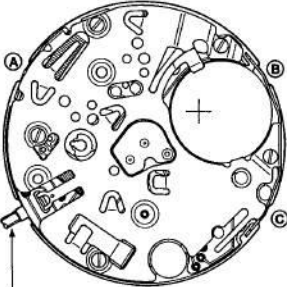

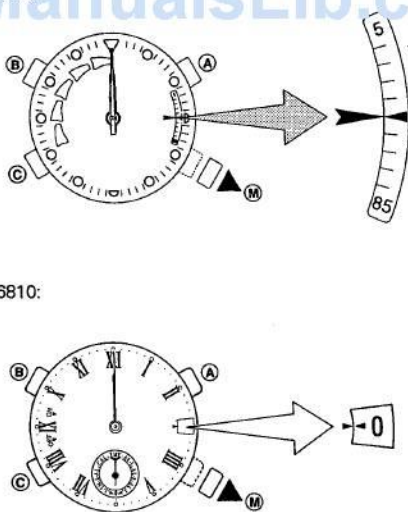
Step	Explanatory illustration	Remarks
<p>3 Install the hour wheels and related parts. Perform the same procedure for 6840 and 6810.</p>		<p>This part is equivalent to the intermediate disk wheel (4) in 6840 and the intermediate date wheel (4) in 6810 are the same part.</p>
<p>4 Install the disk, dial guard and disk guard.</p>		<p>The disk and disk guard in 6840 are respectively equivalent to the date dial and date dial guard in 6810.</p>
<p>5 Install the dial. Perform the same procedure for 6840 and 6810.</p>	<p>ManualsLib.com</p>	<p>Install the dial spacer to the</p>
<p>6 Confirm the 0 mode. Perform the same procedure for 6840 and 6810.</p>	 <p>Switching stem</p>	<p>With the switch stem at the normal position, push any one of (A), (B), and (C) buttons to confirm the demonstrative movement of the disk (6840) or the date dial (6810).</p> <p>* If the hand does not demonstrate:</p> <ol style="list-style-type: none"> Push the switching stem one time. Push any one of (A), (B), and (C) buttons. <p>Repeat a) and b) above until the hand demonstrates at b).</p> <p>* Demonstrative movement of hand</p> <p>6840: The disk moves up and down by 1 division on the basis of ► of the dial.</p> <p>6810: The date dial moves up and down on the basis of ► of the dial.</p>

Step	Explanatory illustration	Remarks
<p>7 Install the mode hand. Perform the same procedure for 6840 and 6810.</p>		<p>Install the mode hand to the center of print of ► 0 ◀</p>
<p>8 Install the hour, minute and second hands. Perform the same procedure for 6840 and 6810.</p>		<p>Install the hands to the following positions. Hour hand: 12 o'clock position Minute hand: 0 minute position Second hand: Any second division</p>
<p>9 Install the module to the case. Perform the same procedure for 6800 and 6850.</p>		
<p>10 Perform "0-position setting".</p>	<p>Fig. 3 C.</p>  <p>6840: Set the "◀ 0" mark of the disk to the "►" mark of the dial.</p> <p>6810: Set the "◀ 0" mark of date dial to the "►" mark of the dial.</p>	<p>1) Pull the (M) button.</p> <p>2) Push the (A) button to set the second hand to 0 second position (top of the dial).</p> <p>3) Push the (B) button to set the marks as follows. 6840: Set the "◀" mark of the disk to the "►" mark of the dial. 6810: Set the "◀ 0" mark of date dial to the "►" mark of the dial.</p> <p>4) Push the (C) button to set the minute hand to 0 minute position (top of the dial).</p> <p>5) Securely return the (M) button to the normal position.</p>
<p>11 Set the watch to the present time.</p>		<p>6810: Set the watch to the present time and calendar. (See "III. How to set time" and "IV. How to set calendar" in the Power Cell Replacement Procedure.)</p>



5 POWER CELL REPLACEMENT PROCEDURE

When replacing the power cell, be sure to measure the power consumption of the watch, without taking the module out of the case.

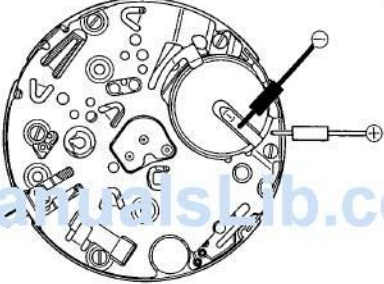
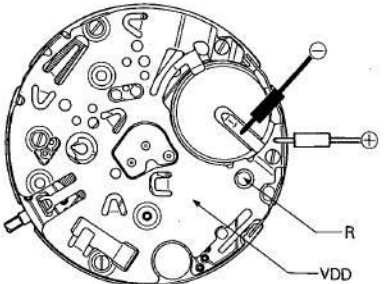

I. MEASUREMENT OF CURRENT CONSUMPTION

Step	Explanatory illustration	Remarks
<p>1 Set the watch to the time mode. Perform the same procedure for 6840 and 6810.</p>	<p>6840:  6810: </p>	
<p>2 Set the tester for measuring current consumption, and apply the lead bars of the tester to ⊕ and ⊖ of the module. Perform the same procedure for 6840 and 6810.</p>		<p>Keep the lead bars applied until the measurement is finished.</p> <p>⊕: Power cell strap ⊖: Power cell connector spring</p>
<p>3 Perform all reset. Perform the same procedure for 6840 and 6810.</p>		<p>Keep the lead bars applied, securely short the (R) terminal to power cell strap with pincers, etc. for more than 2 seconds.</p>
<p>4 Measure the current consumption. Perform the same procedure for 6840 and 6810.</p>	<p>*If there is any dirt or dust on any connecting part of the train wheel or circuit, the current consumption may be increased. Note this when measuring.</p>	<p>Read the current when the tester pointer is stabilized.</p> <p>2.0 μA max. (Both 6840 and 6810) → OK</p>
<p>5 Operation after power cell replacement. Perform the same procedure for 6840 and 6810.</p>	<p>After the power cell is replaced, the information in the IC in the watch is wrong. Perform the "0-position setting" to make each function work correctly.</p>	

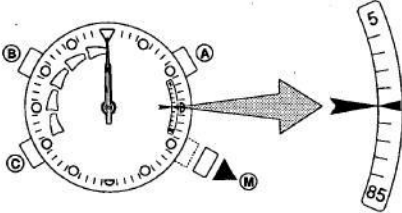
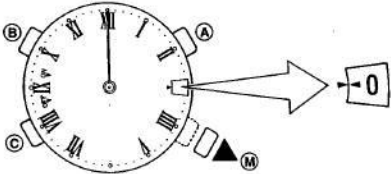
II.0-POSITION SETTING

Step	Explanatory illustration	Remarks
<p>1 Set the watch to the 0-position confirmation mode. Perform the same procedure for 6840 and 6810.</p>	<p>6840: </p> <p>6810: </p>	
<p>2 Perform the 0-position setting.</p>	<p>6840: </p> <p>6810: </p>	<p>a) Pull the M button.</p> <p>b) If the A, B, and C buttons are released;</p> <p>6840: A peeping alarm sound comes, and the second hand and disk move a little.</p> <p>6810: Each hand and date dial move for demonstration, then the alarm chimes.</p> <p>After the above operation is confirmed, perform the 0-position setting*.</p> <p>(See *10 perform 0-position setting.* in [4] FITTING PROCEDURE OF HANDS)</p>

III. SETTING THE PRESENT TIME

Step	Explanatory illustration	Remarks
<p>① Set the watch to the time mode. Perform the same procedure for 6840 and 6810.</p>	<p>6840: </p> <p>6810: </p>	
<p>② Set the watch to the present time.</p>	<p>6840: The illustration shows 6840.</p> 	<p>Perform the same procedure for 6840 and 6810.</p> <p>a) Pull the (M) button.</p> <p>b) Push the (A) button to return the second hand to 0.</p> <p>*When the (A) button is pushed, the minute hand moves as follows according to the position of the second hand.</p> <p>0 – 29 seconds: Minute hand does not advance.</p> <p>30 – 59 seconds: Minute hand moves by 1 minute.</p> <p>c) The hour hand and minute hand can be corrected clockwise with the (B) button.</p> <p>d) The hour hand and minute hand can be corrected counter clockwise with the (C) button.</p> <p>e) Securely return the (M) button to the normal position.</p>

IV. SETTING THE PRESENT CALENDAR

Step	Explanatory illustration	Remarks
① Set the watch to the calendar mode.	6810: 	6800: 6840 does not have the calendar function.
② Set the watch to the present calendar.		Date: In window at 3 o'clock position of the dial Month: Second hand a) Pull out the (M) button. b) Correct the month hand with the (A) button. c) Correct the date dial clockwise with the (E) button. d) Correct the date dial counter clockwise with the (C) button.

6 PRECAUTIONS FOR DISASSEMBLING AND ASSEMBLING

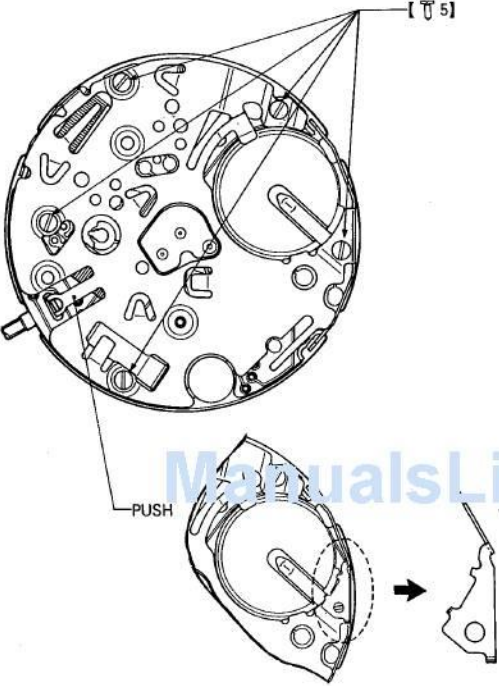
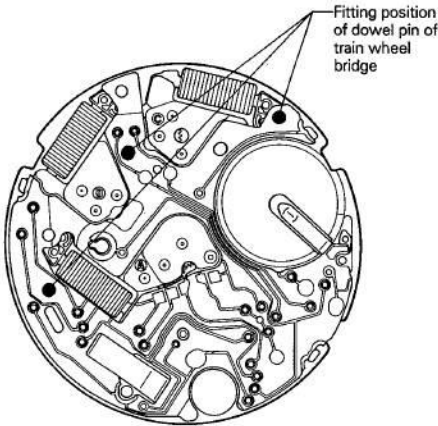
Disassembling procedure	Precautions
<p data-bbox="154 200 539 224">Perform the same procedure for 6840 and 6810.</p>  <p data-bbox="400 937 671 961">Fitting position of side pressure spring</p>	<ol style="list-style-type: none"><li data-bbox="744 208 954 232">1) Remove the power cell.<li data-bbox="744 247 1063 294">2) Remove the five mounting screws of the power cell strap.<ul style="list-style-type: none"><li data-bbox="768 318 1057 381">*1 Note that the following items are removed if these screws are removed.<ul style="list-style-type: none"><li data-bbox="780 404 930 428">• Power cell strap<li data-bbox="780 428 990 451">• Unit of electronic circuit<li data-bbox="780 451 894 475">• Train wheel<li data-bbox="768 490 1063 553">*2 Take care of the power cell side pressure spring on the power cell strap in 6840.<li data-bbox="744 577 1002 600">3) Remove the power cell strap.
<p data-bbox="160 984 545 1008">Perform the same procedure for 6840 and 6810.</p>  <p data-bbox="581 1055 689 1133">Fitting position of dowel pin of train wheel bridge</p>	<ol style="list-style-type: none"><li data-bbox="744 992 1063 1016">4) Remove the unit of electronic circuit.<ul style="list-style-type: none"><li data-bbox="768 1039 1087 1165">* The unit of electronic circuit is fitted to the dowel pin of the train wheel bridge. Since the train wheel bridge is not secured with any screw, press it when removing the unit of electronic circuit.

Disassembling procedure

Perform the same procedure for 6840 and 6810.

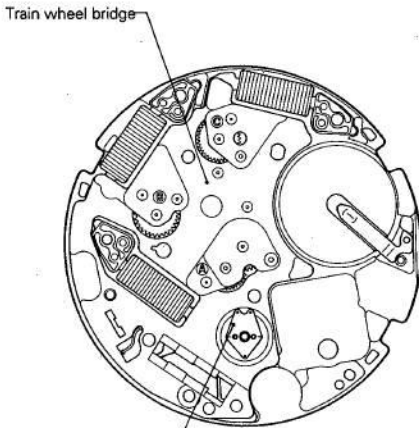

Mode changeover switch spring

Precautions

- 5) The "switch spring" is fitted to the two dowel pins of the mode wheel.

*When assembling, confirm that the two holes of the switch spring are fitted to the two dowel pins of the mode wheel.



ManualsLib.com

6840 and 6810: Take care when handling plastic parts.

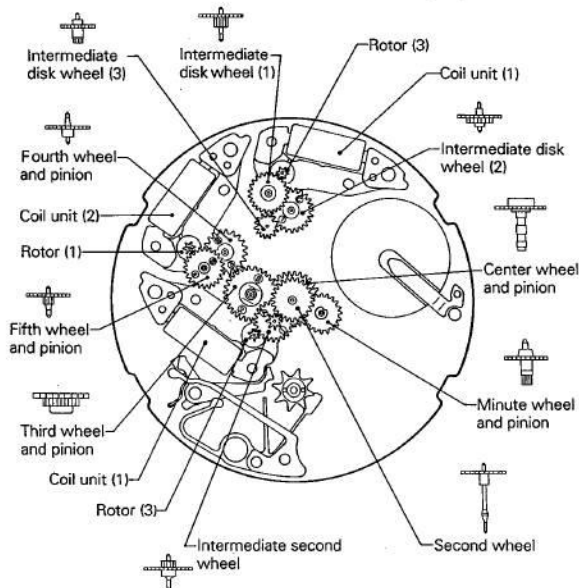

6840 and 6810: Same structure

- 6) The train wheel is divided into train wheel A, B, and C. Identification marks of A1 and B2 - B4 are stamped on them from the center wheel and pinion and second wheel and pinion at the center to the rotor. The disk wheels (1) and (3) of the train wheel C and the minute wheel and pinion (1) do not have any identification mark.

Wheel train A:

Rotor (3), Pinion: White, Seat: White, Coil (1), Color: Red

Wheel train B:

Rotor (1), Pinion: White, Seat: Gold, Coil (2), Color: Blue

Wheel train C:

Same as train A

- 7) Fit the third wheel and pinion holding spring to the top of the third wheel and pinion as shown below.



7 DISASSEMBLY AND ASSEMBLY OF THE MODULE

*These illustrations are based on Cal. 6820.

• Lubrication narjubgs

② : A-Lube oil

③ : V-Lube oil

④ : CH-1 oil

⑤ : F-Lube oil

Procedimiento de desmontaje ① → ⑧
Procedimiento de montaje ⑧ → ①

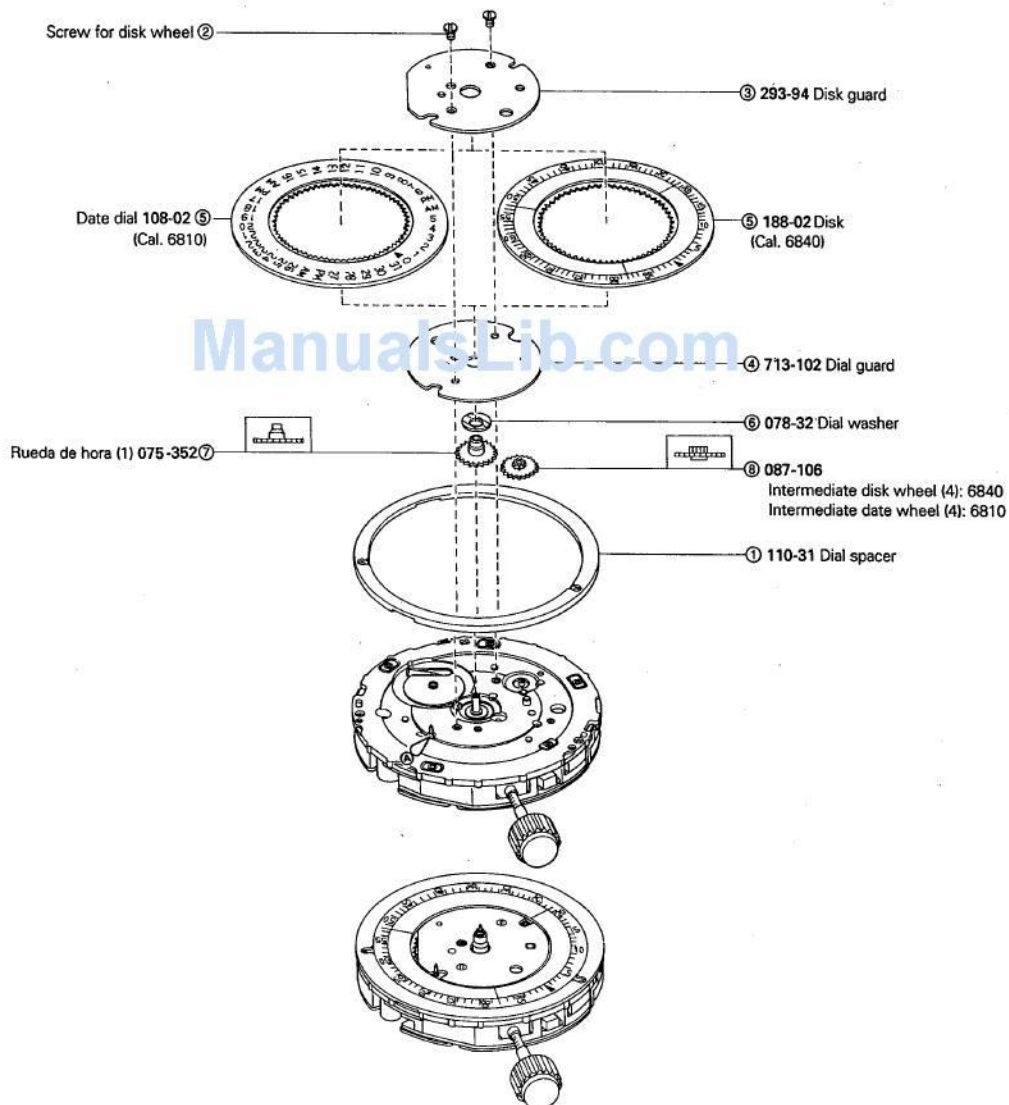

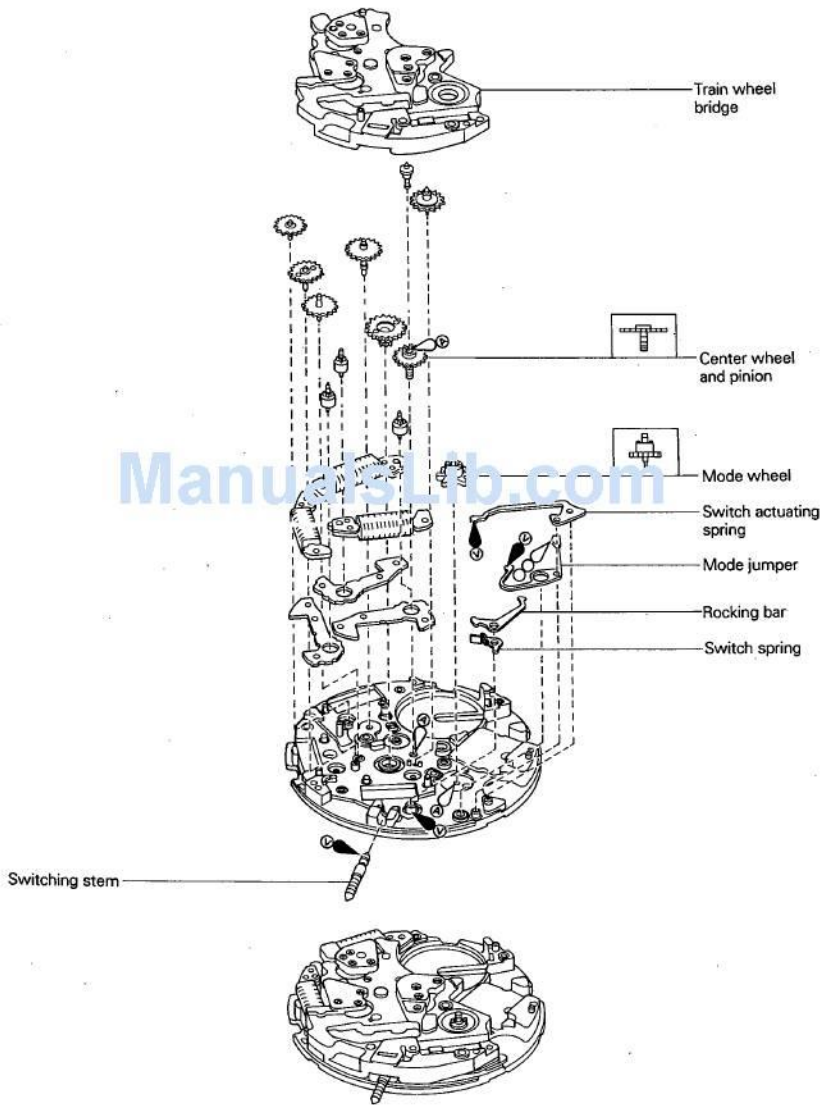

*These illustrations are based on Cal. 6820.
Check only parts to be lubricated.





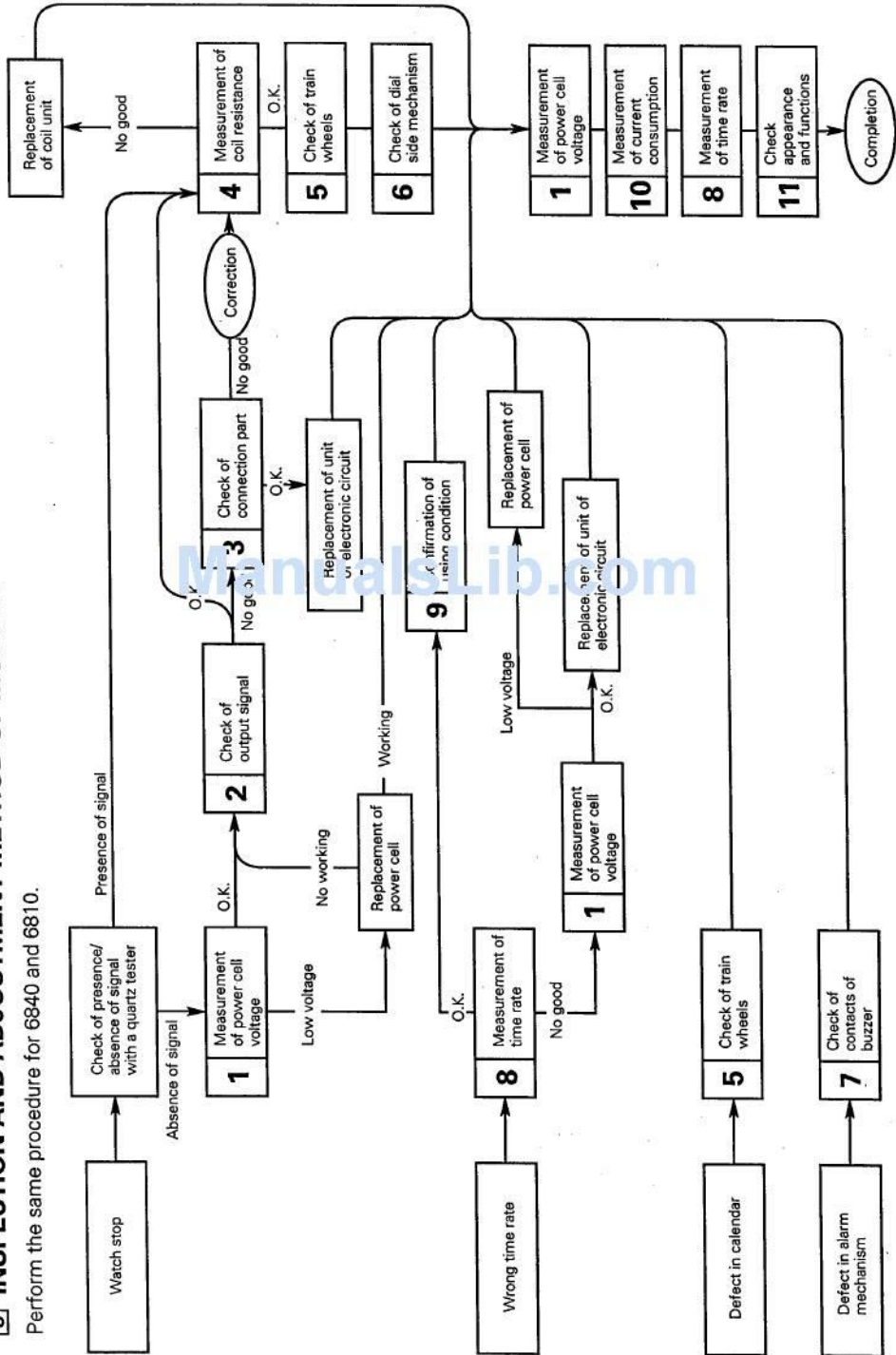

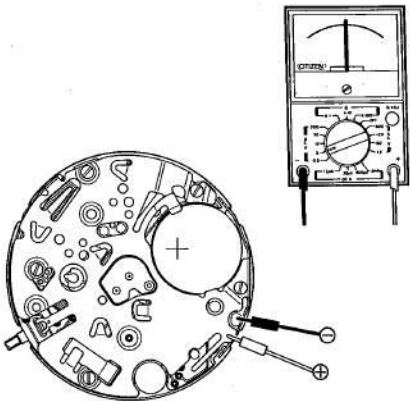
8 INSPECTION AND ADJUSTMENT METHOD OF MODULE

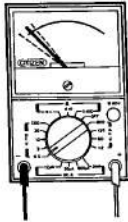
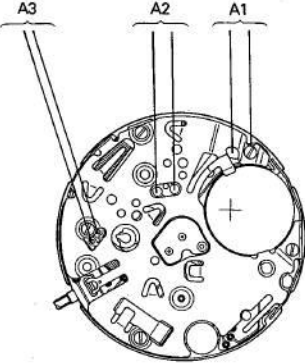

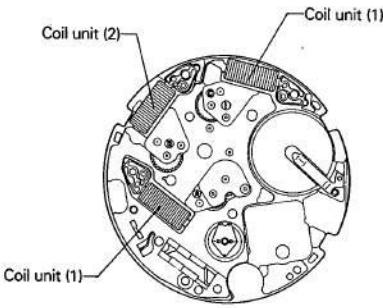
Perform the same procedure for 6840 and 6810.

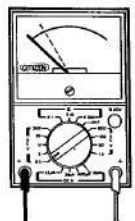

Check item	Method	Results and procedure
<p>❶ Measurement of power cell voltage</p> <p>Perform the same procedure for 6840 and 6810.</p>	<p>* Refer to Technical Manual, Basic Course II-1-a for the setting procedure of the tester.</p> <p><Tester range: DC 3V></p> 	<ul style="list-style-type: none"> ● Over 1.5 V → OK ● Under 1.5 V → Replace the power cell.
<p>❷ Check of output signal</p> <p>*Set watch to zero position confirmation mode.</p> <p>Perform the same procedure for 6800 and 6850.</p> <p>6840:</p>  <p>6810:</p> 	<p>* Refer to Technical Manual, Basic Course II-1-b for the setting procedure of the tester.</p> <p><Tester range: DC 0.3 V></p>  <p>(Measuring method) With the lead bars applied, push the push button.</p> 	<ul style="list-style-type: none"> ● A1 output signal Tester pointer swings. → OK ● A2 output signal Tester pointer swings. → OK ● A3 output signal Tester pointer swings. → OK

Check item	Method	Results and procedure
<p>④ Check of connection parts</p> <p>Perform the same procedure for 6840 and 6810.</p>	<p>*Refer to the analog part of Technical Manual, Basic Course II-2-a.</p> <p>If the output signal cannot be obtained for checking, dust may be caught between electronic circuit unit and each connection part. When the fixing screws of the electronic circuit unit are loosened, the output signal may not be obtained. Tighten those screws securely.</p>	<p>● Dust and dirt → Remove</p> <p>● Screws of each connecting part is loosened. → Tighten the screws.</p>
<p>④ Measurement of coil resistance</p> <p>Perform the same procedure for 6840 and 6810.</p>	<p>*Refer to Technical Manual, Basic Course II-1-c for the setting procedure of the tester.</p> <p style="text-align: center;"><Tester range: x 10Ω></p>  	<p>Resistance</p> <p>● Coil unit (1) 2.1 kΩ ~ 2.5 kΩ → OK</p> <p>● Coil unit (2) 1.2 kΩ ~ 1.5 kΩ → OK</p>
<p>⑤ Check of train wheel</p> <p>Perform the same procedure for 6840 and 6810.</p>	<p>*Refer to Technical Manual, Basic Course II-2-b.</p> <p>● Confirm each part of the plastic gears are not be bent or broken.</p> <p>Tenon and teeth of the plastic gears must be free from dirt, bend and breakage.</p>	<p>● If the train wheel is normal, replace the electronic circuit unit.</p> <p>The train wheel is normal. → Replace the electronic circuit unit.</p>
<p>⑥ Check of dial side</p> <p>Perform the same procedure for 6840 and 6810.</p>	<p>*Refer to Technical Manual, Basic Course II-2-c.</p> <p>● Each part of the plastic gears and pinions must not be bent or broken.</p>	

Check item	Method	Results and procedure
<p>⑦ Check of contacts of buzzer</p> <p>* Set the watch to alarm mode.</p> <p>6810: Set to Alarm 1, Alarm 2, Alarm 3 or Local Alarm mode.</p>  <p>6840:</p>  <p>Perform the same procedure for 6840 and 6810.</p>	<p>* Refer to Technical Manual, Basic Course II-1-d for the setting procedure of the tester</p> <p><Tester range: DC 3V></p>  <p>(Measuring method) Set the watch to the alarm mode and set the alarm monitor, then apply the ⊕ lead bar of the tester to the top of the battery and the ⊖ one to the buzzer contact spring.</p>  <p>If the part of the piezo-electric element stuck directly to the case back to which the buzzer contact spring will touch is cracked or broken, the alarm does not sound normally.</p> <p>Check the buzzer contact spring for deformation and fatigue.</p> <p>The booster coil must not be removed. If it is removed, the buzzer does not sound even if the tester pointer swings.</p>	<ul style="list-style-type: none"> ● Tester pointer swings. → OK ● Tester pointer does not swing at all. → Replace the electronic circuit unit. ● The piezo-electric element is cracked or broken. → Replace the case. ● The buzzer contact spring is deformed or fatigued. → Replace the buzzer contact spring. ● Removal of booster coil or floating of soldered part. → Replace the electronic circuit unit.

Check item	Method	Results and procedure
<p>8 Measurement of time rate</p> <p>* Set the watch to the time mode.</p> <p>Perform the same procedure for 6840 and 6810.</p> <p>6840:</p>  <p>6810:</p> 	<p>* Refer to Technical Manual, Basic Course II-2-d.</p> <p>Measure the time with CITIZEN QUARTZ TESTER.</p> <p>● Measurement of time rate The time can be measured with the tester in any range.</p> <p>Do not measure the time rate under the direct sunlight or incandescent lamp. If measured under them, the time rate may shift and may not be measured correctly.</p>	
<p>9 Confirmation of using condition</p>	<p>* Refer to Technical Manual, Basic Course II-2-e.</p> <p>● Since the accuracy may be affected by the environment of the watch, confirm the using condition of the watch (Magnetism, extremely high or low temperature and humidity, impacts, etc).</p> <p>● Confirm how many days have passed after the time was set last time.</p>	

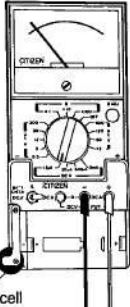
Check item	Method	Results and procedure
<p>⑩ Measurement of current consumption</p> <p>(Measuring method) Refer to the measurement of current consumption in Battery replacement procedure I.</p> <p>Perform the same procedure for 6840 and 6810.</p>	<p>* Refer to Technical Manual, Basic Course II-1-f for the setting procedure of the tester.</p> <p style="text-align: center;"><Tester range: DC 12μA></p> <div style="text-align: center;">  </div> <p style="text-align: center;">Power cell</p> <p>* If there is any dirt or dust on any connecting part of the train wheel or circuit, the current consumption may be increased.</p>	<ul style="list-style-type: none"> ● Under 2.0 μA → OK ● Over 2.0 μA → Replace the electronic circuit unit.
<p>⑪ Check of appearance and functions</p>	<p>Refer to Technical Manual, Basic Course II-2-f.</p> <ul style="list-style-type: none"> ● Confirm there is not dust, dirt, etc. on the dial. ● Confirm each push button works securely. 	

ManualsLib.com
CITIZEN WATCH CO., LTD.
Tokyo, Japan