

Watch Operation Guide 5748

CASIO®

Contents

About This Watch

General Guide

Watch Face Items

Navigating Between Modes

Mode Overview

Using the Crown

Hand and Day Indicator Movement

Charging

Viewing the Face in the Dark

Useful Features

Linking with a Phone

Getting Ready

Auto Time Correction

Setting the Alarm

Configuring Timer Settings

Correcting Hand and Day Indicator Alignment

Phone Finder

Configuring Watch Settings

Changing the Home City Summer Time Setting

Checking the Watch Charge Level

Recording Your Current Location
(TIME&PLACE)

Connection

Connecting with a Phone

Disconnecting from Your Phone

Using the Watch in a Medical Facility or
Aircraft

Unpairing

If you purchase another phone

Time Correction

Using Watch Operations to Correct the Time
Setting

Alarm

Using the CASIO WATCHES Phone App to
Configure Alarm Settings

Configuring Alarm Settings

Turning Off the Alarm

Stopwatch

Measuring Elapsed Time

Timer

Using the CASIO WATCHES Phone App to
Configure Timer Settings

Setting the Timer Start Time

Using the Timer

Hand and Day Indicator Alignment

Using the CASIO WATCHES Phone App to
Adjust Hand and Day Indicator Alignment

Correcting Hand and Day Indicator Alignment

Other Settings

Resetting Watch Settings

Specifications

Other Information

Summer Time Switching

Supported Phones

Copyrights and Registered Copyrights

Troubleshooting

Precautions

Operating Precautions

User Maintenance

Battery

Mobile Link Precautions

About This Watch

This section provides an overview of the watch and introduces convenient ways it can be used.

Watch Features

- **Phone Linking**

The watch supports connection and communication with a Bluetooth capable phone.

- **Solar Charging**

Sunlight and artificial light generate electricity for watch operation as it charges.

- **Alarm**

A beeper sounds when the alarm time you set is reached.

- **Stopwatch**

Measures up to 30 minutes of elapsed time in one-second increments.

- **Timer**

Countdown from a start time specified by you. An alarm sounds when the countdown reaches zero.

Note

- The illustrations included in this operation guide have been created to facilitate explanation. An illustration may differ somewhat from the item it represents.

General Guide

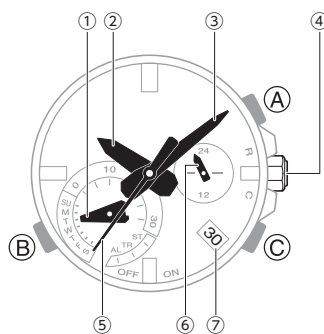

- ① Function hand
- ② Hour hand
- ③ Minute hand
- ④ Crown
- ⑤ Second hand
- ⑥ 24-hour hand
- ⑦ Day indicator

A button

In the Timekeeping Mode or Alarm Mode, press to illuminate the face.

B button

Each press cycles between watch modes. In any mode, hold down this button for at least one second to return to the Timekeeping Mode.

C button

Press when paired with a phone to sync the watch's time setting with the phone's setting.

Watch Face Items

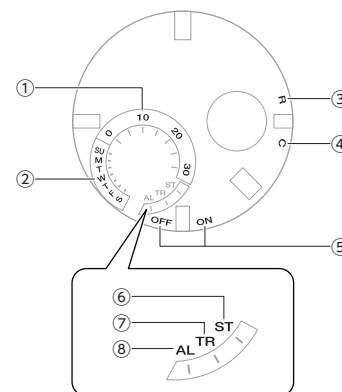

- ① **Measurement**
In the Stopwatch Mode and Timer Mode, the function hand indicates the measurement value.
- ② **Day of week**
In the Timekeeping Mode, the function hand indicates the current day of the week.
- ③ **[R]**
When the watch is standing by for connection with a phone, the second hand points to [R].
- ④ **[C]**
The second hand will point to [C] if the watch is connected with a phone.
- ⑤ **Alarm on/off setting**
In the Alarm Mode, the second hand indicates if the alarm is enabled or disabled.
[ON]: Alarm enabled
[OFF]: Alarm disabled
- ⑥ **[ST]**
The function hand momentarily points to [ST] when you enter the Stopwatch Mode.
- ⑦ **[TR]**
The function hand momentarily points to [TR] when you enter the Timer Mode.
- ⑧ **[AL]**
In the Alarm Mode, the function hand points to [AL].

Navigating Between Modes

Each press of (B) cycles between watch modes.

- Hold down (B) for at least one second to enter the Timekeeping Mode.
- After you enter the Stopwatch Mode or Timer Mode, the function hand first points to the mode name and then indicates the measurement value.

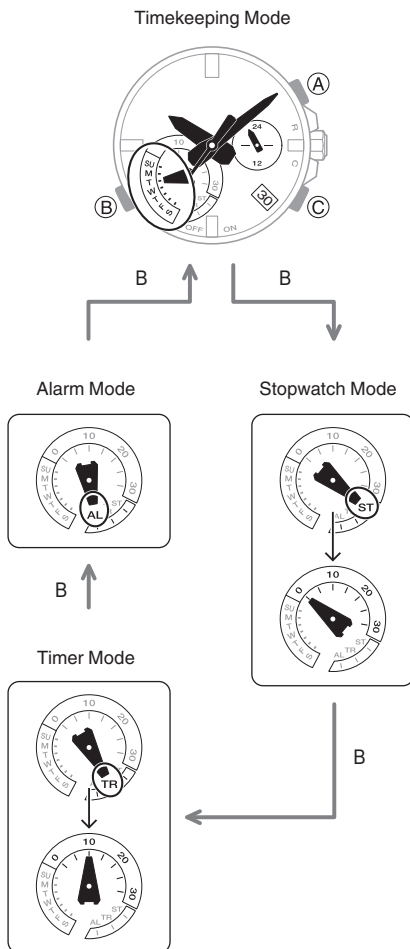

Connecting with a Paired Phone

Hold down (B) for at least 2.5 seconds to connect with a phone.

- To disconnect, press any button.

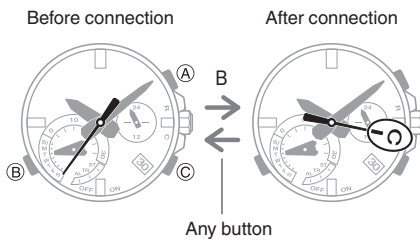

Mode Overview

Timekeeping Mode

The main hour, minute, and second hands indicate the current time.

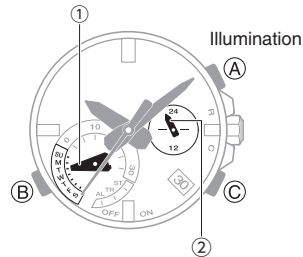

- 1 Day of the week at current location
- 2 Current location time (24-hour time)
One revolution every 24 hours.

Connecting with a Paired Phone to Correct the Watch's Time

Press (C).

Stopwatch Mode

The main hour and minute hands indicate the current time.

The function hand and second hand indicate the stopwatch measurement value.

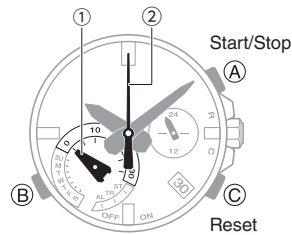

- 1 Stopwatch minutes
- 2 Stopwatch seconds

Timer Mode

The main hour and minute hands indicate the current time.

The function hand and second hand indicate the Timer measurement value.

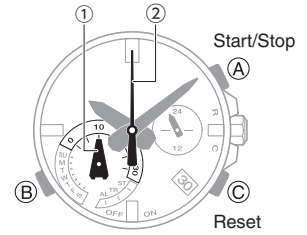

- 1 Timer minutes
- 2 Timer seconds

Alarm Mode

The hour hand and minute hand indicate the alarm time setting.

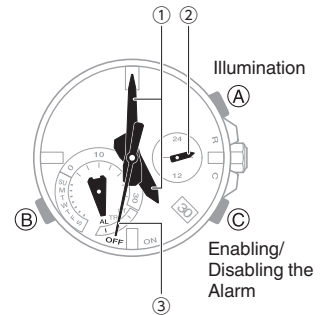

- 1 Alarm time
- 2 Alarm hour (24-hour time)
One revolution every 24 hours.
- 3 Alarm enabled/disabled

Using the Crown

The watch's crown is a screw-in (screw lock) type. To use the crown, you first need to rotate it towards you (leftwards) to loosen it.

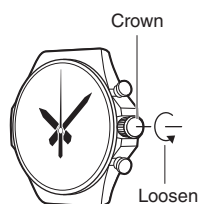

Important!

- To prevent loss of water resistance and/or damage due to impact, be sure to screw the crown in by rotating it away from you as you push it in.

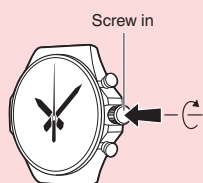

- When pushing the crown back in, take care not to apply too much force.

● Fast Forward/Fast Reverse

After pulling out the crown, rotating it quickly in succession in either direction will start a fast forward or fast reverse operation. While a fast forward operation is in progress, quickly rotating the crown in succession again will increase the speed even further.

● Stopping Fast Forward/Fast Reverse

Rotate the crown in the direction opposite that of the ongoing operation or press any button.

Note

- If you do not perform any operation for about two minutes after pulling out the crown, crown operations will automatically become disabled. If that happens, push the crown back in and then pull it out again.

Hand and Day Indicator Movement

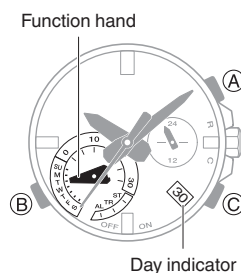

● Function Hand and Day Indicator Movement

Changing the day setting of the watch will also cause the function hand to move.

● Day

- It can take anywhere from about one to four minutes for the day indicator to change after timekeeping reaches midnight. At this time, the function hand moves as the day indicator changes.
- The day indicator does not change while measurement is in progress or paused in the Stopwatch Mode or Timer Mode.

Charging

This watch runs on power supplied from a rechargeable (secondary) battery that is charged by a solar panel. The solar panel is integrated into the face of the watch, and power is generated whenever the face is exposed to light.

● Charging the Watch

When you are not wearing the watch, put it in a location where it is exposed to bright light.



While you are wearing the watch, make sure that its face (solar panel) is not blocked from light by the sleeve of your clothing. Power generation efficiency is reduced even when the face of the watch is blocked only partially.

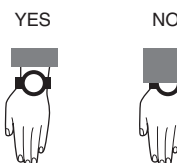

Important!

- Some light sources and environments can cause the watch to become extremely hot during charging, which creates the risk of burn injury and damage to internal watch components. Avoid charging the watch under conditions like the ones described below, where the temperatures may exceed 60 °C (140 °F).
 - On the dashboard of a vehicle parked in the sun
 - Near incandescent lamps, camera lights, halogen lamps, or other sources of heat
 - In locations exposed to direct sunlight for long periods and other hot locations

● Remaining Charge and Dead Battery

You can determine if the charge level is low by checking the hand movement. Functions become disabled as battery power goes low.

Important!

- Should the battery go low or go dead, expose the face (solar panel) to light as soon as possible.

Note

- Exposing the watch face to light after the battery goes dead will cause the second hand to revolve counterclockwise until it stops at second 57. This indicates charging has started.

Low Battery Power

The second hand jumps at two-second intervals.

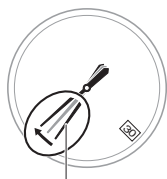

Second hand

Dead Battery

All hands and the day indicator are stopped.

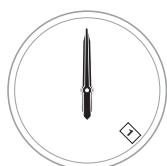

● Charging Time Guidelines

The table below shows guidelines for approximate charging times.

Charging Times Required for 1 Day of Operation

Light Level (Lux)	Approximate Charging Time
50,000	8 minutes
10,000	30 minutes
5,000	48 minutes
500	8 hours

Charge Recovery Times

- Sunny day, outdoors (50,000 lux)

Dead battery → Medium charge	2 hours
Medium charge → High charge	18 hours
High charge → Full charge	5 hours

- Sunny day, near a window (10,000 lux)

Dead battery → Medium charge	6 hours
Medium charge → High charge	67 hours
High charge → Full charge	18 hours

- Overcast day, near a window (5,000 lux)

Dead battery → Medium charge	8 hours
Medium charge → High charge	108 hours
High charge → Full charge	29 hours

- Indoor fluorescent lighting (500 lux)

Dead battery → Medium charge	94 hours
Medium charge → High charge	-
High charge → Full charge	-

Note

- Actual charging time depends on the charging environment, watch settings, and other factors.

● Power Saving

Leaving the watch in a dark location for about one hour between the hours of 10 p.m. and 5:50 a.m. will cause the second hand to stop, and the watch to enter Level 1 power saving. If the watch is left in this condition for six or seven days, all hands will stop at 12 o'clock and the watch will enter Level 2 power saving.

Level 1 :

Second hand stops to save power.

Level 2 :

The following operations are stopped to save power: all hand movement (excluding the day indicator), Bluetooth connection, and alarm alerts.

Note

- Note that the watch also may enter the power saving state if its face is blocked from light by your sleeve while you are wearing it.

Recovering from Power Saving Operation

Use one of the operations below to exit power saving.

- Press any button.
- Pull out the crown.
- Move the watch to a bright location.

Viewing the Face in the Dark

The watch has an LED light that you can turn on to illuminate the face. When turned on, illumination becomes gradually brighter and then gradually dimmer.

You can turn on the light in the Timekeeping Mode or Alarm Mode.

● Turning On Illumination

Press (A) to illuminate the face of the watch.

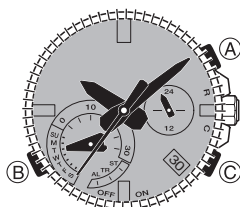

- Illumination turns off automatically if an alarm starts to sound.
- Illumination is disabled while the hands are moving at high speed.
- You can select either 1.5 seconds or three seconds as the illumination duration.

[Configuring Watch Settings](#)

Useful Features

Pairing the watch with your phone makes a number of the watch's features easier to use.

Auto time correction

[Auto Time Correction](#)



In addition, a number of other watch settings can be configured using your phone.

To transfer data to a watch and to configure settings, you first need to pair the watch with your phone.

[Getting Ready](#)

- Your phone needs to have the “CASIO WATCHES” phone app installed to pair with the watch.

Linking with a Phone

While there is a Bluetooth connection between the watch and phone (Mobile Link), the watch's current time setting is corrected automatically. You can also change the watch's other settings.

Note

- This function is available only while the CASIO WATCHES phone app is running on the phone.
- This section describes watch and phone operations.
 - : Watch operation
 - : Phone operation

Getting Ready

To use your watch in combination with a phone, you first need to pair them. Perform the steps below to pair the watch with a phone.

- ① Install the app on your phone.
- ② Configure Bluetooth settings.
- ③ Pair the watch with a phone.

● ① Install the required app on your phone.

In Google Play or the App Store, search for the “CASIO WATCHES” phone app and install it on your phone.

Important!

- To pair the watch, you must first install the “CASIO WATCHES” app and log in with a CASIO ID. If you already have a CASIO ID, use it to log in. If you do not have a CASIO ID, follow the on-screen instructions to register a new one and then use it to log in.

● ② Configure Bluetooth settings.

Enable the phone's Bluetooth.

Note

- For details about setting procedures, see your phone documentation.

● ③ Pair the watch with a phone.

1. Move the phone to be paired with close to (within one meter of) the watch.
2. Tap the “CASIO WATCHES” icon.
3. Tap the **+** of the “My Watch” tab.
4. Perform the operation shown on the phone screen to register the watch to the CASIO WATCHES phone app.
5. Hold down (B) for at least 2.5 seconds until the second hand points to [R].

When pairing is complete, the second hand will move to [C].

At this time the time settings of your phone and watch are synced with each other.

- If pairing fails, the watch returns to the Timekeeping Mode. Perform the pairing procedure again from the beginning.

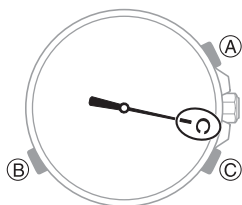

This completes the pairing operation. Once paired, the smartphone and watch automatically connect to synchronize the watch's time setting with that of the smartphone.

Note

- The first time you start up the CASIO WATCHES phone app, a message will appear on your phone asking if you want to enable location information acquisition. Configure settings to allow background use of location information.

Auto Time Correction

Your watch connects with a phone at preset times each day and correct its time settings automatically.

● Using This Function

Your watch corrects its time setting four times a day according to a preset schedule. If you leave your watch in the Timekeeping Mode, it will perform the correction operation automatically as you go about your daily life, without any operation required by you.



Important!

- Note that the watch will not perform auto time correction if it enters the Timekeeping Mode while any one of the conditions below exists.
 - Battery power is low.
 - Watch is in Level 2 power saving.
 - While the watch is too far away from its paired phone
 - While communication is not possible due to radio interference, etc.
 - While the phone is updating its system

Note

- If the watch does not indicate the correct time even if is able to connect with a phone, correct the hand and day indicator positions.
 - [Correcting Hand and Day Indicator Alignment](#)
- The watch connects with the phone and performs auto time correction at around 12:30 a.m., 6:30 a.m., 12:30 p.m. and 6:30 p.m. The connection is automatically terminated after auto time correction is complete.

● Triggering Immediate Time Correction

The watch's time setting is corrected automatically whenever you establish a connection between the watch and a phone. Whenever you want to trigger immediate time correction, perform the procedure below to connect with a phone.

1. Move the phone close to (within one meter of) the watch.
2. Hold down (C) for about 0.5 seconds. Release the button as soon as the second hand points to [R].

When the watch connects with a phone, the second hand moves to [C] and then the watch's time setting synchronizes with the phone's time.

- At this time your current location is recorded by your phone.
- The connection is terminated automatically after time correction is complete.

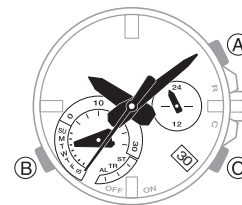

Setting the Alarm

1. Tap the "CASIO WATCHES" icon.
2. Hold down (B) for at least 2.5 seconds.
 - Hold down (B) until the second hand points to [R].
 - The second hand moves from [R] to [C] when a connection is established between the watch and phone.

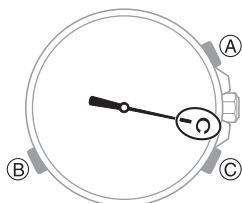

3. Perform the operation shown on the phone screen to configure alarm time settings.

Configuring Timer Settings

1. Tap the "CASIO WATCHES" icon.
2. Hold down (B) for at least 2.5 seconds.
 - Hold down (B) until the second hand points to [R].
 - The second hand moves from [R] to [C] when a connection is established between the watch and phone.

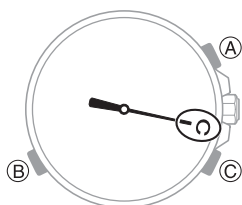

3. Perform the operation shown on the phone screen to configure the timer time setting.

Correcting Hand and Day Indicator Alignment

If the hands and/or day indicator are out of alignment even though auto time correction is being performed, you can use the CASIO WATCHES phone app to adjust them.

1. Tap the "CASIO WATCHES" icon.
2. Hold down (B) for at least 2.5 seconds.
 - Hold down (B) until the second hand points to [R].
 - The second hand moves from [R] to [C] when a connection is established between the watch and phone.

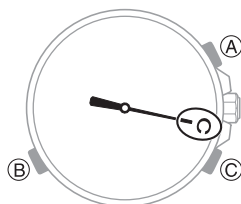

3. Perform the operation shown on the phone screen to correct hand and day indicator alignment.

Phone Finder

You can use phone finder to trigger a tone on the phone to make it easy to find. The tone is forced to sound even if the phone is in vibrate mode.

Important!

- Phone finder will not sound the tone unless the CASIO WATCHES phone app is running on the phone.
- Do not use this function in areas where phone call tones are restricted.
- The tone sounds at a high volume. Do not use this function when listening to phone output over earphones.

1. If the watch is connected with a phone, press any button to terminate the connection.

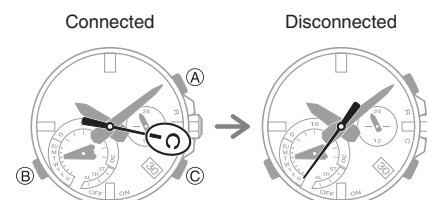

2. Hold down (B) for at least 1 seconds. This will cause the watch to enter the Timekeeping Mode.
3. Hold down (C) for at least 2.5 seconds until the second hand points to [R] twice. The second hand moves to [C] when a connection is established between the watch and phone, and then the phone's ring tone will sound.
 - It takes a few seconds before the phone tone sounds.

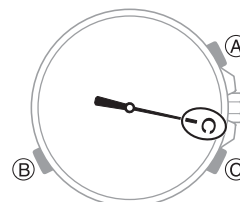

4. Press any button to stop the tone.
 - You can press any watch button to stop the phone tone, but only during the first 30 seconds after it starts to sound.

Configuring Watch Settings

After establishing a connection between the watch and a phone, you can use the CASIO WATCHES phone app to configure watch settings and to view information acquired by the watch.

1. Tap the "CASIO WATCHES" icon.
2. Hold down (B) for at least 2.5 seconds.
 - Hold down (B) until the second hand points to [R].
 - The second hand moves from [R] to [C] when a connection is established between the watch and phone.

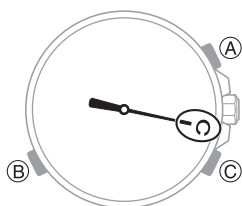

3. Select the setting you want to change and then perform the operation shown on the phone screen.

Changing the Home City Summer Time Setting

1. Tap the "CASIO WATCHES" icon.
2. Hold down (B) for at least 2.5 seconds.
 - Hold down (B) until the second hand points to [R].
 - The second hand moves from [R] to [C] when a connection is established between the watch and phone.

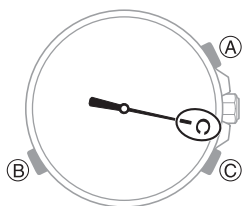

3. Perform the operation shown on the phone screen to change your Home City summer time setting.
 - [Summer Time Switching](#)

Checking the Watch Charge Level

Use the procedure below to check the current charge level with the CASIO WATCHES phone app.

1. Tap the "CASIO WATCHES" icon.
2. Hold down (B) for at least 2.5 seconds.
 - Hold down (B) until the second hand points to [R].
 - The second hand moves from [R] to [C] when a connection is established between the watch and phone.

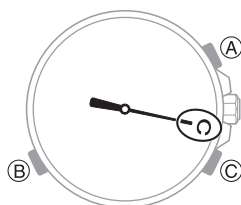

3. Use the CASIO WATCHES phone app to check the charge level.

Recording Your Current Location (TIME&PLACE)

While traveling or otherwise on the go, you can use the procedure below to record your current location, along with the time and date, on your phone. Recorded location information can be viewed on the CASIO WATCHES phone app map.

Recording Your Current Location

1. Enter the Timekeeping Mode.
 - [Navigating Between Modes](#)
2. When you are in the location you want to record, press (C).

This records, in phone memory, the latitude and longitude of the location you are in when you press the button, along with the date and time.

- When location recording is successful, the second hand performs one revolution and then points to [C] again. Next, watch syncs its time setting with your phone.

Viewing a Recorded Location on a Map

1. Tap the "CASIO WATCHES" icon.
2. Perform the operation shown on the phone screen to view recorded location information.

Note

- You can use the CASIO WATCHES phone app to delete recorded location information.

Connection

Connecting with a Phone

Your watch can connect with a phone that is paired with it.

- If the watch is not paired with the phone you want to connect with, refer to the information below and pair them.

③ Pair the watch with a phone.

● Connecting with a Phone

1. Move the phone close to (within one meter of) the watch.
2. While the second hand is not pointing to [C], hold down (B) for least 2.5 seconds.
 - Hold down (B) until the second hand points to [R].
 - The second hand moves from [R] to [C] when a connection is established between the watch and phone.

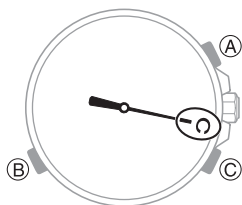

Important!

- If you have problems establishing a connection, it could mean that the CASIO WATCHES app is not running on your phone. On your phone's home screen, tap the "CASIO WATCHES" icon. After the app starts up, hold down the watch's (B) button for at least 2.5 seconds.

Note

- The connection is terminated if you do not perform any operation on the watch or phone for a fixed amount of time. To specify the connection limit time, perform the following operation with the CASIO WATCHES phone app: "Watch settings" → "Connection time with the app". Next, select a setting of 3 minutes, 5 minutes, or 10 minutes.

Disconnecting from Your Phone

Pressing any button terminates the Bluetooth connection and returns the second hand to its normal operation.

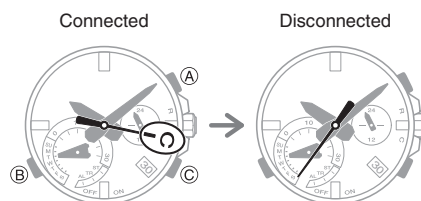

Using the Watch in a Medical Facility or Aircraft

Whenever you are in a hospital, on an aircraft, or in any other location where connection with a phone may cause problems, you can perform the procedure below to disable auto time correction. To re-enable auto time correction, perform the same operation again.

1. Tap the "CASIO WATCHES" icon.
2. Hold down (B) for at least 2.5 seconds.
 - Hold down (B) until the second hand points to [R].
 - The second hand moves from [R] to [C] when a connection is established between the watch and phone.

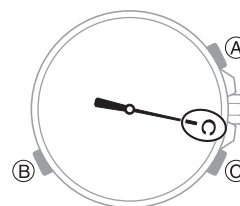

3. Perform the operation shown on the phone screen to enable or disable auto time correction.

Unpairing

Unpairing the watch from a phone requires both the CASIO WATCHES phone app and watch operations.

● Deleting Pairing Information from the CASIO WATCHES phone app

1. If the watch is connected with a phone, press any button to terminate the connection.

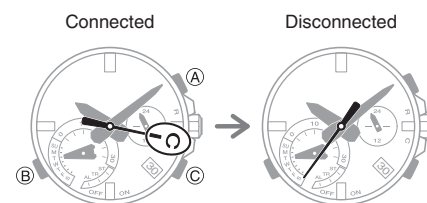

2. Tap the "CASIO WATCHES" icon.
3. Perform the operation shown on the phone screen to unpair.

● Deleting Pairing Information from the Watch

1. Enter the Timekeeping Mode.
[🔍 Navigating Between Modes](#)
2. Loosen the crown and then pull it out.
 The second hand points to 12 o'clock.

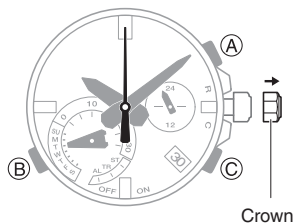

3. Hold down (C) for at least 10 seconds.
 The second hand points to [C] when the pairing information is deleted.

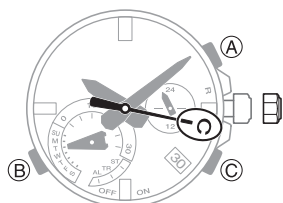

4. Push the crown back in and then lock it.

▮ If you purchase another phone

You need to perform the pairing operation whenever you want to establish a Bluetooth connection with a phone for the first time.

- [🔍 Deleting Pairing Information from the Watch](#)
- ③ [Pair the watch with a phone.](#)

Time Correction

Your watch can connect with a phone to obtain information that it uses to correct its date and time setting.

Important!

- When you are on an aircraft or in any other location where radio signals may cause problems, enable the watch's Airplane Mode to disable connection with your phone.
[🔍 Using the Watch in a Medical Facility or Aircraft](#)

Referring to the information below, configure the time setting in accordance with the method that suits your own lifestyle.

Do you use a phone?

Time correction by connecting with your phone is recommended.

- [🔍 Getting Ready](#)
- [🔍 Auto Time Correction](#)

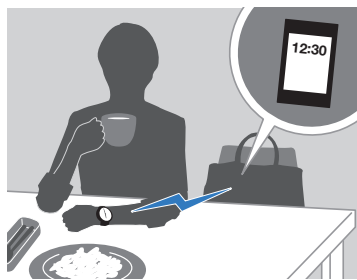

If your phone cannot connect with the watch

You can correct time settings by performing operations on the watch.

- [🔍 Using Watch Operations to Correct the Time Setting](#)



Using Watch Operations to Correct the Time Setting

While the watch is connected to a phone, it will automatically correct its day and time settings to those of the phone. If the watch is not connected to a phone, use the procedure below to adjust its day and time settings.

1. Enter the Timekeeping Mode.
[🔍 Navigating Between Modes](#)
2. Loosen the crown and then pull it out.
 This causes the second hand to move to 12 o'clock and enables the hour and minute setting operation.

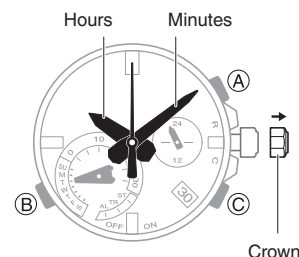

3. Rotate the crown to adjust the hour and minute settings.
4. Press (B).
 This enables the year 10's digit setting operation.
5. Rotate the crown to change the year 10's digit.

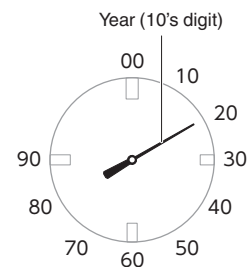

6. Press (B).
 This enables the year one's digit setting operation.

- Rotate the crown to change the year one's digit.

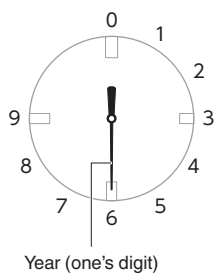

- Press (B).
This enables the month setting operation.
- Rotate the crown to change the month.

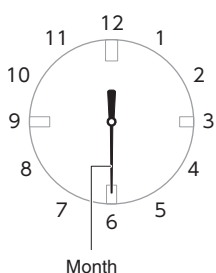

- Press (B).
This enables the day setting operation.
- Rotate the crown to change the day.

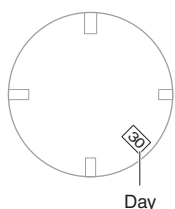

- On a time signal at the top of a minute, push the crown back in and lock it.

Note

- The day of the week is set automatically in accordance with the year, month, and day settings.

Alarm

The watch will beep when the alarm time is reached.

- The beeper is muted in the cases described below.
 - When battery power is low
 - When the watch is at Level 2 power saving
- [Power Saving](#)



Using the CASIO WATCHES Phone App to Configure Alarm Settings

If the watch is paired with a phone, you can also use the CASIO WATCHES phone app to set alarms.

- [Setting the Alarm](#)

Configuring Alarm Settings

- Enter the Alarm Mode.
[Navigating Between Modes](#)
- Loosen the crown and then pull it out.
This turns on the alarm.
- Rotate the crown to change the alarm time setting.

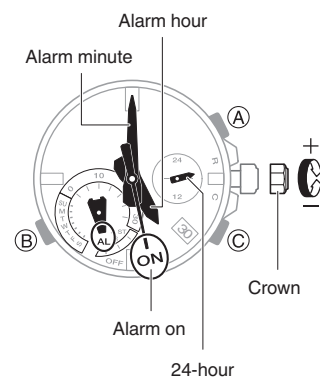

- Push the crown back in and then lock it.

Note

- A beeper sounds for 10 seconds when an alarm time is reached.
- The watch automatically returns from the Alarm Mode to the Timekeeping Mode if you do not perform any operation for about two or three minutes.

● To stop the alarm

To stop the alarm after it starts to sound when an alarm time is reached, press any button.

Turning Off the Alarm

To stop the alarm from sounding, perform the steps below to turn it off.

- To have the alarm sound again, turn it on.

1. Enter the Alarm Mode.
[🔍 Navigating Between Modes](#)
2. Use (C) to move the second hand to [OFF].

- Each press of (C) toggles between on and off.

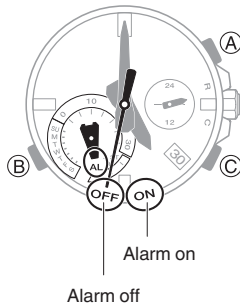

Stopwatch

Measures up to 30 minutes of elapsed time in one-second increments.



Measuring Elapsed Time

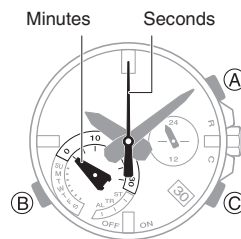

1. Enter the Stopwatch Mode.
[🔍 Navigating Between Modes](#)
2. Use the operations below to measure elapsed time.

- Ⓐ Start
- ↓
- Ⓐ Stop
- ↓
- Ⓐ Resume
- ↓
- Ⓐ Stop

3. Press (C) to reset the time to zero.

Timer

The timer counts down from a start time specified by you. A beeper sounds when the end of the countdown is reached.

- The beeper is muted when battery power is low.



Using the CASIO WATCHES Phone App to Configure Timer Settings

If the watch is paired with a phone, you can also use the CASIO WATCHES phone app to set the timer start time.

- 🔍 [Configuring Timer Settings](#)

Setting the Timer Start Time

1. Enter the Timer Mode.
[🔗 Navigating Between Modes](#)
2. Loosen the crown and then pull it out.
 The hour, minute, second, and 24-hour hands temporarily move out of the way so you can view the display.
3. Rotate the crown to change the countdown start time setting.
 - The start time can be set in 1-minute units up to 30 minutes.

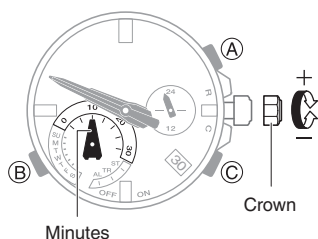

4. Push the crown back in and then lock it.

Using the Timer

1. Enter the Timer Mode.
[🔗 Navigating Between Modes](#)
2. Press (A) to start the timer countdown.

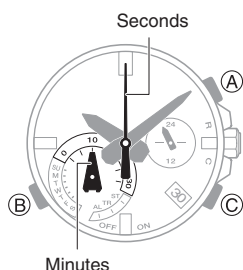

A beeper sounds for 10 seconds when the end of the countdown is reached.

- To pause an ongoing timer countdown, press (A). You can reset a paused timer countdown to its start time by pressing (C).
3. Press any button to stop the tone.

Hand and Day Indicator Alignment

Strong magnetism or impact can cause the hands and/or the day indicator to go out of alignment. If this happens, correct hand and day indicator alignment.

Using the CASIO WATCHES Phone App to Adjust Hand and Day Indicator Alignment

If the watch is paired with a phone, you can also use the CASIO WATCHES phone app to correct hand and day indicator positions.

- 🔗 [Correcting Hand and Day Indicator Alignment](#)

Correcting Hand and Day Indicator Alignment

1. Enter the Timekeeping Mode.
[🔗 Navigating Between Modes](#)
2. Loosen the crown and then pull it out.
 The second hand points to 12 o'clock.
3. Hold down (C) for at least five seconds.
 Release the button after the second hand completes one full rotation.
 This enables adjustment of second hand alignment.

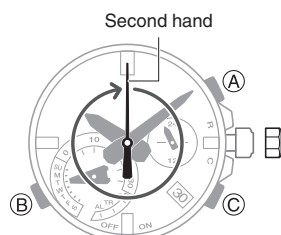

4. Rotate the crown to align the second hand with 12 o'clock.

5. Press (B).
 This enables adjustment of hour and minute hand alignment.

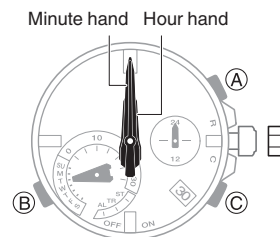

6. Rotate the crown to align the hour and minute hands with 12 o'clock.
7. Press (B).
 This starts the function hand indicator alignment operation.

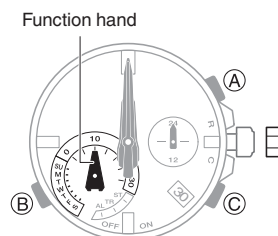

8. Rotate the crown to align the second hand with [10].

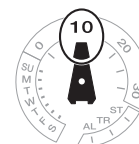

9. Press (B).
 This enables adjustment of day indicator alignment.

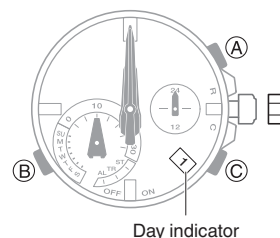

10. Rotate the crown to align [1] in the center of the day indicator.

- Rotating the crown also causes the function hand to move. Align the function hand with [10].

11. Push the crown back in and then lock it.

Note

- Leaving the crown pulled out for more than approximately 30 minutes without performing any operation will automatically cause the adjustment operation to become disabled. If this happens, push the crown back in to its normal position and then pull it out again to restart the procedure from the beginning. Pushing the crown in to its normal position part way through the alignment procedure will cause the hands to return to their normal position. Any alignment you performed up to that point will be applied.

Other Settings

This section explains other watch settings you can configure.

Resetting Watch Settings

This section explains how to return the watch settings below to their initial factory defaults.

- Watch Settings
- Stopwatch
- Timer
- Alarm

1. Enter the Timekeeping Mode.

🔗 [Navigating Between Modes](#)

2. Loosen the crown and then pull it out. The second hand points to 12 o'clock.

3. Hold down (A) for at least five seconds. After reset is complete, the watch will beep and the second hand will make one full rotation. About three seconds after that the second hand will make another full rotation.

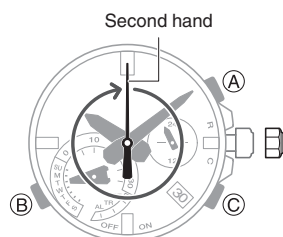

4. Push the crown back in and then lock it.

Specifications

Accuracy at normal temperature :

±15 seconds per month when time correction by communication with a phone is not possible.

Timekeeping :

Hour, minute (10-second hand movement), second, day (Full Auto Calendar 2000 to 2099), day of the week

Stopwatch :

Measuring unit: 1 second
Measurement range: 30 minutes
Measuring functions: Elapsed time

Alarm :

Daily alarm
Setting units: Hours, minutes
Beeper: 10 seconds

Timer :

Setting unit: 1 minute
Measurement range: 30 minutes
Measuring unit: 1 second
10-second beeper when the end of the countdown is reached

Mobile Link :

- Auto Time Correction
Time setting corrected automatically at preset time
- One-touch Time Correction
Manual connection and time correction
- Phone finder
Watch operation sounds the alert sound of the phone.
- Auto Summer Time Switching
Automatic switching between standard time and summer time
- Timer Settings
- Alarm Settings
- Hand alignment correction
- TIME&PLACE
- Data Communication Specifications
 - Bluetooth®
 - Frequency Band: 2400MHz to 2480MHz
 - Maximum Transmission: 0 dBm (1 mW)
 - Communication range: Up to 2 meters (depends on environment)

Other :

High-luminosity LED light (Super Illumination, afterglow)
 Power Saving
 Low Battery Alert

Power Supply :

Solar panel and one rechargeable battery
 (Type: CTL920)
 Battery nominal voltage: 2.3V

Approximate Battery Life :

Approximately 5 months
 Conditions
 Auto time correction using a smartphone:
 4 times/day
 Alarm: Once (10 seconds)/day
 Illumination: Once (1.5 seconds)/day
 Power Saving: 6 hours/day

Specifications are subject to change without notice.

Other Information

This section provides non-operational information you also need to know. Refer to this information as required.

Summer Time Switching

● Connecting with a Phone to Switch

While the watch is connected to a smartphone, the Home City time is adjusted according to the CASIO WATCHES app setting (Auto/ON/OFF), as described below.

Auto :

After the watch is connected with a phone and your Home City enters summer time, summer time is displayed as the current time.

Otherwise standard time is displayed.

ON :

The watch always displays summer time.

OFF :

The watch always displays standard time.

● Auto Summer Time Switching

Connecting the watch to your smartphone during the summer time period causes summer time information for your Home City to be sent from the phone. If the CASIO WATCHES summer time setting is "Auto", the watch will automatically keep track of the summer time period and perform summer time switching automatically, even if it is not connected with the phone.

Supported Phones

For information about phones that can connect with the watch, visit the CASIO website.

https://world.casio.com/os_mobile/wat/

Copyrights and Registered Copyrights

- The Bluetooth® word mark and logos are registered trademarks owned by the Bluetooth SIG, Inc. and any use of such marks by CASIO Computer Co., Ltd. is under license.
- iPhone and App Store are trademarks of Apple Inc. in the United States and other countries.
- IOS is a trademark or registered trademark of Cisco Systems, Inc.
- Android and Google Play™ are trademarks or registered trademarks of Google LLC.
- Other company names and product names used herein are trademarks or registered trademarks of their respective companies.

Troubleshooting

I can't pair the watch with a phone.

Q1 I've never been able to establish a (pairing) connection between the watch and phone.

Are you using a supported phone model?

Check if the phone model and its operating system are supported by the watch.

For information about supported phone models, visit the CASIO Website.

https://world.casio.com/os_mobile/wat/

Did you install the CASIO WATCHES phone app on your phone?

The CASIO WATCHES phone app needs to be installed on your phone in order to connect with the watch.

🔗 ① [Install the required app on your phone.](#)

Are your phone's Bluetooth settings configured correctly?

Configure the phone's Bluetooth settings. For details about setting procedures, see your phone documentation.

iPhone Users

- "Settings" → "Bluetooth" → On
- "Settings" → "Privacy" → "Bluetooth" → "CASIO WATCHES" → On

Android Users

- Enable Bluetooth.

Is a stopwatch or timer operation being performed?

The watch cannot pair with a phone while a stopwatch time measurement operation is in progress. Stop the measurement operation and then pair with a phone.

Other than the above.

Some phones need to have BT Smart disabled to use the CASIO WATCHES phone app. For details about setting procedures, see your phone documentation.

On the Home Screen, tap: "Menu" → "Settings" → "Bluetooth" → "Menu" → "BT Smart settings" → "Disable".

I can't reconnect the watch and phone.

Q1 The watch will not re-connect with the phone after they are disconnected.

Is the CASIO WATCHES phone app running?

The watch cannot re-connect with your phone unless the CASIO WATCHES app is running on the phone. On your phone's Home Screen, tap the "CASIO WATCHES" icon. Next, on the watch, hold down (B) for at least 2.5 seconds.

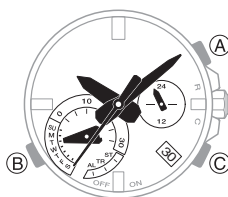

Have you tried turning your phone off and then back on again?

Turn your phone off and back on, and then tap the "CASIO WATCHES" icon. Next, on the watch, hold down (B) for at least 2.5 seconds.

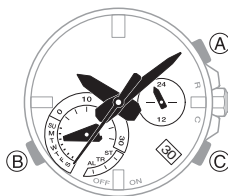

Is the watch's battery charged sufficiently?

Connection with a phone is not possible while the charge is low. Charge the watch and then connect with the phone.

🔗 [Charging](#)

Q2 I can't connect while my phone is in the Airplane Mode.

Connection with the watch is not possible while your phone is in the Airplane Mode. After disabling the phone's Airplane Mode, go to the phone's Home Screen and tap the "CASIO WATCHES" icon. Next, on the watch, hold down (B) for at least 2.5 seconds.

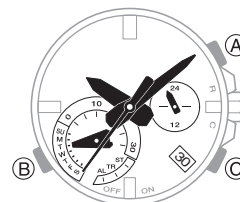

Q3 I changed the phone's Bluetooth from enabled to disabled, and now I can't connect anymore.

On your phone, re-enable Bluetooth, and then go to the Home Screen and tap the "CASIO WATCHES" icon. Next, on the watch, hold down (B) for at least 2.5 seconds.

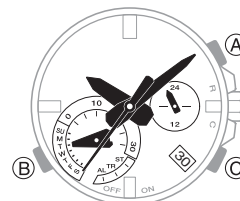

Q4 I can't connect after turning off the phone.

Turn your phone off and back on, and then tap the "CASIO WATCHES" icon. Next, on the watch, hold down (B) for at least 2.5 seconds.

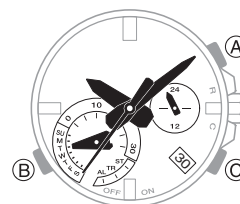

Phone-Watch Connection

Q1 I can't establish a connection between the phone and watch.

Have you tried turning your phone off and then back on again?

Turn your phone off and back on, and then tap the "CASIO WATCHES" icon. Next, on the watch, hold down (B) for at least 2.5 seconds.

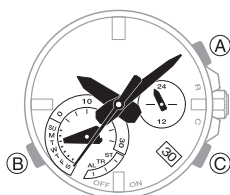

Has the watch been re-paired with the phone?

After deleting the pairing information from the CASIO WATCHES phone app and your phone, re-pair the watch and phone.

🔗 [Deleting Pairing Information from the CASIO WATCHES phone app](#)

🔗 ③ [Pair the watch with a phone.](#)

If you are unable to establish a connection...

After deleting pairing information from the watch, re-pair it with your phone.

🔗 [Deleting Pairing Information from the Watch](#)

🔗 ③ [Pair the watch with a phone.](#)

Changing to a Different Phone Model

Q1 How do I connect my watch to a different phone?

Delete the pairing information from your watch and then pair it with the phone you want to connect with.

🔗 [If you purchase another phone](#)

Auto Time Correction by Bluetooth Connection

Q1 When does the watch correct its time?

Your watch can connect with a paired phone to correct its time setting. The watch will connect with the phone and perform auto time correction at around 12:30 a.m., 6:30 a.m., 12:30 p.m. and 6:30 p.m. The connection is automatically terminated after auto time correction is complete.

Q2 Auto time correction is performed, but the time setting is not correct.

Is auto time correction not being performed according to its normal schedule?

Note that auto time correction is not performed for 24 hours after swapping of the Home Time and World Time, or after the time setting is corrected manually on the watch. Auto time correction will resume 24 hours after either of the above operations is performed.

Is auto time correction enabled?

Auto time correction will not be performed at the scheduled times if it is not enabled. Establish a connection between the watch and phone, and then use the CASIO WATCHES phone app to enable auto time correction.

🔗 [Using the Watch in a Medical Facility or Aircraft](#)

Is the watch's battery charged sufficiently?

Connection with a phone is not possible while the charge is low. Charge the watch.

🔗 [Charging](#)

Q3 Time is not displayed correctly.

If your phone is unable to receive a signal because you are outside its service range or for some other reason, the watch may not be able to display the correct time. If this happens, connect the phone to its network and then correct the time setting.

Alarm

Q1 The alarm does not sound.

Is the watch's battery charged?

Keep the watch exposed to light until it recharges sufficiently.

🔗 [Charging](#)

The crown is pulled out.

The alarm will not sound while the crown is pulled out. Push the crown back in to its normal position.

Is the alarm enabled?

Enable the alarm.

🔗 [Configuring Alarm Settings](#)

Hand Movement and Indications

Q1 I don't know what mode the watch is in.

You can determine the current mode by checking the function hand position. Entering the Stopwatch Mode or Timer Mode causes the function hand to point to the mode name first, and then indicate the current measurement value. You can use (B) to navigate between modes.

🔗 [Navigating Between Modes](#)

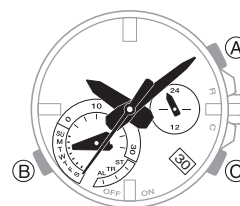

Q2 Why can't I perform any button operations while high-speed hand movement is in progress?

Except for the mode navigation button, button operation is disabled while high-speed hand movement is in progress after a watch setting is changed, etc. Wait until the hands stop moving before performing button operations.

Q3 The second hand is jumping at two-second intervals.

Battery power is low. Keep the watch exposed to light until it recharges sufficiently.

[🔍 Charging](#)

Q4 All hands are stopped at 12 o'clock and buttons do not work.

The battery is dead. Keep the watch exposed to light until it recharges sufficiently.

[🔍 Charging](#)

Q5 The hands suddenly start moving at high speed.

This is due to the reason (or one of the reasons) below, and does not indicate malfunction. Simply wait until normal hand movement resumes.

- The watch is recovering from a power saving state.
[🔍 Power Saving](#)
- Watch is connected with a phone to correct its time setting.
[🔍 Auto Time Correction](#)

Q6 Hands are stopped and buttons do not work.

The watch is in the charge recovery mode. Wait until the recovery process is complete (for about 15 minutes). The watch will recover more quickly if you place it in a brightly lit location.

Q7 The hand and/or day indicator are not aligned correctly.

Strong magnetism or impact can cause the hands and/or the indicator to go out of alignment. Correct hand and/or day indicator alignment.

[🔍 Correcting Hand and Day Indicator Alignment](#)

- Check the information below to find out how to align the hands and/or day indicator manually.
[🔍 Hand and Day Indicator Alignment](#)

Q8 The time setting is correct, but the day indicator is between days.

Is the date setting being updated?

For information about how the day changes, see the section below.

[🔍 Hand and Day Indicator Movement](#)

Other than the above.

The day indicator is not aligned correctly. Correct day indicator alignment.

[🔍 Correcting Hand and Day Indicator Alignment](#)

- Check the information below to find out how to align the hands and/or day indicator manually.

[🔍 Hand and Day Indicator Alignment](#)

Crown Operations

Q1 Nothing happens when I rotate the crown.

If you do not perform any operation for about two minutes after pulling out the crown (approximately 30 minutes in the case of hand and day indicator alignment), crown operations will automatically become disabled. Push the crown back in to its normal position and then pull it out again to re-enable crown operations.

[🔍 Using the Crown](#)

Q2 Crown operation does not work.

Crown operation is disabled while high-speed hand movement is in progress after a watch setting is changed, etc. Wait until the hands stop moving before performing crown operations.

Charging

Q1 The watch does not work even though it is exposed to light.

The watch stops operating whenever the battery goes dead. Keep the watch exposed to light until it recharges sufficiently.

[🔍 Charging](#)

Other

Q1 I can't find the information I need here.

Visit the website below.

<https://world.casio.com/support/>

Precautions

Operating Precautions

● Water Resistance

- The information below applies to watches with WATER RESIST or WATER RESISTANT marked on the back cover.

Water Resistance Under Daily Use

Marking on watch front or on back cover	No BAR mark
---	-------------

Example of Daily Use

Hand washing, rain	Yes
Water-related work, swimming	No
Windsurfing	No
Skin diving	No

Enhanced Water Resistance Under Daily Use

5 Atmospheres

Marking on watch front or on back cover	5BAR
---	------

Example of Daily Use

Hand washing, rain	Yes
Water-related work, swimming	Yes
Windsurfing	No
Skin diving	No

10 Atmospheres

Marking on watch front or on back cover	10BAR
---	-------

Example of Daily Use

Hand washing, rain	Yes
Water-related work, swimming	Yes
Windsurfing	Yes
Skin diving	Yes

20 Atmospheres

Marking on watch front or on back cover	20BAR
---	-------

Example of Daily Use

Hand washing, rain	Yes
Water-related work, swimming	Yes
Windsurfing	Yes
Skin diving	Yes

- Do not use your watch for scuba diving or other types of diving that requires air tanks.

- Watches that do not have WATER RESIST or WATER RESISTANT marked on the back cover are not protected against the effects of sweat. Avoid using such a watch under conditions where it will be exposed to large amounts of sweat or moisture, or to direct splashing with water.

- Even if a watch is water resistant, note the usage precautions described below. Such types of use reduce water resistance performance and can cause fogging of the glass.
 - Do not operate the crown or buttons while your watch is submersed in water or wet.
 - Avoid wearing your watch while in the bath.
 - Do not wear your watch while in a heated swimming pool, sauna, or any other high temperature/high humidity environment.
 - Do not wear your watch while washing your hands or face, while doing housework, or while performing any other task that involves soaps or detergents.

- After submersion in seawater, use plain water to rinse all salt and dirt from your watch.
- To maintain water resistance, have the gaskets of your watch replaced periodically (about once every two or three years).
- A trained technician will inspect your watch for proper water resistance whenever you have its battery replaced. Battery replacement requires the use of special tools. Always request battery replacement from your original retailer or from an authorized CASIO service center.
- Some water-resistant watches come with fashionable leather bands. Avoid swimming, washing, or any other activity that causes direct exposure of a leather band to water.

- The inside surface of the watch glass may fog when the watch is exposed to a sudden drop in temperature. No problem is indicated if the fogging clears up relatively quickly. Sudden and extreme temperature changes (such as coming into an air conditioned room in the summer and standing close to an air conditioner outlet, or leaving a heated room in the winter and allowing your watch to come into contact with snow) can cause it to take longer for glass fogging to clear up. If glass fogging does not clear up or if you notice moisture inside of the glass, immediately stop using your watch and take it to your original retailer or to an authorized CASIO service center.

- Your water-resistant watch has been tested in accordance with International Organization for Standardization regulations.

● Band

- Tightening the band too tightly can cause you to sweat and make it difficult for air to pass under the band, which can lead to skin irritation. Do not fasten the band too tightly. There should be enough room between the band and your wrist so you can insert your finger.

- Deterioration, rust, and other conditions can cause the band to break or come off of your watch, which in turn can cause band pins to fly out of position or to fall out. This creates the risk of your watch falling from your wrist and becoming lost, and also creates the risk of personal injury. Always take good care of your band and keep it clean.

- Immediately stop using a band if you even notice any of the following: loss of band flexibility, band cracks, band discoloration, band looseness, band connecting pin flying or falling out, or any other abnormality. Take your watch to your original retailer or to a CASIO service center for inspection and repair (for which you will be charged) or to have the band replaced (for which you will be charged).

● Temperature

- Never leave your watch on the dashboard of a car, near a heater, or in any other location that is subject to very high temperatures. Do not leave your watch where it will be exposed to very low temperatures. Temperature extremes can cause your watch to lose or gain time, to stop, or otherwise malfunction.

● Impact

- Your watch is designed to withstand impact incurred during normal daily use and during light activity such as playing catch, tennis, etc. Dropping your watch or otherwise subjecting it to strong impact, however, can lead to malfunction. Note that watches with shock-resistant designs (G-SHOCK, BABY-G, G-MS) can be worn while operating a chain saw or engaging in other activities that generate strong vibration, or while engaging in strenuous sports activities (motocross, etc.)

● Magnetism

- The hands of analog and combination (analog-digital) watches are moved by a motor that uses magnetic force. When such a watch is close to a device (audio speakers, magnetic necklace, cell phone, etc.) that emits strong magnetism, the magnetism can cause timekeeping to slow down, speed up, or stop, resulting in the incorrect time being displayed.
- Very strong magnetism (from medical equipment, etc.) should be avoided because it can cause malfunction of your watch and damage to electronic components.

● Electrostatic Charge

- Exposure to very strong electrostatic charge can cause your watch to display the wrong time. Very strong electrostatic charge even can damage electronic components.

● Chemicals

- Do not allow your watch to come into contact with thinner, gasoline, solvents, oils, or fats, or with any cleaners, adhesives, paints, medicines, or cosmetics that contain such ingredients. Doing so can cause discoloration of or damage to the resin case, resin band, leather, and other parts.

● Storage

- If you do not plan to use your watch for a long time, thoroughly wipe it free of all dirt, sweat, and moisture, and store it in a cool, dry place.

● Resin Components

- Allowing your watch to remain in contact with other items or storing it together with other items for long periods while it is wet can cause color on resin components to transfer to the other items, or the color of the other items to transfer to the resin components of your watch. Be sure to dry off your watch thoroughly before storing it and make sure it is not in contact with other items.
- Leaving your watch where it is exposed to direct sunlight (ultraviolet rays) for long periods or failure to clean dirt from your watch for long periods can cause it to become discolored.
- Friction caused by certain conditions (strong external force, sustained rubbing, impact, etc.) can cause discoloration of painted components.
- If there are printed figures on the band, strong rubbing of the printed area can cause discoloration.
- Leaving your watch wet for long periods can cause fluorescent color to fade. Wipe the watch dry as soon as possible after it becomes wet.
- Semi-transparent resin parts can become discolored due to sweat and dirt, and if exposed to high temperatures and humidity for long periods.
- Daily use and long-term storage of your watch can lead to deterioration, breaking, or bending of resin components. The extent of such damage depends on usage conditions and storage conditions.

● Leather Band

- Allowing your watch to remain in contact with other items or storing it together with other items for long periods while it is wet can cause the color of the leather band to transfer to the other items or the color of the other items to transfer to the leather band. Be sure to dry off your watch thoroughly with a soft cloth before storing it and make sure it is not in contact with other items.

- Leaving a leather band where it is exposed to direct sunlight (ultraviolet rays) for long periods or failure to clean dirt from a leather band for long periods can cause it to become discolored.

CAUTION:

Exposing a leather band to rubbing or dirt can cause color transfer and discoloration.

● Metal Components

- Failure to clean dirt from metal components can lead to formation of rust, even if components are stainless steel or plated. If metal components exposed to sweat or water, wipe thoroughly with a soft, absorbent cloth and then place the watch in a well-ventilated location to dry.
- Use a soft toothbrush or similar tool to scrub the metal with a weak solution of water and a mild neutral detergent, or with soapy water. Next, rinse with water to remove all remaining detergent and then wipe dry with a soft absorbent cloth. When washing metal components, wrap the watch case with kitchen plastic wrap so it does not come into contact with the detergent or soap.

● Bacteria and Odor Resistant Band

- The bacteria and odor resistant band protects against odor generated by the formation of bacteria from sweat, which ensures comfort and hygiene. In order to ensure maximum bacteria and odor resistance, keep the band clean. Use an absorbent soft cloth to thoroughly wipe the band clean of dirt, sweat, and moisture. A bacteria and odor resistant band suppresses the formation of organisms and bacteria. It does not protect against rash due to allergic reaction, etc.

Note that CASIO Computer Co., Ltd. assumes no responsibility for any damage or loss suffered by you or any third party arising through the use of your watch or its malfunction.

User Maintenance

● Caring for Your Watch

Remember that you wear your watch next to your skin, just like a piece of clothing. To ensure your watch performs at the level for which it is designed, keep it clean by frequently wiping with a soft cloth to keep your watch and band free of dirt, sweat, water and other foreign matter.

- Whenever your watch is exposed to sea water or mud, rinse it off with clean fresh water.
- For a metal band or a resin band with metal parts, use a soft toothbrush or similar tool to scrub the band with a weak solution of water and a mild neutral detergent, or with soapy water. Next, rinse with water to remove all remaining detergent and then wipe dry with a soft absorbent cloth. When washing the band, wrap the watch case with kitchen plastic wrap so it does not come into contact with the detergent or soap.
- For a resin band, wash with water and then wipe dry with a soft cloth. Note that sometimes a smudge like pattern may appear on the surface of a resin band. This will not have any effect on your skin or clothing. Wipe with a cloth to remove the smudge pattern.
- Clean water and sweat from a leather band by wiping with a soft cloth.
- Not operating a watch crown, buttons, or rotary bezel could lead to later problems with their operation. Periodically rotate the crown and rotary bezel, and press buttons to maintain proper operation.

● Dangers of Poor Watch Care

Rust

- Though the metal steel used for your watch is highly rust-resistant, rust can form if your watch is not cleaned after it becomes dirty.
 - Dirt on your watch can make it impossible for oxygen to come into contact with the metal, which can lead to breakdown of the oxidization layer on the metal surface and the formation of rust.
- Rust can cause sharp areas on metal components and can cause band pins to fly out of position or to fall out. If you ever notice any abnormality immediately stop using your watch and take it to your original retailer or to an authorized CASIO service center.
- Even if the surface of the metal appears clean, sweat and rust in crevasses can soil the sleeves of clothing, cause skin irritation, and even interfere with watch performance.

Premature Wear

- Leaving sweat or water on a resin band or bezel, or storing your watch an area subject to high moisture can lead to premature wear, cuts, and breaks.

Skin Irritation

- Individuals with sensitive skin or in poor physical condition may experience skin irritation when wearing a watch. Such individuals should keep their leather band or resin band particularly clean. Should you ever experience a rash or other skin irritation, immediately remove your watch and contact a skin care professional.

Battery

- The special rechargeable battery used by your watch is not intended to be removed or replaced by you. Use of a rechargeable battery other than the special one specified for your watch can damage your watch.
- The rechargeable (secondary) battery is charged when the solar panel is exposed to light, so it does not require regular replacement as the primary battery requires. Note, however, that long use or operating conditions can cause the capacity or charging efficiency of the rechargeable battery to deteriorate. If you feel that the amount of operation provided by charging is too short, contact your original retailer or CASIO service center.

Mobile Link Precautions

● Legal Precautions

- This watch complies with or has received approval under the radio laws of various countries and geographical areas. Using this watch in an area where it does not comply with or has not received approval under applicable radio laws may be a criminal offense. For details, visit the CASIO Website.

<https://world.casio.com/ce/BLE/>

- Use of this watch inside of aircraft is restricted under the aviation laws of each country. Be sure to follow the instructions of airline personnel.

● Precautions when using Mobile Link

- When using this watch in combination with a phone, keep the watch and phone close to each other. A range of two meters is recommended as a guideline, but the local environment (walls, furniture, etc.), the structure of a building, and other factors may require a much closer range.
- This watch can be affected by other devices (electrical devices, audio-visual equipment, office equipment, etc.) In particular, it can be affected by operation of a microwave oven. The watch may not be able to communicate normally with a phone if a microwave oven is operating nearby. Conversely, this watch may cause noise in radio reception and the video image of a TV.
- Bluetooth of this watch uses the same frequency band (2.4 GHz) as wireless LAN devices, and use of such devices in close proximity of this watch may result in radio interference, slower communication speeds and noise for the watch and the wireless LAN device, or even communication failure.

● Stopping Radio Wave Emission by This Watch

The watch is emitting radio waves whenever the second hand is pointing to [C] (Bluetooth connected) or [R] (Bluetooth connection standby).

Even if the second hand is not pointing at [C] or [R], the watch will automatically attempt to connect with a phone four times a day to correct its time settings.

When in a hospital, on an aircraft, or in any other area where the use of radio waves is not allowed, use the operation below to stop radio wave generation.

- Stopping Radio Wave Generation
Press any button to terminate the Bluetooth connection.

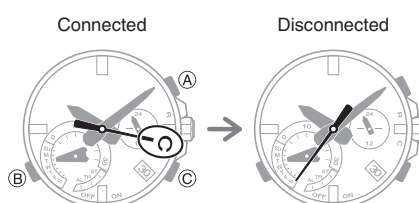

- Disabling Auto Time Correction
Configure CASIO WATCHES phone app settings to disable synchronization between the watch and phone.
[Using the Watch in a Medical Facility or Aircraft](#)