



PARTS LIST / TECHNICAL GUIDE

Automatic Cal.4R71A

[SPECIFICATION]

Item		Cal. No.	4R71A		
					
<ul style="list-style-type: none"> •3 Hands (Hour, Minute and Second hands) 		<ul style="list-style-type: none"> •Movement Size •Diameter •Height 		<ul style="list-style-type: none"> Outside : $\phi 27.4$ mm Casing : $\phi 27.0$ mm : 5.32 mm 	
Driving system		Automatic winding with manual winding mechanism			
Additional function		•Second hand stop function			
Crown operation	Normal position	Manual winding (clockwise only)			
	1st click	Time setting / Second hand stop function			
Vibration per hour		21,600 (6 beats per second)			
Loss/Gain	Daily Rate	Between +45 and -35 seconds per day (worn on the wrist at temperature range between 5°C and 35°C)			
	Standard rate for measurement	Testing positions	Instantaneous rate at T0 (Fully wound condition)		Isochronous fault
		Measurement (Daily rate in seconds :s/d)	Dial upward	6 o'clock at the top	9 o'clock at the top
Regulation system		ETACHRON system			
Lift angle of the escapement		53°			
Continuous operating time		From fully wound to stoppage: Approximately 41 hours			
Number of Jewels		24 Jewels			

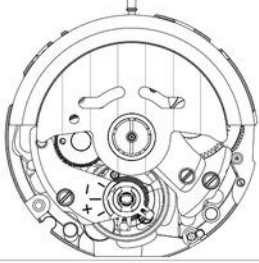
SEIKO WATCH CORPORATION

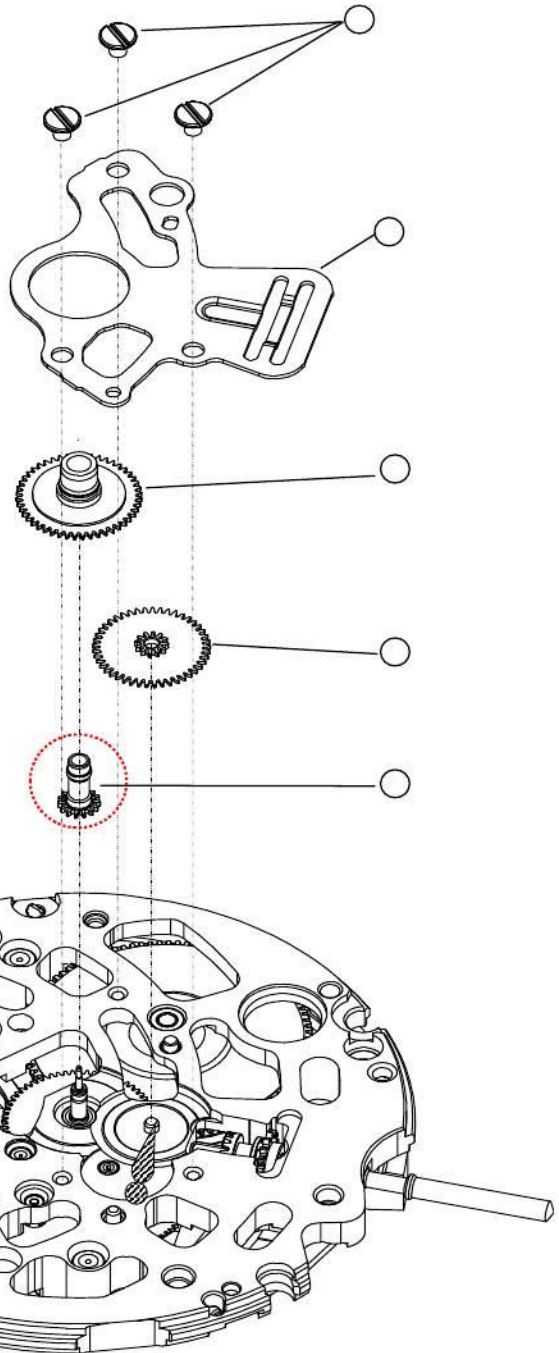
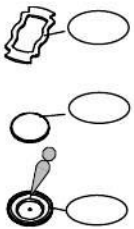
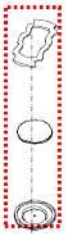
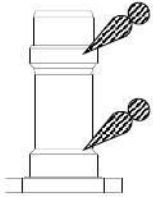
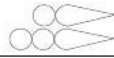

SEIKO WATCH CORPORATION

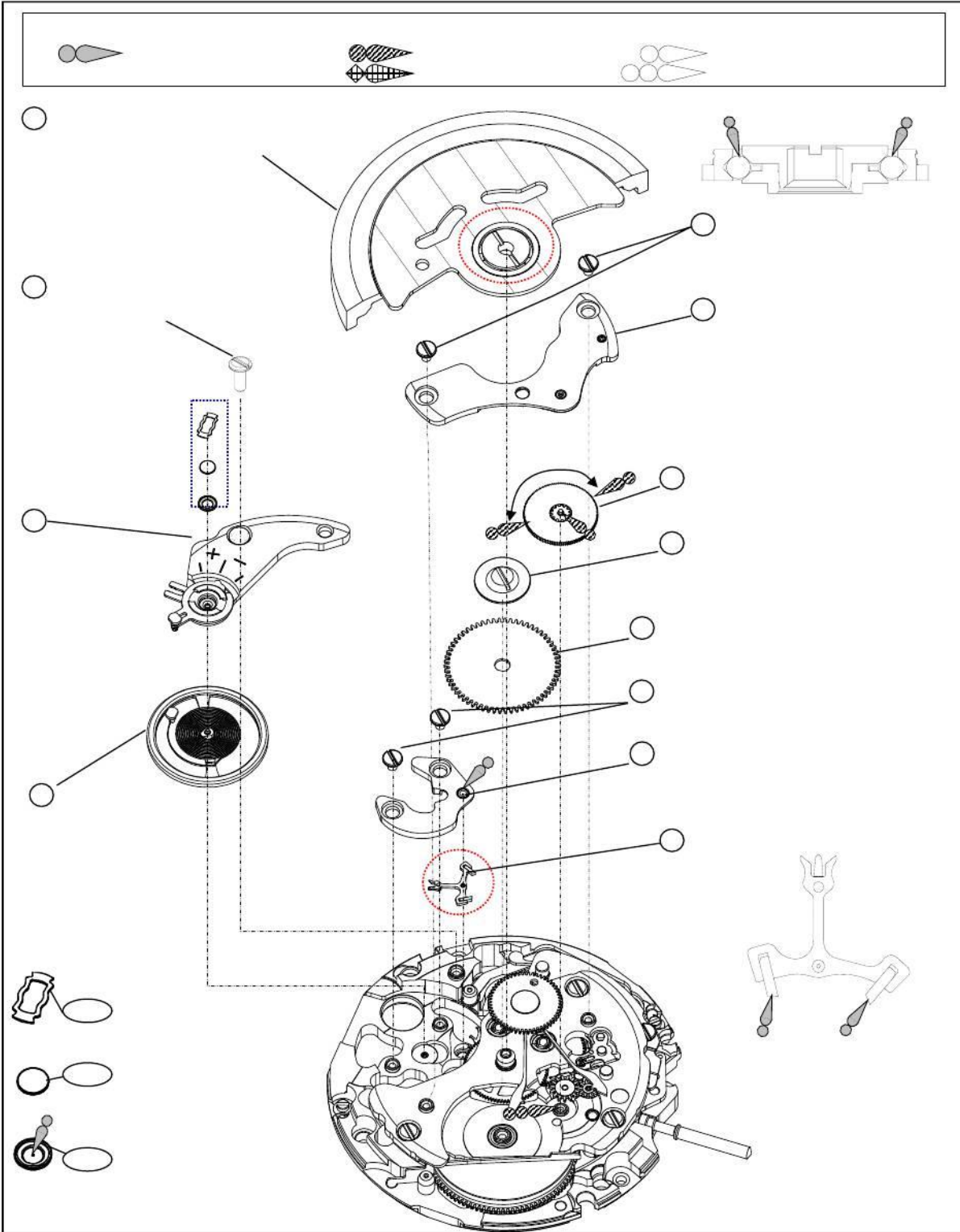

SEIKO WATCH CORPORATION

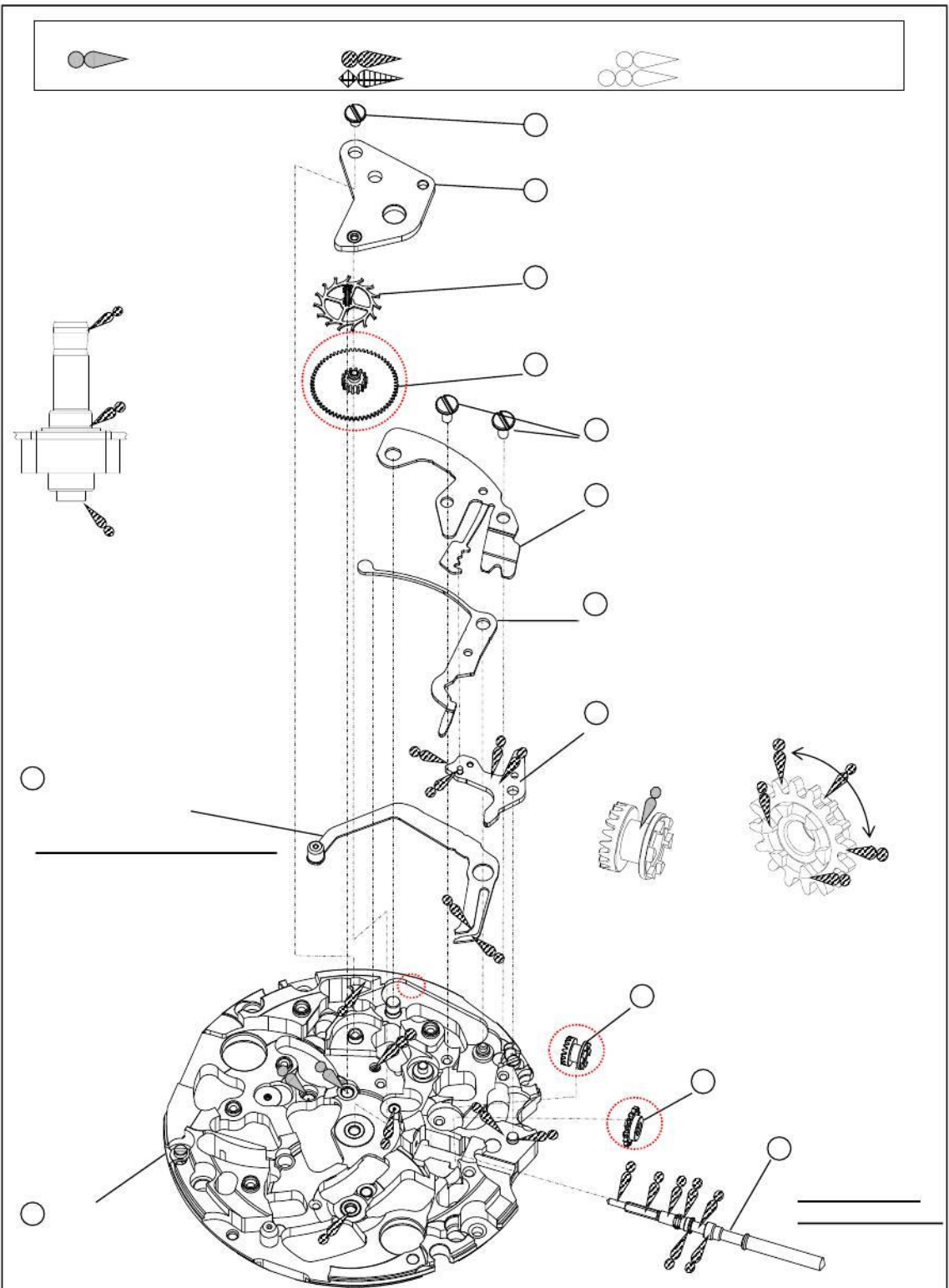

SEIKO WATCH CORPORATION

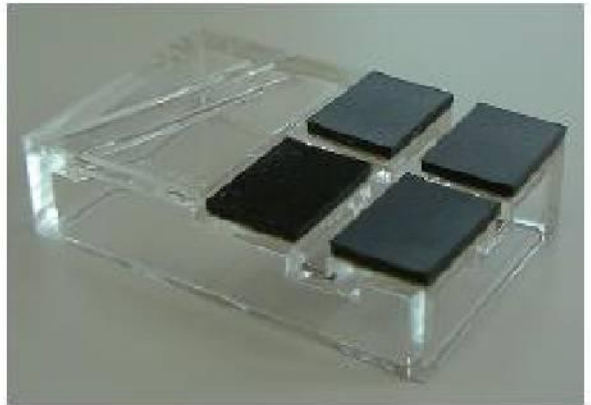

SEIKO WATCH CORPORATION

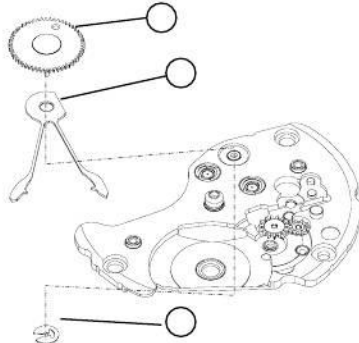
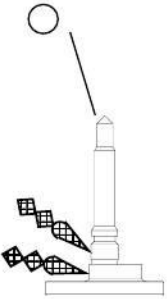
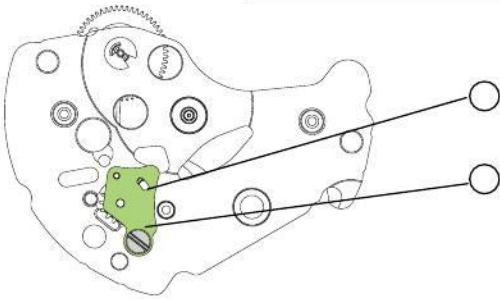
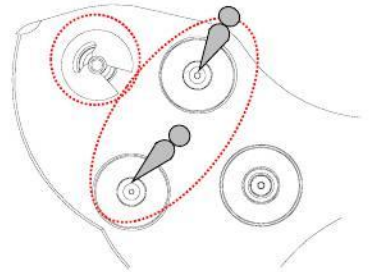
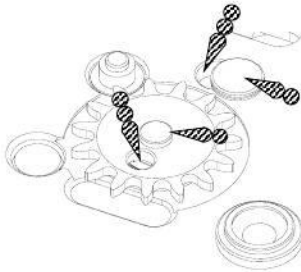
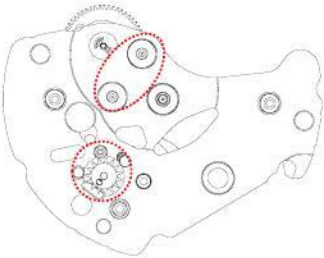
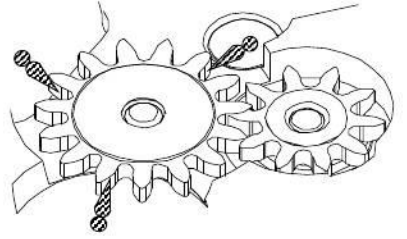
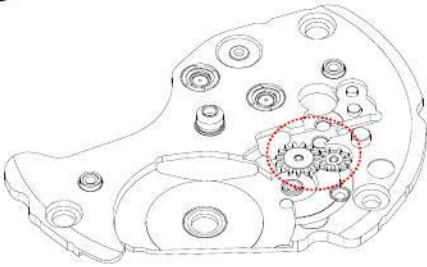

SEIKO WATCH CORPORATION

○

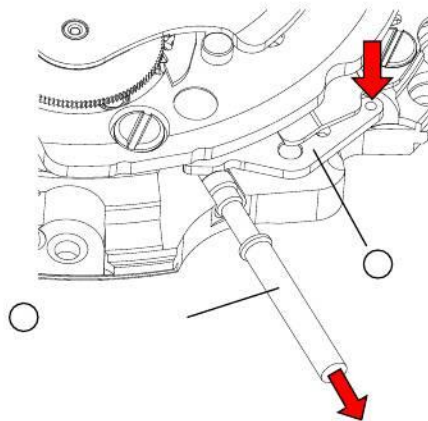
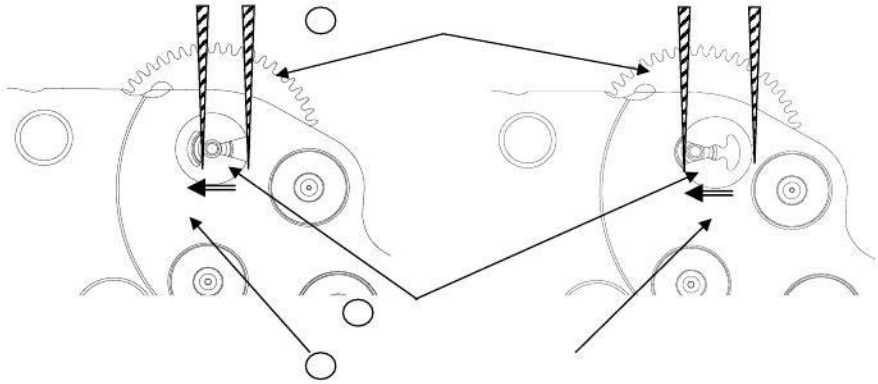
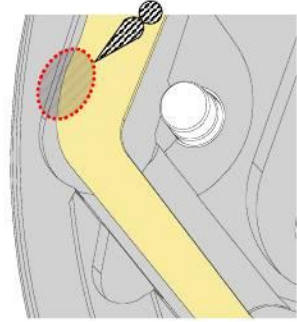
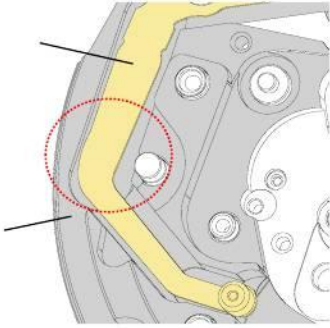

SEIKO WATCH CORPORATION

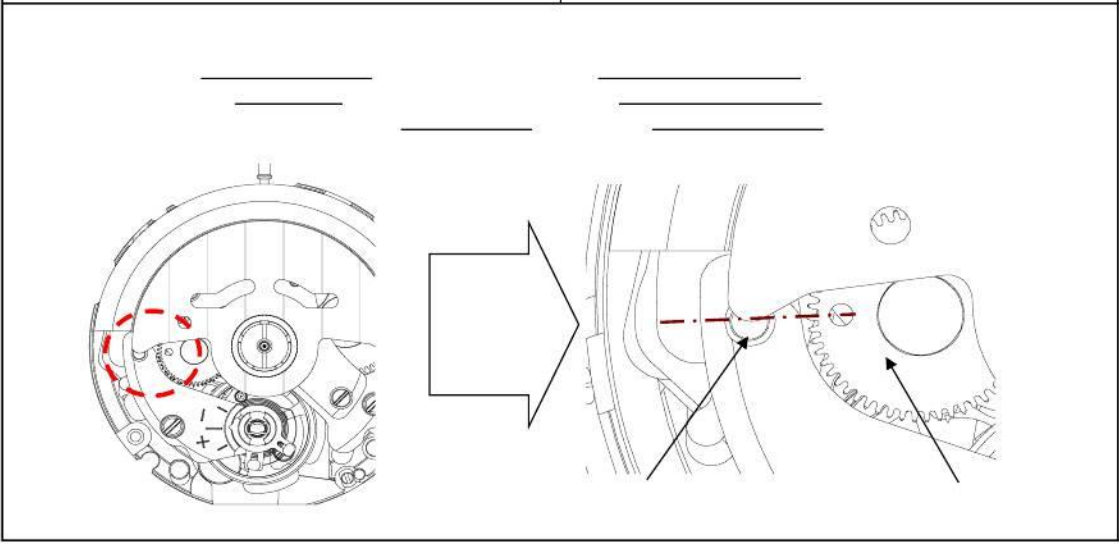
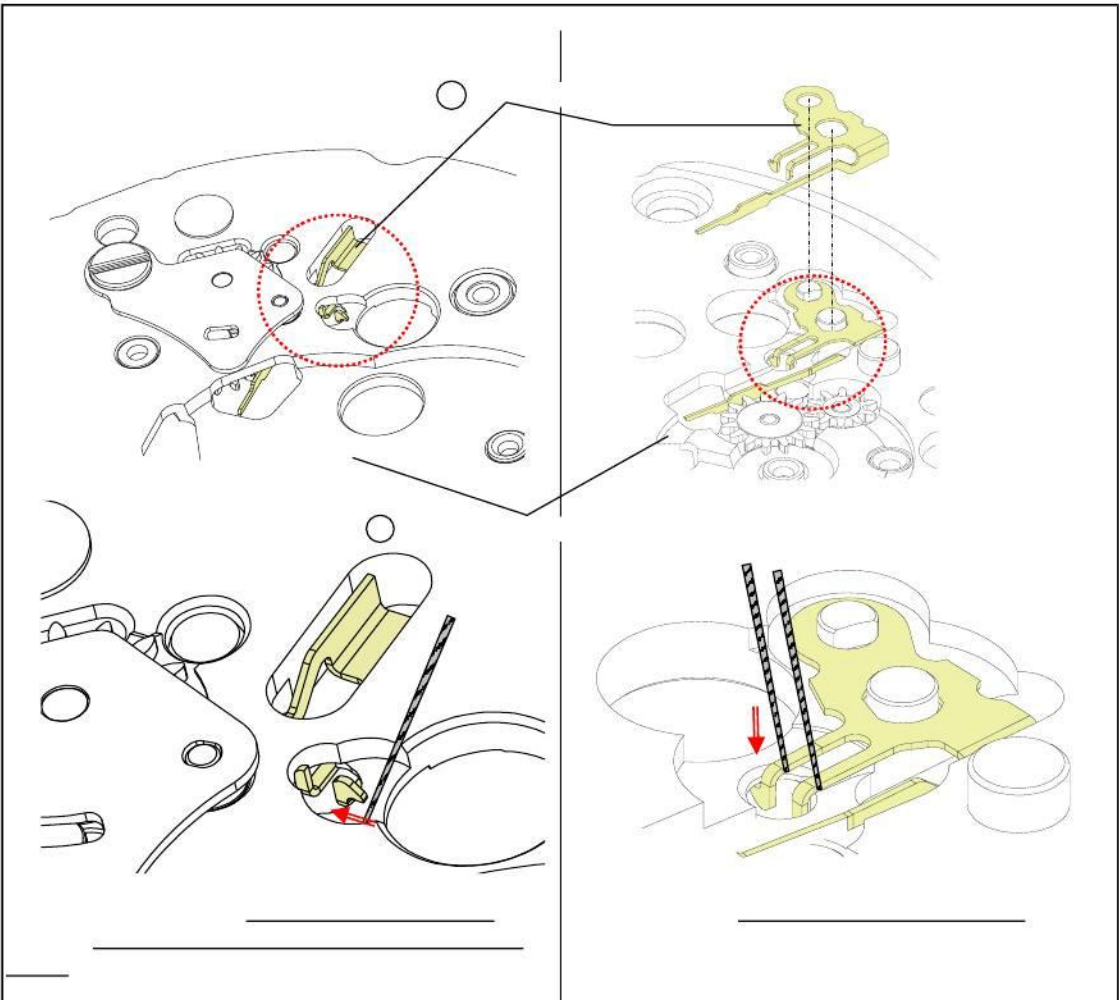

SEIKO WATCH CORPORATION

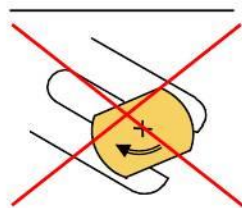
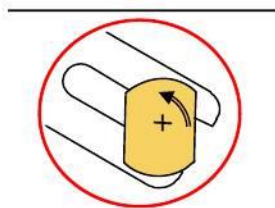
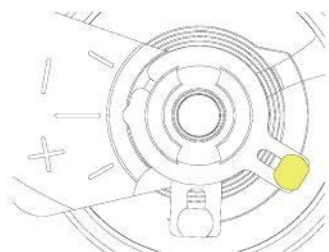
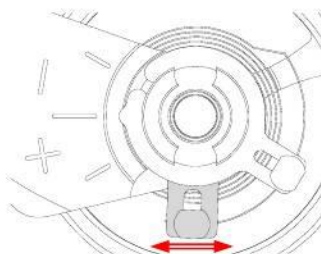
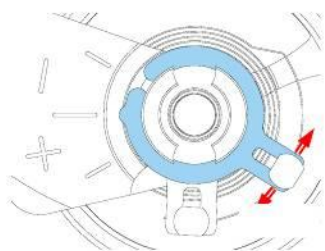
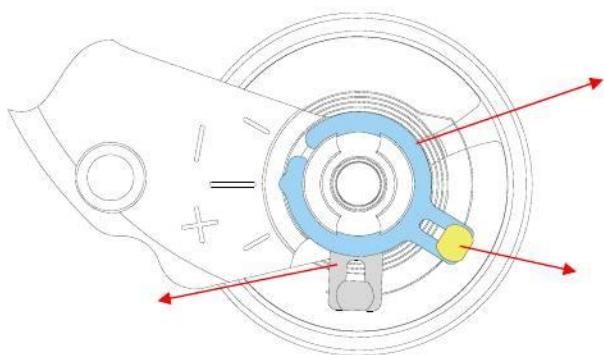

SEIKO WATCH CORPORATION

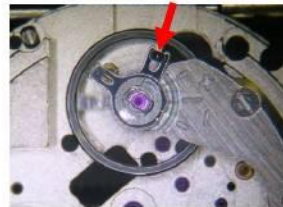
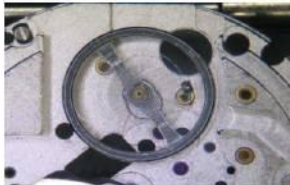
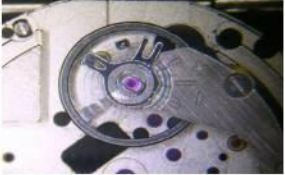
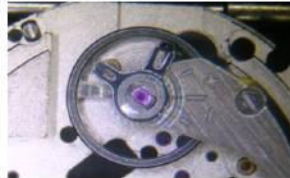
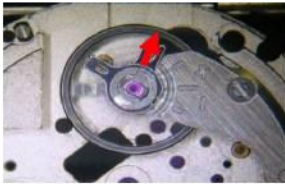
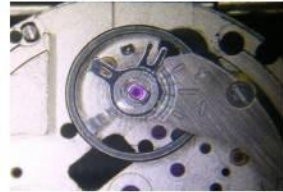
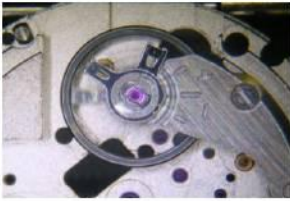
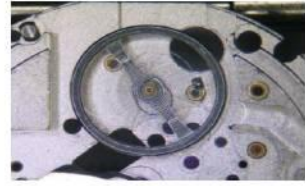
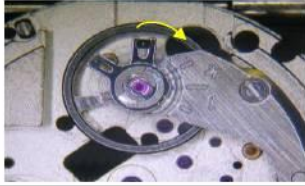

SEIKO WATCH CORPORATION

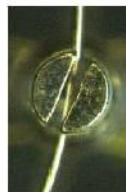
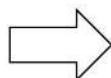
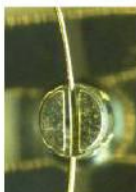
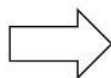
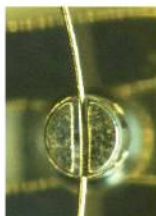
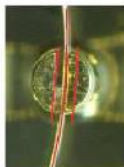

SEIKO WATCH CORPORATION

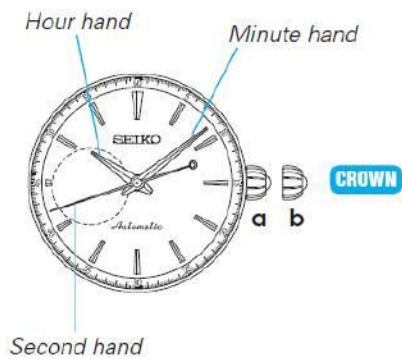

SEIKO WATCH CORPORATION

	<input type="text"/>	
	<input type="text"/>	
	<input type="text"/>	
	<input type="text"/>	
	<input type="text"/>	
	<input type="text"/>	

SEIKO WATCH CORPORATION