

Watch Operation Guide 5746

CASIO®

Contents

About This Watch

General Guide

Watch Face and Display Indicators

Navigating Between Modes

Cycling Between Timekeeping Mode Digital Display Contents

Shifting Hands to Read the Digital Display

Charging

Viewing the Face in the Dark

Useful Features

Linking with a Phone

Getting Ready

Auto Time Correction

Viewing Stopwatch Data

Configuring World Time Settings

Adjusting Hand Alignment

Phone Finder

Configuring Watch Settings

Changing the Home City Summer Time Setting

Checking the Watch Charge Level

Recording Your Current Location (TIME&PLACE)

Connection

- Connecting with a Phone
- Disconnecting from Your Phone
- Unpairing
- If you purchase another phone

Time Adjustment

Using Watch Operations to Adjust the Time Setting

Using the Watch in a Medical Facility or Aircraft

World Time

Using CASIO WATCHES to Configure World Time City Settings

Checking World Time

World Time City Setting

Swapping Your Home Time and World Time

Moving to Another Time Zone

Alarm

Using CASIO WATCHES to Configure Alarm Settings

Configuring Alarm Settings

Enabling the Hourly Time Signal

Turning Off an Alarm or the Hourly Time Signal

Alarm Countdown Indication

Stopwatch

Split Times and Lap Times

Measuring Elapsed Time

Measuring a Split Time

Measuring Lap Times

Timer

Using CASIO WATCHES to Configure Timer Settings

Setting the Countdown Start Time

Using the Timer

Timer Countdown Indication

Hand Alignment Adjustment

Using CASIO WATCHES to Adjust Hand Alignment

Adjusting Hand Alignment

Other Settings

Specifying the Day of the Week Language

Disabling the Countdown Start Tone

Enabling the Button Operation Tone

Configuring Power Saving Function Settings

Resetting Watch Settings

Specifications

Other Information

City Table

Summer Time Table

Supported Phones

Copyrights and Registered Copyrights

Troubleshooting

Precautions

Operating Precautions

User Maintenance

Battery

Mobile Link Precautions

About This Watch

This section provides an overview of the watch and introduces convenient ways it can be used.

Watch Features

• Phone Linking

The watch supports connection and communication with a Bluetooth capable phone.

• World Time

Display the current time in any one of 38 time zones* around the globe.

* Subject to being updated when connected with a phone.

• Alarm

An alarm sounds whenever a time specified by you is reached.

• Stopwatch

The stopwatch measures elapsed time in units of 1/100 second for the first hour, and in one-second units thereafter, for up to 24 hours.

• Timer

Countdown from a start time specified by you. An alarm sounds when the countdown reaches zero.

Note

- The illustrations included in this operation guide have been created to facilitate explanation. An illustration may differ somewhat from the item it represents.

General Guide

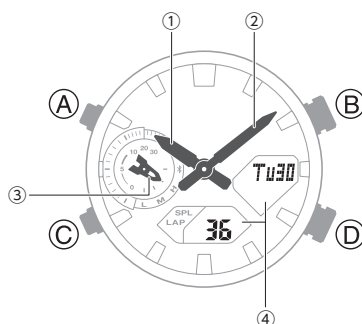

- ① Hour hand
- ② Minute hand
- ③ Function hand
Indicates the current charge level.
Shows the remaining time when there are 30 minutes or less remaining before an alarm time or the end of a timer countdown.

④ LCD

A button

Pressing this button in the Timekeeping Mode cycles between displays.

B button

Press to turn on illumination.

C button

Each press cycles between watch modes. In any mode, hold down this button for at least one second to return to the Timekeeping Mode.

D button

Pressing this button while any setting screen is displayed changes the setting.

Watch Face and Display Indicators

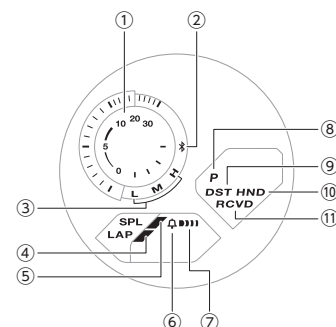

- ① Countdown indicator
Shows the remaining time when there are 30 minutes or less remaining before an alarm time or the end of a timer countdown.
- ② The function hand points to P while the watch is connected with a phone.
- ③ Battery level
The function hand indicates the current charge level.
- ④ Displayed while a Stopwatch Mode lap measurement operation is in progress.
- ⑤ Displayed while a Stopwatch Mode split time measurement operation is in progress.
- ⑥ Displayed while the hourly time signal is enabled.
- ⑦ Displayed while an alarm is turned on.
- ⑧ Displayed during p.m. times while 12-hour timekeeping is being used.
- ⑨ Displayed while the watch is indicating summer time.
- ⑩ Flashes while the watch's hands are shifted for easier reading.
- ⑪ Displayed when the watch successfully connects with a phone and adjusts its time setting.

Navigating Between Modes

Each press of (C) cycles between watch modes.

- In any mode, hold down (C) for at least one second to return to the Timekeeping Mode.

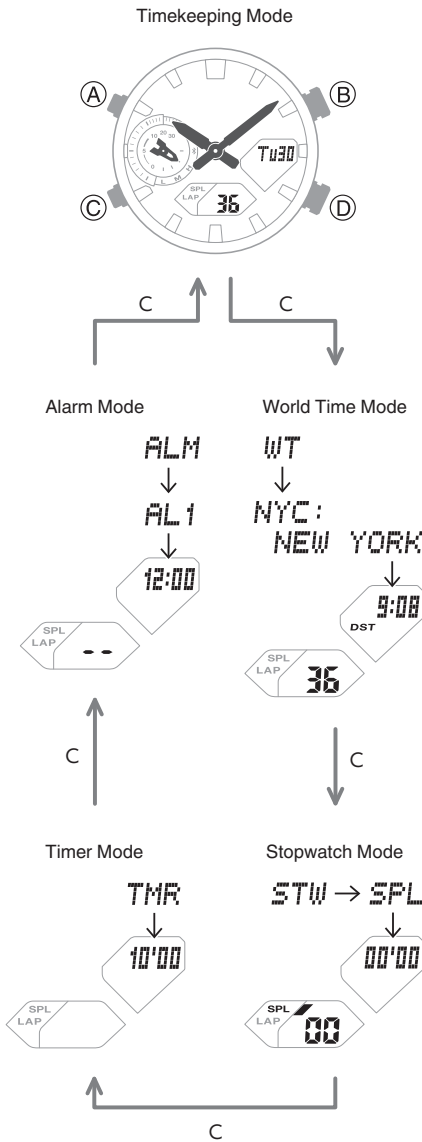

Connecting with a Phone

Hold down (C) for at least three seconds to connect with a phone.

- To disconnect, press any button.

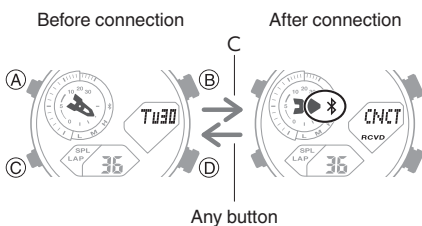

Cycling Between Timekeeping Mode Digital Display Contents

Each press of (A) in the Timekeeping Mode toggles between the display information as shown below.

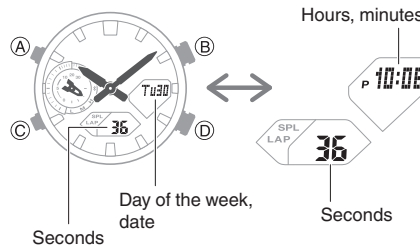

Shifting Hands to Read the Digital Display

Hand shift moves the hands out of the way for easy viewing of display information.

1. While holding down (B), press (C).
 - This shifts the analog hands to allow easy viewing of display information.

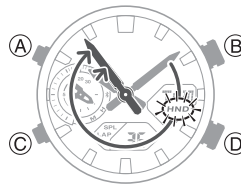

2. To return the hands to their normal timekeeping positions, hold down (B) as you press (C) again, or press (C) to change to another mode.

Note

- If you leave the watch with its hands shifted and do not perform any operation for about one hour, the hands resume normal timekeeping automatically.

Charging

This watch runs on power supplied from a rechargeable (secondary) battery that is charged by a solar panel. The solar panel is integrated into the face of the watch, and power is generated whenever the face is exposed to light.

Charging the Watch

When you are not wearing the watch, put it in a location where it is exposed to bright light.

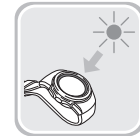

While you are wearing the watch, make sure that its face (solar panel) is not blocked from light by the sleeve of your clothing. Power generation efficiency is reduced even when the face of the watch is blocked only partially.

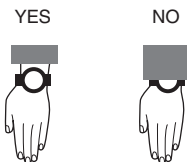

Important!

- Some light sources and environments can cause the watch to become extremely hot during charging, which creates the risk of burn injury and damage to internal watch components. Avoid charging the watch under conditions like the ones described below, where the temperatures may exceed 60 °C (140 °F).
 - On the dashboard of a vehicle parked in the sun
 - Near incandescent lamps, camera lights, halogen lamps, or other sources of heat
 - In locations exposed to direct sunlight for long periods and other hot locations

● Checking the Charge Level

In the Timekeeping Mode, the function hand indicates the current charge level.

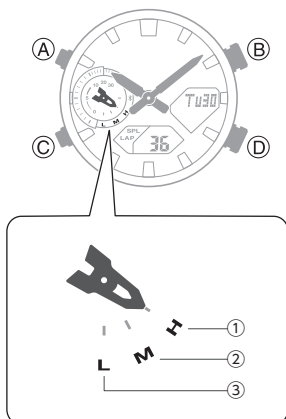

- ① Good (high charge)
- ② Good (medium charge)
- ③ Low Battery

● Low Battery

A low battery will cause [LOW] to flash and will disable the functions below.

- Illumination
- Sounds (alarm, etc.)
- Connection with a phone



If the charge level drops even further, [CHG] will flash and the hour and minute hands will stop at 12 o'clock. If this happens, all functions are disabled.



● Dead Battery

The digital display goes blank if the battery goes dead. Memory data is lost, and watch settings are returned to their initial factory defaults.

Important!

- Should the battery go low or go dead, expose the face (solar panel) to light as soon as possible.
- Exposing the watch to light while its battery is dead causes [CHG] to start flashing. Expose the watch to light to charge it until the Timekeeping Mode screen re-appears.

Note

- If [R] is flashing, it means that all functions, except for timekeeping, are disabled due to high momentary battery power consumption.
Hands are stopped and buttons do not work.

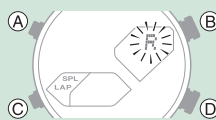

● Charging Time Guidelines

The table below shows guidelines for approximate charging times.

Charging Times Required for 1 Day of Operation

Light Level (Lux)	Approximate Charging Time
50,000	8 minutes
10,000	30 minutes
5,000	48 minutes
500	8 hours

Charge Recovery Times

- Sunny day, outdoors (50,000 lux)

Dead battery → Medium charge	3 hours
Medium charge → High charge	23 hours
High charge → Full charge	7 hours

- Sunny day, near a window (10,000 lux)

Dead battery → Medium charge	7 hours
Medium charge → High charge	88 hours
High charge → Full charge	24 hours

- Overcast day, near a window (5,000 lux)

Dead battery → Medium charge	11 hours
Medium charge → High charge	142 hours
High charge → Full charge	38 hours

- Indoor fluorescent lighting (500 lux)

Dead battery → Medium charge	140 hours
Medium charge → High charge	-
High charge → Full charge	-

Note

- Actual charging time depends on the charging environment, watch settings, and other factors.

● Power Saving Function

Leaving the watch in a dark location for about one hour between the hours of 10 p.m. and 6 a.m. will cause the display to go blank, and the watch to enter Level 1 power saving. If the watch is left in this condition for six or seven days, the watch will enter Level 2 power saving.

Power Saving Level 1 :

Digital display goes blank to save power. The watch can connect with a phone at this level.

Power Saving Level 2 :

All hands stop and the digital display goes blank to save power. All functions are disabled.

Recovering from Power Saving Operation

Use one of the operations below to exit power saving.

- Press any button.
- Move the watch to a bright location.

Note

- You can enable or disable Power Saving.
 - 🔗 [Configuring Power Saving Function Settings](#)
- Note that the watch also may enter power saving if its face is blocked from light by your sleeve while you are wearing it.

Viewing the Face in the Dark

The watch has an LED light that you can turn on for reading in the dark.

● Turning On Illumination

Press (B) to illuminate the face and digital display.



- Illumination turns off automatically if an alarm starts to sound.
- Illumination is disabled while the hands are moving at high speed.
- The light may flicker when it turns on or off.

● Specifying the Illumination Duration

You can select either 1.5 seconds or three seconds as the illumination duration.

1. Enter the Timekeeping Mode.
 - 🔗 [Navigating Between Modes](#)
2. Hold down (A) for at least two seconds until the name of the currently selected Home City is displayed.
 - This is the setting mode. The hands automatically shift out of the way for easy viewing of the display and other indicators.

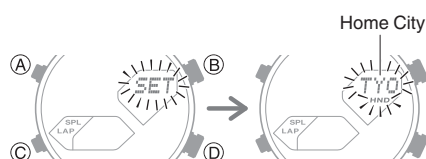

3. Press (C) 12 times to display [LIGHT].

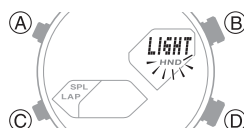

4. Press (D) to select an illumination duration.

[LT1]: 1.5-second light

[LT3]: 3-second light

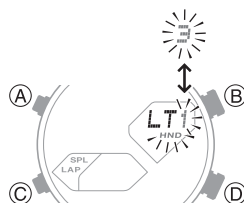

5. Press (A) to exit the setting screen.

Note

- While the setting is being configured, the watch will exit the setting operation automatically after about two or three minutes of non-operation.

Useful Features

Pairing the watch with your phone makes a number of the watch's features easier to use.

Auto time correction

- 🔗 [Auto Time Correction](#)

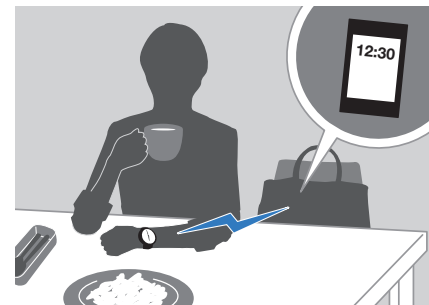

Selection of More Than 300 World Time cities

- 🔗 [Configuring World Time Settings](#)

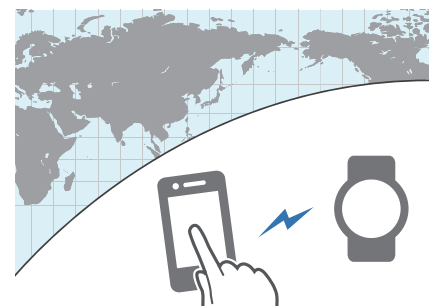

Stopwatch Data Transfer to the Phone

- 🔗 [Viewing Stopwatch Data](#)



In addition, a number of other watch settings can be configured using your phone.

To transfer data to a watch and to configure settings, you first need to pair the watch with your phone.

- 🔗 [Getting Ready](#)

- Your phone needs to have the "CASIO WATCHES" phone app installed to pair with the watch.

Linking with a Phone

While there is a Bluetooth connection between the watch and phone (Mobile Link), the watch's current time setting is corrected automatically. You can also change the watch's other settings.

Note

- This function is available only while the CASIO WATCHES phone app is running on the phone.
- This section describes watch and phone operations.
- 🕒 : Watch operation
- 📱 : Phone operation

Getting Ready

To use your watch in combination with a phone, you first need to pair them. Perform the steps below to pair the watch with a phone.

1. Install the app on your phone.
2. Configure Bluetooth settings.
3. Pair the watch with a phone.

● ① Install the app on your phone.

In Google Play or the App Store, search for the "CASIO WATCHES" phone app and install it on your phone.

● ② Configure Bluetooth settings.

Enable the phone's Bluetooth.

Note

- For details about setting procedures, see your phone documentation.

● ③ Pair the watch with a phone.

1. Move the phone to be paired with close to (within one meter of) the watch.
2. 📱 Tap the "CASIO WATCHES" icon.
3. 📱 Tap the + of the "My Watch" tab.
4. 🕒 Perform the operation shown on the phone screen to register the watch to the CASIO WATCHES phone app.
5. 🕒 Hold down (C) for at least three seconds until [CNCT] starts to flash. Release the button when the function hand moves to ⚡.

When a connection is established between the watch and phone, [CNCT] will stop flashing.

At this time the time settings of your phone and watch are synced with each other.

- If pairing fails for some reason, [ERR] appears on the display momentarily and then the watch returns to the Timekeeping Mode. Perform the pairing procedure again from the beginning.

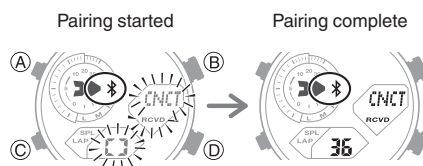

This completes the pairing operation. Once paired, the smartphone and watch automatically connect to synchronize the watch's time setting with that of the smartphone.

Note

- The first time you start up the CASIO WATCHES phone app, a message will appear on your phone asking if you want to enable location information acquisition. Configure settings to allow background use of location information.

Auto Time Correction

Your watch connects with a phone at preset times each day and correct its time settings automatically.

● Using This Function

Your watch corrects its time setting four times a day according to a preset schedule. If you leave your watch in the Timekeeping Mode, it will perform the correction operation automatically as you go about your daily life, without any operation required by you.



Important!

- The watch may not be able to perform auto time correction under the conditions described below.
 - While the watch is too far away from its paired phone
 - While communication is not possible due to radio interference, etc.
 - While the phone is updating its system
 - While the CASIO WATCHES phone app is not running on the phone

Note

- If the watch does not indicate the correct time even if it is able to connect with a phone, adjust the hand positions.
 - 🕒 [Adjusting Hand Alignment](#)
- If there is a World Time City specified with the CASIO WATCHES phone app, its time will also be corrected automatically.
- The watch connects with the phone and performs auto time correction at around 12:30 a.m., 6:30 a.m., 12:30 p.m. and 6:30 p.m. The connection is automatically terminated after auto time correction is complete.

● Triggering Immediate Time Correction

The watch's time setting is corrected automatically whenever you establish a connection between the watch and a phone. Whenever you want to trigger immediate time correction, perform the procedure below to connect with a phone.

1. Enter the Timekeeping Mode.
 [Navigating Between Modes](#)
2. Move the phone close to (within one meter of) the watch.
3. Press (D).

[TIME] flashes to indicate that the watch has started the connection operation. Once the watch and phone are connected, [OK] will appear, and then the watch will correct its time setting based on information from the phone.

- At this time your current location is recorded by your phone.

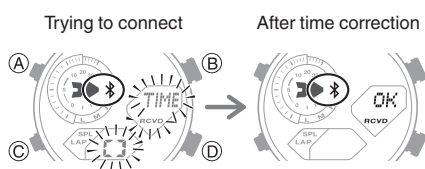

Note

- The connection is terminated automatically after time correction is complete.
- If time correction fails for some reason, [ERR] will appear.
- [RCVD] flashes when the receive operation starts, and [RCVD] stops flashing after it is complete.

Viewing Stopwatch Data

This section explains how to send lap times (up to 200 records) that are stored in watch memory, as well as other data to your phone for viewing with CASIO WATCHES.

● Sending Stopwatch Data to a Phone

Use the procedure below to send data from the watch to a phone.

1. Tap the "CASIO WATCHES" icon.
2. Hold down (C) for at least three seconds until [CNCT] starts to flash. Release the button when the function hand moves to .

When a connection is established between the watch and phone, [CNCT] will stop flashing.

- If connection fails for some reason, [ERR] will appear on the display momentarily and then the watch will return to the Timekeeping Mode.

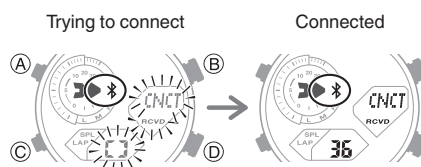

3. Perform the operation shown on the phone screen to transfer data measured by the watch to the phone.
After data transfer is complete, a list of the measurement data will appear on the phone display.
 - Tapping a stopwatch data item displays its details.

● Checking Sent Data

Use the CASIO WATCHES phone app to check the data you sent to the phone.

1. Tap the "CASIO WATCHES" icon.
2. Perform the operation shown on the phone screen to view the measurement data you want.

Note

- Tapping "Edit" displays a screen that you can use to change the data item title and to delete data.

Configuring World Time Settings

Specifying a World Time City with the CASIO WATCHES phone app causes the watch's World Time City to change accordingly. Settings can be configured to perform auto summer time switching for the World Time City.



Note

- The CASIO WATCHES phone app World Time lets you select from among approximately 300 cities as the World Time City.
- You can use the CASIO WATCHES phone app to configure settings for user cities that are not included in the watch's built-in World Time Cities. You must use the CASIO WATCHES phone app to select a user city as your World Time City.

● To select a World Time City

1. Tap the "CASIO WATCHES" icon.
2. Hold down (C) for at least three seconds until [CNCT] starts to flash. Release the button when the function hand moves to

When a connection is established between the watch and phone, [CNCT] will stop flashing.

- If connection fails for some reason, [ERR] will appear on the display momentarily and then the watch will return to the Timekeeping Mode.

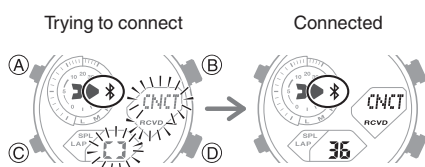

3. Perform the operation shown on the phone screen. The World Time setting will be reflected on the watch.

● Configuring the Summer Time Setting

1. Tap the "CASIO WATCHES" icon.
2. Hold down (C) for at least three seconds until [CNCT] starts to flash. Release the button when the function hand moves to

When a connection is established between the watch and phone, [CNCT] will stop flashing.

- If connection fails for some reason, [ERR] will appear on the display momentarily and then the watch will return to the Timekeeping Mode.

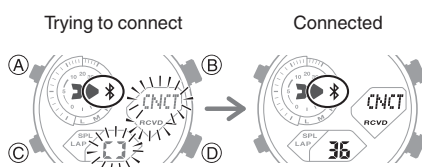

3. Perform the operation shown on the phone screen to select a summer time setting.
 - "Auto"

The watch switches between standard time and summer time automatically.
 - "OFF"

The watch always indicates standard time.
 - "ON"

The watch always indicates summer time.

Note

- While the summer time setting is "Auto", the watch switches between standard time and summer time automatically. You do not need to switch between standard time and summer time manually. Even if you are in an area that does not observe summer time, you can leave the watch's summer time setting as "Auto".
- For information about summer time periods, refer to the "Summer Time Table".

● Swapping Your World Time and Home Time

1. Tap the "CASIO WATCHES" icon.
2. Hold down (C) for at least three seconds until [CNCT] starts to flash. Release the button when the function hand moves to

When a connection is established between the watch and phone, [CNCT] will stop flashing.

- If connection fails for some reason, [ERR] will appear on the display momentarily and then the watch will return to the Timekeeping Mode.

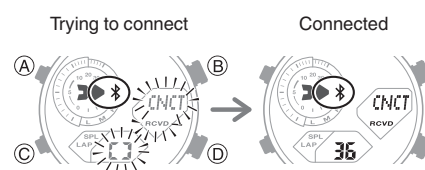

3. Perform the operation shown on the phone screen to swap your Home Time with your World Time.

Note

- Auto time correction does not work for 24 hours after swapping the Home Time and World Time.

Adjusting Hand Alignment

If the hands are out of alignment even though auto time correction is being performed, you can use the CASIO WATCHES phone app to adjust them.

1. Tap the "CASIO WATCHES" icon.
2. Hold down (C) for at least three seconds until [CNCT] starts to flash. Release the button when the function hand moves to

When a connection is established between the watch and phone, [CNCT] will stop flashing.

- If connection fails for some reason, [ERR] will appear on the display momentarily and then the watch will return to the Timekeeping Mode.

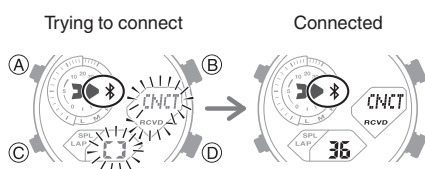

3. Perform the operation shown on the phone screen to correct hand alignment.

Phone Finder

You can use phone finder to trigger a tone on the phone to make it easy to find. The tone is forced to sound even if the phone is in vibrate mode.

Important!

- Do not use this function in areas where phone call tones are restricted.
- The tone sounds at a high volume. Do not use this function when listening to phone output over earphones.

1. If the watch is connected with a phone, press any button to terminate the connection.

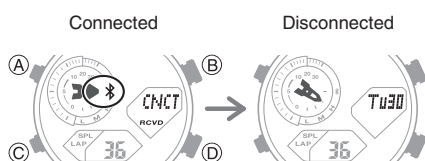

2. If the watch is in any mode besides the Timekeeping Mode, hold down (C) for at least one second to enter the Timekeeping Mode.

3. Hold down (D) for at least three seconds. Release the button when [FIND] starts to flash at low speed.

The phone sounds a tone when it establishes a connection with the watch.

- It takes a few seconds before the phone tone sounds.

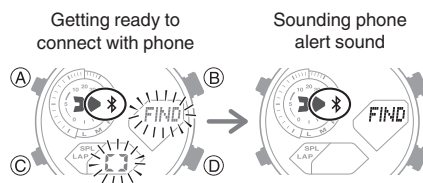

4. Press any button to stop the tone.
 - You can press any watch button to stop the phone tone only during the first 30 seconds after it starts to sound.

Configuring Watch Settings

Alarm time, timer start time, and other settings can also be configured using the CASIO WATCHES phone app.

1. Tap the "CASIO WATCHES" icon.
2. Hold down (C) for at least three seconds until [CNCT] starts to flash. Release the button when the function hand moves to

When a connection is established between the watch and phone, [CNCT] will stop flashing.

- If connection fails for some reason, [ERR] will appear on the display momentarily and then the watch will return to the Timekeeping Mode.

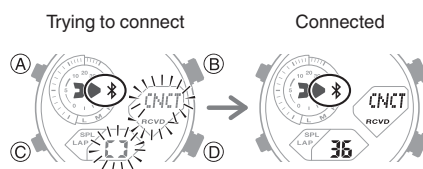

3. Select the setting you want to change and then perform the operation shown on the phone screen.

Changing the Home City Summer Time Setting

1. Tap the "CASIO WATCHES" icon.
2. Hold down (C) for at least three seconds until [CNCT] starts to flash. Release the button when the function hand moves to

When a connection is established between the watch and phone, [CNCT] will stop flashing.

- If connection fails for some reason, [ERR] will appear on the display momentarily and then the watch will return to the Timekeeping Mode.

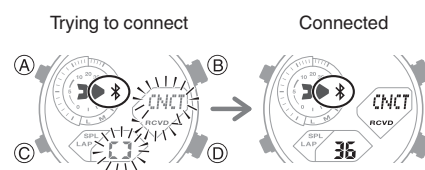

3. Perform the operation shown on the phone screen to change your Home City summer time setting.

Checking the Watch Charge Level

Use the procedure below to check the current charge level with CASIO WATCHES.

1. Tap the "CASIO WATCHES" icon.
2. Hold down (C) for at least three seconds until [CNCT] starts to flash. Release the button when the function hand moves to

When a connection is established between the watch and phone, [CNCT] will stop flashing.

- If connection fails for some reason, [ERR] will appear on the display momentarily and then the watch will return to the Timekeeping Mode.

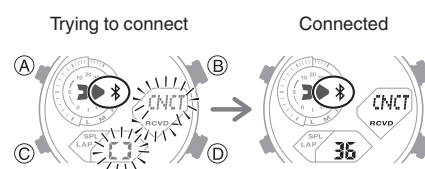

3. Use CASIO WATCHES to check the charge level.

Recording Your Current Location (TIME&PLACE)

While traveling or otherwise on the go, you can use the procedure below to record your current location, along with the time and date, on your phone. Recorded location information can be viewed on the CASIO WATCHES phone app map.

● Recording Your Current Location

1. Enter the Timekeeping Mode.
 [Navigating Between Modes](#)
2. When you are in the location you want to record, press (D).
This records, in phone memory, the latitude and longitude of the location you are in when you press the button, along with the date and time.
 - [OK] appears when registration is complete. [ERR] appears when registration fails.
 - At this time the time settings of your phone and watch are synced with each other.

● Viewing a Recorded Location on a Map

1. Tap the "CASIO WATCHES" icon.
2. Perform the operation shown on the phone screen to view recorded location information.

Note

- You can use the CASIO WATCHES phone app to delete recorded location information.

Connection

Connecting with a Phone

Your watch can connect with a phone that is paired with it.

- If the watch is not paired with the phone you want to connect with, refer to the information below and pair them.

[Pair the watch with a phone.](#)

● Connecting with a Phone

1. Move the phone close to (within one meter of) the watch.
2. Hold down (C) for at least three seconds until [CNCT] starts to flash. Release the button when the function hand moves to .

When a connection is established between the watch and phone, [CNCT] will stop flashing.

- If connection fails for some reason, [ERR] will appear on the display momentarily and then the watch will return to the Timekeeping Mode.

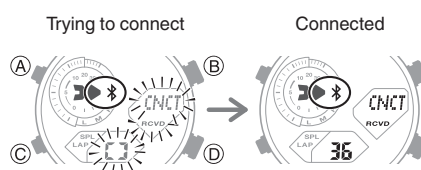

Important!

- If you have problems establishing a connection, it could mean that the CASIO WATCHES phone app is not running on your phone. On your phone's home screen, tap the "CASIO WATCHES" icon. After the app starts up, hold down the watch's (C) button for at least three seconds.

Note

- The connection is terminated if you do not perform any operation on the watch or phone for a fixed amount of time. To specify the connection limit time, perform the following operation with the CASIO WATCHES phone app: "Watch settings" → "Connection time with the app". Next, select a setting of 3 minutes, 5 minutes, or 10 minutes.

Disconnecting from Your Phone

Pressing any button terminates a Bluetooth connection and return to the Timekeeping Mode.

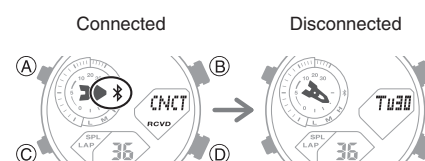

Unpairing

Unpairing the watch from a phone requires both the CASIO WATCHES phone app and watch operations.

● Deleting Pairing Information from the CASIO WATCHES phone app

1. Tap the "CASIO WATCHES" icon.
2. Perform the operation shown on the phone screen to unpair.

● Deleting Pairing Information from the Watch

1. Hold down (C) for at least one second to enter the Timekeeping Mode.
2. Hold down (A) for at least two seconds. Release the button when the name of the currently selected Home City appears on the display.
 - This is the setting mode. The hands automatically shift out of the way for easy viewing of the display and other indicators.

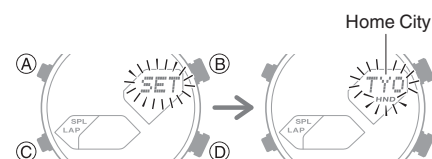

- Press (C) twice.

This causes the seconds to flash.

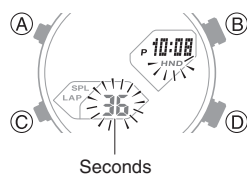

- Hold down (B) for at least three seconds. This will cause the [PAIR] and [CLR] indicators to alternate on the display. Release the button when only [CLR] is displayed.

This deletes the pairing information from the watch and returns to the timekeeping display.



- Press (A) to return to the Timekeeping Mode.

If you purchase another phone

You need to perform the pairing operation whenever you want to establish a Bluetooth connection with a phone for the first time.

- Deleting Pairing Information from the Watch
- Pair the watch with a phone.

Time Adjustment

Your watch can connect with a phone to obtain information that it uses to correct its date and time setting.

Important!

- When you are on an aircraft or in any other location where radio signals area may cause problems, enable the watch's Airplane Mode to disable connection with your phone.
 - Using the Watch in a Medical Facility or Aircraft

Referring to the information below, configure the time setting in accordance with the method that suits your own lifestyle.

Do you use a phone?

Time correction by connecting with your phone is recommended.

- Getting Ready
- Auto Time Correction

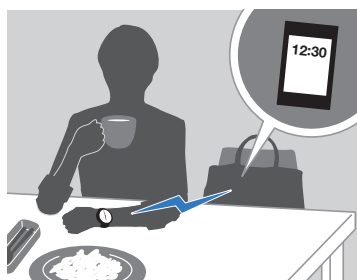

If your phone cannot connect with the watch

You can correct time settings by performing operations on the watch.

- Using Watch Operations to Adjust the Time Setting



Using Watch Operations to Adjust the Time Setting

If your watch cannot connect with a phone for some reason, you can use watch operations to adjust date and time settings.

Setting a Home City

Use the procedure in this section to select a city to use as your Home City. If you are in an area that observes summer time, you can also configure a summer time setting.

Note

- The initial factory default summer time setting for all cities is [AUTO]. In many cases, the [AUTO] setting lets you use the watch without switching between summer time and standard time.
- While the setting is being configured, the watch will exit the setting operation automatically after about two or three minutes of non-operation.

- Enter the Timekeeping Mode.
 - Navigating Between Modes
- Hold down (A) for at least two seconds. Release the button when the name of the currently selected Home City appears on the display.
 - This is the setting mode. The hands automatically shift out of the way for easy viewing of the display and other indicators.

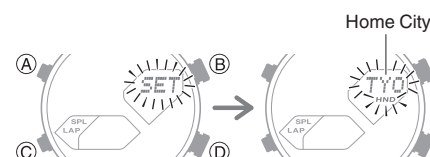

- Use (B) and (D) to change the Home City setting.
 - Holding down (B) or (D) scrolls through settings at high speed.
 - For details refer to the information below.
 - City Table
- Press (C).

5. Use (D) to select a summer time setting.
Each press of (D) cycles through available settings in the sequence shown below.

- [AUTO]
The watch switches between standard time and summer time automatically.
- [OFF]
The watch always indicates standard time.
- [ON]
The watch always indicates summer time.

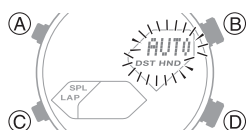

6. Press (A) to complete the setting operation.

● Setting the Time/Date

1. Enter the Timekeeping Mode.
[Navigating Between Modes](#)
2. Hold down (A) for at least two seconds. Release the button when the name of the currently selected Home City appears on the display.
 - This is the setting mode. The hands automatically shift out of the way for easy viewing of the display and other indicators.

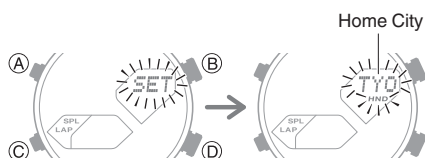

3. Keep pressing (C) until the setting you want to change is flashing.

- Each press of (C) moves the flashing to the next setting in the sequence shown below.

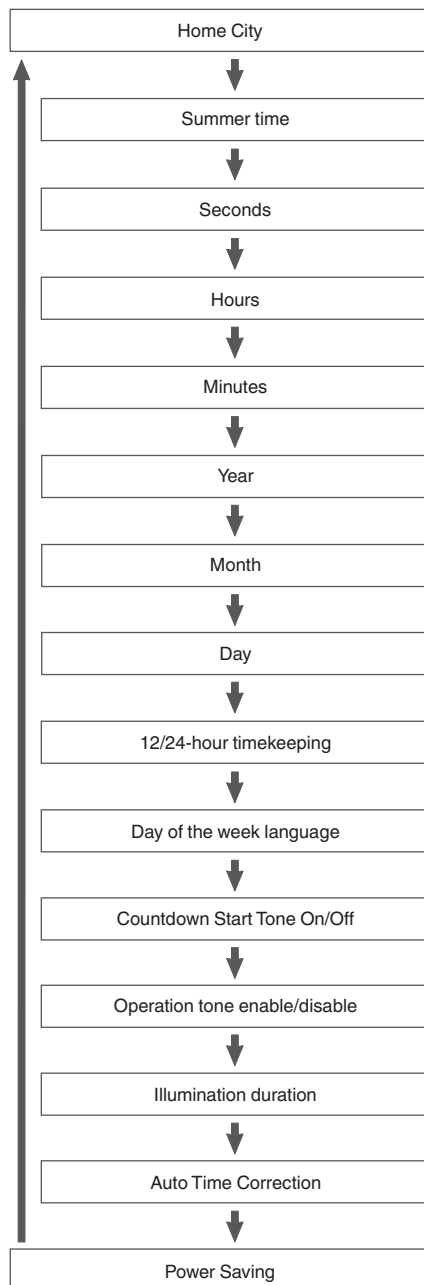

4. Configure the date and time settings.

- To reset the seconds to 00: Press (D). 1 is added to the minutes when the current count is between 30 and 59 seconds.
- For all the other settings, use (B) and (D) to change the flashing setting. Holding down (B) or (D) scrolls through settings at high speed.

5. Repeat steps 3 and 4 to select time and date settings.

6. Press (A) to complete the setting operation.

Note

- While the setting is being configured, the watch will exit the setting operation automatically after about two or three minutes of non-operation.

● Switching between 12-hour and 24-hour Timekeeping

You can specify either 12-hour format or 24-hour format for the time display.

1. Enter the Timekeeping Mode.
[🔍 Navigating Between Modes](#)
2. Hold down (A) for at least two seconds. Release the button when the name of the currently selected Home City appears on the display.
 - This is the setting mode. The hands automatically shift out of the way for easy viewing of the display and other indicators.

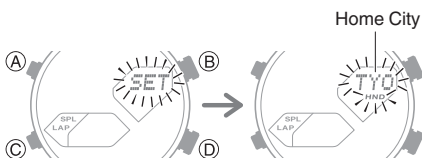

3. Press (C) eight times.
 This causes [12H] or [24H] to flash on the display.

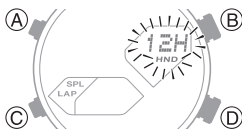

4. Press (D) to toggle the setting between [12H] (12-hour timekeeping) and [24H] (24-hour timekeeping).

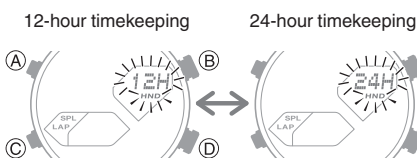

5. Press (A) to complete the setting operation.

Note

- While the setting is being configured, the watch will exit the setting operation automatically after about two or three minutes of non-operation.

Using the Watch in a Medical Facility or Aircraft

Whenever you are in a hospital, on an aircraft, or in any other location where connection with a phone may cause problems, you can perform the procedure below to disable auto time correction. To re-enable auto time correction, perform the same operation again.

1. Enter the Timekeeping Mode.
[🔍 Navigating Between Modes](#)
2. Hold down (A) for at least two seconds. Release the button when the name of the currently selected Home City appears on the display.

- This is the setting mode. The hands automatically shift out of the way for easy viewing of the display and other indicators.

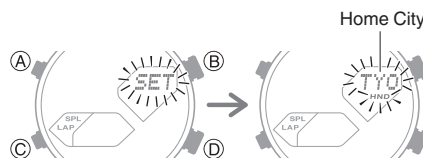

3. Press (C) 13 times.
 This displays [RCVD].

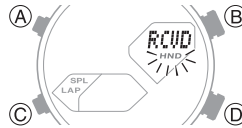

4. Press (D) to change the auto time correction settings.
 [OFF]: Auto time correction disabled.
 [ON]: Auto time correction enabled.
5. Press (A) to complete the setting operation.

Note

- The auto time correction setting can be changed only while the watch is paired with a phone.
- While the setting is being configured, the watch will exit the setting operation automatically after about two or three minutes of non-operation.

World Time

World Time lets you look up the current time in any one of 38 cities around the globe, and UTC (Coordinated Universal Time).



Using CASIO WATCHES to Configure World Time City Settings

If the watch is paired with a phone, you can also use the CASIO WATCHES phone app to set the World Time city.

[🔍 Configuring World Time Settings](#)

Note

- World Time cities that can be selected only by using the CASIO WATCHES phone app cannot be selected using watch operations.

Checking World Time

1. Enter the World Time Mode.
[🔍 Navigating Between Modes](#)
 After the currently selected World Time City name appears, the watch will display the current time in that city.
 - You can display the World Time City while in the World Time Mode by pressing (A).

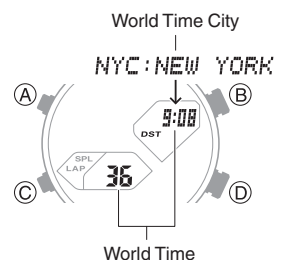

World Time City Setting

Use the procedure in this section to select a World Time city. If you are in an area that observes summer time, you can also configure a summer time setting.

Note

- The initial factory default summer time setting for all cities is [AUTO]. In many cases, the [AUTO] setting lets you use the watch without switching between summer time and standard time.

1. Enter the World Time Mode.
[Navigating Between Modes](#)
2. Use (D) to display the city you want.
 - Holding down (D) scrolls through settings at high speed.

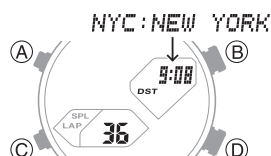

3. To change the summer time setting, hold down (A) for at least two seconds. Release the button when the current summer time setting starts to flash.
 - This is the setting mode. The hands automatically shift out of the way for easy viewing of the display and other indicators.

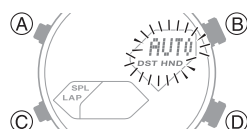

4. Use (D) to change the summer time setting.

Each press of (D) cycles through settings in the sequence shown below.

- [AUTO]
The watch switches between standard time and summer time automatically.
- [OFF]
The watch always indicates standard time.
- [ON]
The watch always indicates summer time.

5. Press (A) to exit the setting screen.

Note

- While the setting is being configured, the watch will exit the setting operation automatically after about two or three minutes of non-operation.
- While [UTC] is selected as the city, you will not be able to change or check the summer time setting.
- If you select a World Time City with the CASIO WATCHES phone app and then change to a different city with a watch operation, the CASIO WATCHES city information is deleted from the watch.

[Configuring World Time Settings](#)

Swapping Your Home Time and World Time

In the World Time mode, press (A) and (B) at the same time to swap your Home City time with your World Time.

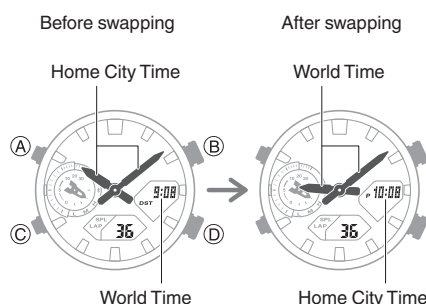

Note

- This function comes in handy when you need to move to another time zone. For details about how to use it, go to the section below.

[Moving to Another Time Zone](#)

Moving to Another Time Zone

Use the procedure below to easily change day and time settings of the watch to a destination location.

Before Boarding

1. Configure the World Time to the current time at your destination.

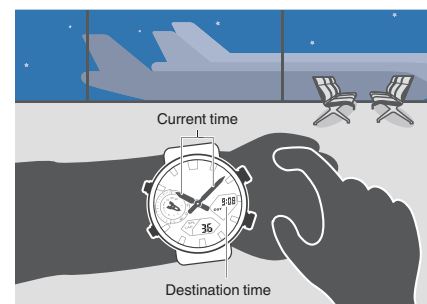

[Using CASIO WATCHES to Configure Settings](#)

[Using Watch Operations to Configure Settings](#)

2. Disable auto time correction.

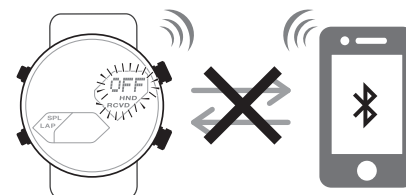

[Using the Watch in a Medical Facility or Aircraft](#)

● After Arriving

1. Swap the origin time zone time with the destination time zone time.

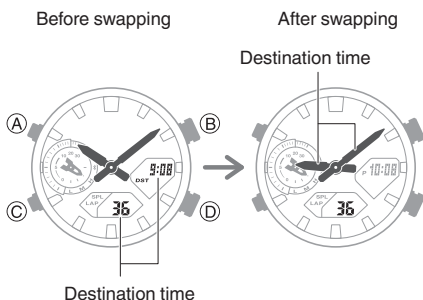

- Using CASIO WATCHES to Configure Settings
- Using Watch Operations to Configure Settings

2. Enable auto time correction.

- Using the Watch in a Medical Facility or Aircraft

3. Correct the time setting.

- Triggering Immediate Time Correction

Alarm

The watch beeps when an alarm time is reached. You can set up to five different alarms. The hourly time signal causes the watch to beep every hour on the hour.

- The alarm sound is muted in the cases described below.
 - When battery power is low
 - When watch is at Level 2 power saving

Power Saving Function



Using CASIO WATCHES to Configure Alarm Settings

If the watch is paired with a phone, you can also use the CASIO WATCHES phone app to set alarms.

Configuring Watch Settings

Configuring Alarm Settings

1. Enter the Alarm Mode.
 - Navigating Between Modes
2. Press (D) to scroll through alarm numbers ([AL1] to [AL5]) until the alarm you want to configure is displayed.

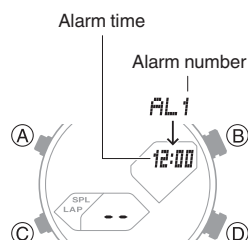

3. Hold down (A) for at least two seconds. Release the button when the hours digits start to flash.

- This is the setting mode. The hands automatically shift out of the way for easy viewing of the display and other indicators.
- While the setting is being configured, the watch will exit the setting operation automatically after about two or three minutes of non-operation.

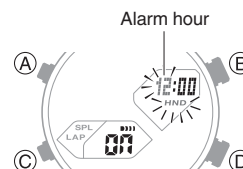

4. Use (B) and (D) to change the hour setting.

- Holding down (B) or (D) scrolls through settings at high speed.
- If you are using 12-hour timekeeping, [P] indicates p.m.

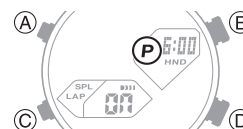

5. Press (C).

This causes the minutes digits to flash.

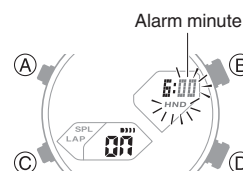

6. Use (B) and (D) to set the minute setting.

7. Press (A) to exit the setting screen.

- (Alarm) is shown on the display while an alarm is turned on.

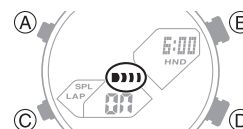

● To stop the alarm

Pressing any button while the beeper is sounding stops it.

Note

- A beeper sounds for 10 seconds when an alarm time is reached.
- The watch automatically returns from the Alarm Mode to the Timekeeping Mode if you do not perform any operation for about two or three minutes.

Enabling the Hourly Time Signal

1. Enter the Alarm Mode.

[Navigating Between Modes](#)

2. Use (D) to display the hourly time signal screen ([SIG]).

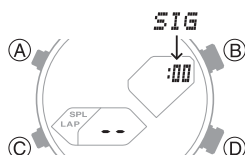

3. Press (A) to toggle the hourly time signal between enabled and disabled.

- (hourly time signal) is shown on the display while the hourly time signal is enabled.

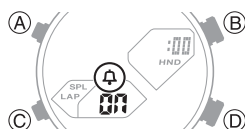

Turning Off an Alarm or the Hourly Time Signal

To stop an alarm or the hourly time signal from sounding, perform the steps below to turn it off.

- To have an alarm or hourly time signal sound again, turn it back on.

Note

- Indicators are displayed while any of the alarms or the hourly time signal is turned on.
- The applicable indicators are not displayed while all of the alarms are turned off and/or the hourly time signal is turned off.

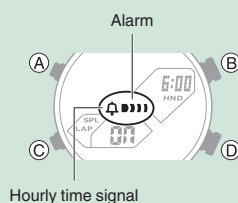

1. Enter the Alarm Mode.

[Navigating Between Modes](#)

2. Use (D) to scroll through the alarm ([AL1] to [AL5]) and hourly time signal ([SIG]) screens until the one you want to turn off is displayed.

Alarm number or hourly time signal

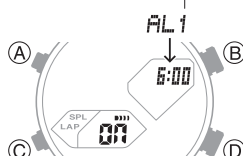

3. Press (A) to turn off the displayed alarm or the hourly time signal.

- Each press of (A) toggles between on and off.
- Turning off all alarms causes (alarm) to disappear from the display. Turning off the hourly time signal causes (hourly time signal) to disappear.

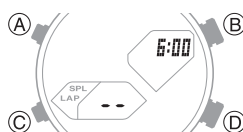

Note

- If (alarm) is still displayed after you turn off an alarm, it means that at least one of the other alarms is still turned on. To turn off all of the alarms, repeat steps 2 and 3 until the (alarm) indicator is no longer displayed.

Alarm Countdown Indication

30 minutes before an alarm time is reached, a countdown start tone sounds and the function hand starts to indicate the remaining time until the alarm time.

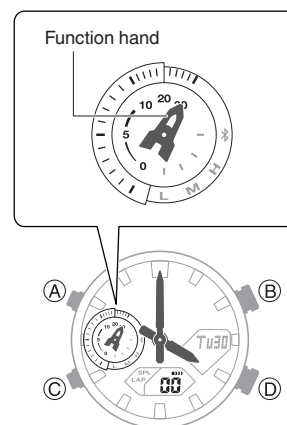

Note

- You can use the procedure below to enable or disable the countdown start tone. [Disabling the Countdown Start Tone](#)
- During a period within 30 minutes of both an alarm time and the end of a timer operation, the function hand indicates the timer countdown.

Stopwatch

The stopwatch measures elapsed time in 1/100-second units for the first hour, and in 1-second units after that for up to 24 hours.

In addition to normal elapsed time measurements, the stopwatch also lets you take split time and lap time readings.



Note

- Up to 200 split time and lap time records can be stored in watch memory. Perform a lap or split time operation while there are already 200 records in memory will cause the oldest record to be deleted automatically to make room for the new one.
- If you want to keep previous elapsed time measurement data from being deleted, transfer it to a phone.
[Viewing Stopwatch Data](#)

Split Times and Lap Times

● Split time

A split time is the time elapsed from the start, up to any point along the course of an event.

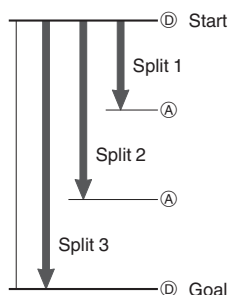

● Lap time

A lap time shows the time elapsed during a specific lap around a track, etc.

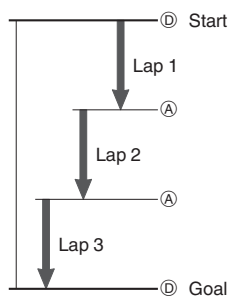

Measuring Elapsed Time

1. Enter the Stopwatch Mode.
[Navigating Between Modes](#)
2. Use the operations below to measure elapsed time.



- Elapsed time is shown in 1/100-second units for the first hour of the measurement. After the first hour, elapsed time is shown in one-second units.

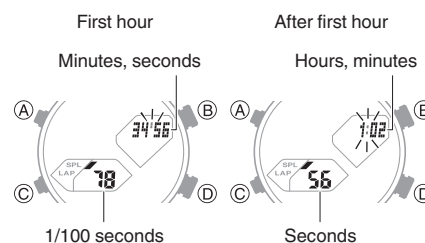

3. Press (A) to reset the measurement time to all zeros.

Measuring a Split Time

1. Enter the Stopwatch Mode.

[Navigating Between Modes](#)

- If a stopwatch timing operation is in progress, press (D) to stop it and then press (A) to reset the stopwatch to all zeros before performing the operation in step 2.

2. Press (A) to display [SPL].

- Each press of (A) toggles between [SPL] (split time) and [LAP] (lap time).

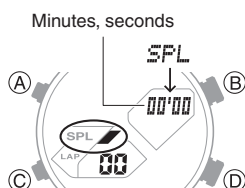

3. Use the operations below to measure elapsed time.

- Pressing (A) displays the elapsed time up to that point (split time), alternating with [SPL] for about eight seconds.



- Elapsed time is shown in 1/100-second units for the first hour of the measurement. After the first hour, elapsed time is shown in one-second units.

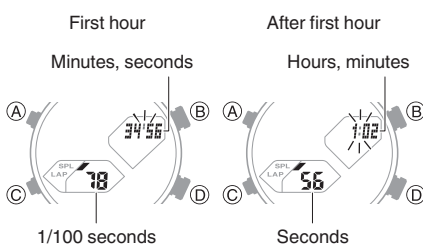

4. Press (A) to reset the measurement time to all zeros.

Measuring Lap Times

1. Enter the Stopwatch Mode.

[Navigating Between Modes](#)

- If a stopwatch timing operation is in progress, press (D) to stop it and then press (A) to reset the stopwatch to all zeros before performing the operation in step 2.

2. Press (A) to display [LAP].

- Each press of (A) toggles between [SPL] (split time) and [LAP] (lap time).

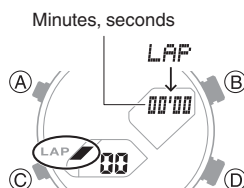

3. Use the operations below to measure elapsed time.

- Each time you press (A), the watch displays the time elapsed (lap time) since the last lap time operation, alternating with the stopwatch number for about eight seconds.



- Elapsed lap time is displayed in 1/100-second units for the first hour. After that, it is displayed in one-second units.

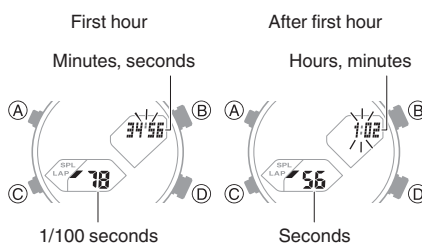

4. Press (A) to reset the measurement time to all zeros.

Timer

The timer counts down from a start time specified by you. A beeper sounds when the end of the countdown is reached.

- The beeper is muted when battery power is low.



Using CASIO WATCHES to Configure Timer Settings

If the watch is paired with a phone, you can also use the CASIO WATCHES phone app to set the timer start time.

[Configuring Watch Settings](#)

Setting the Countdown Start Time

The start time can be set in 1-second units up to 60 minutes.

- If a timer countdown operation is in progress, reset the timer to its current start time before performing this operation.

[Using the Timer](#)

1. Enter the Timer Mode.

[Navigating Between Modes](#)

2. Hold down (A) for at least two seconds. Release the button when the minutes setting starts to flash.

- This is the setting mode. The hands automatically shift out of the way for easy viewing of the display and other indicators.



3. Use (B) and (D) to change the minutes setting.

- Holding down (B) or (D) scrolls through settings at high speed.

4. Press (C).

This causes the seconds digits to flash.

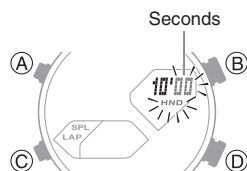

5. Use (B) and (D) to change the seconds setting.

6. Press (A) to exit the setting screen.

Note

- Setting a start time of [00'00] will perform a countdown of 60 minutes.
- While the setting is being configured, the watch will exit the setting operation automatically after about two or three minutes of non-operation.

Using the Timer

1. Enter the Timer Mode.

[Navigating Between Modes](#)

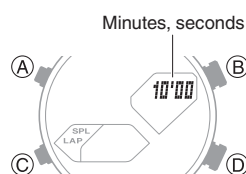

2. Use the operations below to perform a timer operation.

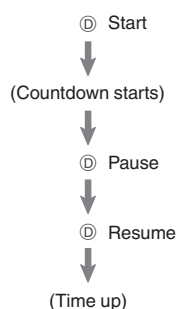

- A beeper sounds for 10 seconds to let you know when the end of a countdown is reached.
 - You can reset a paused countdown to its start time, by pressing (A).
3. Press any button to stop the tone.

Timer Countdown Indication

30 minutes before the end of a timer operation is reached, a countdown start tone sounds and the function hand starts to indicate the remaining time until the end of the timer operation.

- The countdown start tone will not sound when the timer start time is 30 minutes or less.

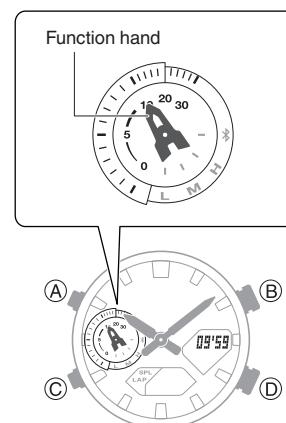

Note

- You can use the procedure below to enable or disable the countdown start tone.
- [Disabling the Countdown Start Tone](#)
- During a period within 30 minutes of both an alarm time and the end of a timer operation, the function hand indicates the timer countdown.

Hand Alignment Adjustment

Strong magnetism or impact can cause the time indicated by the analog hands to become different from the time on the digital display. If this happens, adjust hand alignment.

Using CASIO WATCHES to Adjust Hand Alignment

If the watch is paired with a phone, you can also use CASIO WATCHES to adjust hand alignment.

[Adjusting Hand Alignment](#)

Adjusting Hand Alignment

1. Enter the Timekeeping Mode.
[Navigating Between Modes](#)
2. Hold down (A) for at least five seconds. Release the button when [SUB] starts to flash.

This starts the function hand indicator alignment operation.

After 3.5 seconds

After five seconds

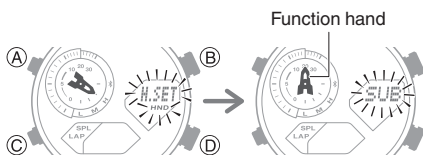

3. If the function hand is not aligned with 12 o'clock, use (B) and (D) to align it.

4. Press (C).

This enables adjustment of the hour and minute hands.

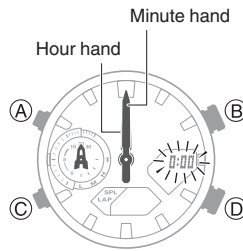

5. If the hour and minute hands are not at 12 o'clock, use (B) and (D) to align them.
6. Press (A) to exit the setting screen.

Note

- During hand alignment adjustment, the watch automatically returns to the Timekeeping Mode after two or three minutes of non-operation.

Other Settings

This section explains other watch settings you can configure.

Specifying the Day of the Week Language

You can select any one of six languages for the day of the week display in the Timekeeping Mode.

1. Enter the Timekeeping Mode.
[Navigating Between Modes](#)
2. Hold down (A) for at least two seconds until the name of the currently selected Home City is displayed.
 - This is the setting mode. The hands automatically shift out of the way for easy viewing of the display and other indicators.

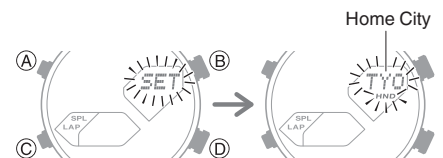

3. Press (C) nine times. This causes the language setting to flash.

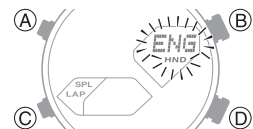

4. Use (D) to select a language.
 - [ENG]: English
 - [ESP]: Spanish
 - [FRA]: French
 - [DEU]: German
 - [ITA]: Italian
 - [PyC]: Russian
5. Press (A) to exit the setting screen.

Note

- While the setting is being configured, the watch will exit the setting operation automatically after about two or three minutes of non-operation.

Disabling the Countdown Start Tone

You can use the procedure below to enable or disable the countdown start tone that sounds when the function hand starts a countdown operation 30 minutes before an alarm time or before the end of a timer operation.

1. Enter the Timekeeping Mode.
[🔗 Navigating Between Modes](#)
2. Hold down (A) for at least two seconds. Release the button when the name of the currently selected Home City appears on the display.
 - This is the setting mode. The hands automatically shift out of the way for easy viewing of the display and other indicators.

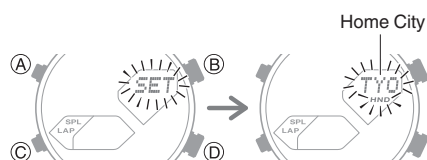

3. Press (C) 10 times.
 This causes [PROGRESS↵] to appear. Next, [↵ON] or [↵OFF] will flash on the display.

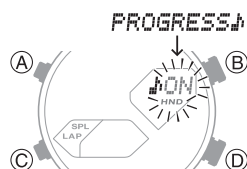

4. Press (D) to select [↵ON] or [↵OFF].
 [↵ON]: Tone enabled.
 [↵OFF]: Tone disabled.

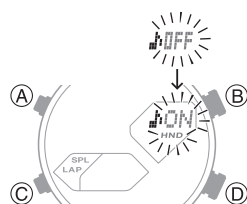

5. Press (A) to exit the setting screen.

Note

- While the setting is being configured, the watch will exit the setting operation automatically after about two or three minutes of non-operation.

Enabling the Button Operation Tone

Use the procedure below to enable or disable the tone that sounds when you press a button.

1. Enter the Timekeeping Mode.
[🔗 Navigating Between Modes](#)
2. Hold down (A) for at least two seconds until the name of the currently selected Home City is displayed.
 - This is the setting mode. The hands automatically shift out of the way for easy viewing of the display and other indicators.

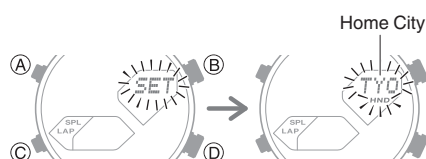

3. Press (C) 11 times.
 This causes [KEY↵] or [MUTE] to flash on the display.

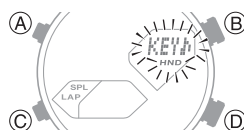

4. Press (D) to select [KEY↵] or [MUTE].
 [KEY↵]: Operation tone enabled.
 [MUTE]: Operation tone muted.

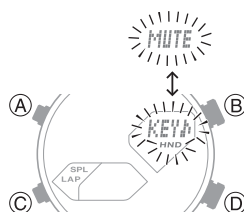

5. Press (A) to exit the setting screen.

Note

- While the setting is being configured, the watch will exit the setting operation automatically after about two or three minutes of non-operation.
- Note that alarm and timer tones still sound even while the operation tone is muted.

Configuring Power Saving Function Settings

1. Enter the Timekeeping Mode.
[🔗 Navigating Between Modes](#)
2. Hold down (A) for at least two seconds until the name of the currently selected Home City is displayed.
 - This is the setting mode. The hands automatically shift out of the way for easy viewing of the display and other indicators.

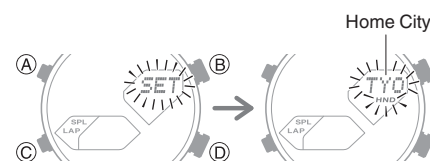

3. Press (C) 14 times.
 This displays [PSON] or [PSOF].

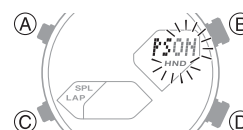

4. Press (D) to toggle between on and off.
 [PSON]: Power Saving enabled.
 [PSOF]: Power Saving disabled.
5. Press (A) to exit the setting screen.

Note

- While the setting is being configured, the watch will exit the setting operation automatically after about two or three minutes of non-operation.
- For details about Power Saving, refer to the information below.
[🔗 Power Saving Function](#)

Resetting Watch Settings

This section explains how to return the watch settings below to their initial factory defaults.

- Watch Settings
- Stopwatch
- Timer
- Alarm

1. Enter the Timekeeping Mode.
 Navigating Between Modes

2. Hold down (A) for at least two seconds until the name of the currently selected Home City is displayed.

- This is the setting mode. The hands automatically shift out of the way for easy viewing of the display and other indicators.

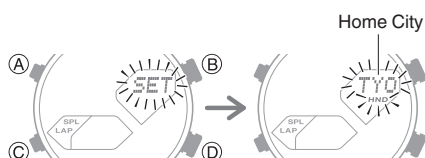

3. Press (C) twice.

This causes the seconds to flash.

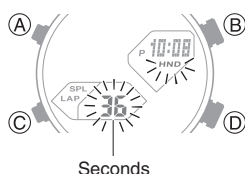

4. Hold down (B) for at least seven seconds. This will cause the [ALL] and [RESET] indicators to alternate on the display. Release the button when only [RESET] is displayed.

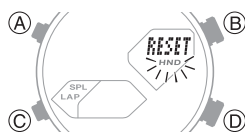

5. Press (A) to exit the setting screen.

Note

- While the setting is being configured, the watch will exit the setting operation automatically after about two or three minutes of non-operation.
- Resetting the watch also deletes information for pairing the watch with a phone, and unpair them.

Specifications

Accuracy at normal temperature :

±15 seconds per month when time correction by communication with a phone is not possible.

Timekeeping :

Analog

Hour, minute (moves every 20 seconds)

Digital

Hour, minute, second, month, day, day of the week

a.m./p.m.(P)/24-hour timekeeping

Full Auto Calendar (2000 to 2099)

Summer Time

World Time :

38 cities (38 time zones) and Coordinated

Universal Time (UTC)

Summer time

Home City Time swapping

Stopwatch :

Measurement unit:

1/100 second (first hour)

1 second (after first hour)

Measuring range: 23 hours 59 minutes 59 seconds

Measurement Functions:

Elapsed time, split times, lap times

Timer :

Measuring unit: 1 second

Measuring range: 60 minutes

Time setting unit: 1 second

Time setting range: 1 second to 60 minutes

10-second beeper when the end of the countdown is reached

Countdown start tone

Alarm :

Daily alarm

Number of alarms

5 (with countdown start tone)

Setting units

Hours, minutes

Alarm tone duration: 10 seconds

Hourly time signal: Beep every hour on the hour

Mobile Link :

Auto Time Correction

Time setting corrected automatically at preset time

One-touch Time Correction

Manual connection and time correction

Phone finder

Watch operation sounds the alert sound of the mobile phone

World Time

Current time for approximately 300 cities selected for the watch

Home Time/World Time swapping

Auto Summer Time Switching

Automatic switching between standard time and summer time

Timer Settings

Alarm Settings

Stopwatch data transfer

1/1000-second Stopwatch:

200 lap/split time records (date and time, lap/split time, lap number)

Hand alignment correction

TIME&PLACE

Data Communication Specifications

Bluetooth®

Frequency Band: 2400MHz to 2480MHz

Maximum Transmission: 0 dBm (1 mW)

Communication range: Up to 2 meters

(depends on environment)

Double LED light :

Face LED light: Super Illuminator,

afterglow, selectable illumination duration (approximately 1.5 seconds or 3 seconds)

LCD LED backlight: Super Illuminator,

afterglow, selectable illumination duration (approximately 1.5 seconds or 3 seconds)

Other :

Power Saving, battery Indicator, selectable

day of the week language, auto time

correction on/off, operation tone on/off,

Hand Shift, countdown start tone on/off

Power Supply :

Solar panel and one rechargeable battery

(Type: CTL920)

Battery nominal voltage: 2.3V

Battery operating time: Approximately 7 months

Conditions:

Auto Time Correction: 4 times/day

Alarm: Once (10 seconds)/day

Illumination: Once (1.5 seconds)/day

Power Saving: 6 hours/day

Specifications are subject to change without notice.

Other Information

This section provides non-operational information you also need to know. Refer to this information as required.

City Table

City	Offset
UTC	Coordinated Universal Time 0
LON: LONDON	London 0
PAR: PARIS	Paris +1
ATH: ATHENS	Athens +2
JED: JEDDAH	Jeddah +3
THR: TEHRAN	Tehran +3.5
DXB: DUBAI	Dubai +4
KBL: KABUL	Kabul +4.5
KHI: KARACHI	Karachi +5
DEL: DELHI	Delhi +5.5
KTM: KATHMANDU	Kathmandu +5.75
DAC: DHAKA	Dhaka +6
RGN: YANGON	Yangon +6.5
BKK: BANGKOK	Bangkok +7
HKG: HONG KONG	Hong Kong +8
EUC: EUCLA	Eucla +8.75
TYO: TOKYO	Tokyo +9
ADL: ADELAIDE	Adelaide +9.5
SYD: SYDNEY	Sydney +10
LDH: LORD HOWE ISLAND	Lord Howe Island +10.5
NOU: NOUMEA	Noumea +11
WLG: WELLINGTON	Wellington +12
CHT: CHATHAM ISLAND	Chatham Islands +12.75
TBU: NUKUALOFA	Nuku'alofa +13
CXI: KIRITIMATI	Kiritimati +14

City	Offset
BAR: BAKER ISLAND	Baker Island -12
PPG: PAGO PAGO	Pago Pago -11
HNL: HONOLULU	Honolulu -10
NHV: MARQUESAS ISLANDS	Marquesas Islands -9.5
ANC: ANCHORAGE	Anchorage -9
LAX: LOS ANGELES	Los Angeles -8
DEN: DENVER	Denver -7
CHI: CHICAGO	Chicago -6
NYC: NEW YORK	New York -5
YHZ: HALIFAX	Halifax -4
YYT: ST. JOHN'S	St. John's -3.5
RIO: RIO DE JANEIRO	Rio de Janeiro -3
FEN: F. DE NORONHA	Fernando de Noronha -2
RAI: PRAIA	Praia -1

- The information in the above table is current as of January 2025.
- Time zones may change and UTC differentials may become different from those shown in the table above. If this happens, connect the watch with a phone to update the watch with the latest time zone information.

Summer Time Table

When [AUTO] is selected for a city that observes summer time, switching between standard time and summer time will be performed automatically at the timing shown in the table below.

Note

- Summer time start and end dates for your current location may be different from those shown below. If this happens, you can have new summer time information for your Home City and World Time City sent to the watch by connecting the watch with a phone. If the watch is not connected with a phone, you can change the summer time setting manually.

City Name	Summer Time Start	Summer Time End
London	01:00, last Sunday in March	02:00, last Sunday in October
Paris	02:00, last Sunday in March	03:00, last Sunday in October
Athens	03:00, last Sunday in March	04:00, last Sunday in October
Tehran	00:00, March 22 or 21	00:00, September 22 or 21
Sydney, Adelaide	02:00, first Sunday in October	03:00, first Sunday in April
Lord Howe Island	02:00, first Sunday in October	02:00, first Sunday in April
Wellington	02:00, last Sunday in September	03:00, first Sunday in April
Chatham Islands	02:45, last Sunday in September	03:45, first Sunday in April
Anchorage	02:00, second Sunday in March	02:00, first Sunday in November
Los Angeles	02:00, second Sunday in March	02:00, first Sunday in November
Denver	02:00, second Sunday in March	02:00, first Sunday in November
Chicago	02:00, second Sunday in March	02:00, first Sunday in November
New York	02:00, second Sunday in March	02:00, first Sunday in November
Halifax	02:00, second Sunday in March	02:00, first Sunday in November
St. John's	02:00, second Sunday in March	02:00, first Sunday in November

- The information in the above table is current as of January 2022.

Supported Phones

For information about phones that can connect with the watch, visit the CASIO website.

https://world.casio.com/os_mobile/wat/

Copyrights and Registered Copyrights

- The Bluetooth® word mark and logos are registered trademarks owned by the Bluetooth SIG, Inc. and any use of such marks by CASIO Computer Co., Ltd. is under license.
- iPhone and App Store are trademarks of Apple Inc. in the United States and other countries.
- IOS is a trademark or registered trademark of Cisco Systems, Inc.
- Android and Google Play™ are trademarks or registered trademarks of Google LLC.
- Other company names and product names used herein are trademarks or registered trademarks of their respective companies.

Troubleshooting

I can't pair the watch with a phone.

Q1 I've never been able to establish a (pairing) connection between the watch and phone.

Are you using a supported phone model?

Check if the phone model and its operating system are supported by the watch.

For information about supported phone models, visit the CASIO Website.

https://world.casio.com/os_mobile/wat/

Did you install the CASIO WATCHES phone app on your phone?

The CASIO WATCHES phone app needs to be installed on your phone in order to connect with the watch.

🔗 ① [Install the app on your phone.](#)

Are your phone's Bluetooth settings configured correctly?

Configure the phone's Bluetooth settings. For details about setting procedures, see your phone documentation.

iPhone Users

- "Settings" → "Bluetooth" → On
- "Settings" → "Privacy" → "Bluetooth" → "CASIO WATCHES" → On

Android Users

- Enable Bluetooth.

Other than the above.

Some phones need to have BT Smart disabled to use the CASIO WATCHES phone app. For details about setting procedures, see your phone documentation.

On the Home Screen, tap: "Menu" → "Settings" → "Bluetooth" → "Menu" → "BT Smart settings" → "Disable".

I can't reconnect the watch and phone.

Q1 The watch will not re-connect with the phone after they are disconnected.

Is the CASIO WATCHES phone app running?

The watch cannot re-connect with your phone unless the CASIO WATCHES phone app is running on the phone. On your phone's Home Screen, tap the "CASIO WATCHES" icon. Next, on the watch, hold down (C) for at least three seconds.

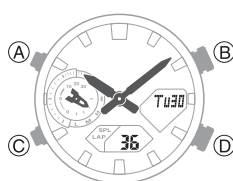

Have you tried turning your phone off and then back on again?

Turn your phone off and then back on, and then tap the "CASIO WATCHES" icon. Next, on the watch, hold down (C) for at least three seconds.

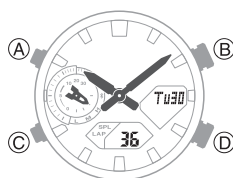

Is a timer countdown operation in progress?

Connection with a phone is not possible while there is 30 seconds or less remaining on a countdown timer operation. Stop the countdown operation before connecting with the phone.

Q2 I can't connect while my phone is in the Airplane Mode.

Connection with the watch is not possible while the phone's Airplane Mode is enabled. After disabling the phone's Airplane Mode, go to the phone's Home Screen and tap the "CASIO WATCHES" icon. Next, on the watch, hold down (C) for at least three seconds.

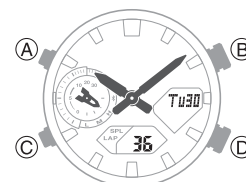

Q3 I changed the phone's Bluetooth from enabled to disabled, and now I can't connect anymore.

On your phone, re-enable Bluetooth, and then go to the Home Screen and tap the "CASIO WATCHES" icon. Next, on the watch, hold down (C) for at least three seconds.

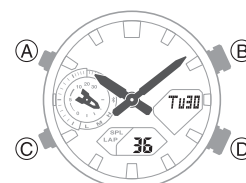

Q4 I can't connect after turning off the phone.

Turn your phone off and then back on, and then tap the "CASIO WATCHES" icon. Next, on the watch, hold down (C) for at least three seconds.

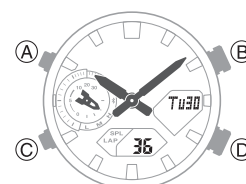

Phone-Watch Connection

Q1 I can't establish a connection between the phone and watch.

Have you tried turning your phone off and then back on again?

Turn your phone off and then back on, and then tap the "CASIO WATCHES" icon. Next, on the watch, hold down (C) for at least three seconds.



Has the watch been re-paired with the phone?

After deleting the pairing information from the CASIO WATCHES phone app and your phone, re-pair the watch and phone.
[Deleting Pairing Information from the CASIO WATCHES phone app](#)
[Pair the watch with a phone.](#)

If you are unable to establish a connection...

After deleting pairing information from the watch, re-pair it with your phone.
[Deleting Pairing Information from the Watch](#)
[Pair the watch with a phone.](#)

Changing to a Different Phone Model

Q1 Connecting the current watch to another phone.

Delete the pairing information from your watch and then pair it with the phone you want to connect with.

[If you purchase another phone](#)

Auto Time Correction by Bluetooth Connection (Time Correction)

Q1 When does the watch correct its time?

The watch connects with the phone and perform auto time correction at around 12:30 a.m., 6:30 a.m., 12:30 p.m. and 6:30 p.m. The connection is automatically terminated after auto time correction is complete.

Q2 Auto time correction is not performed at a scheduled time.

Is auto time correction not being performed according to its normal schedule?

Note that auto time correction is not performed for 24 hours after swapping of the Home Time and World Time, or after the time setting is corrected manually on the watch. Auto time correction will resume 24 hours after either of the above operations is performed.

Is auto time correction enabled?

Auto time correction is not performed at the scheduled times if it is not enabled. Enable auto time correction.
[Using the Watch in a Medical Facility or Aircraft](#)

Q3 Time is not displayed correctly.

If your phone is unable to receive a signal because you are outside its service range or for some other reason, the watch may not be able to display the correct time. If this happens, connect the phone to its network and then correct the time setting.

Q4 Hands are out of alignment.

Strong magnetism or impact can cause the hands to go out of alignment. Adjust hand alignment.

[Adjusting Hand Alignment](#)

- Check the information below to find out how to align the hands manually.
[Hand Alignment Adjustment](#)

Alarm and Hourly Time Signal

Q1 An alarm does not sound.

Is the watch's battery charged?

Keep the watch exposed to light until it recharges sufficiently.

[Charging](#)

Other than the above.

The alarm's settings may not be configured. Configure the alarm settings.

[Configuring Alarm Settings](#)

Q2 The hourly time signal does not sound.

Is the watch's battery charged?

Keep the watch exposed to light until it recharges sufficiently.

[Charging](#)

Other than the above.

The hourly time signal may be disabled. Enable the hourly time signal.

[Enabling the Hourly Time Signal](#)

Hand Movement and Indications

Q1 I don't know what mode the watch is in.

Hold down (C) for at least one second to return to the Timekeeping Mode. Use (C) to navigate between modes.

[Navigating Between Modes](#)

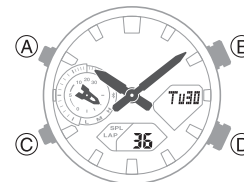

Q2 All hands are stopped and buttons do not work.

The battery is dead. Keep the watch exposed to light until it recharges sufficiently.

[Charging](#)

Q3 The hands suddenly start moving at high speed.

This is due to the reason (or one of the reasons) below, and does not indicate malfunction. Simply wait until normal hand movement resumes.

- The watch is recovering from a power saving state.
[🔗 Power Saving Function](#)
- Watch is connected with a phone to correct its time setting.
[🔗 Auto Time Correction](#)

Q4 Hands are stopped and buttons do not work.

The watch is in the charge recovery mode. Wait until the recovery process is complete (for about 15 minutes). The watch will recover more quickly if you place it in a brightly lit location.

Q5 Why is the current time indicated by the watch is off by a certain amount of time (nine hours, three hours and 15 minutes, etc.)?

The city setting is not correct. Select the correct setting.

[🔗 Setting a Home City](#)

Q6 The current time indicated by the watch is off by one hour or 30 minutes.

The summer time setting is not correct. Select the correct setting.

[🔗 Setting a Home City](#)

Q7 The time indicated by the hands is different from the digital time.

Strong magnetism or impact can cause the hands to go out of alignment. Adjust hand alignment.

[🔗 Adjusting Hand Alignment](#)

- Check the information below to find out how to align the hands manually.
[🔗 Hand Alignment Adjustment](#)

Other

Q1 I can't find the information I need here.

Visit the website below.

<https://world.casio.com/support/>

Precautions

Operating Precautions

● Water Resistance

- The information below applies to watches with WATER RESIST or WATER RESISTANT marked on the back cover.

Water Resistance Under Daily Use

Marking on watch front or on back cover	No BAR mark
---	-------------

Example of Daily Use

Hand washing, rain	Yes
Water-related work, swimming	No
Windsurfing	No
Skin diving	No

Enhanced Water Resistance Under Daily Use

5 Atmospheres

Marking on watch front or on back cover	5BAR
---	------

Example of Daily Use

Hand washing, rain	Yes
Water-related work, swimming	Yes
Windsurfing	No
Skin diving	No

10 Atmospheres

Marking on watch front or on back cover	10BAR
---	-------

Example of Daily Use

Hand washing, rain	Yes
Water-related work, swimming	Yes
Windsurfing	Yes
Skin diving	Yes

20 Atmospheres

Marking on watch front or on back cover	20BAR
---	-------

Example of Daily Use

Hand washing, rain	Yes
Water-related work, swimming	Yes
Windsurfing	Yes
Skin diving	Yes

- Do not use your watch for scuba diving or other types of diving that requires air tanks.

- Watches that do not have WATER RESIST or WATER RESISTANT marked on the back cover are not protected against the effects of sweat. Avoid using such a watch under conditions where it will be exposed to large amounts of sweat or moisture, or to direct splashing with water.

- Even if a watch is water resistant, note the usage precautions described below. Such types of use reduce water resistance performance and can cause fogging of the glass.
 - Do not operate the crown or buttons while your watch is submersed in water or wet.
 - Avoid wearing your watch while in the bath.
 - Do not wear your watch while in a heated swimming pool, sauna, or any other high temperature/high humidity environment.
 - Do not wear your watch while washing your hands or face, while doing housework, or while performing any other task that involves soaps or detergents.

- After submersion in seawater, use plain water to rinse all salt and dirt from your watch.
- To maintain water resistance, have the gaskets of your watch replaced periodically (about once every two or three years).
- A trained technician will inspect your watch for proper water resistance whenever you have its battery replaced. Battery replacement requires the use of special tools. Always request battery replacement from your original retailer or from an authorized CASIO service center.
- Some water-resistant watches come with fashionable leather bands. Avoid swimming, washing, or any other activity that causes direct exposure of a leather band to water.

- The inside surface of the watch glass may fog when the watch is exposed to a sudden drop in temperature. No problem is indicated if the fogging clears up relatively quickly. Sudden and extreme temperature changes (such as coming into an air conditioned room in the summer and standing close to an air conditioner outlet, or leaving a heated room in the winter and allowing your watch to come into contact with snow) can cause it to take longer for glass fogging to clear up. If glass fogging does not clear up or if you notice moisture inside of the glass, immediately stop using your watch and take it to your original retailer or to an authorized CASIO service center.

- Your water-resistant watch has been tested in accordance with International Organization for Standardization regulations.

● Band

- Tightening the band too tightly can cause you to sweat and make it difficult for air to pass under the band, which can lead to skin irritation. Do not fasten the band too tightly. There should be enough room between the band and your wrist so you can insert your finger.
- Deterioration, rust, and other conditions can cause the band to break or come off of your watch, which in turn can cause band pins to fly out of position or to fall out. This creates the risk of your watch falling from your wrist and becoming lost, and also creates the risk of personal injury. Always take good care of your band and keep it clean.
- Immediately stop using a band if you even notice any of the following: loss of band flexibility, band cracks, band discoloration, band looseness, band connecting pin flying or falling out, or any other abnormality. Take your watch to your original retailer or to a CASIO service center for inspection and repair (for which you will be charged) or to have the band replaced (for which you will be charged).

● Temperature

- Never leave your watch on the dashboard of a car, near a heater, or in any other location that is subject to very high temperatures. Do not leave your watch where it will be exposed to very low temperatures. Temperature extremes can cause your watch to lose or gain time, to stop, or otherwise malfunction.
- Leaving your watch in an area hotter than +60 °C (140 °F) for long periods can lead to problems with its LCD. The LCD may become difficult to read at temperatures lower than 0 °C (32 °F) and greater than +40 °C (104 °F).

● Impact

- Your watch is designed to withstand impact incurred during normal daily use and during light activity such as playing catch, tennis, etc. Dropping your watch or otherwise subjecting it to strong impact, however, can lead to malfunction. Note that watches with shock-resistant designs (G-SHOCK, BABY-G, G-MS) can be worn while operating a chain saw or engaging in other activities that generate strong vibration, or while engaging in strenuous sports activities (motocross, etc.).

● Magnetism

- The hands of analog and combination (analog-digital) watches are moved by a motor that uses magnetic force. When such a watch is close to a device (audio speakers, magnetic necklace, cell phone, etc.) that emits strong magnetism, the magnetism can cause timekeeping to slow down, speed up, or stop, resulting in the incorrect time being displayed.
- Very strong magnetism (from medical equipment, etc.) should be avoided because it can cause malfunction of your watch and damage to electronic components.

● Electrostatic Charge

- Exposure to very strong electrostatic charge can cause your watch to display the wrong time. Very strong electrostatic charge even can damage electronic components.
- Electrostatic charge may cause temporary blotching in blank areas of the LCD.

● Chemicals

- Do not allow your watch to come into contact with thinner, gasoline, solvents, oils, or fats, or with any cleaners, adhesives, paints, medicines, or cosmetics that contain such ingredients. Doing so can cause discoloration of or damage to the resin case, resin band, leather, and other parts.

● Storage

- If you do not plan to use your watch for a long time, thoroughly wipe it free of all dirt, sweat, and moisture, and store it in a cool, dry place.

● Resin Components

- Allowing your watch to remain in contact with other items or storing it together with other items for long periods while it is wet can cause color on resin components to transfer to the other items, or the color of the other items to transfer to the resin components of your watch. Be sure to dry off your watch thoroughly before storing it and make sure it is not in contact with other items.
- Leaving your watch where it is exposed to direct sunlight (ultraviolet rays) for long periods or failure to clean dirt from your watch for long periods can cause it to become discolored.
- Friction caused by certain conditions (strong external force, sustained rubbing, impact, etc.) can cause discoloration of painted components.
- If there are printed figures on the band, strong rubbing of the printed area can cause discoloration.
- Leaving your watch wet for long periods can cause fluorescent color to fade. Wipe the watch dry as soon as possible after it becomes wet.
- Semi-transparent resin parts can become discolored due to sweat and dirt, and if exposed to high temperatures and humidity for long periods.
- Daily use and long-term storage of your watch can lead to deterioration, breaking, or bending of resin components. The extent of such damage depends on usage conditions and storage conditions.

● Leather Band

- Allowing your watch to remain in contact with other items or storing it together with other items for long periods while it is wet can cause the color of the leather band to transfer to the other items or the color of the other items to transfer to the leather band. Be sure to dry off your watch thoroughly with a soft cloth before storing it and make sure it is not in contact with other items.
- Leaving a leather band where it is exposed to direct sunlight (ultraviolet rays) for long periods or failure to clean dirt from a leather band for long periods can cause it to become discolored.

CAUTION:

Exposing a leather band to rubbing or dirt can cause color transfer and discoloration.

● Metal Components

- Failure to clean dirt from metal components can lead to formation of rust, even if components are stainless steel or plated. If metal components exposed to sweat or water, wipe thoroughly with a soft, absorbent cloth and then place the watch in a well-ventilated location to dry.
- Use a soft toothbrush or similar tool to scrub the metal with a weak solution of water and a mild neutral detergent, or with soapy water. Next, rinse with water to remove all remaining detergent and then wipe dry with a soft absorbent cloth. When washing metal components, wrap the watch case with kitchen plastic wrap so it does not come into contact with the detergent or soap.

● Bacteria and Odor Resistant Band

- The bacteria and odor resistant band protects against odor generated by the formation of bacteria from sweat, which ensures comfort and hygiene. In order to ensure maximum bacteria and odor resistance, keep the band clean. Use an absorbent soft cloth to thoroughly wipe the band clean of dirt, sweat, and moisture. A bacteria and odor resistant band suppresses the formation of organisms and bacteria. It does not protect against rash due to allergic reaction, etc.

● Liquid Crystal Display

- Display figures may be difficult to read when viewed from an angle.

Note that CASIO Computer Co., Ltd. assumes no responsibility for any damage or loss suffered by you or any third party arising through the use of your watch or its malfunction.

User Maintenance

● Caring for Your Watch

Remember that you wear your watch next to your skin, just like a piece of clothing. To ensure your watch performs at the level for which it is designed, keep it clean by frequently wiping with a soft cloth to keep your watch and band free of dirt, sweat, water and other foreign matter.

- Whenever your watch is exposed to sea water or mud, rinse it off with clean fresh water.
- For a metal band or a resin band with metal parts, use a soft toothbrush or similar tool to scrub the band with a weak solution of water and a mild neutral detergent, or with soapy water. Next, rinse with water to remove all remaining detergent and then wipe dry with a soft absorbent cloth. When washing the band, wrap the watch case with kitchen plastic wrap so it does not come into contact with the detergent or soap.
- For a resin band, wash with water and then wipe dry with a soft cloth. Note that sometimes a smudge like pattern may appear on the surface of a resin band. This will not have any effect on your skin or clothing. Wipe with a cloth to remove the smudge pattern.
- Clean water and sweat from a leather band by wiping with a soft cloth.
- Not operating a watch crown, buttons, or rotary bezel could lead to later problems with their operation. Periodically rotate the crown and rotary bezel, and press buttons to maintain proper operation.

● Dangers of Poor Watch Care

Rust

- Though the metal steel used for your watch is highly rust-resistant, rust can form if your watch is not cleaned after it becomes dirty.
 - Dirt on your watch can make it impossible for oxygen to come into contact with the metal, which can lead to breakdown of the oxidization layer on the metal surface and the formation of rust.
- Rust can cause sharp areas on metal components and can cause band pins to fly out of position or to fall out. If you ever notice any abnormality immediately stop using your watch and take it to your original retailer or to an authorized CASIO service center.
- Even if the surface of the metal appears clean, sweat and rust in crevasses can soil the sleeves of clothing, cause skin irritation, and even interfere with watch performance.

Premature Wear

- Leaving sweat or water on a resin band or bezel, or storing your watch in an area subject to high moisture can lead to premature wear, cuts, and breaks.

Skin Irritation

- Individuals with sensitive skin or in poor physical condition may experience skin irritation when wearing a watch. Such individuals should keep their leather band or resin band particularly clean. Should you ever experience a rash or other skin irritation, immediately remove your watch and contact a skin care professional.

Battery

- The special rechargeable battery used by your watch is not intended to be removed or replaced by you. Use of a rechargeable battery other than the special one specified for your watch can damage your watch.
- The rechargeable (secondary) battery is charged when the solar panel is exposed to light, so it does not require regular replacement as the primary battery requires. Note, however, that long use or operating conditions can cause the capacity or charging efficiency of the rechargeable battery to deteriorate. If you feel that the amount of operation provided by charging is too short, contact your original retailer or CASIO service center.

Mobile Link Precautions

● Legal Precautions

- This watch complies with or has received approval under the radio laws of various countries and geographical areas. Using this watch in an area where it does not comply with or has not received approval under applicable radio laws may be a criminal offense. For details, visit the CASIO Website.

<https://world.casio.com/ce/BLE/>

- Use of this watch inside of aircraft is restricted under the aviation laws of each country. Be sure to follow the instructions of airline personnel.

● Precautions when using Mobile Link

- When using this watch in combination with a phone, keep the watch and phone close to each other. A range of two meters is recommended as a guideline, but the local environment (walls, furniture, etc.), the structure of a building, and other factors may require a much closer range.
- This watch can be affected by other devices (electrical devices, audio-visual equipment, office equipment, etc.) In particular, it can be affected by operation of a microwave oven. The watch may not be able to communicate normally with a phone if a microwave oven is operating nearby. Conversely, this watch may cause noise in radio reception and the video image of a TV.
- Bluetooth of this watch uses the same frequency band (2.4 GHz) as wireless LAN devices, and use of such devices in close proximity of this watch may result in radio interference, slower communication speeds and noise for the watch and the wireless LAN device, or even communication failure.

● Stopping Radio Wave Emission by This Watch

The watch is emitting radio waves whenever the function hand is pointing to .

In addition, the watch also connects to your phone automatically four times a day to adjust its time setting.

When in a hospital, on an aircraft, or in any other area where the use of radio waves is not allowed, use the operation below to stop radio wave generation.

- Stopping Radio Wave Generation

Press any button to terminate the Bluetooth connection.

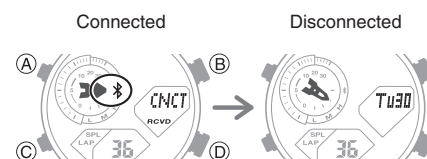

- Disabling Auto Time Correction
Configure CASIO WATCHES phone app settings to disable synchronization between the watch and phone.

 [Using the Watch in a Medical Facility or Aircraft](#)