



SEIKO
ManualsLib.com
TV WATCH

T001/INSTRUCTION MANUAL

PREFACE

Congratulations! You now own a SEIKO TV WATCH, one of the most unique personal accessories available today. In order to obtain the best performance from this product, read this instruction booklet carefully. A few minutes wisely invested now, will pay off in long service and hours of viewing pleasure!

The SEIKO TV WATCH is a wristwatch with a built-in TV screen. You can carry it with you and watch TV programs at any time.

The TV screen employs a liquid crystal video display (LVD) in which pictures appear in response to external light. This means that the brighter the light, the clearer the pictures will be. (You cannot watch the TV in complete darkness.) Because the headphone cord also functions as a line antenna, it can be readily adjusted until the best reception is obtained.

In addition to VHF and UHF TV programs, the TV WATCH also receives FM stereo broadcasts.

Features

- * High definition TV screen for clear pictures.
- * The brighter the viewing environment, the better the picture.
- * Compact and lightweight design plus minimal power consumption.
- * Separate wrist TV, receiver, and headphone set are provided for comfort, portability, and enhanced sound quality.
- * The watch functions include time, calendar display, alarm, and stopwatch.

TABLE OF CONTENTS

THE TV WATCH	1
Carrying the TV WATCH.....	1
Components.....	2
HOW TO OPERATE THE TV WATCH	3
Installing the batteries.....	3
Receiver controls and functions.....	4
Headphones.....	5
Watching television.....	5
Operational procedure.....	6
Listening to the TV (sound only).....	7
How to remove the video connector.....	7
Notes on operation.....	8
Listening to FM radio.....	9
Operational procedure.....	9
Notes on operation.....	9
Accessories.....	10
Optional AC adapter.....	10
Earphone listening.....	10
Using the watch.....	11
Display and button operation.....	11
Time and calendar.....	13
Stopwatch.....	14
Alarm setting.....	15
Testing the alarm.....	16
Changing the "beeper" modes.....	16
The battery.....	16

TIPS ON OPERATION	17
CARING FOR THE TV WATCH	20
PRECAUTIONS	21
General.....	21
Extremely high temperatures.....	21
Extremely low temperatures.....	21
Water and humidity.....	22
Chemicals.....	22
Shocks.....	22
Magnetism.....	22
Batteries.....	22
SI ECIFICATIONS	23

THE TV WATCH



Headphones

Can be used to listen to TV or FM stereo broadcasts.

ManualsLib.com

The illustration shows the proper way to carry the TV WATCH. The receiver may be carried in a breast pocket, shoulder bag, purse, or belt pouch. It is recommended that the video connector cord be worn inside of a sleeve to prevent it from catching on foreign objects.

Note:

To prevent the cords from becoming tangled, they may be fastened together for part of their length using the provided cord clips.



Power switch

Tuning dial

Tuning scale

Volume control dial

TV/FM selection switch

Band selection switch

Headphone cord

Transmits audio signals from the receiver to the headphones and functions as a line antenna.

DC jack



Receiver

Covers all TV frequencies and receives FM broadcasts.

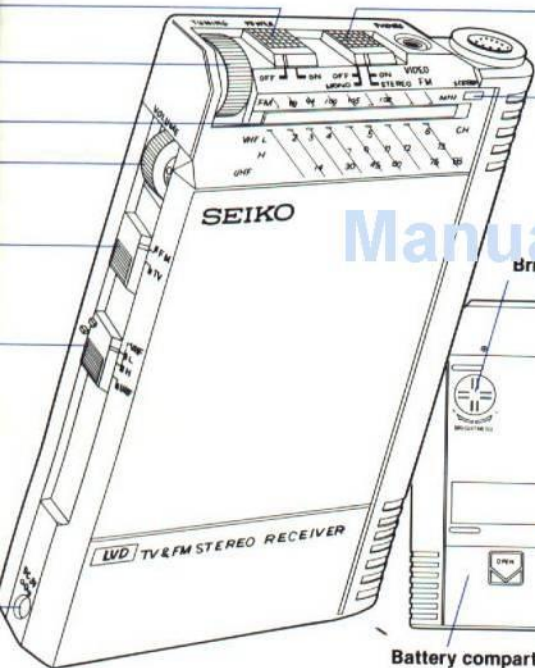

Video switch

Stereo indicator

Lights up when FM stereo broadcasts are being received.

Brightness control knob (on the back side)

Battery compartment (on the back side)



Video connector

Transmits video signals from the receiver to the wrist terminal.

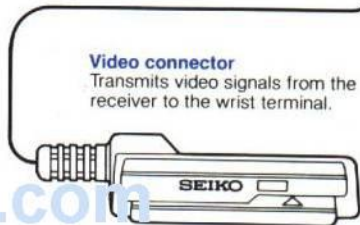

Wrist TV

Provides both video display (LVD) and watch function (LCD).

Time/calendar display

TV screen



ManualsLib.com

Installing The Batteries

The receiver is powered by two "AA" (IEC designation R6) batteries. They are installed as follows:

- (1) Remove the battery compartment lid on the back side of the receiver by sliding it in the direction of the arrow.
- (2) Insert two "AA" size batteries into the compartment, matching the polarity of the + and - signs (see illustration). Make sure that the upper one is inserted first, but do not push down too hard. (Remember to place the ribbon under the batteries to facilitate easy removal.)
- (3) Close the lid by sliding it along the grooves on both sides of the compartment until it snaps shut.

Important

The two alkaline "AA" batteries which power the receiver should last approximately five hours (two hours with manganese batteries). When the TV flickers or becomes dark, or when the sound track becomes static, or when the picture does not appear while there is sound, it is time to replace the batteries. Always replace both batteries at the same time.

(A) Video switch (Combined with the stereo/monaural selection switch)

- * With the TV/FM selection switch set to TV:
Slide the switch to the "ON" position and the picture comes on the TV screen.
Slide the switch to the "OFF" position and the picture disappears from the screen.
- * With the TV/FM selection switch set to FM:
Slide the switch to the "STEREO" position and FM programs are received in stereo.
Slide the switch to "MONO" and the FM programs are received in monaural.

(B) Power switch (POWER)

- Slide the switch to the "OFF" position to turn off the power.
- Slide the switch to the "ON" position to turn on the power.

HOW TO OPERATE THE TV WATCH

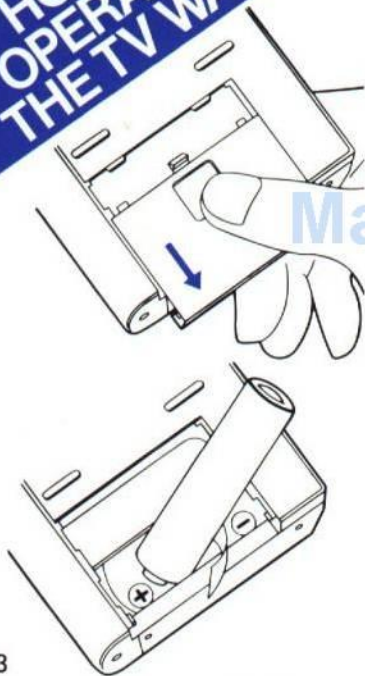

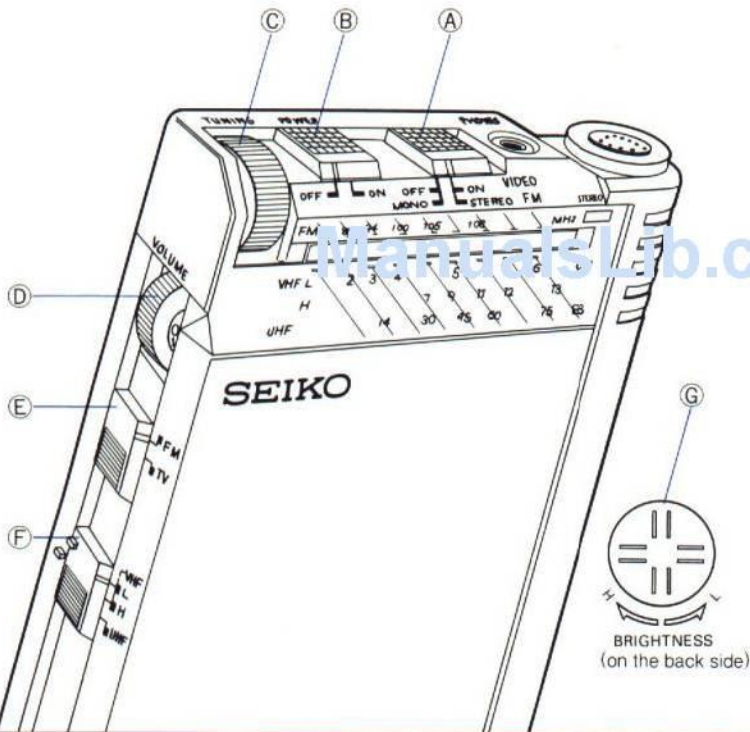

- C Tuning dial**
(CHANNEL SELECTION)
Rotate the tuning dial to select the desired channel.
- D Volume control dial** (VOLUME)
The volume can be controlled by rotating the dial. The higher the number, the louder the volume.
- E TV/FM selection switch**
Slide the switch to "FM" for FM reception.
Slide the switch to "TV" for TV reception.
- F Band selection switch**
Slide the switch to "L" to select VHF Ch. 2-6.
Slide the switch to "H" to select VHF Ch. 7-13.
Slide the switch to "U" to select UHF Ch. 14-83.
- G Brightness control knob**
(BRIGHTNESS)
Turn the knob on the back of the receiver clockwise, and the TV screen becomes brighter.
Turn the knob counterclockwise, and the TV screen becomes darker.

Operational Procedure

- ① Insert the headphone plug into the headphone jack and put on the headphones.
- ② Insert the video connector into the video jack by aligning the blue-colored dots.
- ③ Fasten the video connector to the wrist terminal. When properly set it clicks into position. (Make sure that the power switch is turned to the "OFF" position.)
 - * If the contacts on the wrist terminal become dirty, wipe them off with a soft cloth or tissue.
- ④ After checking that the volume control dial is set to "1~2," slide the power switch to the "ON" position.
- ⑤ Slide the TV/FM selection switch to the "TV" position.
- ⑥ Slide the band selection switch to select the desired channel frequency range.
- ⑦ Slide the video switch to the "ON" position.



- * This switch has two functions. It serves as a video ON/OFF selector, as well as a STEREO/MONO selector. However, all TV programs are received in monaural.
 - * When not in use, slide the video switch and the power switch to "OFF."
- ⑧ To select the desired channel, rotate the tuning dial using the tuning scale as a guide. Once you have found a channel, fine tune it while watching the TV screen.
 - ⑨ Turn the volume control dial to control the volume level.
- * Brightness can be adjusted by turning the control knob on the back of the receiver. The higher the setting, the brighter the picture. (For most situations, the central position is best.)

Listening to the TV (sound only)

Turn the video switch to the "OFF" position or remove the video connector from the receiver side (which helps economize on power).

How to remove the video connector from THE RECEIVER:

Hold the plug firmly between your fingers and pull it straight up and out of the receiver (see illustration below left).

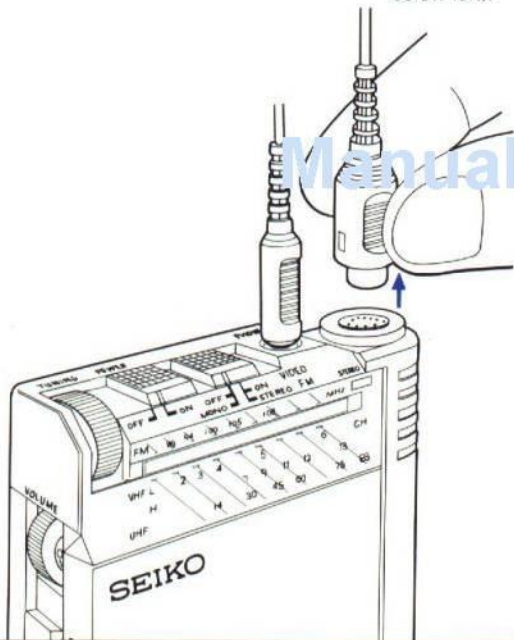

from THE WRIST TV:

Hold the wrist TV in your hand and press the arrow-marked position on the wrist plug with your thumb (see illustration below).

Never pull the wrist plug off by the cord.

Note:

Make sure that the video connector is either removed from the receiver or that the video switch is turned to OFF. If the video connector is only removed from the wrist terminal and the video switch left ON, there is a possibility of circuit damage.

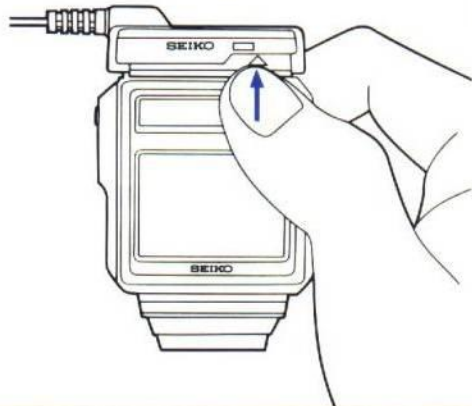

Notes on Operation

1. Television broadcasts are only received in monaural. The TV WATCH is not capable of receiving multiplex broadcasts.
2. The headphone cord functions as a line antenna. Therefore:
 - * Reception quality may vary due to changes in the antenna position.
 - * Stretch the cord as long as possible for optimum reception.
3. Watch the TV in places where good reception can be obtained. Avoid places where radiowaves do not penetrate or reception is weak. These include:
Subways, underground locations, "valleys" between tall buildings, and areas enclosed by mountains.



4. Enjoy watching TV in bright places.
 - * Unlike an ordinary CRT TV screen, the LCD screen on the TV WATCH will produce the best images in bright light.
 - * Although you cannot use the TV WATCH in complete darkness, it will function adequately in any place where there is enough ambient light to read a book.
 - * To prevent eyestrain, do not use the TV WATCH in extremely bright places (direct sunlight, etc.) or in marginal light for long periods of time.

*In case of difficulty,
refer to "Tips on Operation," P. 17.*

Operational Procedure

- ① Insert the headphone plug into the headphone jack and put on the headphones.
- ② After checking that the volume control dial is set at "1-2," slide the power switch to "ON."
- ③ Slide the TV/FM selection switch to "FM."
- ④ Slide the stereo/monaural selection switch to the desired position. (refer to "Notes on Operation")
- ⑤ To select the desired FM channel, rotate the tuning dial, using the tuning scale as a guide, while listening to the headphones.
* The stereo indicator will come on when a stereo broadcast is being received.
- ⑥ Turn the volume control dial to adjust the volume level.

Notes on Operation

1. The tuner of the TV WATCH is able to receive FM stereo broadcasts. However, if the sound track you are listening to contains static, set the stereo/monaural selection switch to MONO to help improve the clarity. In addition, make sure that the headphone cord is stretched to its full length.
2. For earphone listening, set the selection switch to MONO.

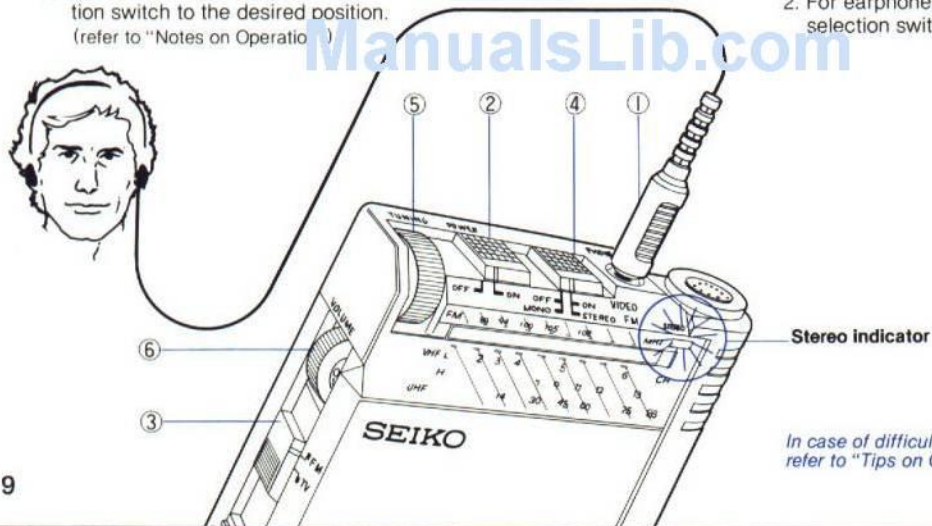

*In case of difficulty,
refer to "Tips on Operation," P. 17.*

Optional AC Adapter

To power your TV WATCH from an ordinary wall outlet, an optional AC adapter is required. It may be used as follows:

1. Insert the AC adapter plug into the DC jack of the receiver.
2. Plug the AC adapter into the wall outlet. The receiver is now powered by AC current, even if the batteries are loaded in the compartment.
3. To resume battery operation, remove both the AC adapter from the wall outlet and the plug from the receiver.

Important:

- * Use only the optional SEIKO AC adapter. Otherwise malfunctions may occur due to differences in polarity, voltage, and adapter characteristics.
- * Do not set the receiver next to the AC adapter when using the TV WATCH because it may cause sound track interference.
- * Touching the AC adapter with wet hands may cause an electrical shock.
- * Do not place heavy objects on the AC adapter cord because it may damage the insulation and distort the cord's

Earphone listening

You may also listen to the FM radio or television sound track by using an ordinary earphone.

Make sure to set the stereo/monaural selection switch to MONO.

Note:

The optimal length of the earphone cord is approximately 1 - 1.2m.

Carrying Pouch

A carrying pouch is available so you can wear the receiver comfortably on your belt.

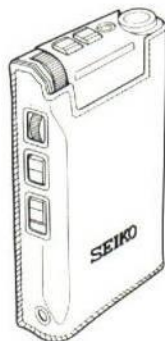
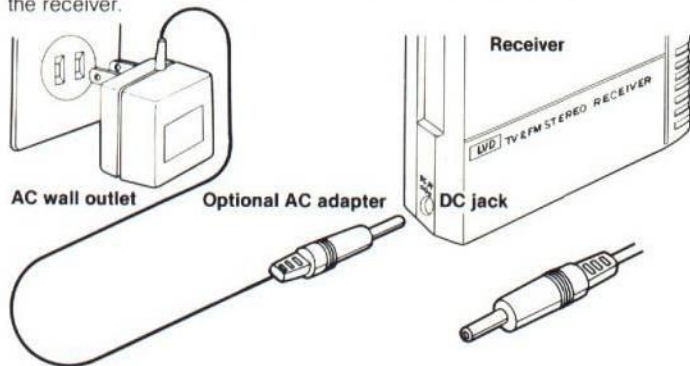

Stopwatch

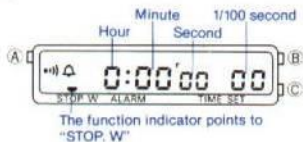

Button (B): Start/stop

The "STOP" mark is displayed when the stopwatch is stopped.

Button (C): Split/split release/reset

The "SPLIT" mark is displayed and the second mark starts flashing when split time is measured.

Depress button (A)

Alarm setting mode

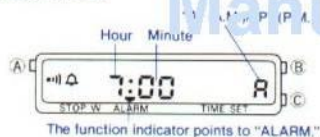

Button (B): Selects the digits to be adjusted.

Button (C): Sets the digits.

- * The display will return automatically to the time and calendar display after 1 to 2 minutes if the watch is left untouched.

Depress button (A)

Time and calendar setting mode

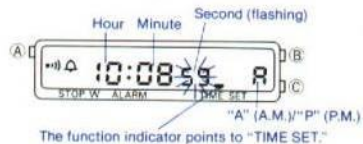

Button (B): Selects the digits to be adjusted.

Button (C): Sets the digits.

- * The display will return automatically to the time and calendar display after 1 to 2 minutes if the watch is left untouched.

Time and Calendar

Follow the operational procedure described below in numerical order.

1. Depress button (A) to activate the time and calendar setting mode.

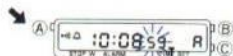

The function indicator points to "TIME SET," and the second digits start flashing.

The "24H" mark is displayed in the 24 hour indication.



2. Depress button (B) to select the digits to be adjusted, and they start flashing. The digits to be adjusted can be selected in the order shown below by depressing button (B).

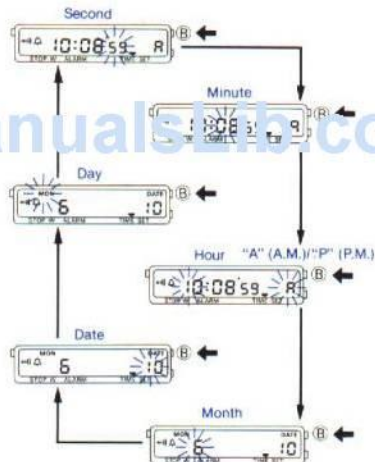

3. One digit is advanced with each depression of button (C). The digits can be rapidly advanced by keeping button (C) depressed.
4. After all adjustments are completed, depress button (A) to return to the time and calendar display.

* The display will return automatically to the time and calendar display after 1~2 minutes if the watch is left untouched.

Stopwatch

Follow the operational procedure described below.

- Depress button (A) to activate the stopwatch mode.

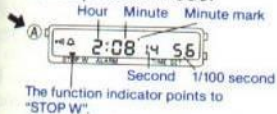

- Depress button (B) to stop stopwatch measurement.

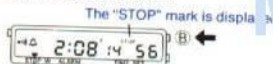

• If the "STOP" mark is displayed, this operation is not necessary.

- Depress button (C) to reset the digits to "0:00.00."

* When split time is displayed, depress button (C) twice to reset the digits to "0:00.00."

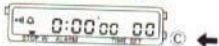

* When measuring a long period of time, it is advisable to return to the time and calendar display after the stopwatch starts counting to help avoid operational mistakes.

Standard stopwatch measurement (ex. 100-meter race)



Accumulated elapsed time measurement (ex. basketball)

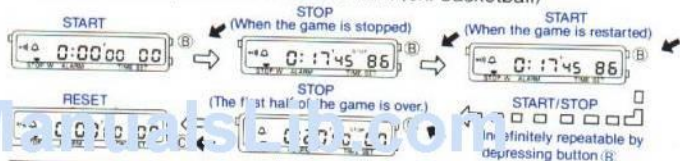

Split time measurement (ex. marathon)



Continuous time measurement of two competitors (ex. 200-meter race)



Alarm Setting

Follow the operational procedure described below.

1. Depress button (A) to activate the alarm setting mode.

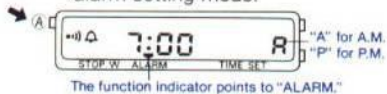

2. Depress button (B) to select the digits to be adjusted, and they start flashing. The digits to be adjusted can be selected sequentially in the following order by depressing button (B).

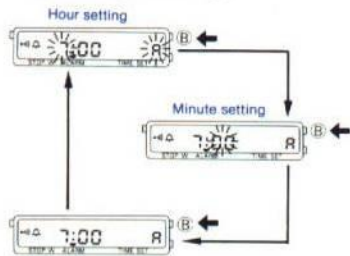

3. One digit is advanced with each depression of button (C). The digits can be rapidly advanced by keeping button (C) depressed.
 4. After all adjustments are completed, depress button (A) to return to the time and calendar display.
- * The display will return automatically to the time and calendar display after 1 ~ 2 minutes if the watch is left untouched.

HOW TO STOP THE ALARM

The alarm can be stopped by depressing button (A), (B) or (C).



- * The alarm rings for 20 seconds. For the first 10 seconds, it beeps twice a second, and for the latter 10 seconds, four times a second.

Testing The Alarm

When the watch is in the time/calendar mode, the alarm can be tested by simultaneously depressing buttons (B) and (C).

Note:

Alarm time is displayed when both buttons are depressed and held.

Changing the "Beeper" Modes

When the watch is in the time/calendar mode, the beeper modes can be changed by simultaneously depressing buttons (B) and (C). Four modes are available: alarm only, hourly time signal only, alarm and hourly time signal, and off.

Note:

Alarm time is displayed when both buttons are depressed and held.

The following chart illustrates the beeper modes sequence.

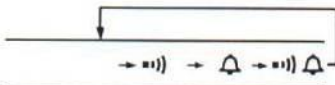

Alarm	OFF	ON	OFF	ON
-------	-----	----	-----	----

Hourly time signal	OFF	OFF	ON	ON
--------------------	-----	-----	----	----

Battery Life Indicator

If the watch display begins to flicker, it means the battery is almost exhausted. (The time function will remain accurate.) Take the watch to your SEIKO dealer for battery replacement.

Battery Replacement





The silver oxide battery (Maxell SR920W) which powers your watch should last approximately two years. However, because it is inserted at the factory, the actual life of the battery from the time you purchase the TV WATCH may be shorter than the specified period. When the battery is exhausted, be sure to replace it with an authorized SEIKO battery as soon as possible to prevent any possible malfunction. When replacing the battery, we recommend that you contact an authorized SEIKO dealer.





Note:

If the alarm is used more than 20 seconds a day, the battery life may be less than the specified period.

TV FUNCTIONS

Before consulting your dealer, see if you can solve any difficulties that might occur by referring to the following tips.

Problem	Possible cause	Solution	
	A picture does not appear in the screen and there is no sound.	<ul style="list-style-type: none"> * Weak batteries: * Batteries improperly inserted. * Power switch not turned on. * AC adapter not securely connected. 	<ul style="list-style-type: none"> * Replace the old batteries with new ones. * Remove the batteries and insert them properly. * Turn the power switch on. * Plug the adapter firmly into the outlet.
	There is sound but no picture. When the video switch is turned on, the sound is cut off.	* Weak batteries.	* Replace the old batteries with new ones.
	Sound is clear, but a picture does not appear in the screen.	<ul style="list-style-type: none"> * Video connector is not firmly connected. * Video switch is turned off. * Weak batteries. 	<ul style="list-style-type: none"> * Plug the video connector firmly into the receiver. * Turn the video switch on. * Replace the old batteries with new ones.
	A picture appears in the screen but there is no sound.	<ul style="list-style-type: none"> * Volume control is turned down to the lowest level. * Headphone plug is only partially inserted. 	<ul style="list-style-type: none"> * Set the volume control to the proper level. * Check the connection between the headphone plug and jack.

	Problem	Possible cause	Solution
	Picture quality becomes distorted but the sound remains clear.	<ul style="list-style-type: none"> * Headphone cord is tangled. * Reception is weak. 	<ul style="list-style-type: none"> * Stretch the headphone cord. * Watch the TV WATCH in places where good reception can be obtained.
	The picture drifts but the sound remains clear.	<ul style="list-style-type: none"> * Receiver is not properly tuned. * Headphone cord is tangled. * Reception is weak. 	<ul style="list-style-type: none"> * Tune the receiver by adjusting the tuning control dial. * Stretch the headphone cord. * Watch the TV WATCH in places where good reception can be obtained.
	Double or triple images appear but the sound remains clear.	<ul style="list-style-type: none"> * Interference from mountains or tall buildings. 	<ul style="list-style-type: none"> * Stretch the headphone cord or move the unit to a location with better reception.
	A blue band appears on the screen but the sound remains clear.	<ul style="list-style-type: none"> * Weak batteries. 	<ul style="list-style-type: none"> * Replace the old batteries with new ones.

RADIO FUNCTIONS

Problem	Possible cause	Solution
No sound	<ul style="list-style-type: none">* Weak batteries.* Batteries are improperly inserted.* Power switch is turned off.* Headphone plug is only partially inserted.* Volume control is turned down to the lowest level.* AC adapter is not securely connected.	<ul style="list-style-type: none">* Replace the old batteries with new ones.* Remove the batteries and insert them properly.* Turn the power switch on.* Check the connection between the headphone plug and jack.* Adjust the volume level.* Plug the adapter firmly into the outlet.
Interference when listening to FM stereo broadcasts.	<ul style="list-style-type: none">* Poor conditions for FM stereo reception because of remote location.	<ul style="list-style-type: none">* Set the stereo/monaural selection switch to MONO.
Stereo indicator flickers and there is interference when listening to FM stereo broadcasts.	<ul style="list-style-type: none">* Receiver is not properly tuned.* Headphone cord is tangled.	<ul style="list-style-type: none">* Tune the receiver using the tuning dial.* Stretch the headphone cord.
Crosstalk occurs when listening to stereo broadcasts.	<ul style="list-style-type: none">* A slight amount of crosstalk is liable to occur under normal conditions.	<ul style="list-style-type: none">* This should not be considered a malfunction unless the level of crosstalk becomes unacceptable. In that case, consult your SEIKO dealer.

CARING FOR THE TV WATCH

By observing the following points you can preserve the quality of your TV WATCH.

Periodic checks

Have your TV WATCH checked by an authorized SEIKO dealer every time the battery is replaced or once every two or three years. This will ensure that the case, buttons, crown, gasket, and crystal seal remain intact. At this time, your SEIKO dealer will also check for electrical leakage, moisture penetration, and will lubricate the unit.

Caring for the case and bracelet

Excessive dust and moisture on the case and the bracelet may cause rust. To prevent such deterioration, periodically wipe the case and bracelet with a soft, absorbent cloth.

Caring for the receiver

If the receiver becomes stained or dirty, wipe it with a cloth slightly moistened in soapy water, then dry it with a dry cloth.

PRECAUTIONS

General

- * For your safety, and the safety of others, do not watch or listen to the TV WATCH while driving a motor vehicle.
- * Be sure to adjust the volume properly. Listening to the headphones at too high a volume may damage your hearing.
- * Because the headphones are an open-air type, excessive volume may also disturb those close to you.
- * Do not attempt to disassemble the receiver, otherwise damage may occur.
- * Handle the video connector and video jack carefully, and avoid damage to the contacts on the wrist terminal.
- * Because the surface of the TV screen is covered with a special coating, do not hit it against anything hard. If it becomes badly stained, wipe it with a soft cloth.
- * Do not insert foreign objects into the DC jack, the headphone jack, or the video jack.

Extremely high temperatures

- * Avoid direct sunlight or hot places. If the TV WATCH is placed in such an environment, the time display section may become dark and the TV screen turn to light blue. However, both will function properly again when the temperature returns to normal.
- * Make sure that the video connector and the headphone cord are kept away from high temperatures, i.e. heating apparatus.
- * Extremely high temperatures may also cause electrolyte leakage or shorten battery life.

Extremely low temperatures

- * Do not leave the TV WATCH in a cold place for a long time.
- * Extreme cold may cause the watch to gain or lose small amounts of time. In addition, the digital display may become sluggish.

ManualLib.com

- * Extreme cold may cause the pitch of the alarm to become lower. Moreover, the battery life indicator may come on while the alarm is ringing.
- * Extremely low temperatures may also cause electrolyte leakage or shorten battery life.

Water and Humidity

- * Because the TV WATCH is not water-resistant, avoid exposing it to water (including rain or snow) or large amounts of perspiration. If the unit accidentally gets wet, wipe it with a soft, absorbent cloth.
- * Because there is a small amount of moisture inside the watch, the glass surface will cloud up with steam when the external temperature becomes lower than that inside the watch. If this condition lasts for a long time, consult your dealer.
- * The unit is not affected by normal amounts of moisture, perspiration or dust. However, avoid pressing the buttons with wet or stained hands.

Chemicals

- * Avoid contact with chemicals that might alter the appearance or function of the TV WATCH. These include mercury (for example, a broken thermometer), insecticides, and solvents such as benzine, alcohol, and thinner.

Shocks

- * Normal activity, including light sports, will not affect the TV WATCH. Do not carelessly drop the unit or hit it against anything hard.

Magnetism

- * The TV WATCH is not affected by magnetism.

Batteries

Incorrect use of the batteries may cause damage due to leakage and corrosion. To avoid such trouble and preserve battery life, observe the following rules.

- * Always insert the batteries in the compartment as illustrated in the polarity diagram.
- * Always replace *both* batteries at the same time. Never mix new and old batteries.
- * Battery voltage and type may differ despite similarities in design and shape. Always make sure that only the specified batteries are used in the receiver.
- * If the set will not be used for a long period of time, or if you plan to operate it extensively via the AC adapter, remove the batteries to avoid the risk of damage caused by leakage or corrosion.
- * If the batteries are weak, replace them as soon as possible. Otherwise there is a risk of damage due to leakage.

SPECIFICATIONS

Receiver section

Receiving channels.....	FM MPX 88~108MHz VHF 2~13ch UHF 14~83ch
Power source.....	Two "AA"-size batteries (IEC designation R6) AC home outlet for TV via optional AC adapter
Power consumption.....	Approx. 520mW Approx. 360mW (sound only)
Battery life..... (2 "AA" batteries)	Alkaline/manganese batteries— approx. 5 hours (TV) and 10 hours (sound only) Manganese batteries—approx. 2 hours (TV) and 4 hours (sound only)
Output terminal.....	Video jack, headphone jack (stereo mini jack with a load impedance of 16~32 ohms)
Operating temperature range.....	0°C~50°C (32°F~122°F)
Weight.....	Approx. 140g (without batteries and accessories)
Dimensions.....	74.5mm(W)×125.0mm(H)× 19.0mm(D)
Accessories.....	Stereo headphone set×1, video connector×1, carrying pouch×1, and alkaline manganese battery×2

ManualsLib.com

Wrist TV section

Oscillation frequency	32,768 Hz
Accuracy	±10 sec. a month (handling, 5°C~35°C or 41°F~95°F)
Operating temperature.....	Time function: -10°C~60°C (14°F~140°F) Time display function: 0°C~50°C (32°F~122°F) TV display function: 0°C~50°C (32°F~122°F)
Display	TV display section—TV programs Time display—time and calendar
Display elements.....	TV display—TFT guest-host liquid crystal Time display—nematic liquid crystal
Display size	TV display—16.8 mm(V)× 25.2 mm(H) Time display—4.7 mm(V)× 25.0 mm(H)
Battery..... (for watch)	Silver oxide battery (Maxell SR920W)
Battery alarm indicator.....	The entire section of the time and calendar display flickers.

*Specifications are subject to change without notice.

ManualsLib.com

SEIKO