

# ***TECHNICAL INFORMATION*** ***INFORMACION TECNICA***

---

**CITIZEN QUARTZ**  
**Cal. No. E810**



 **CITIZEN**  
CITIZEN IS A REGISTERED TRADEMARK OF CITIZEN WATCH CO., JAPAN.

## Contents

§1. FEATURES .....	1
§2. SPECIFICATIONS .....	1
§3. BEFORE USING .....	2
§4. NAMES OF COMPONENTS .....	2
§5. FUNCTIONS UNIQUE TO SOLAR-POWERED WATCHES .....	3
§6. GENERAL REFERENCE FOR CHARGING TIMES .....	5
§7. NOTES REGARDING HANDLING OF THIS WATCH .....	5
§8. REPLACING THE SECONDARY BATTERY .....	6
§9. SWITCHING THE MODE (DISPLAY FUNCTION) .....	6
§10. HAND 0-POSITION CHECK AND CORRECTION .....	6
§11. SETTING THE TIME AND DATE .....	7
§12. USING THE CHRONOGRAPH .....	9
§13. SETTING LOCAL TIME .....	10
§14. USING THE ALARM .....	11
§15. ALL RESET .....	12
§16. PRECAUTIONS FOR DISASSEMBLY AND ASSEMBLY .....	13
How To Pull Out Setting Stem from One-piece Case .....	13
Precautions for Removal and Setting of Solar Cell .....	14
Assembly of Parts Around Calendar .....	15
Hot to fit hands .....	16
§17. DISASSEMBLY AND ASSEMBLY OF MOVEMENT .....	17
Arrangement of wheels .....	18
§18. TROUBLESHOOTING AND ADJUSTMENT METHOD .....	20

## ESPAÑOL

### Índice

§1. CARACTERÍSTICAS .....	27
§2. ESPECIFICACIONES .....	27
§3. ANTES DE USAR EL RELOJ .....	28
§4. NOMBRES DE LOS COMPONENTES .....	28
§5. FUNCIONES ÚNICAS A LOS RRELOJES ENERGIZADOS POR ENERGÍA SOLAR .....	29
§6. REFERENCIA GENERAL PARA LOS TIEMPOS DE CARGAS .....	31
§7. NOTAS EN RELACIÓN A LA MANIPULACIÓN DE ESTE RELOJ .....	32
§8. REEMPLAZANDO LA BATERÍA SECUNDARIA .....	32
§9. CAMBIANDO EL MODO (FUNCIÓN DE PRESENTACIÓN) .....	32
§10. VERIFICACIÓN Y CORRECCIÓN DE LA POSICIÓN 0 DE LAS MANECILLAS .....	33
§11. AJUSTANDO LA HORA Y FECHA .....	34
§12. USANDO EL CRONÓGRAFO .....	36
§13. AJUSTANDO LA HORA LOCAL .....	37
§14. USANDO LA ALARMA .....	38
§15. REPOSICIÓN COMPLETA .....	39
§16. PRECAUCIONES PARA EL DESMONTAJE Y MONTAJE .....	40
Forma de extraer el vástago de ajuste de una caja monopieza .....	40
Precauciones para la extracción y la colocación de la célula solar .....	41
Ensamblaje de las piezas alrededor del calendario .....	42
Forma de fijar las manecillas .....	43
§17. DESMONTAJE Y MONTAJE DEL MECANISMO .....	44
Disposición de las ruedas .....	45
§18. MÉTODO DE INSPECCIÓN DE AJUSTE DEL MÓDULO .....	47

## §1. FEATURES

This watch is a solar-powered watch that contains a solar cell in its face that drives the watch by converting light energy into electrical energy. It is equipped with numerous functions including a full-auto calendar that changes the date automatically (day, month and year change automatically through February 28, 2100 including leap years), a daily alarm function that can be set based on a 24-hour clock, and a chronograph function that allows measurement of time in 1/20 second units up to 59 minutes, 59.95 seconds.

## §2. SPECIFICATIONS

Caliber NO.		E810
Type		Analog solar-power watch
Movement size (mm)		ø29.7 x 4.2t
Accuracy		Within ±15 seconds per month on average (When worn at normal temperatures of 5°C to 35°C/41°F to 95°F)
IC		1 unit of C/MOS-LSI
Operating temperature range		Watch operating temperature range: -10°C to +60°C/14°F to 140°F
		Power save feature operating temperature range: -10°C to +35°C/14°F to 95°F
		Time correction operating temperature range: -5°C to +60°C/23°F to 140°F
Converter		Bipolar step motor, 3 units
Time adjustment		No adjustment terminal for use in market
Measurement gate		10 sec.
Display function	Time	24 hours, Hour, Minute, Second
	Calendar	Date display by a date wheel (with continuous advance function) Month display by second hand Year display by function hand (years elapsed from most recent leap year)
Additional functions		Power save feature
		Insufficient recharging warning feature
		Time setting warning feature
		Overcharging prevention feature
		Chronograph (60 minute measurement, 1/20th second units)
		Local time (time difference correction: 1 hour units)
Secondary battery		Alarm (24 hour clock, alarm monitor, alarm ON/OFF)
		Part No. 295-40
Continuous operating time		Fully charged to stopping: Approx. 9 months (while in operation of power save feature) 2-second interval movement to stopping: Roughly 5 days (roughly 2 days in the case the hands have been moved to switch the time when the insufficient charging warning feature is activated)

\* Specifications are subject to change without notice.

### §3. BEFORE USING

This watch is a solar-powered watch.

Before using this watch, expose its solar cell to light sufficiently to charge its secondary battery.

If this watch has stopped running because of insufficient charge of this secondary battery, recharge this battery by exposing the solar cell to strong light such as the sunlight.

A secondary battery is used in this watch to store electrical energy. This secondary battery is a clean energy battery that does not contain mercury or other toxic substances. Once fully charged, the watch will continue to run for about 9 months without additional charging (when the power save feature is operating).

#### ☆ Power Save Feature

When power generation stops as a result of light not shining on the solar cell during the time display or local time display, the second hand stops at the 12:00 position and only the hour and minute hands move to save power. When light once again begins to shine on the solar cell, the second hand advances rapidly to the current seconds and returns to moving at one second intervals. If light (several tens of luxes) does not shine on the solar cell for continuous 15 seconds (this period depends on the design, however) and the second hand comes to the 12:00 position, the watch enters the power save mode.

#### <How to Use This Solar-Powered Watch Properly>

To use this watch comfortably, make sure to recharge it before it stops running completely. Since there is no risk of overcharging (Overcharging Prevention Feature), it is recommended that the watch be recharged everyday.

### §4. NAMES OF COMPONENTS

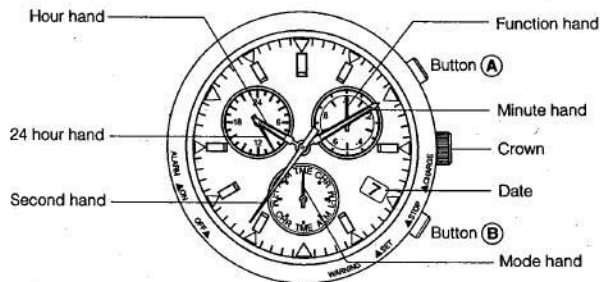

## §5. FUNCTIONS UNIQUE TO SOLAR-POWERED WATCHES

When the watch becomes insufficiently charged, the following warning features will be activated to inform the wearer that the watch is insufficiently charged.

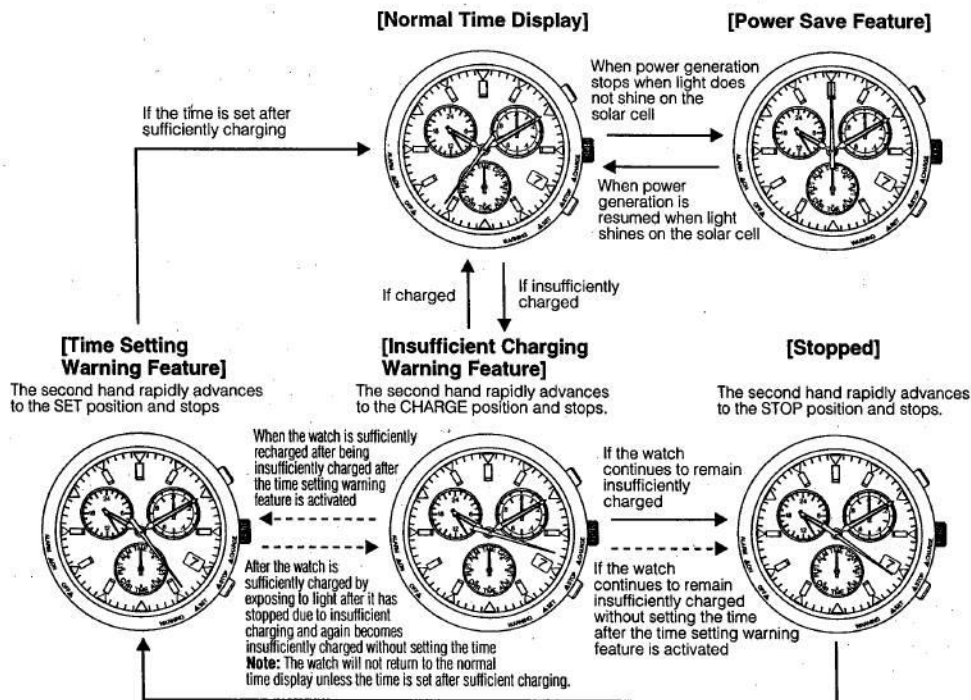

The watch hands begin to move when exposed to light

**Note:** A minimum of 30 minutes are required for the watch to switch to the time setting warning feature display even after the watch is sufficiently exposed to light once the watch has stopped due to insufficient charging.

### <Insufficient Charging Warning Feature>

Regardless of the display of the watch at the time, when the watch becomes insufficiently charged, the watch changes to the time display and the second hand moves to the CHARGE position to inform the wearer that it is insufficiently charged. After the second hand moves to the CHARGE position, the watch changes to the time display in the order of the 24 hour hand, hour hand, minute hand and date wheel (function hand). Although the watch continues to keep time accurately at this time, the watch stops after about 5 days have elapsed (roughly 2 days in the case the hands have been moved to switch the time when the insufficient charging warning feature is activated).

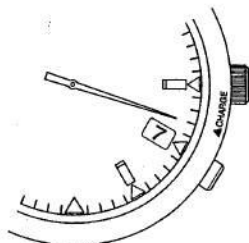

When this happens, charge the watch by exposing to light so that it returns to one-second interval movement. However, since the time is incorrect when the watch is exposed to light and changes to the insufficient charging warning display after it has stopped due to insufficient charging, set the time after sufficiently charging the watch.

### Notes:

- Chronograph measurement stops and the chronograph is reset even when measurement is in progress.
- The set time (time difference) is retained for the local time.
- The alarm will not sound even if it is set.
- Crown (mode switching) and button operations will not function.

### <Time Setting Warning Feature>

When the watch is recharged by exposing to light after it has stopped, the second hand moves to the SET position to inform the wearer that the time is incorrect. Although the 24 hour hand, hour hand and minute hand will begin to move after the second hand moves to the SET position, since the time is incorrect, reset the time and date after sufficiently charging the watch.

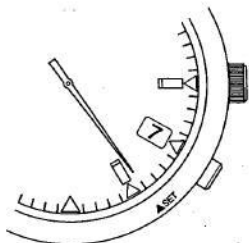

### Notes:

- Crown and button operations will not function except for time and calendar setting operations.
- When the crown is pulled out to position 2 (time correction position) in the time or date setting mode, the time setting warning feature is canceled. The second hand will remain stopped at the SET position unless the crown is pulled out to position 2 and the time is set.
- In the case the watch has stopped due to insufficient charging, a minimum of 30 minutes are required until the watch changes to the time setting warning display even if sufficiently exposed to light.

### <Overcharging Prevention Feature>

The overcharging prevention feature is activated when the secondary battery is full charged so that it is not charged further.

### <Power Save Feature>

When power is no longer generated as a result of light not shining on the solar cell when the watch is in the time/calendar mode or local time mode, the second hand moves to the 0 seconds position and stops to save power by reducing current consumption.

The 24 hour hand, hour hand and minute hand continue to keep the correct time even though the second hand is stopped. Furthermore, the calendar is corrected in coordination with the 24 hour hand, hour hand and minute hand.

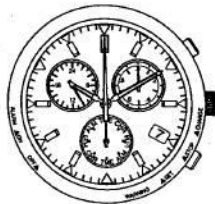

- During normal hand movement, when power generation is resumed after the second hand stops at the 0 seconds position, the second hand is rapidly advanced to the correct seconds and begins one-second interval movement. However, when the insufficient charging warning feature has been activated, the second hand moves to the CHARGE position and stops, and when the time setting warning feature has been activated, it moves to the SET position and stops. When the watch has stopped, the second hand moves to the STOP position and remains stopped.

### Note:

- During the time the secondary battery is full charged and the overcharging prevention feature is operating, the power save feature does not operate even when power generation is interrupted as a result of not exposing the solar cell to light. Similarly, the power save feature will also not operate when the secondary battery has temporarily become fully charged as a result of exposure to intense light.

## §6. GENERAL REFERENCE FOR CHARGING TIMES

The time required for recharging varies according to the model of the watch (color of the dial, etc.). The following times are shown below to serve only as a reference.

\* Recharging time refers to the amount of time the watch is continuously exposed to light.

Illuminance (lx)	Environment	Charging Time		
		Charging time for 1 day of operation	Charging time from the stopped state to 1-second interval movement	Full recharging time
500	Inside an ordinary office	2.5 hours	48 hours	337.5 hours
1,000	60-70cm (24-28 in.) under fluorescent light (30W)	40 minutes	20 hours	134.5 hours
3,000	20cm (8 in.) under fluorescent light (30W)	10.5 minutes	7 hours	42.5 hours
10,000	Outdoors, cloudy weather	5 minutes	2.5 hours	12 hours
100,000	Outdoors, summer, under direct sunlight	1.5 minutes	1 hour	4 hours

**Full recharging time:** Time required for recharging the watch from the stopped state to full charged.

**Charging time for 1 day of operation:** Time required for recharging the watch to run for 1 day at 1-second interval movement.

## §7. NOTES REGARDING HANDLING OF THIS WATCH

### <Try to keep the watch charged at all times.>

Please note that if you wear long sleeves, the watch can easily become insufficiently charged as a result of it being concealed and unable to be exposed to light.

- When you take the watch off, try to place it in as bright a location as possible to ensure that it always keeps the correct time.

### **CAUTION Charging Precautions**

- Avoid recharging at high temperatures (over about 60°C/140°F) since this may result in damage to the watch during recharging.  
**Examples:** Charging the watch in close proximity to an incandescent lamp, halogen lamp or other light source that can easily reach high temperatures, charging the watch in a location that reaches high temperatures such as on a car dashboard.
- When charging the watch with an incandescent lamp, always make sure the watch is at least 50cm (20in.) away from the lamp so that it does not reach excessively high temperatures during charging.

## §8. REPLACING THE SECONDARY BATTERY

Unlike ordinary batteries, the secondary battery used in this watch does not have to be periodically replaced since it is able to be charged and discharged repeatedly.

## §9. SWITCHING THE MODE (DISPLAY FUNCTION)

This watch is equipped with four modes consisting of time/calendar, chronograph, local time and alarm. Since the mode changes when the crown is turned, the current mode can be confirmed with the mode hand.

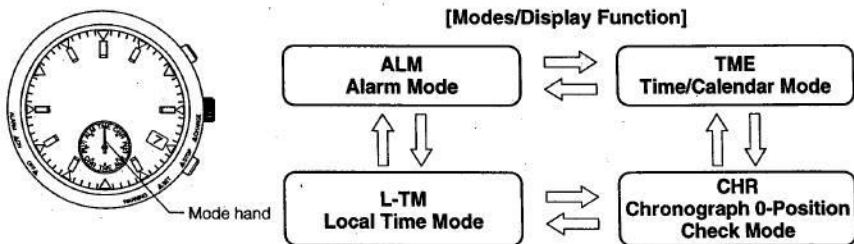

## §10. HAND 0-POSITION CHECK AND CORRECTION

Before using this watch, check that the functions of the watch operate properly by performing the following procedure.

**0-Position:** This refers to the base position of each hand that enables the watch to function properly.

### [0-Position Check]

1. Turn the crown to switch the watch to the chronograph [CHR] mode.
2. Pull the crown out to Position 1 to check the 0-position (function hand and date wheel correction mode.) Confirm that the 24 hour hand, hour hand, minute hand, second hand and function hand rapidly advance to the 0 position, and the date wheel displays "1".

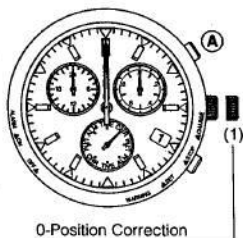

### 0 Positions of each Hand (Base Positions)

24 hour hand: 24:00  
Hour hand, minute hand: 00:00  
Second hand: 00 seconds  
Function hand: 0 position (12:00 position)  
Date wheel: 1st  
Perform the "0-Position Correction" when the hands and date wheel are not at the positions indicated above.

## [0-Position Correction]

### 0-Position Correction of Function Hand and Date Wheel:

1. Pull the crown out to Position 1 in the chronograph [CHR] mode to correct the function hand and date wheel.
2. Click (turn) the crown to the left to align the date wheel.
  - (1) Clicking the crown once causes the function hand to make four revolutions and the date to be corrected by one day.
  - (2) Turning the crown rapidly (clicking continuously two or more times) causes the function hand to advance continuously. When stopping the functions hand, click the crown once to the right or left. When the function hand is not stopped manually, it stops automatically after advancing 31 days.

The 12:00 position immediately after the date changes to the "1st" in the 0 position of the function hand. After correcting the date wheel to the "31st" by turning the crown, press button (A) to finely correct the function hand so that the function hand is aligned at the 0 position after the date wheel changes to the "1st".

### 0-Position Correction of 24 Hour Hand, Hour Hand, Minute Hand and Second Hand:

1. Pull the crown out to Position 2 in the chronograph [CHR] mode to correct each hand.
2. Pressing button (A) causes the second hand to be corrected by one second at a time each time it is pressed. Continuously pressing button (A) causes the second hand to advanced rapidly.
3. Clicking the crown allows correction of the 24 hour hand, hour hand and minute hand.
  - (1) Clicking the crown once to the right causes the hour and minute hands to move clockwise.
  - (2) Clicking the crown once to the left causes the hour and minute hands to move counter-clockwise.
  - Turning the crown rapidly (clocking continuously two or more times) causes the hands to advanced rapidly. When stopping the hands, click the crown once to the right or left. When the hands are not stopped manually, they stop automatically after being corrected by 12 hours.

## §11. SETTING THE TIME AND DATE

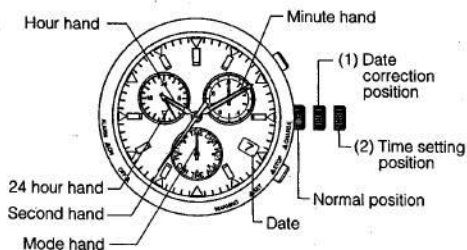

### [Setting the Time]

1. Turn the crown and align the mode hand at the time/calendar [TME] mode.
2. When the crown is pulled out to Position 2 (time setting position), the second hand rapidly advances to the 0 seconds position and stops.

**Note:** When the second hand does not stop at the 0 seconds position, reset the base position in the "0-Position Correction Mode".

**Note:** If the crown is pulled out to Position 2 when the date is changing, the date wheel and function hand stop at the time, and are then advanced by the remaining amount after the second hand is rapidly advanced to the 0 seconds position.

3. Click (turn) the crown to set the time.
  - (1) Clicking the crown once to the right causes the 24 hour hand, hour hand and minute hand to move in the clockwise direction.
  - (2) Clicking the crown once to the left causes the 24 hour hand, hour hand and minute hand to move in the counter-clockwise direction.
  - Turning the crown rapidly (continuously clicking two or more times) causes the hands to advance rapidly. When stopping the hands, click the crown once to the right or left. When the hands are not stopped manually, they stop automatically after being corrected by 12 hours.
4. Return the crown to the normal position in synchronization with a telephone time signal or other time service.

### [Setting the Date]

The calendar function of this watch is a full-auto calendar that changes the year, month and date automatically, including leap years.

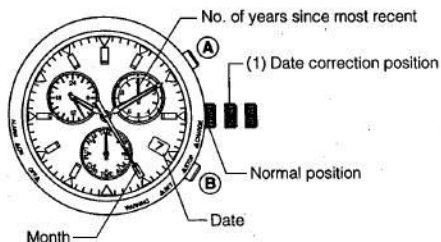

1. Turn the crown to switch the watch to the time/calendar [TME] mode.
2. When the crown is pulled out to Position 1 (date correction position), the second hand rapidly advances to the month display position stored in memory, while the function hand moves to the year display position (number of years elapsed since the most recent leap year), after which both stop.

**Note:** If the crown is pulled out to Position 1 when the date is changing, the second hand advances rapidly after the date changes.

3. Click (turn) the crown to the left to set the date.
  - Clicking the crown once to the left causes the function hand to make four revolution and the date to be corrected by one day.
  - Turning the crown rapidly (continuously clicking two or more times) causes the hand to advance continuously. When stopping the hand, click the crown once to the right or left. When the hand is not stopped manually, it stops automatically after being advanced 31 days.
4. Pressing button (A) allows correction of the year (number of years elapsed since the most recent leap year). Press button (A) and align the function hand at the position corresponding to the year (number of years elapsed since the most recent leap year).

#### \* Interpretation of Year/Position of Function Hand\*

Leap year:	0 minutes position
1 year after most recent leap year:	6 minutes position
2 years after most recent leap year:	12 minutes position
3 years after most recent leap year:	18 minutes position

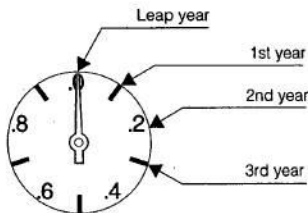

#### Quick Reference Table for No. of Years Since Most Recent Leap Year:

Year	Years elapsed	Year	Elapsed years
2000	Leap year	2004	Leap year
2001	1st year	2005	1st year
2002	2nd year	2006	2nd year
2003	3rd year	2007	3rd year

5. Pressing button **(B)** allows correction of the month. Press **(B)** and align the second hand at the position corresponding to the month.

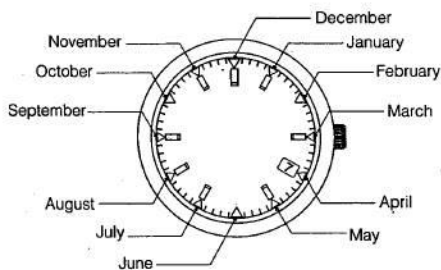

**\*Interpretation of Month/Position of Second Hand\***

- January: 1:00 position  
 February: 2:00 position  
 March: 3:00 position  
 :  
 December: 12:00 position

6. Return the crown to the normal position after setting the date. The watch will resume keeping time once the second hand catches up to the current seconds.

**<When the Calendar has been Set to a Non-existent Date>**

When the crown is returned to the normal position from the date correction mode, the watch switches to the 1st day of the following month.

- Example:** February 29, 30 or 31 in an ordinary year → March 1  
 February 30 or 31 in a leap year → March 1

**§12. USING THE CHRONOGRAPH**

The chronograph is able to measure time up to a maximum of 59 minutes 59.95 seconds in 1/20th second units, after which it resets to 0 seconds.

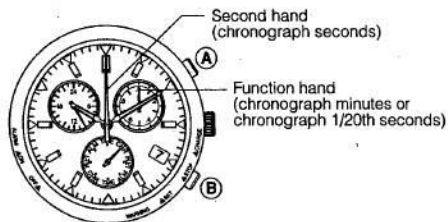

**[Explanation of Hands During Chronograph Measurement]**

When the crown is turned and the mode hand is set to the chronograph [CHR] mode, the second hand and function hand are rapidly advanced to the 0 position and the watch enters the chronograph mode.

- **Second hand:**  
 Switches to the chronograph second hand. The second hand advances rapidly and makes one revolution only when starting at 0 seconds, after which it moves in 1 second increments to measure chronograph seconds.

- **Function hand:**  
 Switches to either chronograph minutes or chronograph 1/20th seconds. The function hand moves in one minute increments to measure chronograph minutes. When button **(B)** is pressed when the chronograph is stopped, the function hand switches to 1/20th seconds display during time button **(B)** is pressed.

**Note:** 24 hour hand, Hour hand, minute hand, date wheel:

- Continue to display the current time when the watch has been switched from the time/calendar mode.
- Continues to display local time when the watch has been switched from the local time mode.
- Continues to display the alarm set time when the watch has been switched from the alarm mode.

### [Chronograph Measurement]

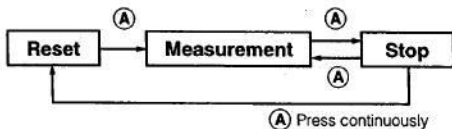

1. Turn the crown to set the mode hand to the chronograph [CHR] mode.
2. Press button (A) to start and stop the chronograph. A confirmation tone is heard whenever button (A) is pressed.
3. Continuously pressing button (A) when the chronograph is stopped causes the chronograph second hand and chronograph minute hand to be reset to the 0 position.

## §13. SETTING LOCAL TIME

The local time function allows the time in a different time zone to be set separately from the current time. Local time is set by performing a time difference correction in 1 hour units based on the current time (time of the time mode/TME). The minute and second hands move in coordination with the current time.

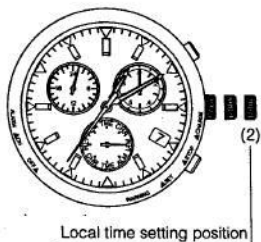

### [Time Difference Correction Procedure]

1. Turn the crown to set the mode hand to the local time [L-TM] mode.
2. Pull out the crown to Position 2 (local time setting position).
3. Click the crown to the right or left to correct the time difference.
  - When the crown is clicked to the right, the hour hand moves by 1 hour in the clockwise direction.
  - When the crown is clicked to the left, the hour hand moves by 1 hour in the counter-clockwise direction.

**Note:** The hour hand is not advanced rapidly even if the crown is continuously clicked two or more times. Perform correction accurately 1 hour at a time. Furthermore, the range of time difference correction is  $\pm 23$  hours based on the current time.

4. Always make sure to return the crown to the normal position after correcting the time difference.

**Note:** If the hour hand passes 12:00 AM (midnight) during correction, the date is advanced by 1 day following completion of hand movement. If the time difference is corrected in the counter-clockwise direction and the hour hand passes back over 12:00 AM, although the date is corrected following completion of hand movement, since the date is corrected by 30 days in the clockwise direction, it takes about 2-3 minutes for the date to be corrected. Pay attention to AM and PM when correcting time difference.

**Note:** When returning the time difference to original setting, return the hour hand in the direction opposite that when the time difference was corrected.

## §14. USING THE ALARM

The alarm function uses a 24-hour clock. Once the alarm has been set, the alarm sounds for 15 seconds when the set time is reached once a day. The time at which the alarm sounds applies to the time (TME) mode, and cannot be set based on the local time (L-TM).

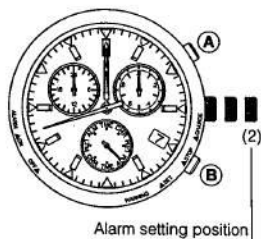

### [Setting the Alarm Time]

1. Turn the crown and set the mode hand to the alarm [ALM] mode.
  - Second hand: Moves rapidly to the ON or OFF position.
  - 24 hour hand, hour hand, minute hand: Move the previously set alarm time.
  - Function hand: Stops at the 0 position.
2. Pull out the crown to Position 2 (alarm setting position).
  - The alarm setting is turned ON automatically.
3. Click (turn) the crown to set the alarm time.
  - (1) Clicking once to the right causes the hour and minute hands to move clockwise.
  - (2) Clicking once to the left causes the hour and minute hands to move counter-clockwise.
  - Turning the crown rapidly (continuously clicking two or more times) causes the hands to advance rapidly. When stopping the hands click the crown once to the right or left. When the hands are not stopped manually, they stop automatically after being corrected by 12 hours.
  - Set the alarm while making sure not to mistake AM and PM by referring to the 24 hour hand.
4. Return the crown to the normal position after setting the alarm time.

### [Switching alarm ON and OFF]

The alarm is switched ON and OFF each time button **A** is pressed when the crown is pulled out to Position 1 or Position 2 in the alarm mode.

### [Alarm Tone Monitor]

When button **A** is pressed with the crown in the normal position in the alarm mode, the alarm tone sounds for as long as button **A** is pressed.

### [Stopping the Alarm Tone]

Press either button **A** or **B** to stop the alarm tone while it is sounding.

## §15. ALL RESET

This watch may not function properly as a result of being subjected to the effects of static electricity or strong impact and so forth. When this happens, set the hands of the watch to their respective base positions according to the following procedure after performing the all-reset procedure.

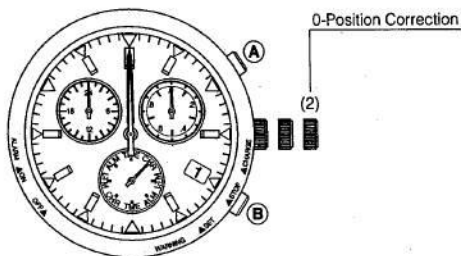

When performing the all-reset procedure, first make sure that the watch is fully charged and the second hand is moving in one second increments. If the all-reset procedure is performed when the watch is insufficiently charged, it may not function properly or remain stopped following the all-reset procedure.

1. Turn the crown to set the mode hand to the chronograph [CHR] mode.
2. Pull out the crown to Position 2 (0-position correction mode).
  - Each of the hands and date wheel move to their respective 0 position stored in memory and then stop.
3. Press buttons **A** and **B** simultaneously and then release.
  - Following a confirmation tone, each of the hands perform a demonstration movement in the order of the function hand, 24 hour hand, hour hand, minute hand and second hand to indicate that the all-reset procedure is finished.

**Note:** Following the all-reset procedure, make sure to properly reset each mode after performing 0-position correction for each hand before using the watch. The watch will remain stopped and not run unless 0-position correction is performed.

## §16. PRECAUTIONS FOR DISASSEMBLY AND ASSEMBLY

### [How to Pull Out Setting Stem from One-piece Case]

#### 1. When removing the setting stem from the case

- Pressing down the end of the unlocking lever for setting stem from above, pull out the setting stem.

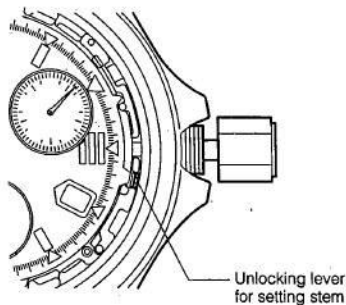

#### <Procedure>

- (1) Set the crown at the normal position (Push it in).
- (2) Lightly press the end of the unlocking lever for setting stem with a screwdriver, etc. from above.
- (3) With the lever pressed, pull out the setting stem.

#### 2. When removing the setting stem from the movement

- Pressing the base of the unlocking lever for setting stem ("PUSH →" position), pull out the setting stem.

#### <Note>

When the movement has been removed from the case, do not press the end of the unlocking lever for setting stem. If it is pressed in this case, it may be pressed too much to deform itself, circuit unit supporter, etc. since there is not a stopper.

If the movement is installed to the case with any part deformed, the setting stem may not be pulled out even if the unlocking lever for setting stem is pressed.

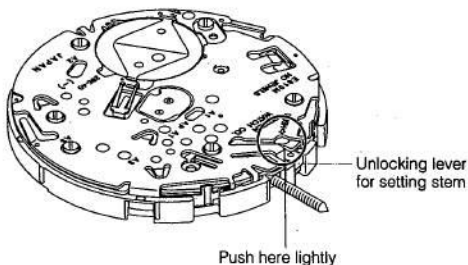

#### <Procedure>

- (1) Set the crown at the normal position (Push it in).
- (2) Lightly press the base of the unlocking lever for setting stem ("PUSH →" position) with a screwdriver, etc. from above.
- (3) With the lever pressed, pull out the setting stem.

## [Precautions for Removal and Setting of Solar Cell]

### 1. Precautions for handling of solar cell

- If the top of the solar cell is damaged, its charging capacity and other functions are lowered. Accordingly, sufficiently take care not to damage the top of the solar cell when removing and setting it.
- If the electrodes are stained or flaked off, a continuity trouble occurs. Since it is difficult to clean the top of solar cell, do not touch them with a finger, etc.

### 2. Removing and setting methods of solar cell

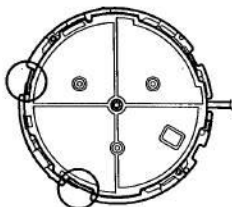
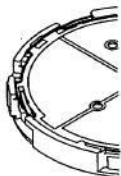
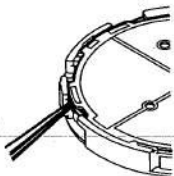
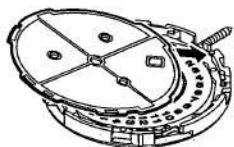
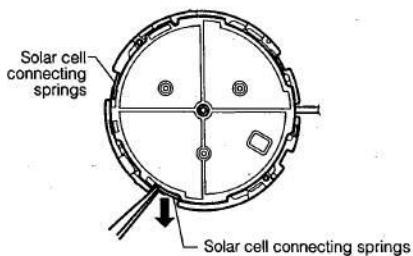

#### <Removing method of solar cell>

- (1) Slide off the contact of each of the two solar cell connecting springs on the top of the solar cell outward.
- (2) Pull and lift up the solar cell in the 9-o'clock direction to remove it.

#### <Setting method of solar cell>

- (1) Slide the solar cell into under the overhanging sheet at the 4-o'clock position of the plate complete.
  - (2) Press down the solar cell lightly.
  - (3) Holding, opening, and lifting up each solar cell connecting spring with tweezers, move its contact onto the solar cell.
- Take care not to deform the spring with a too large force. Deformation of the spring can cause a bad contact, etc.
  - Check that the solar cell connecting spring is securely in contact with the conductor of the solar cell.

## [Assembly of Parts Around Calendar]

### 1. Installing position of intermediate date wheel (2)

Position and install intermediate date wheel (2) through the oval zone of the date dial guard, taking care that its finger tip will not be removed. If this wheel is deviated from the correct position, the changing timing of the date dial changes.

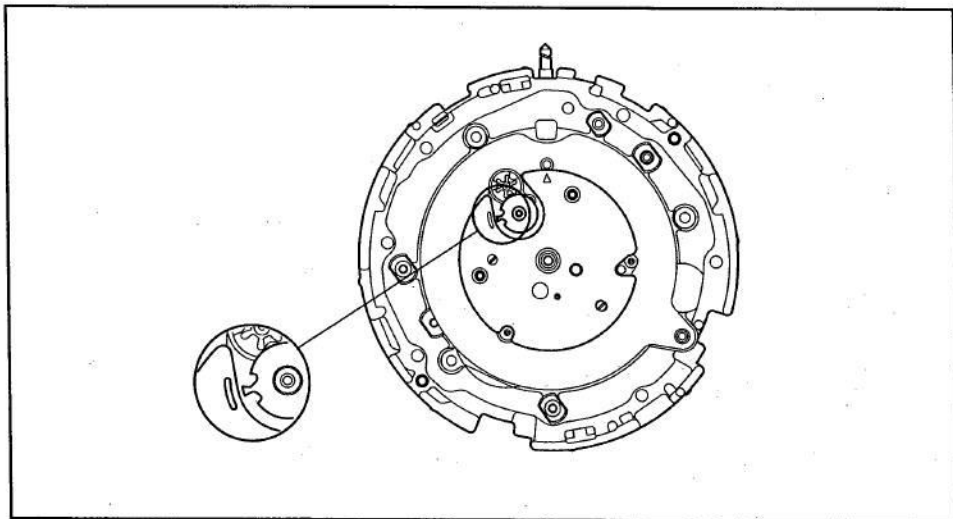

### 2. Installing position of date dial

Position and install the date dial so that the mark "▼" between 22 and 23 on itself will be at the "▲" on the date dial guard. If it is installed correctly, "25" will be indicated in the window at the 4-o'clock position of the solar cell.

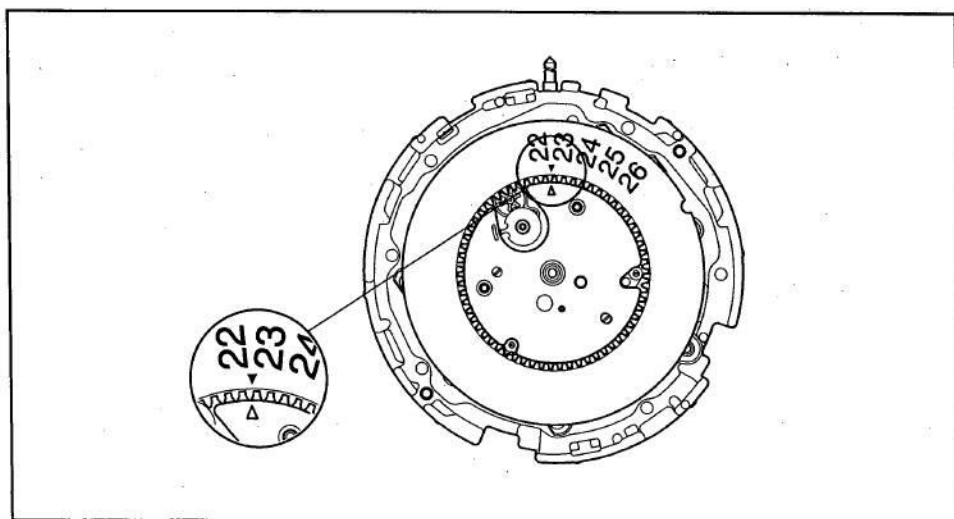

## [How to fit hands]

1. Find the "TME" mode.
  - ① Pull the crown to the second click and fit the second hand temporarily.
  - ② Return the crown to the normal position.
  - ③ Turn the crown to find the 1-second interval movement.
  - ④ Pull the crown to the second click.
    - If the second hand stops, the watch is in the "TME" mode.
    - If the second hand does not stop, the watch is in the "L-TM" mode.
  - ⑤ After finding the "TME" mode, remove the second hand.
2. Perform the all-reset operation in the "TME" Mode.

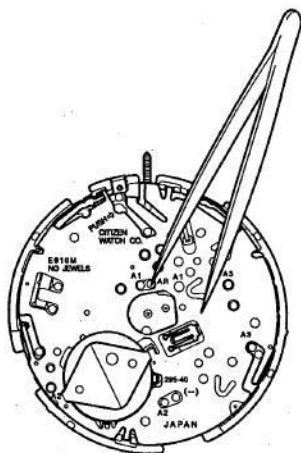

- ① Turn over the movement.
- ② Short the "AR" terminal" to the "circuit unit supporter" with tweezers to perform the all-reset operation.

3. Fit each hand to the correct position.
  - ① Mode hand: Position and fit to the division of the "TME" mode.
  - ② Function hand: Position and fit to the division of "0".
  - ③ 24-hour hand: Position and fit to the division of "24".
  - ④ Hour, minute, and second hands: Position and fit to the division of "12".
4. Perform the "0-adjustment" operation for each hand in the "CHR" mode.
  - For the "0-adjustment" operation, see "10. Check and correction of 0-position of each hand". If the 0-adjustment operation is not performed, the watch does not start.
5. Set the movement in the case and set each mode correctly.

# §17. DISASSEMBLY AND ASSEMBLY OF MOVEMENT

Disassembly procedure: ① → ⑥①

Assembly procedure: ⑥① → ①

● Lubrication mark

⊖ : A-Lube oil

∇ : V-Lube oil

⊙ : F-Lube oil

○ : CH-1 oil

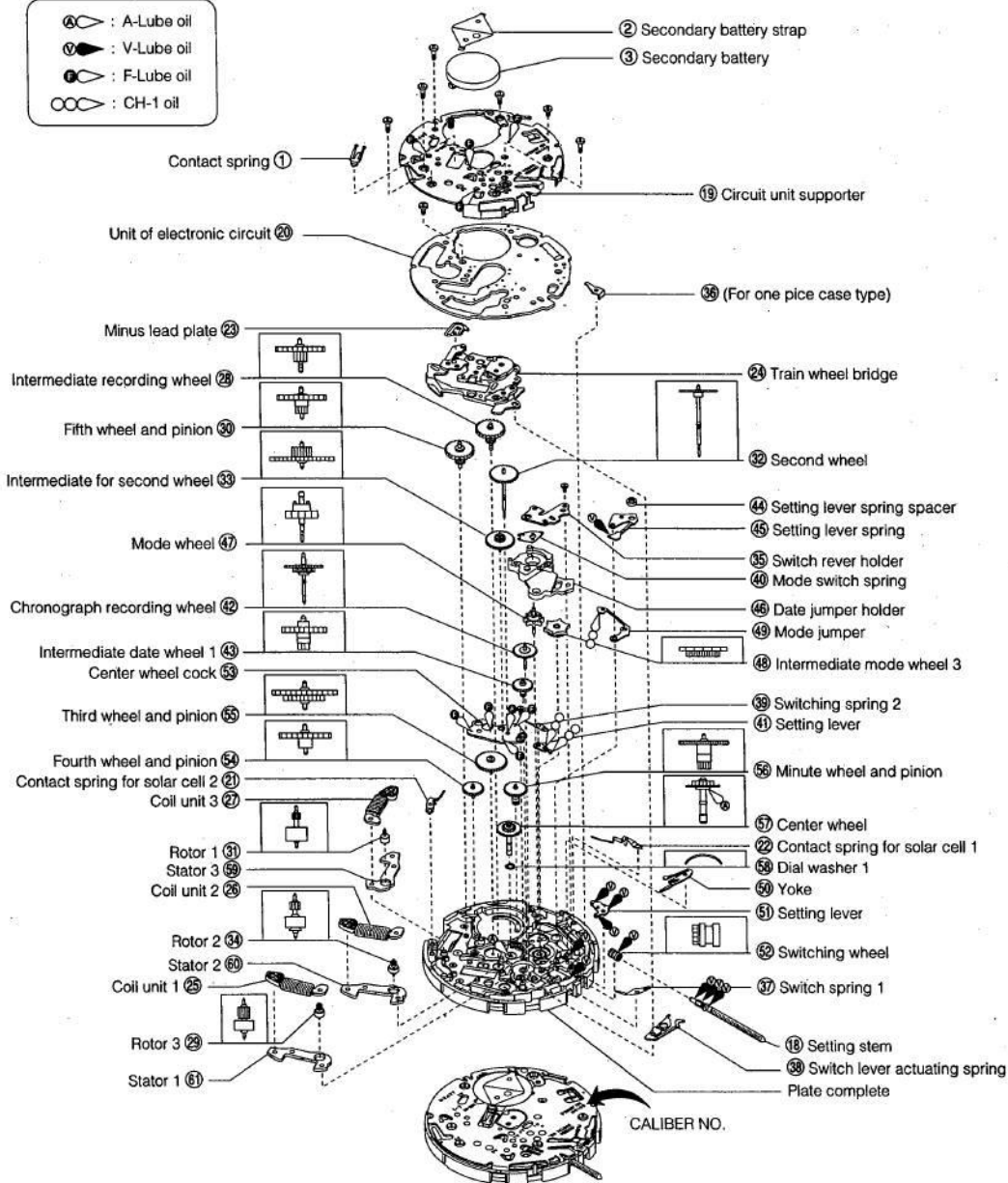

## [Arrangement of wheels]

### <From center wheel to mode wheel>

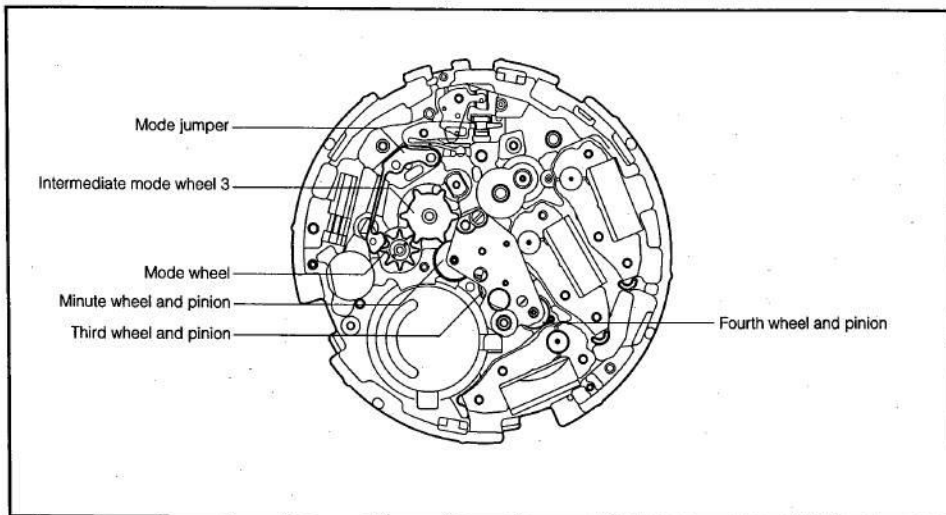

### <From intermediate date wheel to intermediate recording wheel>

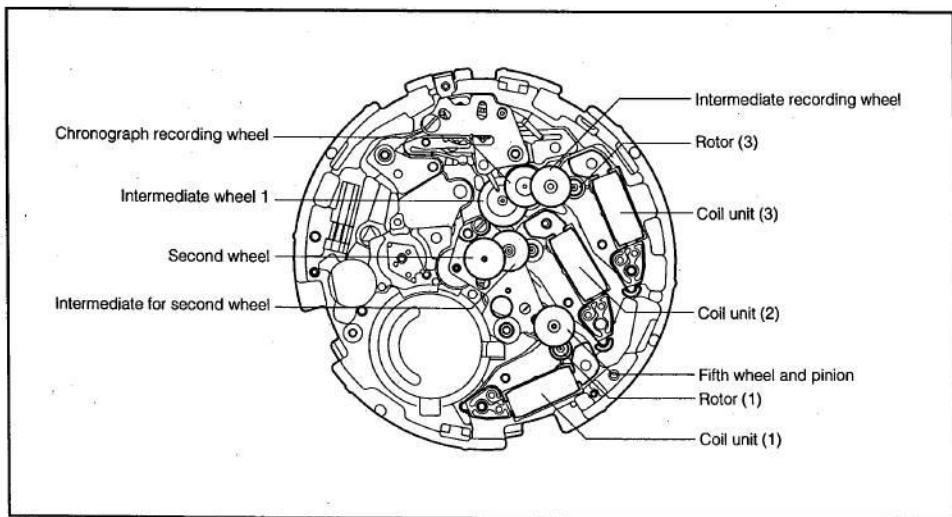

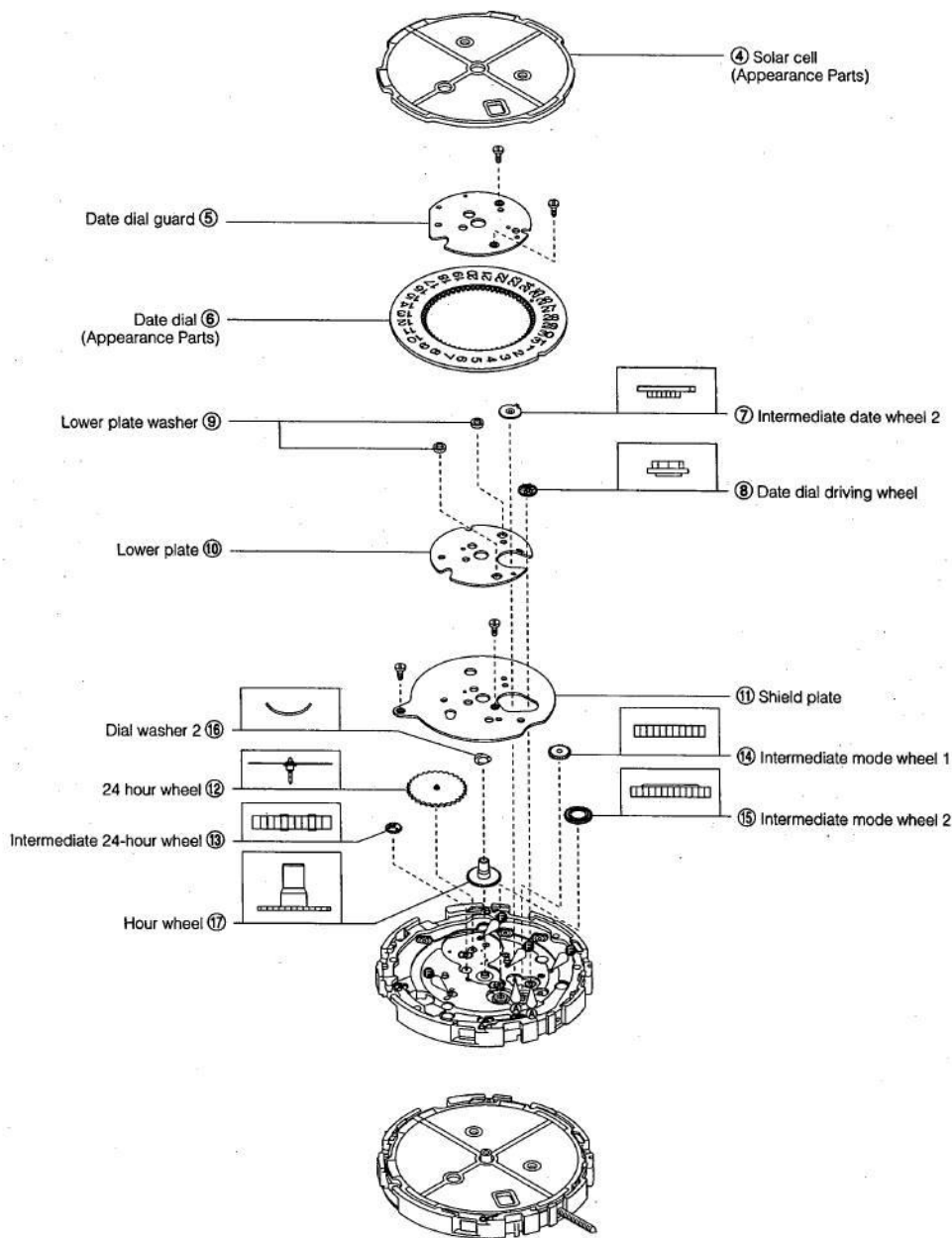

# §18. TROUBLESHOOTING AND ADJUSTMENT METHOD

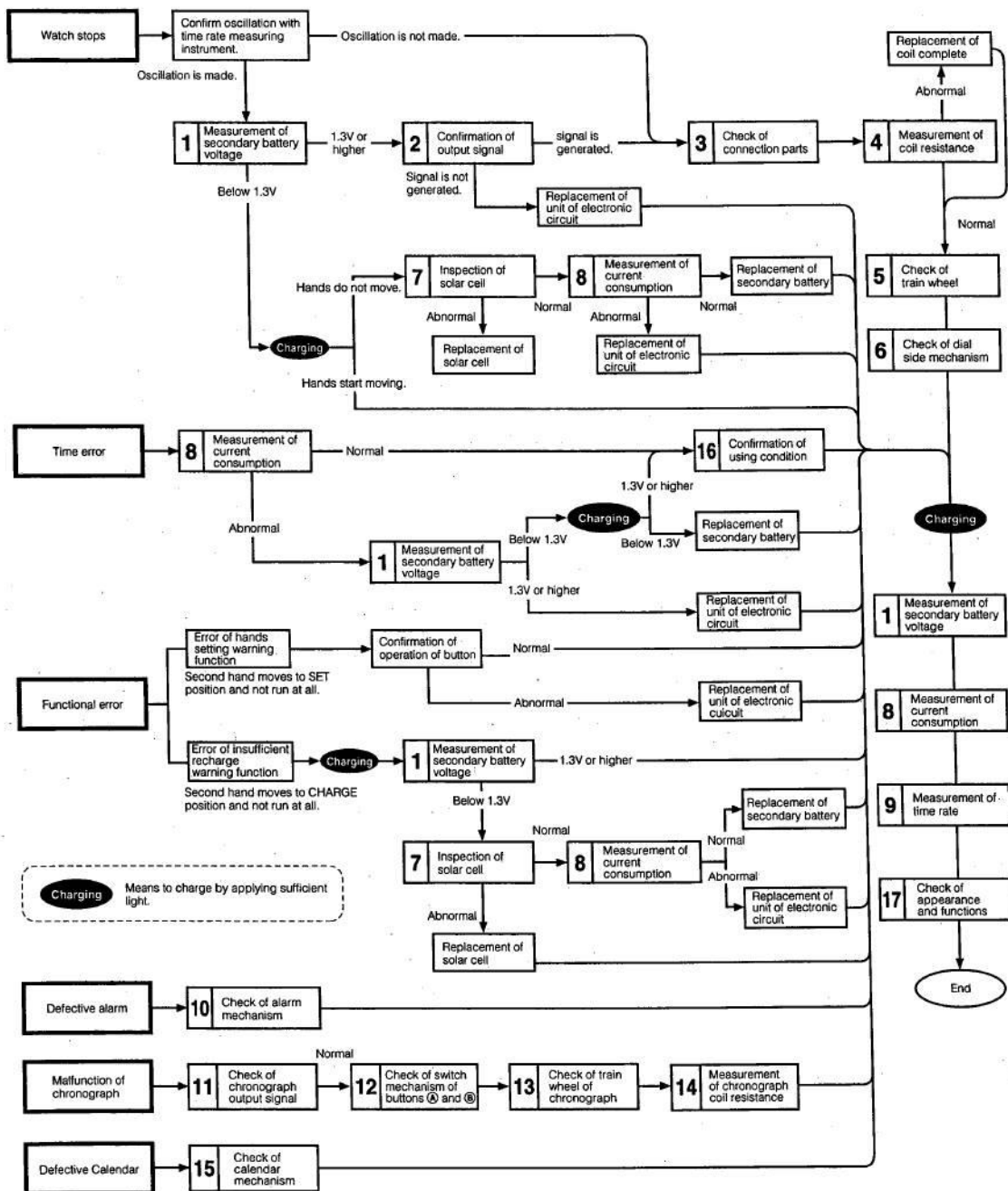

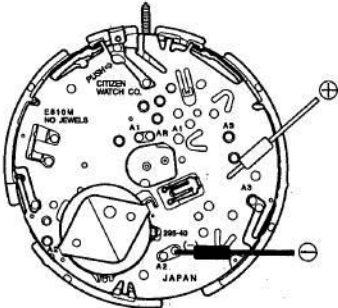
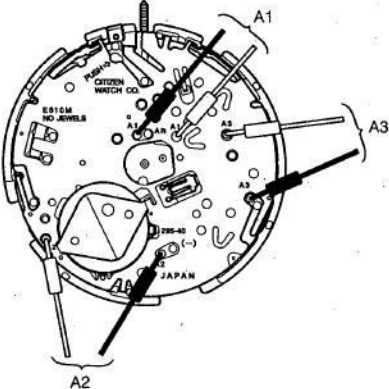
Check Items	How to Check	Results and Treatment
<p>① Measurement of secondary battery voltage</p>	<p>* Refer to Technical Manual Basic Course II-1-a.</p> <p>&lt;Tester range: 3V&gt;</p> 	<p><b>Over 1.3 V</b> → Non defective</p> <p><b>Under 1.3 V</b> → Recharging.</p>
<p>② Confirmation of output signal</p>	<p>* Refer to Technical Manual Basic Course II-1-b.</p> <p>&lt;Tester range: D.C. 0.3V&gt;</p>  <p>This watch output the signals as following.</p> <ul style="list-style-type: none"> <li>• Output signals (A1) of the time system (Second).</li> <li>• Output signals (A2) of the time system (Minute, hour, 24 hour).</li> <li>• Output signals (A3) of the chronograph system.</li> </ul>	<p>Check the output signal A1. The tester pointer swings every second in the TME mode → Non defective</p> <p>The tester pointer does not swings → Check the connection parts</p> <p>Check the output signal A2. The tester pointer swings every 15 seconds in the TME mode → Non defective</p> <p>The tester pointer does not swings → Check the connection parts.</p> <p>Check the output signal A3.</p> <ol style="list-style-type: none"> <li>1. Press the (A) button in the CHR mode to start the chronograph. The tester pointer swings every minute → Non defective</li> </ol> <p>The tester pointer does not swings → Check the connection parts</p> <ol style="list-style-type: none"> <li>2. Pull the crown to the first click in the TME mode and turn it to the left continuously to turn the date dial forward continuously.</li> </ol> <p>The tester pointer swings continuously → Non defective</p> <p>The tester pointer does not swing → Replace the circuit</p>

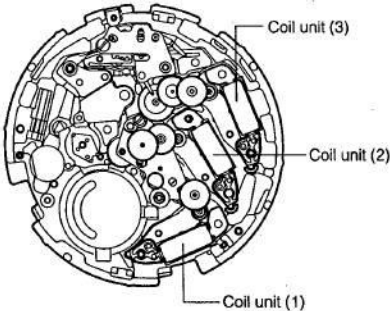
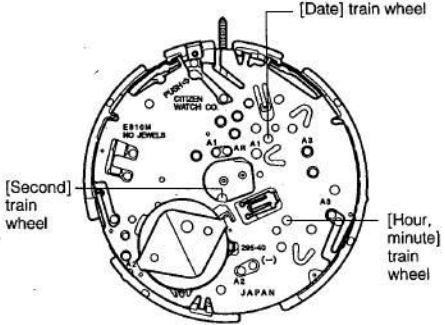
Check Points	How to Check	Results and Treatments																		
<p>③ Check of connection part</p>	<p>* Refer to Technical Manual Basic Course II-2-a.</p>																			
<p>④ Measurement of coil resistance</p>	<p>* Refer to Technical Manual Basic Course II-1-c.</p> <p style="text-align: center;">&lt;Tester range: R x 10Ω&gt;</p>  <p style="text-align: right;">Coil unit (3)</p> <p style="text-align: right;">Coil unit (2)</p> <p style="text-align: right;">Coil unit (1)</p>	<ul style="list-style-type: none"> <li>• Coil unit [1], [3] <b>1.0 kΩ ~ 1.4 kΩ</b> → Non defective</li> <li>• Coil unit [2] <b>1.8 kΩ ~ 2.4 kΩ</b> → Non defective</li> <li>• Outside range of above value. → Replace the coil unit</li> </ul>																		
<p>⑤ Check of train wheels</p>	<p>* Refer to Technical Manual Basic Course II-2-b.</p> <ul style="list-style-type: none"> <li>• Check that the all wheels are meshed smoothly.</li> <li>• Check the lubricating condition, etc.</li> <li>• Check that each train wheel works normally.</li> </ul> <p><b>Check of train wheel</b></p> <table border="1" style="width: 100%; border-collapse: collapse;"> <thead> <tr> <th style="text-align: left;">Mode</th> <th style="text-align: left;">Position of crown</th> <th style="text-align: left;">Working condition</th> </tr> </thead> <tbody> <tr> <td>TME mode</td> <td>Normal position</td> <td>"Second" train wheel: Revolves every second. "Hour, minute" train wheels: Revolve every 15 seconds.</td> </tr> <tr> <td>Calendar setting</td> <td>First click position</td> <td>"Second" train wheel: Revolves continuously after the crown is pulled to the first click position, then stops. If the <b>(B)</b> button is pressed, this wheel revolves by an angle for 5 seconds. "Date" train wheel: Revolves continuously if the <b>(A)</b> button is pressed or the crown is turned to the left.</td> </tr> <tr> <td>Time setting</td> <td>Second click position</td> <td>"Second" train wheel: Revolves continuously after the crown is pulled to the second click position, then stops.</td> </tr> <tr> <td>CHR mode</td> <td>Normal position</td> <td>"Hour, minute" train wheels: Revolve continuously if the crown is turned continuously. "Second" train wheel: Revolves continuously and then revolves every second if the <b>(A)</b> button is pressed.</td> </tr> <tr> <td>ALM mode</td> <td>First click position Second click position</td> <td>"Hour, minute" train wheels: Revolve every 15 seconds if the <b>(A)</b> button is pressed. "Date" train wheel: Revolves every minute if the <b>(A)</b> button is pressed. "Second" train wheel: Revolves continuously if the <b>(A)</b> button is pressed. "Second" train wheel: Revolves continuously if the <b>(A)</b> button is pressed. "Hour, minute" train wheel: Revolve continuously if the crown is turned.</td> </tr> </tbody> </table>  <p style="text-align: right;">[Date] train wheel</p> <p>[Second] train wheel</p> <p style="text-align: right;">[Hour, minute] train wheel</p>	Mode	Position of crown	Working condition	TME mode	Normal position	"Second" train wheel: Revolves every second. "Hour, minute" train wheels: Revolve every 15 seconds.	Calendar setting	First click position	"Second" train wheel: Revolves continuously after the crown is pulled to the first click position, then stops. If the <b>(B)</b> button is pressed, this wheel revolves by an angle for 5 seconds. "Date" train wheel: Revolves continuously if the <b>(A)</b> button is pressed or the crown is turned to the left.	Time setting	Second click position	"Second" train wheel: Revolves continuously after the crown is pulled to the second click position, then stops.	CHR mode	Normal position	"Hour, minute" train wheels: Revolve continuously if the crown is turned continuously. "Second" train wheel: Revolves continuously and then revolves every second if the <b>(A)</b> button is pressed.	ALM mode	First click position Second click position	"Hour, minute" train wheels: Revolve every 15 seconds if the <b>(A)</b> button is pressed. "Date" train wheel: Revolves every minute if the <b>(A)</b> button is pressed. "Second" train wheel: Revolves continuously if the <b>(A)</b> button is pressed. "Second" train wheel: Revolves continuously if the <b>(A)</b> button is pressed. "Hour, minute" train wheel: Revolve continuously if the crown is turned.	
Mode	Position of crown	Working condition																		
TME mode	Normal position	"Second" train wheel: Revolves every second. "Hour, minute" train wheels: Revolve every 15 seconds.																		
Calendar setting	First click position	"Second" train wheel: Revolves continuously after the crown is pulled to the first click position, then stops. If the <b>(B)</b> button is pressed, this wheel revolves by an angle for 5 seconds. "Date" train wheel: Revolves continuously if the <b>(A)</b> button is pressed or the crown is turned to the left.																		
Time setting	Second click position	"Second" train wheel: Revolves continuously after the crown is pulled to the second click position, then stops.																		
CHR mode	Normal position	"Hour, minute" train wheels: Revolve continuously if the crown is turned continuously. "Second" train wheel: Revolves continuously and then revolves every second if the <b>(A)</b> button is pressed.																		
ALM mode	First click position Second click position	"Hour, minute" train wheels: Revolve every 15 seconds if the <b>(A)</b> button is pressed. "Date" train wheel: Revolves every minute if the <b>(A)</b> button is pressed. "Second" train wheel: Revolves continuously if the <b>(A)</b> button is pressed. "Second" train wheel: Revolves continuously if the <b>(A)</b> button is pressed. "Hour, minute" train wheel: Revolve continuously if the crown is turned.																		

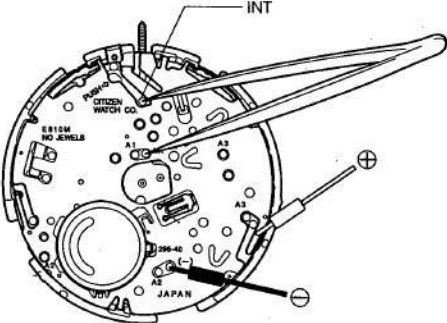
Check Items	How to Check	Results and Treatment
<p>⑥ Check of dial side mechanism</p>	<p>* Refer to Technical Manual Basic Course II-2-c.</p> <ol style="list-style-type: none"> <li>1. Pull the crown to the second click in the TME mode and turn it to check that the hands are moved normally.</li> <li>2. Pull the crown to the first click in the TME mode and turn it to check that the date dial is moved normally.</li> </ol>	
<p>⑦ Check of solar cell</p>	<p>• Check the solar cell for breakage and stain, and check its electrode for stain and flaking.</p>	<p>Breakage of solar cell → Replace solar cell.</p> <p>Stain → Remove stain.</p> <p>Flaking of electrode → Replace solar cell.</p>
<p>⑧ Measurement of current consumption</p>	<p>* Refer to Technical Manual Basic Course II-1-f. &lt;Tester range: DC 10<math>\mu</math>A&gt;</p> <p><b>Measurement of current consumption</b></p> <ol style="list-style-type: none"> <li>1. Turn the crown to set the watch in the "TME" mode.</li> <li>2. Take the "secondary battery strap" and "secondary battery" out of the movement.</li> <li>3. Referring to Technical Manual Basic Course, set the silver battery (1.55V) to the adapter of the tester correctly.</li> <li>4. Set the tester <ul style="list-style-type: none"> <li>• Replace the positive <math>\oplus</math> tester lead pin with an alligator clip and install it to the ground spring of the circuit unit supporter.</li> <li>• Apply the negative <math>\ominus</math> tester lead pin to the negative <math>\ominus</math> pattern of the unit of electronic circuit.</li> </ul> </li> <li>5. Apply either leg of tweezers to the "AR" pattern" and the other leg to the "INT pattern" and circuit unit supporter simultaneously to short them.</li> <li>6. After shorting, release the "AR pattern" first.</li> <li>7. Check that the "second" train wheel is revolving and then release the "INT pattern". <ul style="list-style-type: none"> <li>• If the "second" train wheel does not revolve, repeat the above work from 5 to 7.</li> </ul> </li> <li>8. Measure the current consumption. <ul style="list-style-type: none"> <li>• The tester pointer indicates a high value at first. Wait until the tester pointer is stabilized and then measure the current consumption.</li> </ul> </li> </ol> <div style="text-align: center;">  </div> <p><b>Precaution</b> When measuring the current consumption, take care not to apply light to the solar cell. If the solar cell is exposed to light, the voltage changes and the current consumption cannot be measured accurately.</p>	<p>• Current consumption of the movement</p> <p><b>Under 1.0 <math>\mu</math>A</b> → Non defective</p> <p><b>Over 1.0 <math>\mu</math>A</b> → Check train wheel → Remove dirt.</p> <p>Module is non defective, but current consumption is over 1.0 <math>\mu</math>A.</p> <p style="text-align: center;">↓</p> <p>Replace of unit of electronic circuit</p>

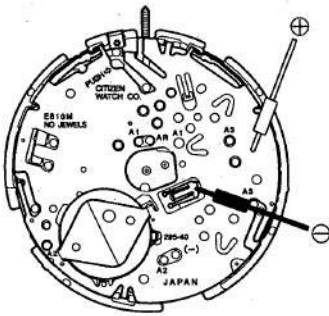
Check Points	How to Check	Results and Treatments
<p>⑨ Measurement of time rate</p>	<p>* Refer to Basic Course II-2-d.            &lt;Measurement gate: Analog 10 sec&gt;</p> <ul style="list-style-type: none"> <li>• The time rate cannot be adjusted.</li> <li>• The time rate may not be measured accurately while the insufficient charge warning display or time setting warning display is turned on. In this case, apply light to the watch until the hand moves normally, then measure the time rate.</li> </ul>	<ul style="list-style-type: none"> <li>• The watch loses or gains substantial time            → Replace the unit of electronic circuit.</li> </ul>
<p>⑩ Check of alarm mechanism</p>	<p>* Refer to Technical Manual, Basic Course: II-1-d.</p> <ol style="list-style-type: none"> <li>1. Set the movement in the case, and check output of alarm with the case back removed.</li> <li>2. Turn the crown to switch to the alarm mode.</li> <li>3. Apply ⊕ lead pin to circuit unit supporter surface and ⊖ lead pin to buzzer contact spring (flat part), then press <b>A</b> button.            At this time, check the alarm output signal by the swing of the tester pointer.</li> </ol> <p style="text-align: right;">&lt;Tester range: D.C. 0.3 V&gt;</p> <div style="text-align: center;">  </div> <ol style="list-style-type: none"> <li>4. If the output of alarm is normal, perform the following inspection.           <ul style="list-style-type: none"> <li>• Check the piezo-electric element of vibrating plate for cracks and breakage.</li> <li>• Check the buzzer contact spring for bend and deformation.</li> <li>• Check the pattern of electronic circuit unit for dust and stain.</li> </ul> </li> </ol>	<ul style="list-style-type: none"> <li>• The tester pointer swings            → Non defective.</li> <li>• The tester pointer does not swings            → Replace of unit of electronic circuit</li> </ul>

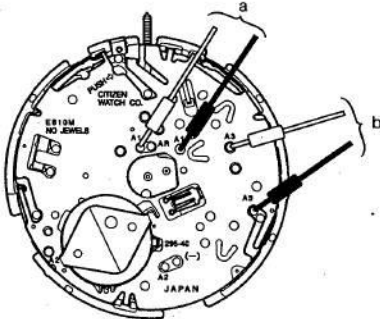
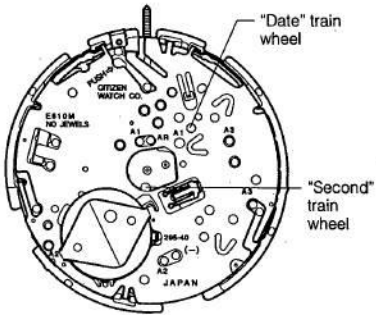
Check Points	How to Check	Results and Treatments
<p>① Check of output signals of chronograph</p>	<p>* Refer to Technical Manual, Basic Course: II-1-b for the setting procedure of the tester.</p> <p>(a) Check the output signal (A1) to drive the step motor for the second hand of the chronograph.</p> <p>(b) Check the output signal (A3) to drive the step motor for the minute hand of the chronograph.</p> <p><b>(Measuring method)</b> Before measuring any of the above signals, start the chronograph.</p> 	<p>a. Output signal of 1-second chronograph</p> <ul style="list-style-type: none"> <li>• Tester pointer moves to right and left from 0V every 1 sec. → Normal</li> <li>• Tester pointer does not move. → Replace electronic circuit unit.</li> </ul> <p>b. Output signal of 1-minute chronograph</p> <ul style="list-style-type: none"> <li>• Tester pointer moves to right and left from 0V every 1 min. → Normal.</li> <li>• Tester pointer does not move. → Replace electronic circuit unit.</li> </ul>
<p>② Check of switch mechanism of button A and B</p>	<ol style="list-style-type: none"> <li>1. Confirm that the buttons A and B operate smoothly and check the switch springs of A and B for deformation.</li> <li>2. Check the part between the switch springs and pattern of the electronic circuit unit of dirt and dust.</li> </ol>	<ol style="list-style-type: none"> <li>1. Buttons do not move smoothly. <ul style="list-style-type: none"> <li>• Dust or dirt → Clean.</li> <li>• Supply oil to push button packings again.</li> <li>• Deformation → Replace parts.</li> </ul> </li> <li>2. Dust or dirt → Clean.</li> </ol>
<p>③ Check of train wheel of chronograph</p>	<p>* Refer to Technical Manual, Basic Course: II-2-b.</p> <ol style="list-style-type: none"> <li>1. Press the A button and check that the "second" train wheel revolves.</li> <li>2. Press the A button to stop the chronograph and press the B button and check that the "date" train wheel revolves.</li> </ol> 	<ol style="list-style-type: none"> <li>1. Train wheel does not revolve. <ul style="list-style-type: none"> <li>• Wheel is deformed or its teeth is broken. → Replace parts.</li> <li>• Lubrication trouble. → Supply lubricant.</li> <li>• Dust or dirt → Clean.</li> </ul> </li> </ol>

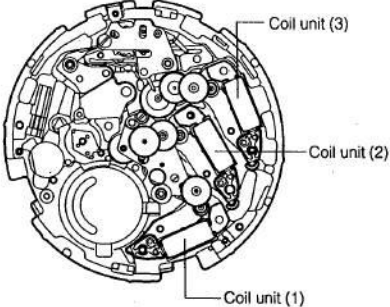
Check Points	How to Check	Results and Treatments
<p>15 Measurement of coil resistance of chronograph</p>	<p>* Refer to Technical Manual, Basic Course: II-1-c for the setting procedure of the tester.</p> <p><b>&lt;Measuring position&gt;</b> Measure the resistance of coil unit (3).</p> 	<p><b>Coil unit (3)</b></p> <ul style="list-style-type: none"> <li>• 1.0 kΩ - 1.4 kΩ → Normal</li> <li>• Out of 1.0 kΩ - 1.4 kΩ → Replace coil unit (3).</li> </ul>
<p>16 Check of calendar mechanism</p>	<p>* Refer to Basic Course: II-2-c.</p> <ol style="list-style-type: none"> <li>1. Check that the intermediate date wheel (2) is installed to the correct position.</li> <li>2. Check that the mark "▼" on the date dial is matched to the mark "▲" on the date dial guard.</li> <li>3. Check that the date changes by one day each time the function hand moves by 4 turns.</li> </ol>	
<p>16 Confirmation of using condition</p>	<p>* Refer to Basic Course: II-2-e.</p> <ul style="list-style-type: none"> <li>• Since this watch is energized by light, it should receive light as much as possible. If the watch is placed near a light source which generates heat (above 60°C) such as an incandescent lamp, a halogen lamp, etc., its functions and parts may be deteriorated or deformed by the heat. Accordingly, take care when applying light to it.</li> </ul> <p>Example: When the watch is hidden under a long sleeve or the customer works in a dark place, it needs to be exposed to light on purpose.</p> <ul style="list-style-type: none"> <li>• It is important to check that the secondary battery is charged normally (the customer knows that this watch is a solar watch) and explain the correct charging method to the customer.</li> </ul>	
<p>17 Check of appearance and function</p>	<p>* Refer to Basic Course: II-2-f.</p> <ul style="list-style-type: none"> <li>• Check that there is not dust or dirt.</li> <li>• Check that each push-button is free from abnormality.</li> <li>• Perform the alarm monitor operation to check that the alarm sounds.</li> </ul>	