

Operation Guide 3148

CASIO®

Getting Acquainted

Congratulations upon your selection of this CASIO watch. To get the most out of your purchase, be sure to read this manual carefully.

Applications

The built-in sensors of this watch measure barometric pressure, temperature and altitude. Measured values are then shown on the display. Such features make this watch useful when hiking, mountain climbing, or when engaging in other such outdoor activities.

Keep the watch exposed to bright light

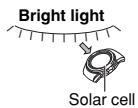

The electricity generated by the solar cell of the watch is stored by a built-in battery. Leaving or using the watch where it is not exposed to light causes the battery to run down. Make sure the watch is exposed to light as much as possible.

- When you are not wearing the watch on your wrist, position the face so it is pointed at a source of bright light.
- You should try to keep the watch outside of your sleeve as much as possible. Charging is reduced significantly if the face is covered only partially.

- The watch continues to operate, even when it is not exposed to light. Leaving the watch in the dark can cause the battery to run down, which will cause some watch functions to be disabled. If the battery goes dead, you will have to re-configure watch settings after recharging. To ensure normal watch operation, be sure to keep it exposed to light as much as possible.

Battery charges in the light.

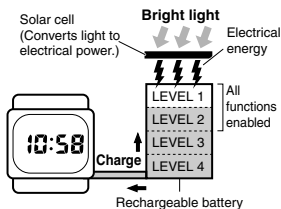

Battery discharges in the dark.

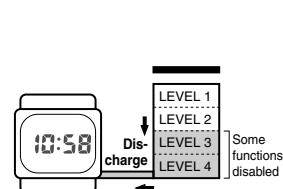

- The actual level at which some functions are disabled depends on the watch model.
- Frequent display illumination can run down the battery quickly and require charging. The following guidelines give an idea of the charging time required to recover from a single illumination operation.
 - Approximately five minutes exposure to bright sunlight coming in through a window
 - Approximately 50 minutes exposure to indoor fluorescent lighting
- Be sure to read "Power Supply" for important information you need to know when exposing the watch to bright light.

If the display of the watch is blank...

If the display of the watch is blank, it means that the watch's Power Saving function has turned off the display to conserve power.

- See "Power Saving" for more information.

Warning!

- The measurement functions built into this watch are not intended for taking measurements that require professional or industrial precision. Values produced by this watch should be considered as reasonable representations only.
- CASIO COMPUTER CO., LTD. assumes no responsibility for any loss, or any claims by third parties that may arise through the use of this watch.

About This Manual

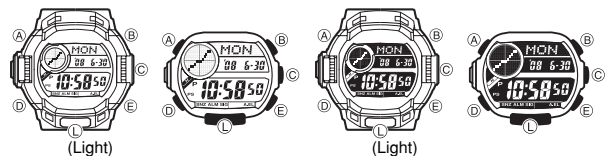

- Button operations are indicated using the letters shown in the illustration.
- Each section of this manual provides you with the information you need to perform operations in each mode. Further details and technical information can be found in the "Reference" section.

General Guide

- The illustration below shows which buttons you need to press to navigate between modes.
- In any mode, press (L) to illuminate the display.

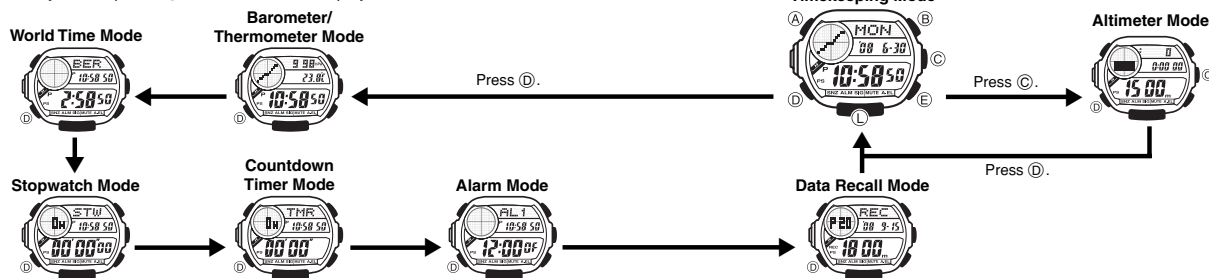

Timekeeping

Use the Timekeeping Mode to set and view the current time and date.

- In the Timekeeping Mode, you can use the buttons shown in the illustration to display the timekeeping display you want.
- Pressing the (B) button once will display the current time in the city you last viewed in the World Time Mode.
- Holding down the (B) button for about five seconds will swap the World Time City and your current Home Time City.
- To swap the cities back again, hold down the (B) button for about five seconds again.

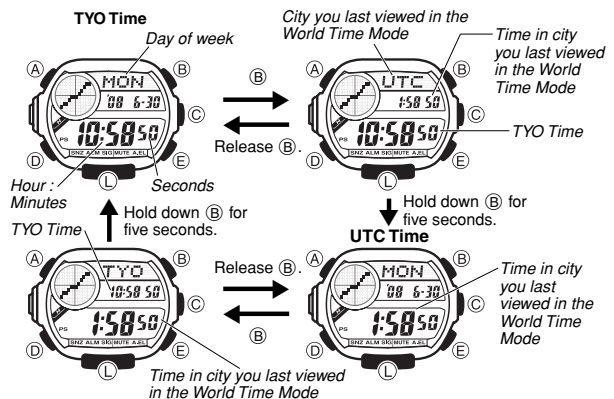

Read This Before You Set the Time and Date!

This watch is preset with a number of city codes, each of which represents the time zone where that city is located. When setting the time, it is important that you first select the correct city code for your Home City (the city where you normally use the watch). If your location is not included in the preset city codes, select the preset city code that is in the same time zone as your location.

- Note that all of the times for the World Time Mode city codes are displayed in accordance with the time and date settings you configure in the Timekeeping Mode.

To set the time and date

- In the Timekeeping Mode, hold down (A) until the city code starts to flash, which indicates the setting screen.
- Use (E) and (B) to select the city code you want.
 - Make sure you select your Home City code before changing any other setting.
 - For full information on city codes, see the "City Code Table".
- Press (D) to move the flashing in the sequence shown below to select the other settings.

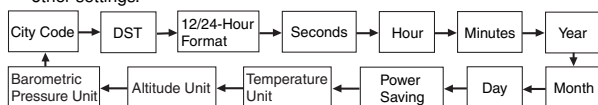

- The following steps explain how to configure timekeeping settings only.
- When the timekeeping setting you want to change is flashing, use (E) and (B) to change it as described below.

Screen	To do this:	Do this:
EEER	Change the city code	Use (E) (east) and (B) (west).
DST ON	Toggle between Daylight Saving Time (DST) and Standard Time (ST).	Press (E).
24H	Toggle between 12-hour (12H) and 24-hour (24H) timekeeping.	Press (E).
50	Reset the seconds to 00	Press (E).
10:58	Change the hour or minutes	Use (E) (+) and (B) (-).
00 6:30	Change the year, month, or day	

- Press (A) to exit the setting screen.

Note

- You also need to enter the Timekeeping Mode in order to configure the following settings.

Power saving on/off ("To turn Power Saving on and off")
 Temperature, barometric pressure, and altitude units ("To select the temperature, barometric pressure, and altitude units")

Daylight Saving Time (DST)

Daylight Saving Time (summer time) advances the time setting by one hour from Standard Time. Remember that not all countries or even local areas use Daylight Saving Time.

To change the Daylight Saving Time (summer time) setting

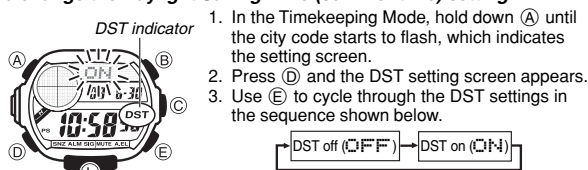

- When the setting you want is selected, press (A) to exit the setting screen.
- The DST indicator appears to indicate that Daylight Saving Time is turned on.

Altimeter

The watch's altimeter uses a pressure sensor to detect current air pressure, which is then used to estimate the current altitude based on ISA (International Standard Atmosphere) preset values. You can specify a reference altitude, which the watch will use to calculate your current altitude based on the value you specify. Altimeter functions also include storage of measurement readings in memory.

Important!

- This watch estimates altitude based on air pressure. This means that altitude readings for the same location may vary if air pressure changes.
- The semiconductor pressure sensor used by the watch for altitude readings is also affected by temperature. When taking altitude readings, make sure the watch is not subjected to temperature changes.

- To avoid the effect of sudden temperature changes during readings, keep the watch on your wrist in direct contact with your skin.
- Do not rely upon this watch for altitude readings or perform button operations while sky diving, hang gliding, or paragliding, while riding a gyrocopter, glider, or any other aircraft, or while engaging in any other activity where there is the chance of sudden altitude changes.
- Do not use this watch for taking altitude readings in applications that demand professional or industrial level precision.
- Remember that the air inside of a commercial aircraft is pressurized. Because of this, the readings produced by this watch will not match the altitude readings announced or indicated the flight crew.

How the Altimeter Measures Altitude

The altimeter can measure altitude based on its own preset values, or a reference altitude specified by you.

When you measure altitude based on preset values

Data produced by the watch's barometric pressure sensor is converted to approximate altitude based on ISA (International Standard Atmosphere) conversion values stored in watch memory.

When you measure altitude using a reference altitude specified by you

After you specify a reference altitude, the watch will use that value to convert the current barometric pressure reading to altitude.

- When mountain climbing, you can specify a reference value in accordance with a marker along the way or altitude information from a map. After that, altitude readings produced by the watch will be more accurate than they would without a reference altitude.



Displaying Your Current Altitude

You can use the procedure described in this section to display your current altitude. If you leave the watch in the Altimeter Mode, it will update the displayed altitude value regularly, and indicate reading-to-reading changes in a window in the upper left of the display.

You can select either of the following two altitude measurement intervals.

0'05": Readings at five-second intervals for one hour

2'00": Readings at five-second intervals for the first three minutes followed by two-minute intervals for 10 hours

- For information about configuring settings for the altitude reading interval and duration, see "To specify the altitude reading interval".

Important!

- The procedure below simply displays a value indicating your current altitude, without recording it in watch memory. For information about recording altitude readings in watch memory, see "Saving Altitude Readings in Memory".

To view your current altitude

Altitude change since Altimeter Mode stopwatch measurement started

Altitude graph

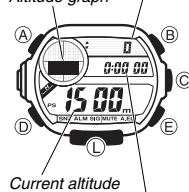

Current altitude

Altimeter Mode stopwatch elapsed time

- In the Timekeeping Mode, use the (C) button to enter the Altimeter Mode.
 - The watch will start altitude measurement and display the result.
 - It can take up to four or five seconds for the first altitude reading to appear.
- If you leave the watch in the Altimeter Mode, the current altitude value and the altitude change value will be updated according to the altitude reading interval.
 - If you want to restart the operation at any point, press (C).
- To stop taking altitude readings, press (D) to exit the Altimeter Mode.

Notes

- Normally, displayed altitude values are based on the watch's preset conversion values. You also can specify a reference altitude, if you want. See "Specifying a Reference Altitude".
- Altitude is displayed in units of 5 meters (20 feet).
- The measurement range for altitude is -700 to 10,000 meters (-2,300 to 32,800 feet).
- An altitude reading may be displayed be a negative value in cases where there is a reference altitude value specified or because of certain atmospheric conditions.
- The displayed altitude value changes to - - - - meters (or feet) if an altitude reading falls outside the measurement range. The altitude value will be displayed again as soon as the altitude reading is within the allowable range.
- You can select either meters (m) or feet (ft) as the measurement unit for displayed altitude value.
- During altitude measurements, the watch may not be able to update its timekeeping display contents normally. Correct timekeeping is maintained internally, however.

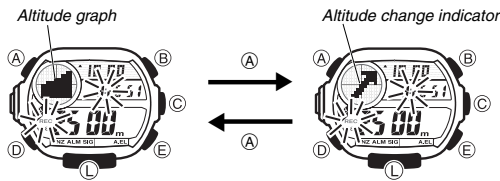

- In the Altimeter Mode, press the (A) button to toggle between the altitude graph and the altitude change indicator. The altitude change indicator shows the relative change between the latest altitude reading and the one before it.
- Nothing is displayed for the altitude change indicator when the current altitude reading is outside the watch's altitude measurement range (-700 to 10,000 meters/-2300 to 32,800 feet).

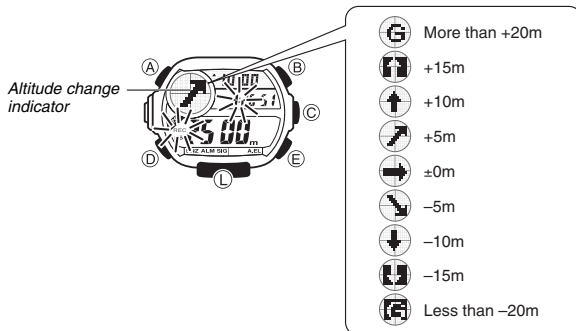

To specify the altitude reading interval

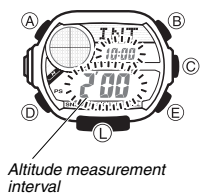

1. In the Altimeter Mode, hold down (A) for about two seconds until either **FFF** or the current reference altitude value starts to flash. This is the setting screen.
2. Press (D) to display the current altitude reading interval setting.
 - This will cause either **0'05"** or **2'00"** to flash on the display.
3. Press (A) to toggle the setting between **0'05"** and **2'00"**.
 - **0'05"**: Readings at five-second intervals for one hour
 - **2'00"**: Readings at five-second intervals for the first three minutes followed by two-minute intervals for 10 hours
4. Press (A) to exit the setting screen.

Saving Altitude Readings in Memory

- The following describes the different types of records the watch creates for altitude readings.
- You can take manual altitude readings, which are stored in memory along with the date (year, month, day) of the reading. There is enough memory to hold up to 20 altitude records (readings).
 - The Altimeter Mode has a stopwatch (which is independent of the watch's Stopwatch Mode) that you can use to time your climbs. While the Altimeter Mode stopwatch is running, the watch takes altitude readings automatically (without storing them in memory). Each time you reset the Altimeter Mode stopwatch to all zeros, the highest altitude, lowest altitude, cumulative ascent, and cumulative descent achieved during the last Altimeter Mode stopwatch session are stored in a "current stopwatch session record".
 - A separate "historical record" keeps track of the highest altitude, lowest altitude, cumulative ascent, and cumulative descent of all past Altimeter Mode stopwatch sessions.

To take a manual altitude reading

1. Press (C) to enter the Altimeter Mode.
2. Hold down (C) for about one second until **REC** flashes on the display.
 - At this time the watch will beep and the current altitude reading will be saved along with the current date (year, month, day) and time.
3. **REC** will stop flashing and the watch will return to the Altimeter Mode automatically after data save is complete.
- Memory can hold up to 20 altitude records. Storing a new reading while there already are 20 in memory will delete the oldest record to make room for the new reading.

To take altitude readings using the Altimeter Mode stopwatch

1. In the Timekeeping Mode, use the (C) button to enter the Altimeter Mode.
 - The watch will start altitude measurement automatically. Note that readings are not saved as altitude records.
2. Press the (E) button to start the Altimeter Mode stopwatch.
 - While an Altimeter Mode stopwatch operation is in progress, the display shows the elapsed time, current altitude, and the change in altitude since the start of the stopwatch operation.

3. After you are finished using the Altimeter Mode Stopwatch, reset it to all zeros.

- While an Altimeter Mode stopwatch operation is in progress, you can toggle between the altitude graph and the altitude change indicator by pressing the (A) button. The altitude change indicator graphically shows how the current altitude reading differs from the previous reading. The type of indicator that appears depends on the relative size of the altitude change.

Current Stopwatch Session Record

The current stopwatch session record contains the data described below. The contents of this record are retained until you start a new Altimeter Mode stopwatch measurement session.

Data	Description
High Altitude (M F X)	Highest altitude reached during the current Altimeter Mode stopwatch session.
Low Altitude (M I N)	Lowest altitude reached during the current Altimeter Mode stopwatch session.
Total Ascent (F S C)	Total cumulative ascent during the current Altimeter Mode stopwatch session.
Total Descent (D S C)	Total cumulative descent during the current Altimeter Mode stopwatch session.

- The maximum total ascent and total descent value is 99,995 meters (or 99,980 feet). Each value reverts to zero after the maximum is reached.

How current Altimeter Mode stopwatch session record data is updated

- Note**
- When you press (E) to start a new Altimeter Mode stopwatch session, the watch will clear data that is already stored in the current stopwatch session record.
 - The watch takes altitude readings and calculates data as described below, and updates the current stopwatch session record accordingly. Note that measurement and saves depend on whether or not the watch is in the Altimeter Mode.

• In the Altimeter Mode

Altitude Measurement Interval	First 3 minutes	After 3 minutes
0'05"	Updated every 5 seconds	Updated every 5 seconds
2'00"	Updated every 5 seconds	Updated every 2 minutes

• Outside the Altimeter Mode

Readings are taken and session data is updated every two minutes.

Historical Record

The historical record keeps track of high altitude, low altitude, total ascent, and total descent values across multiple Altimeter Mode stopwatch sessions. The contents of this record are updated continually while an Altimeter Mode stopwatch operation is in progress.

How the historical record is updated

The watch performs the following operations continually while an Altimeter Mode stopwatch operation is in progress.

Data	Update Operation
High Altitude	The historical record value is compared with the current reading and the greater of the two is recorded in the historical record.
Low Altitude	The historical record value is compared with the current reading, and the lesser of the two is recorded in the historical record.
Total Ascent	The current Altimeter Mode stopwatch session value is added to the historical record value.
Total Descent	

- See "Clearing the Historical Record" for information about clearing the historical record, which restarts all data values from zero.

Other Altimeter Mode Features

This section explains other features and settings that are available in the Altimeter Mode. Note that all of the information in this section applies to all types of Altimeter Mode measurements, unless specifically indicated otherwise.

Specifying a Reference Altitude

After you specify a reference altitude, the watch adjusts its air-pressure-to-altitude conversion calculation accordingly. The altitude measurements produced by this watch are subject to error caused by changes in air pressure. Because of this, we recommend that you update the reference altitude whenever one is available during your climb.

To specify a reference altitude

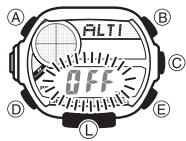

- In the Altimeter Mode, hold down (A) for about two seconds until either OFF or the current reference altitude value starts to flash. This is the setting screen.
- Press (E) (+) or (B) (-) to change the current reference altitude value by 5 meters (or 20 feet).
 - You can specify the reference altitude within the range of -10,000 to 10,000 meters (-32,800 to 32,800 feet).

- Pressing (E) and (B) at the same time returns to OFF (no reference altitude), so the watch performs air pressure to altitude conversions based on preset data only.

3. Press (A) to exit the setting screen.

Altitude graph

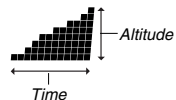

The altitude graph shows Altimeter Mode measurement results.

- The vertical axis of the graph represents altitude, and each dot stands for 10 meters (40 feet).

- The horizontal axis represents time, and the flashing dot in the rightmost column indicates the latest measurement result. For the first three minutes, each dot represents five seconds. After that, each dot represents two minutes.
- An out of range measurement result or a measurement error will cause the column of dots for that measurement to be blank (skipped).

Recalling Altitude Data

Use the Data Recall Mode to view altitude records currently in memory, as well as the current Altimeter Mode stopwatch session record, and the historical record. Altitude records are created and stored by the watch in the Altimeter Mode.

Data Screens

The following explains the contents of each of the screens that appear in the Data Recall Mode.

Note

- While an altitude record screen, or the high altitude or low altitude screen is displayed, the bottom part of the display alternates between the measurement date (month and day) and measurement time, at 1-second intervals.

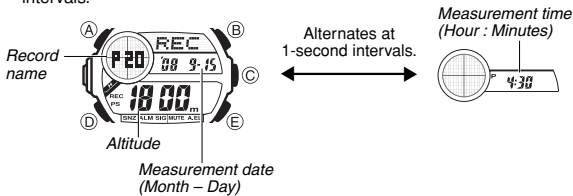

Altitude Records

These are records of the 20 newest altitude readings taken with the watch by you. If you take more than 20 readings, the watch will delete the oldest readings to make room for the newest readings.

Current Stopwatch Session Record

The following data items are included in the current stopwatch session record.

Data Type	Screen Name	Description
High Altitude	MAX	Highest altitude reached during the last Altimeter Mode stopwatch session.
Low Altitude	MIN	Lowest altitude reached during the last Altimeter Mode session.
Total Ascent	ASC	Total cumulative ascent during the last Altimeter Mode session.
Total Descent	DSC	Total cumulative descent during the last Altimeter Mode session.

Historical Record

The historical record contains data for all Altimeter Mode stopwatch sessions performed since the last time the historical record was cleared.

Data Type	Screen Name	Description
High Altitude	MAX	Highest altitude reached during all Altimeter Mode stopwatch sessions.
Low Altitude	MIN	Lowest altitude reached during all Altimeter Mode stopwatch sessions.
Total Ascent	ASC	Total cumulative ascent during all Altimeter Mode stopwatch sessions.
Total Descent	DSC	Total cumulative descent during all Altimeter Mode stopwatch sessions.

To view altitude records and the current Altimeter Mode stopwatch session record

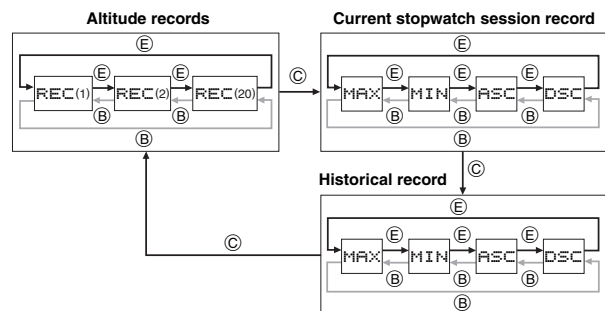

- Enter the Data Recall Mode.
 - Use the (C) button to cycle between the altitude records, current Altimeter Mode stopwatch record, and the historical record.
 - When the record you want is displayed, use the (E) (+) button and (B) (-) button to scroll through the data. Holding down the (E) or (B) button scrolls data at high speed.
 - After you are finished viewing data, press (D) to exit the Data Recall Mode.
- Dashes (---) will be displayed if data has been deleted or if there is no corresponding data due to error, etc. In such cases, total ascent (ASC) and total descent (DSC) values will show zero.
 - When total ascent (ASC) or total descent (DSC) exceeds 99,995 meters (or 99,980 feet), the applicable value will restart from zero.

Clearing the Historical Record

Use the following procedure to clear the contents of the historical record and restart all values from zero.

To clear the historical record

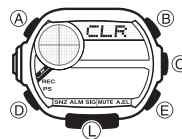

- Press the (D) button to enter the Data Recall Mode.
 - Hold down (A).
 - CLR will appear in the upper part of the display.
 - Keep (A) held down for an additional two seconds until CLR starts flashing.
- The historical record high altitude screen will reappear when data deletion is complete.
 - If you release the (A) button part way through the above procedure, the watch will return to the historical record high altitude screen without deleting the data.

Barometer/Thermometer

This watch uses a pressure sensor to measure air pressure (barometric pressure) and a temperature sensor to measure temperature.

- You can calibrate the pressure sensor and the temperature sensor if you suspect that readings are incorrect.

To take barometric pressure and temperature readings

Barometric pressure graph

Barometric pressure

Temperature

In the Timekeeping Mode, press the (D) button to enter the Barometer/Thermometer Mode. This will start barometric pressure and temperature measurements automatically.



- It can take up to four or five seconds for the barometric pressure reading to appear after you enter the Barometer/Thermometer Mode.
- Barometric pressure is displayed in units of 1hPa (or 0.05 inHg).

- The displayed barometric pressure value changes to --- hPa (or inHg) if a measured barometric pressure falls outside the range of 260 hPa to 1100 hPa (7.65 inHg to 32.45 inHg). The barometric pressure value will reappear as soon as the measured barometric pressure is within the allowable range.
- Temperature is displayed in units of 0.1°C (or 0.2°F).
- The displayed temperature value changes to --- °C (or °F) if a measured temperature falls outside the range of -10.0°C to 60.0°C (14.0°F to 140.0°F). The temperature value will reappear as soon as the measured temperature is within the allowable range.
- In some areas, barometric pressure is expressed in millibars (mb) instead of hectopascals (hPa). It really makes no difference, because 1hPa = 1mb.
- You can select either hectopascals (hPa) or inchesHg (inHg) as the display unit for the measured barometric pressure, and Celsius (°C) or Fahrenheit (°F) as the display unit for the measured temperature value. See "To select the temperature, barometric pressure, and altitude units".
- See "Barometer and Thermometer Precautions" for important precautions.

Barometric Pressure Graph

Barometric pressure indicates changes in the atmosphere. By monitoring these changes you can predict the weather with reasonable accuracy. This watch takes barometric pressure measurements automatically every two hours (at the top of each even-numbered hour), regardless of its current mode. Measurement results are used to produce barometric pressure graph and barometric pressure change indicator readings. The barometric pressure graph shows readings of previous measurements for up to 24 hours. The horizontal axis of the graph represents time, with each dot standing for two hours. The rightmost dot represents the most recent reading. The vertical axis of the graph represents barometric pressure, with each dot standing for the relative difference between its reading and that of the dots next to it. Each dot represents 1hPa. The following shows how to interpret the data that appears on the barometric pressure graph.



A rising graph generally means improving weather.



A falling graph generally means deteriorating weather.

Note that if there are sudden changes in weather or temperature, the graph line of past measurements may run off the top or bottom of the display. The entire graph will become visible once barometric conditions stabilize. The following conditions cause the barometric pressure measurement to be skipped, with the corresponding point on the barometric pressure graph being left blank.

- Barometric reading that is out of range (260 hPa/mb to 1,100 hPa/mb or 7.65 inHg to 32.45 inHg)
- Sensor malfunction

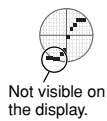

Not visible on the display.

Barometric Pressure Change Indicator

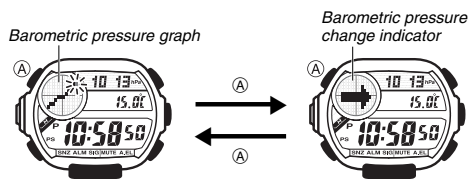

In the Barometer/Thermometer Mode, press the (A) button to toggle between the barometric pressure graph and the barometric pressure change indicator. This indicator (→) indicates the relative difference between the most recent barometric pressure reading indicated on the barometric pressure graph, and the current barometric pressure value displayed in the Barometer/Thermometer Mode.

- Pressure differential is indicated in the range of ±4 hPa, in 1-hPa units.
- The barometric pressure change indicator (→) is not displayed when the displayed current barometric value is outside of the allowable measurement range (260 to 1,100 hPa).
- Barometric pressure is calculated and displayed using hPa as the standard. The barometric pressure differential also can be read in inHg units as shown in the illustration.

Barometric pressure change indicator

hPa or inHg

- More than +4hPa
- +3hPa
- +2hPa
- +1hPa
- ±0hPa
- 1hPa
- 2hPa
- 3hPa
- Less than -4hPa

About Barometric and Temperature Measurements

- Barometric pressure and temperature measurement operations are performed as soon as you enter the Barometer/Thermometer Mode. After that, barometric pressure and temperature measurements are taken every five seconds.
- During barometric pressure measurements, the watch may not be able to update its timekeeping display contents normally. Correct timekeeping is maintained internally, however.

World Time

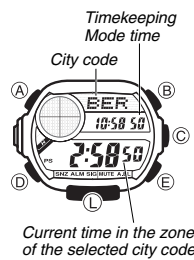

World Time displays the current time in 33 cities (29 time zones) around the world.

- If the current time shown for a city is wrong, check your Home City time settings and make the necessary changes.
- For full information on city codes, see the "City Code Table".
- All of the operations in this section are performed in the World Time Mode, which you enter by pressing (D).

To view the time in another city

In the World Time Mode, use (E) (east) and (B) (west) to scroll through city codes (time zones).

- When the currently selected time zone is one that includes mostly ocean, a value indicating the zone's UTC offset appears in place of a city code.

To toggle a city code time between Standard Time and Daylight Saving Time

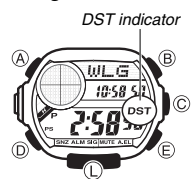

- In the World Time Mode, use (E) (east) and (B) (west) to display the city code (time zone) whose Standard Time/Daylight Saving Time setting you want to change.
 - Hold down (A) to toggle between Daylight Saving Time (DST indicator displayed) and Standard Time (DST indicator not displayed).
- The DST indicator appears on the display whenever you display a city code for which Daylight Saving Time is turned on.

- You cannot toggle between Daylight Saving Time and Standard Time if the displayed city code is UTC (UTC offset: 0).
- Note that the DST/Standard Time setting affects only the currently displayed city code. Other city codes are not affected.

Stopwatch

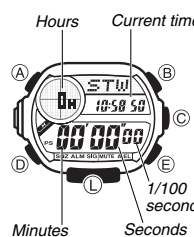

The stopwatch lets you measure elapsed time, split times, and two finishes.

- The Stopwatch Mode is independent of the Altimeter Mode stopwatch.
- The display range of the stopwatch is 23 hours, 59 minutes, 59.99 seconds.
- The stopwatch continues to run, restarting from zero after it reaches its limit, until you stop it.
- The stopwatch measurement operation continues even if you exit the Stopwatch Mode.
- Exiting the Stopwatch Mode while a split time is frozen on the display clears the split time and returns to elapsed time measurement.
- All of the operations in this section are performed in the Stopwatch Mode, which you enter by pressing (D).

To measure times with the stopwatch

Elapsed Time

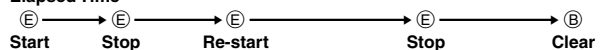

Split Time

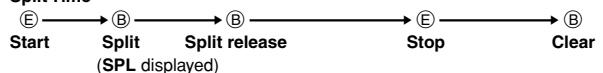

Two Finishes



Countdown Timer

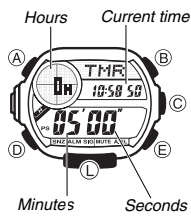

You can set the countdown timer within a range of one minute to 24 hours. An alarm sounds when the countdown reaches zero.

- All of the operations in this section are performed in the Countdown Timer Mode, which you enter by pressing **D**.

To set the countdown start time

- While the countdown start time is on the display in the Countdown Timer Mode, hold down **A** until the hour setting of the countdown start time starts to flash, which indicates the setting screen.
 - If the countdown start time is not displayed, use the procedure under "To use the countdown timer" to display it.

- Press **D** to move the flashing between the hour and minute settings.
- Use **E** (+) and **B** (-) to change the flashing item.
 - To set the starting value of the countdown time to 24 hours, set **00 00 00**.
- Press **A** to exit the setting screen.

To use the countdown timer

- Press **E** while in the Countdown Timer Mode to start the countdown timer.
- When the end of the countdown is reached, the alarm sounds for five seconds or until you stop it by pressing any button. The countdown time is reset to its starting value automatically when the alarm sounds.
 - Press **E** while a countdown operation is in progress to pause it. Press **E** again to resume the countdown.
 - To stop a countdown operation completely, first pause it (by pressing **E**) and then press **B**. This returns the countdown time to its starting value.

Alarms

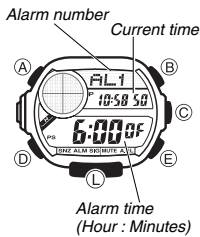

The Alarm Mode gives you a choice of four one-time alarms and one snooze alarm. Also use the Alarm Mode to turn the Hourly Time Signal (**SIG**) on and off.

- There are five alarms numbered **AL1** through **AL4**, and **SNZ**. You can configure **SNZ** as a snooze alarm only. Alarms **AL1** through **AL4** can be used as one-time alarms only.
- When you enter the Alarm Mode, the data you were viewing when you last exited the mode appears first.
- All of the operations in this section are performed in the Alarm Mode, which you enter by pressing **D**.

To set an alarm time

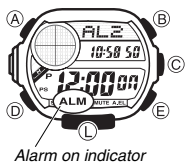

- In the Alarm Mode, use **E** and **B** to scroll through the alarm screens until the one whose time you want to set is displayed.

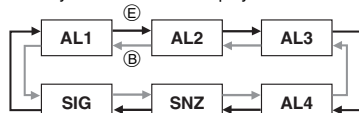

- Hold down **A** until the hour setting of the alarm time starts to flash, which indicates the setting screen.
 - This automatically turns on the alarm.
- Press **D** to move the flashing between the hour and minute settings.
- While a setting is flashing, use **E** (+) and **B** (-) to change it.
 - When setting the alarm time using the 12-hour format, take care to set the time correctly as a.m. (no indicator) or p.m. (**P** indicator).
- Press **A** to exit the setting screen.

Alarm Operation

The alarm tone sounds at the preset time for 10 seconds, regardless of the mode the watch is in. In the case of the snooze alarm, the alarm operation is performed a total of seven times, every five minutes, until you turn the alarm off.

- Alarm and Hourly Time Signal operations are performed in accordance with the Timekeeping Mode time.
- To stop the alarm tone after it starts to sound, press any button.
- Performing any one of the following operations during a 5-minute interval between snooze alarms cancels the current snooze alarm operation.
 - Displaying the Timekeeping Mode setting screen
 - Displaying the **SNZ** setting screen

To test the alarm

In the Alarm Mode, hold down **E** to sound the alarm.

To turn an alarm and the Hourly Time Signal on and off

- In the Alarm Mode, use **E** and **B** to select an alarm or the Hourly Time Signal.
- When the alarm or the Hourly Time Signal you want is selected, press **C** to toggle it on and off.
 - ALM** indicates alarm is on.
 - SIG** indicates Hourly Time Signal is on.
- The alarm on indicator (**ALM**) and the Hourly Time Signal on indicator (**SIG**) are shown on the display in all modes while these functions are turned on.
- If any alarm is on, the alarm on indicator is shown on the display in all modes.

Illumination

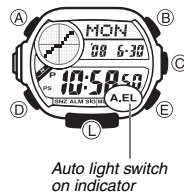

The display of the watch is illuminated using an EL (electro-luminescent) panel for easy reading in the dark. The watch's auto light switch turns on illumination automatically when you angle the watch towards your face.

- The auto light switch must be turned on (indicated by the auto light switch on indicator) for it to operate.
- See "Illumination Precautions" for other important information about using illumination.

To turn on illumination manually

- Press **L** in any mode to illuminate the display for about one second.
- The above operation turns on illumination regardless of the current auto light switch setting.
 - Illumination is disabled while configuring sensor measurement mode settings.

About the Auto Light Switch

Turning on the auto light switch causes illumination to turn on, whenever you position your wrist as described below in any mode. Note that this watch features a "Full Auto EL Light", so the auto light switch operates only when available light is below a certain level. It does not illuminate the display under bright light.

- The auto light switch is always disabled, regardless of its on/off setting, when any one of the following conditions exists.

While an alarm is sounding
During sensor measurement

Moving the watch to a position that is parallel to the ground and then tilting it towards you more than 40 degrees causes illumination to turn on.

- Wear the watch on the outside of your wrist.

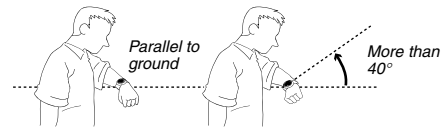

Warning!

- Always make sure you are in a safe place whenever you are reading the display of the watch using the auto light switch. Be especially careful when running or engaged in any other activity that can result in accident or injury. Also take care that sudden illumination by the auto light switch does not startle or distract others around you.
- When you are wearing the watch, make sure that its auto light switch is turned off before riding on a bicycle or operating a motorcycle or any other motor vehicle. Sudden and unintended operation of the auto light switch can create a distraction, which can result in a traffic accident and serious personal injury.

To turn the auto light switch on and off

In the Timekeeping Mode, hold down **L** for about three seconds to toggle the auto light switch on (**A.EL** displayed) and off (**A.EL** not displayed).

- The auto light switch on indicator (**A.EL**) is on the display in all modes while the auto light switch is turned on.
- The auto light switch turns off automatically whenever battery power drops to Level 3.
- Illumination may not turn on right away if you raise the watch to your face while a barometric pressure or altitude measurement operation is in progress.

Questions & Answers

Question: How does the barometer work?

Answer: Barometric pressure indicates changes in the atmosphere, and by monitoring these changes you can predict the weather with reasonable accuracy. Rising atmospheric pressure indicates good weather, while falling pressure indicates deteriorating weather conditions.

The barometric pressures that you see in the newspaper and on the TV weather report are measurements corrected to values measured at 0 m sea level.

Question: How does the altimeter work?

Answer: Generally, air pressure and temperature decrease as altitude increases. This watch bases its altitude measurements on International Standard Atmosphere (ISA) values stipulated by the International Civil Aviation Organization (ICAO). These values define relationships between altitude, air pressure, and temperature.

Altitude	Air Pressure	Temperature
4000 m	616 hPa	-11°C
3500 m	701 hPa	-4.5°C
3000 m		
2500 m	795 hPa	2°C
2000 m		
1500 m	899 hPa	8.5°C
1000 m		
500 m	1013 hPa	15°C
0 m		

About 8 hPa per 100 m
 About 9 hPa per 100 m
 About 10 hPa per 100 m
 About 11 hPa per 100 m
 About 12 hPa per 100 m
 About 6.5°C per 1000 ft

Altitude	Air Pressure	Temperature
14000 ft	19.03 inHg	16.2°F
12000 ft	22.23 inHg	30.5°F
10000 ft		
8000 ft	25.84 inHg	44.7°F
6000 ft		
4000 ft	29.92 inHg	59.0°F
2000 ft		
0 ft		

About 0.15 inHg per 200 ft
 About 0.17 inHg per 200 ft
 About 0.192 inHg per 200 ft
 About 0.21 inHg per 200 ft
 About 3.6°F per 1000 ft

Source: International Civil Aviation Organization

- Note that the following conditions will prevent you from obtaining accurate readings:

When air pressure changes because of changes in the weather
Extreme temperature changes

When the watch itself is subjected to strong impact

There are two standard methods of expressing altitude: Absolute altitude and relative altitude. Absolute altitude expresses an absolute height above sea level. Relative altitude expresses the difference between the height of two different places.

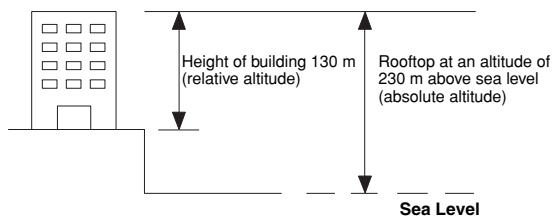

Precautions Concerning Simultaneous Measurement of Altitude and Temperature

Though you can perform altitude and temperature measurements at the same time, you should remember that each of these measurements requires different conditions for best results. With temperature measurement, it is best to remove the watch from your wrist in order to eliminate the effects of body heat. In the case of altitude measurement, on the other hand, it is better to leave the watch on your wrist, because doing so keeps the watch at a constant temperature, which contributes to more accurate altitude measurements.

- To give altitude measurement priority, leave the watch on your wrist or in any other location where the temperature of the watch is kept constant.
- To give temperature measurement priority, remove the watch from your wrist and allow it to hang freely from your bag or in another location where it is not exposed to direct sunlight. Note that removing the watch from your wrist can affect pressure sensor readings momentarily.

Power Supply

This watch is equipped with a solar cell and a special rechargeable battery (secondary battery) that is charged by the electrical power produced by the solar cell. The illustration shown below shows how you should position the watch for charging.

Example: Orient the watch so its face is pointing at a light source.

- The illustration shows how to position a watch with a resin band.
- Note that charging efficiency drops when any part of the solar cell is blocked by clothing, etc.
- You should try to keep the watch outside of your sleeve as much as possible. Charging is reduced significantly if the face is covered only partially.

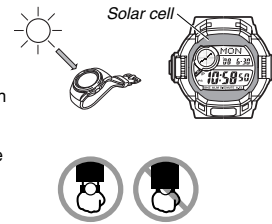

Important!

- Storing the watch for long periods in an area where there is no light or wearing it in such a way that it is blocked from exposure to light can cause rechargeable battery power to run down. Be sure that the watch is exposed to bright light whenever possible.
- This watch uses a special rechargeable battery to store power produced by the solar cell, so regular battery replacement is not required. However, after very long use, the rechargeable battery may lose its ability to achieve a full charge. If you experience problems getting the special rechargeable battery to charge fully, contact your dealer or CASIO distributor about having it replaced.
- Never try to remove or replace the watch's special battery yourself. Use of the wrong type of battery can damage the watch.
- All data stored in memory is deleted, and the current time and all other settings return to their initial factory defaults whenever battery power drops to Level 5 and when you have the battery replaced.
- Turn on the watch's Power Saving function and keep it in an area normally exposed to bright light when storing it for long periods. This helps to keep the rechargeable battery from going dead.

Battery Power Indicator and Recover Indicator

The battery power indicator on the display shows you the current status of the rechargeable battery's power.



Battery power indicator

Level	Battery Power Indicator	Function Status
1		All functions enabled.
2		All functions enabled.
3	(Charge Soon Alert)	Illumination, beeper, and sensor operation disabled.
4		Except for timekeeping and the C (charge) indicator, all functions and display indicators disabled.
5		All functions disabled.

- The flashing indicator at Level 3 tells you that battery power is very low, and that exposure to bright light for charging is required as soon as possible.
- At Level 5, all functions are disabled and settings return to their initial factory defaults. Once the battery reaches Level 2 (indicated by **M** indicator) after falling to Level 5, reconfigure the current time, date, and other settings.
- Display indicators reappear as soon as the battery is charged from Level 5 to Level 2.
- Leaving the watch exposed to direct sunlight or some other very strong light source can cause the battery power indicator to show a reading temporarily that is higher than the actual battery level. The correct battery level should be indicated after a few minutes.



Recover indicator

- Performing multiple sensor, illumination, or beeper operations during a short period may cause **LMH** (recover) to appear on the display. Illumination, alarm, countdown timer alarm, hourly time signal, and sensor operations will be disabled until battery power recovers. After some time, battery power will recover and **LMH** (recover) will disappear, indicating that the above functions are enabled again.
- Even if battery power is at Level 1 or Level 2, the Barometer/Thermometer Mode or Altimeter Mode sensor may be disabled if there is not enough voltage available to power it sufficiently. This is indicated by **LMH** (recover) on the display.
- If **LMH** (recover) appears frequently, it probably means that remaining battery power is low. Leave the watch in bright light to allow it to charge.

Charging Precautions

Certain charging conditions can cause the watch to become very hot. Avoid leaving the watch in the areas described below whenever charging its rechargeable battery. Also note that allowing the watch to become very hot can cause its liquid crystal display to black out. The appearance of the LCD should become normal again when the watch returns to a lower temperature.

Warning!

Leaving the watch in bright light to charge its rechargeable battery can cause it to become quite hot. Take care when handling the watch to avoid burn injury. The watch can become particularly hot when exposed to the following conditions for long periods.

- On the dashboard of a car parked in direct sunlight
- Too close to an incandescent lamp
- Under direct sunlight

Charging Guide

After a full charge, timekeeping remains enabled for up to about five months. The following table shows the amount of time the watch needs to be exposed to light each day in order to generate enough power for normal daily operations.

Exposure Level (Brightness)	Approximate Exposure Time
Outdoor Sunlight (50,000 lux)	5 minutes
Sunlight Through a Window (10,000 lux)	24 minutes
Daylight Through a Window on a Cloudy Day (5,000 lux)	48 minutes
Indoor Fluorescent Lighting (500 lux)	8 hours

- Since these are the specs, we can include all the technical details.
 - Watch not exposed to light
 - Internal timekeeping
 - Display on 18 hours per day, sleep state 6 hours per day
 - 1 illumination operation (1.5 seconds) per day
 - 10 seconds of alarm operation per day
 - 1 hour of altimeter measurement at 5-second interval, once per month
 - 2 hours of barometric pressure measurement per day
- Stable operation is promoted by frequent exposure to light.

Recovery Times

The table below shows the amount exposure that is required to take the battery from one level to the next.

Exposure Level (Brightness)	Approximate Exposure Time				
	Level 5	Level 4	Level 3	Level 2	Level 1
Outdoor Sunlight (50,000 lux)	1 hour		14 hours	4 hours	
Sunlight Through a Window (10,000 lux)	4 hours		69 hours	19 hours	
Daylight Through a Window on a Cloudy Day (5,000 lux)	6 hours		139 hours	38 hours	
Indoor Fluorescent Lighting (500 lux)	62 hours		-----	-----	

- The above exposure time values are all for reference only. Actual required exposure times depend on lighting conditions.

Reference

This section contains more detailed and technical information about watch operation. It also contains important precautions and notes about the various features and functions of this watch.

Auto Return Features

- The watch returns to the Timekeeping Mode automatically if you do not perform any button operation for two or three minutes in the Data Recall, Alarm, or Barometer/Thermometer Mode.
- If you do not perform any button operation for 21 or 22 hours while in the Altimeter Mode, the watch will return to the Timekeeping Mode automatically.
- If you leave a screen with flashing digits on the display for two or three minutes without performing any operation, the watch exits the setting screen automatically.

Initial Screens

When you enter the World Time or Alarm Mode, the data you were viewing when you last exited the mode appears first.

Scrolling

The **(L)** and **(R)** buttons are used on the setting screen to scroll through data on the display. In most cases, holding down these buttons during a scroll operation scrolls through the data at high speed.

Sensor Malfunction Indicator

Subjecting the watch to strong impact can cause sensor malfunction or improper contact of internal circuitry. When this happens, **ERR** (error) will appear on the display and sensor operations will be disabled.

Barometric Pressure Measurement

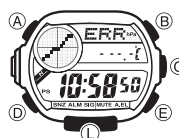

Altitude Measurement

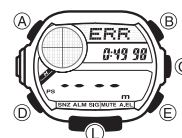

- If **ERR** appears while a measurement operation is being performed in a sensor mode, restart the measurement. If **ERR** appears on the display again, it can mean there is something wrong with the sensor.
- Even if battery power is at Level 1 or Level 2, the Barometer/Thermometer Mode or Altimeter Mode sensor may be disabled if there is not enough voltage available to power it sufficiently. In this case, **ERR** will appear on the display. This does not indicate malfunction, and sensor operation should resume once battery voltage returns to its normal level.
- If **ERR** keeps appearing during measurement, it could mean there is a problem with the applicable sensor.

Whenever you have a sensor malfunction, be sure to take the watch to your original dealer or nearest authorized CASIO distributor as soon as possible.

Button Operation Tone



Mute indicator

The button operation tone sounds any time you press one of the watch's buttons. You can turn the button operation tone on or off as desired.

- Even if you turn off the button operation tone, the alarm, Hourly Time Signal, and Countdown Timer Mode alarm all operate normally.

To turn the button operation tone on and off

In any mode (except when a setting screen is on the display), hold down **(D)** to toggle the button operation tone on (**MUTE** not displayed) and off (**MUTE** displayed).

- Since the **(D)** button is also the mode change button, holding it down to turn the button operation on or off also causes the watch's current mode to change.
- The **MUTE** indicator is displayed in all modes when the button operation tone is turned off.

Power Saving

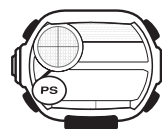

When turned on, Power Saving enters a sleep state automatically whenever the watch is left for a certain period in an area where it is dark. The table below shows how watch functions are affected by Power Saving.

- There actually are two sleep state levels: "display sleep" and "function sleep".

Elapsed Time in Dark	Display	Operation
60 to 70 minutes (Display Sleep)	Blank, with PS flashing	Display is off, but all functions are enabled.
6 or 7 days (Function Sleep)	Blank, with PS not flashing	All functions are disabled, but timekeeping is maintained.

- Wearing the watch inside the sleeve of clothing can cause it to enter the sleep state.
- The watch will not enter the sleep state while the digital time is between 6:00 AM and 9:59 PM. If the watch is already in the sleep state when the digital time reaches 6:00 AM, however, it will remain in the sleep state.
- The watch will not enter the sleep state while it is in the Barometer/Thermometer, Altimeter, Countdown Timer, or Stopwatch Mode. When the watch is left in any mode besides the Countdown Timer and Stopwatch Mode, the watch will return to the Timekeeping Mode automatically after a specific amount of time. Then if left in the dark for the elapsed time indicated in the table above, the watch will enter the sleep state.

To recover from the sleep state

Perform any one of the following operations.

- Move the watch to a well-lit area. It can take up to two seconds for the display to turn on.
- Press any button.
- Angle the watch towards your face for reading.

To turn Power Saving on and off

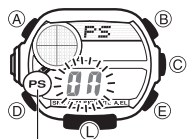

Power Saving on indicator

1. In the Timekeeping Mode, hold down (A) until the city code starts to flash, which indicates the setting screen.
 2. Press (D) nine times until the Power Saving on/off screen appears.
 3. Press (E) to toggle Power Saving on (PS) and off (PSF).
 4. Press (A) to exit the setting screen.
- The Power Saving on indicator (PS) is on the display in all modes while Power Saving is turned on.

Timekeeping

- Resetting the seconds to 00 while the current count is in the range of 30 to 59 causes the minutes to be increased by 1. In the range of 00 to 29, the seconds are reset to 00 without changing the minutes.
- With the 12-hour format, the P (PM) indicator appears on the display for times in the range of noon to 11:59 p.m. and no indicator appears for times in the range of midnight to 11:59 a.m.
- With the 24-hour format, times are displayed in the range of 0:00 to 23:59, without any indicator.
- The 12-hour/24-hour timekeeping format you select in the Timekeeping Mode is applied in all modes.
- The watch's built-in full automatic calendar makes allowances for different month lengths and leap years. Once you set the date, there should be no reason to change it except when battery power drops to Level 5.
- The current time for all city codes in the Timekeeping Mode and World Time Mode is calculated in accordance with the Coordinated Universal Time (UTC) for each city, based on your Home City time setting.
- The UTC offset is a value that indicates the time difference between a reference point in Greenwich, England and the time zone where a city is located.
- The letters "UTC" is the abbreviation for "Coordinated Universal Time", which is the world-wide scientific standard of timekeeping. It is based upon carefully maintained atomic (cesium) clocks that keep time accurately to within microseconds. Leap seconds are added or subtracted as necessary to keep UTC in sync with the Earth's rotation.

Illumination Precautions

- The electro-luminescent panel that provides illumination loses power after very long use.
- Illumination may be hard to see when viewed under direct sunlight.
- Illumination turns off automatically whenever an alarm sounds.
- The watch may emit an audible sound whenever the display is illuminated. This is due to vibration of the EL panel used for illumination, and does not indicate malfunction.
- Frequent use of illumination runs down the battery.

Auto light switch precautions

- The auto light switch is turned off automatically whenever battery power is at Level 4.
- Wearing the watch on the inside of your wrist, movement of your arm, or vibration of your arm can cause frequent activation of the auto light switch and illumination of the display. To avoid running down the battery, turn off the auto light switch whenever engaging in activities that might cause frequent illumination of the display.
- Note that wearing the watch under your sleeve while the auto light switch is turned on can cause frequent illumination of the display and can run down the battery.

More than 15 degrees too high



- Illumination may not turn on if the face of the watch is more than 15 degrees above or below parallel. Make sure that the back of your hand is parallel to the ground.
- Illumination turns off in about one second, even if you keep the watch pointed towards your face.

- Static electricity or magnetic force can interfere with proper operation of the auto light switch. If illumination does not turn on, try moving the watch back to the starting position (parallel with the ground) and then tilt it back towards your face again. If this does not work, drop your arm all the way down so it hangs at your side, and then bring it back up again.
- Under certain conditions, illumination does not turn on until about one second after you turn the face of the watch towards you. This does not necessarily indicate malfunction.
- You may notice a very faint clicking sound coming from the watch when it is shaken back and forth. This sound is caused by mechanical operation of the auto light switch, and does not indicate a problem with the watch.

Barometer and Thermometer Precautions

- The pressure sensor built into this watch measures changes in air pressure, which you can then apply to your own weather predictions. It is not intended for use as a precision instrument in official weather prediction or reporting applications.
- Sudden temperature changes can affect pressure sensor readings.
- Temperature measurements are affected by your body temperature (while you are wearing the watch), direct sunlight, and moisture. To achieve a more accurate temperature measurement, remove the watch from your wrist, place it in a well ventilated location out of direct sunlight, and wipe all moisture from the case. It takes approximately 20 to 30 minutes for the case of the watch to reach the actual surrounding temperature.

Pressure Sensor and Temperature Sensor Calibration

The pressure sensor and temperature sensor built into the watch are calibrated at the factory and normally require no further adjustment. If you notice serious errors in the pressure readings and temperature readings produced by the watch, you can calibrate the sensor to correct the errors.

Important!

- Incorrectly calibrating the barometric pressure sensor can result in incorrect readings. Before performing the calibration procedure, compare the readings produced by the watch with those of another reliable and accurate barometer.
- Incorrectly calibrating the temperature sensor can result in incorrect readings. Carefully read the following before doing anything.

Compare the readings produced by the watch with those of another reliable and accurate thermometer.

If adjustment is required, remove the watch from your wrist and wait for 20 or 30 minutes to give the temperature of the watch time to stabilize before adjusting.

To calibrate the pressure sensor and the temperature sensor

1. Press (D) to enter the Barometer/Thermometer Mode.
2. In the Barometer/Thermometer Mode, hold down (A) for about two seconds until either OFF or the current temperature calibration value starts to flash. This is the setting screen.
 - If you want to calibrate the barometric pressure sensor, press (D) to move the flashing to the middle display area. This is the pressure sensor calibration screen.



3. Use (E) (+) and (B) (-) to set the calibration value in the units shown below.

Temperature	0.1°C (0.2°F)
Barometric Pressure	1 hPa (0.05 inHg)

 - Pressing (E) and (B) at the same time returns to the factory calibration (OFF).
4. Press (A) to return to the Barometer/Thermometer Mode screen.

To select the temperature, barometric pressure, and altitude units

1. Enter the Timekeeping Mode.
2. Hold down (A) until the city code starts to flash, which indicates the setting screen.
3. Use (D) to select the setting screen for the unit you want to change.
 - See step 3 under "To set the time and date" for information about how to scroll through setting screens.
4. Press (E) to change the unit setting.
 - Each press of (E) changes the selected unit setting as shown below.

Temperature	°C and °F
Barometric Pressure	hPa and inHg
Altitude	m and ft
5. After the settings are the way you want, press (A) to exit the setting screen.

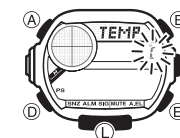

City Code Table

City Code	City	UTC offset	Other major cities in same time zone
PPG	Pago Pago	-11.0	
HNL	Honolulu	-10.0	Papeete
ANC	Anchorage	-09.0	Nome
LAX	Los Angeles	-08.0	San Francisco, Las Vegas, Vancouver, Seattle/Tacoma, Dawson City, Tijuana
DEN	Denver	-07.0	El Paso, Edmonton, Culiacan
CHI	Chicago	-06.0	Houston, Dallas/Fort Worth, New Orleans, Mexico City, Winnipeg
NYC	New York	-05.0	Montreal, Detroit, Miami, Boston, Panama City, Havana, Lima, Bogota
SCL	Santiago	-04.0	La Paz, Port Of Spain
RIO	Rio De Janeiro	-03.0	Sao Paulo, Buenos Aires, Brasilia, Montevideo
FEN	Fernando de Noronha	-02.0	
RAI	Praia	-01.0	
UTC		—	
LON	London	+00.0	Dublin, Lisbon, Casablanca, Dakar, Abidjan
PAR	Paris	+01.0	Milan, Rome, Madrid, Amsterdam, Algiers, Hamburg, Frankfurt, Vienna, Stockholm
BER	Berlin		
ATH	Athens	+02.0	Helsinki, Istanbul, Beirut, Damascus, Cape Town
CAI	Cairo		
JRS	Jerusalem		
JED	Jeddah	+03.0	Kuwait, Riyadh, Aden, Addis Ababa, Nairobi, Moscow
THR	Tehran	+03.5	Shiraz
DXB	Dubai	+04.0	Abu Dhabi, Muscat
KBL	Kabul	+04.5	
KHI	Karachi	+05.0	Male
DEL	Delhi	+05.5	Mumbai, Kolkata, Colombo
DAC	Dhaka	+06.0	
RGN	Yangon	+06.5	
BKK	Bangkok	+07.0	Jakarta, Phnom Penh, Hanoi, Vientiane
HKG	Hong Kong	+08.0	Singapore, Kuala Lumpur, Beijing, Manila, Perth, Ulaanbaatar
TPE	Taipei		
TYO	Tokyo	+09.0	Pyeongyang, Seoul
ADL	Adelaide	+09.5	Darwin
SYD	Sydney	+10.0	Melbourne, Guam, Rabaul
NOU	Noumea	+11.0	Port Vila
WLG	Wellington	+12.0	Christchurch, Nadi, Nauru Island

- Based on data as of June 2007.
- UTC offsets and the use of summer time are subject to change in the country where they are used.