

**CITIZEN WATCH CO., LTD.**

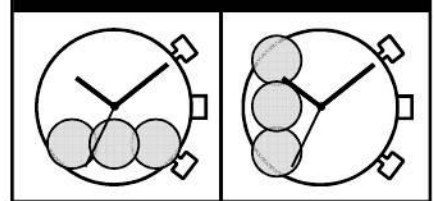

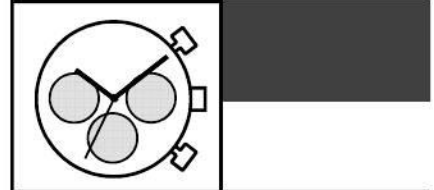

This drawing is provisional and subject to our reconfirmation and/or revision without notice.

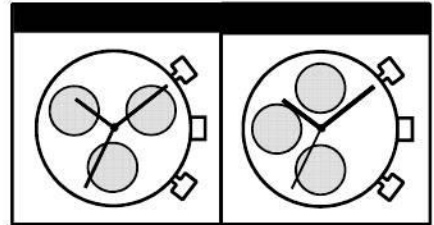
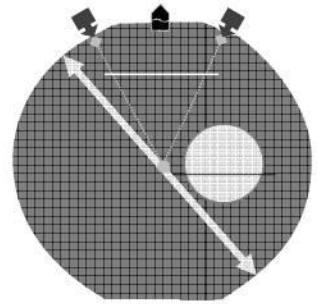
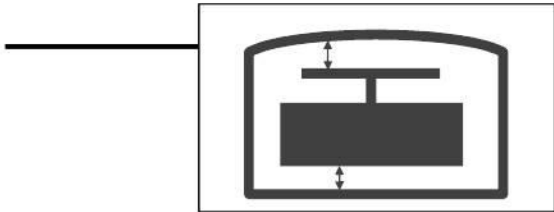
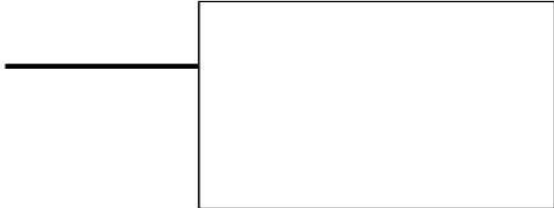
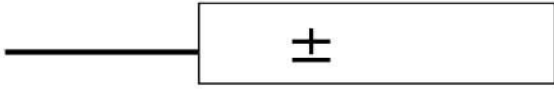
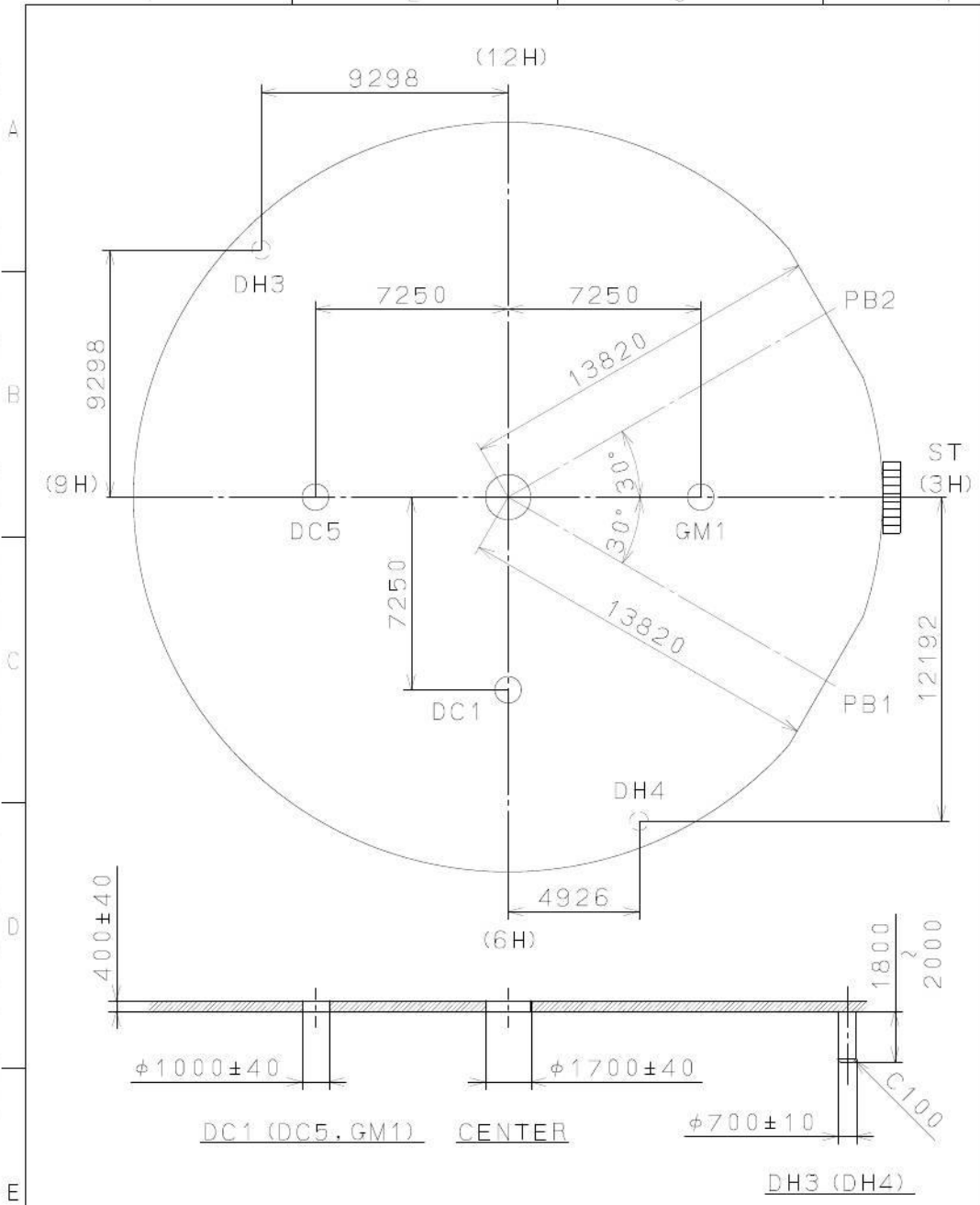

△			Quantity		Cal. NO.:
△			Unit	1/1000mm	JS20-00C
△			Scale	5:1	Parts No.:
△			Date		
△			Drawn		
Material			Checked	N. Suzuki	Name:
Heat Treatment			Approved		Indications for Dial
Hardness					Drawing No.: JS200001
Plating					
			General Tolerances		<b>MIYOTA</b>
			Dimensions		
			Angles		
					CITIZEN WATCH CO., LTD., TOKYO, JAPAN

2006/12/25 (07:50:10)

This drawing is provisional and subject to our reconfirmation and/or revision without notice.

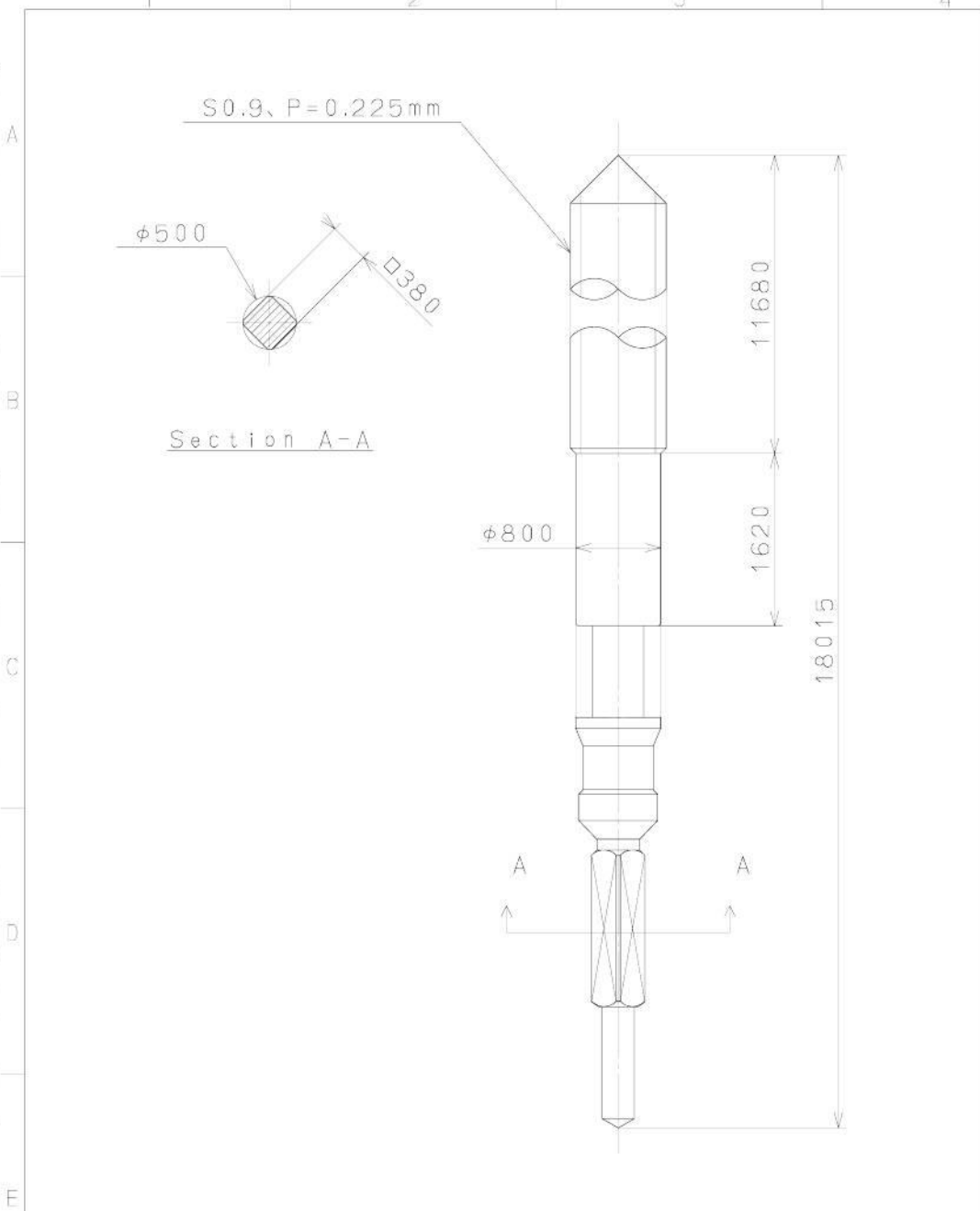

△			Quantity		Cal. NO.:
△			Unit	1/1000 <sub>mm</sub>	
△			Scale	20/1	Parts No.:
△			Date		065-505
△			Drawn		
Mark	Date	Description	Appr.	Checked	Name:
		Alterations		Approved	T. Hirata
Material					SETTING STEM
Heat Treatment					Drawing No.: 5050S000
Hardness			General Tolerances	<b>MIYOTA</b>	
Plating			Dimensions		
			Angles		
				CITIZEN WATCH CO., LTD., TOKYO, JAPAN	



# MIYOTA

---

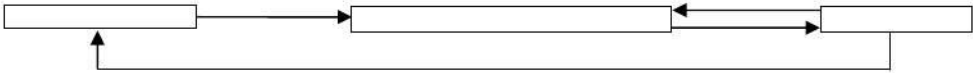
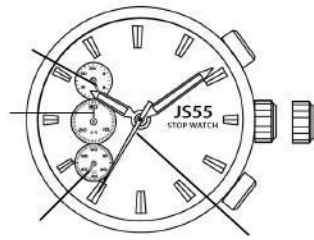

# MIYOTA

---

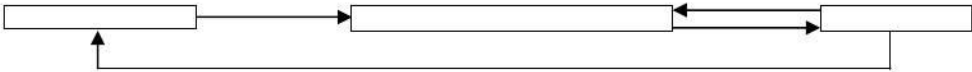
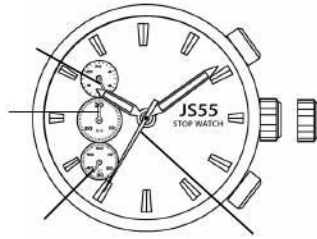
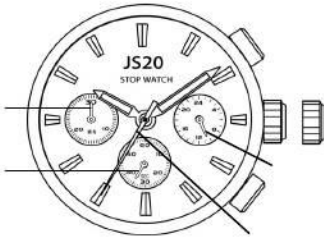

# MIYOTA

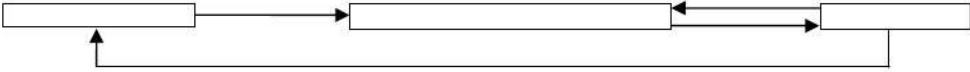
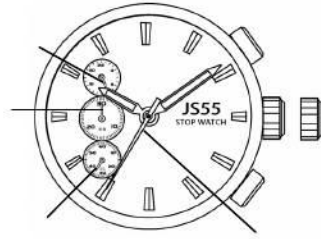

# MIYOTA

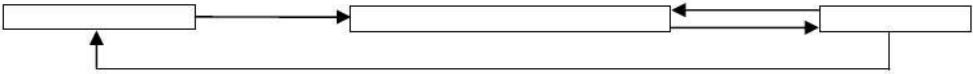
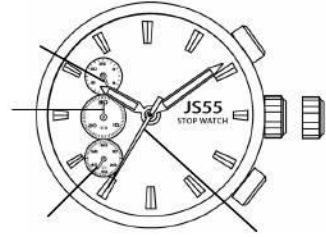

# MIYOTA

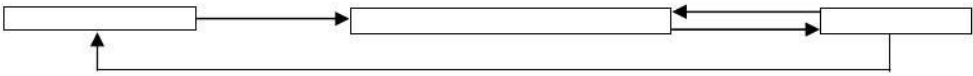
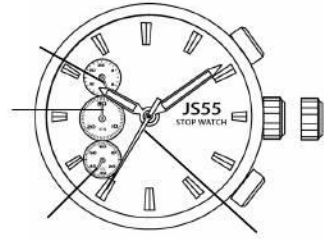
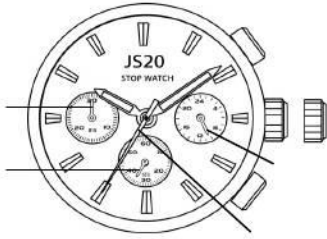

# MIYOTA

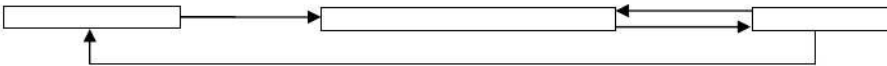
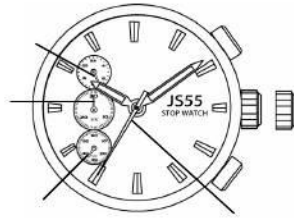
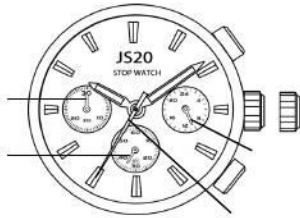

# MIYOTA

---

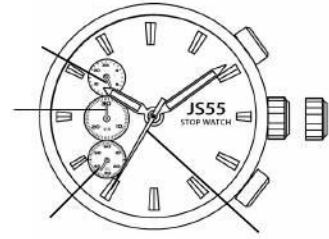

# MIYOTA

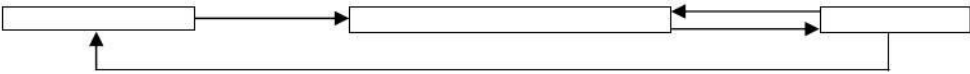
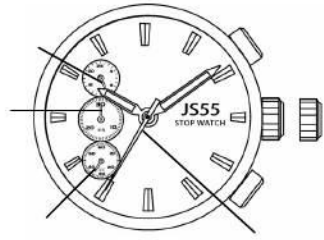
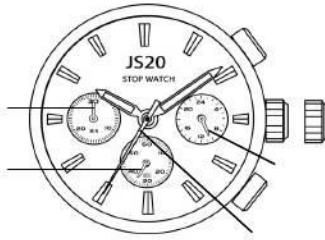

# MIYOTA

