

Contents

Precautions

Operating Precautions

User Maintenance

Battery

Before Getting Started...

General Guide

Indicators

Navigating Between Modes

Selecting a Timekeeping Mode Digital Display Format

Charging

Viewing the Face in the Dark

Time Adjustment

Adjusting the Current Time Setting

World Time

Checking World Time

Setting the World Time City

Alarm and Hourly Time Signal

Configuring Alarm Settings

Configuring the Hourly Time Signal Setting

Turning Off an Alarm or the Hourly Time Signal

Using the Dive Function

Measuring Elapsed Dive Time

Measuring Surface Interval Time

Exiting the Dive Mode

Viewing Dive Log Data

Deleting Dive Log Data

Tide Level and Moon Age

Checking the Current Tide Level and Moon Phase

Checking the Tide Level and Moon Age for a Specific Date and Time

Adjusting High Tide Times

Stopwatch

Measuring Elapsed Time

Measuring a Split Time

Timing the First and Second Place Finishers

Timer

Setting the Time

Using the Timer

Other Settings

Enabling the Button Operation Tone

Configuring Power Saving Function Settings

Other Information

City Table

Specifications

Troubleshooting

Precautions

Operating Precautions

● Water Resistance

- A diver's watch is designed to withstand pressure up to 200 meters. Do not wear this watch at depths greater than the depth marked on it. It can be worn while skin diving, scuba diving, etc. Do not use a diver's watch for deep diving (diving with a gas mixture) or at a depth greater than that indicated.
- Do not operate the crown while the watch is submerged.
- After submersion in seawater, use plain water to rinse all salt and dirt from your watch.
- To maintain water resistance, be sure to have the gaskets of your watch replaced regularly (once every two years).
- A trained technician will inspect your watch for proper water resistance whenever you have its battery replaced. Battery replacement requires the use of special tools. Always request battery replacement from your original retailer or from an authorized CASIO service center.
- Your diver's watch has been tested in accordance with International Organization for Standardization regulations.

● Precautions before Diving

- Check to make sure that all watch functions are working properly.
- Check to make sure the battery is charged sufficiently.
 - Before using the watch for diving, charge its battery up to Level 2.
- Do not over-use display illumination while diving. Doing so can cause your watch to disable illumination and alarms in order to conserve battery power.
- Check to make sure that the current time setting is correct.
- Check the watch glass for scratching, cracking, fogging, and other abnormalities.
- Check the case and band for damage and other abnormalities. Also, ensure that the band is securely tightened.

● Precautions while Diving

- Take care so your watch does not come into contact with rocks and other hard items.

● Band

- Tightening the band too tightly can cause you to sweat and make it difficult for air to pass under the band, which can lead to skin irritation. Do not fasten the band too tightly. There should be enough room between the band and your wrist so you can insert your finger.
- Deterioration, rust, and other conditions can cause the band to break or come off of your watch, which in turn can cause band pins to fly out of position or to fall out. This creates the risk of your watch falling from your wrist and becoming lost, and also creates the risk of personal injury. Always take good care of your band and keep it clean.
- Immediately stop using a band if you even notice any of the following: loss of band flexibility, band cracks, band discoloration, band looseness, band connecting pin flying or falling out, or any other abnormality. Take your watch to your original retailer or to a CASIO service center for inspection and repair (for which you will be charged) or to have the band replaced (for which you will be charged).

● Temperature

- Never leave your watch on the dashboard of a car, near a heater, or in any other location that is subject to very high temperatures. Do not leave your watch where it will be exposed to very low temperatures. Temperature extremes can cause your watch to lose or gain time, to stop, or otherwise malfunction.
- Leaving your watch in an area hotter than +60 °C (140 °F) for long periods can lead to problems with its LCD. The LCD may become difficult to read at temperatures lower than 0 °C (32 °F) and greater than +40 °C (104 °F).

● Impact

- Your watch is designed to withstand impact incurred during normal daily use and during light activity such as playing catch, tennis, etc. Dropping your watch or otherwise subjecting it to strong impact, however, can lead to malfunction. Note that watches with shock-resistant designs (G-SHOCK, BABY-G, G-MS) can be worn while operating a chain saw or engaging in other activities that generate strong vibration, or while engaging in strenuous sports activities (motocross, etc.)

● Magnetism

- Though a digital watch normally is not affected by magnetism, very strong magnetism (from medical equipment, etc.) should be avoided because it can cause malfunction and damage to electronic components.

● Electrostatic Charge

- Exposure to very strong electrostatic charge can cause your watch to display the wrong time. Very strong electrostatic charge even can damage electronic components.
- Electrostatic charge can cause the display to go blank momentarily or cause a rainbow effect on the display.

● Chemicals

- Do not allow your watch to come into contact with thinner, gasoline, solvents, oils, or fats, or with any cleaners, adhesives, paints, medicines, or cosmetics that contain such ingredients. Doing so can cause discoloration of or damage to the resin case, resin band, leather, and other parts.

● Storage

- If you do not plan to use your watch for a long time, thoroughly wipe it free of all dirt, sweat, and moisture, and store it in a cool, dry place.

● Resin Components

- Allowing your watch to remain in contact with other items or storing it together with other items for long periods while it is wet can cause color on resin components to transfer to the other items, or the color of the other items to transfer to the resin components of your watch. Be sure to dry off your watch thoroughly before storing it and make sure it is not in contact with other items.
- Leaving your watch where it is exposed to direct sunlight (ultraviolet rays) for long periods or failure to clean dirt from your watch for long periods can cause it to become discolored.
- Friction caused by certain conditions (strong external force, sustained rubbing, impact, etc.) can cause discoloration of painted components.
- If there are printed figures on the band, strong rubbing of the printed area can cause discoloration.
- Leaving your watch wet for long periods can cause fluorescent color to fade. Wipe the watch dry as soon as possible after it becomes wet.
- Semi-transparent resin parts can become discolored due to sweat and dirt, and if exposed to high temperatures and humidity for long periods.
- Daily use and long-term storage of your watch can lead to deterioration, breaking, or bending of resin components. The extent of such damage depends on usage conditions and storage conditions.

● Leather Band

- Allowing your watch to remain in contact with other items or storing it together with other items for long periods while it is wet can cause the color of the leather band to transfer to the other items or the color of the other items to transfer to the leather band. Be sure to dry off your watch thoroughly with a soft cloth before storing it and make sure it is not in contact with other items.
- Leaving a leather band where it is exposed to direct sunlight (ultraviolet rays) for long periods or failure to clean dirt from a leather band for long periods can cause it to become discolored.

CAUTION:

Exposing a leather band to rubbing or dirt can cause color transfer and discoloration.

● Metal Components

- Failure to clean dirt from metal components can lead to formation of rust, even if components are stainless steel or plated. If metal components exposed to sweat or water, wipe thoroughly with a soft, absorbent cloth and then place the watch in a well-ventilated location to dry.
- Use a soft toothbrush or similar tool to scrub the metal with a weak solution of water and a mild neutral detergent, or with soapy water. Next, rinse with water to remove all remaining detergent and then wipe dry with a soft absorbent cloth. When washing metal components, wrap the watch case with kitchen plastic wrap so it does not come into contact with the detergent or soap.

● Bacteria and Odor Resistant Band

- The bacteria and odor resistant band protects against odor generated by the formation of bacteria from sweat, which ensures comfort and hygiene. In order to ensure maximum bacteria and odor resistance, keep the band clean. Use an absorbent soft cloth to thoroughly wipe the band clean of dirt, sweat, and moisture. A bacteria and odor resistant band suppresses the formation of organisms and bacteria. It does not protect against rash due to allergic reaction, etc.

● Liquid Crystal Display

- Display figures may be difficult to read when viewed from an angle.

● Watch with Data Memory

- Allowing the battery to go dead, replacing the battery, or having your watch repaired can cause all data in watch memory to be lost. Note that CASIO Computer Co., Ltd. assumes no responsibility for any damages or losses caused by data lost due to malfunction or repair of your watch, replacement of the battery, etc. Be sure to keep separate written copies of all important data.

Note that CASIO Computer Co., Ltd. assumes no responsibility for any damage or loss suffered by you or any third party arising through the use of your watch or its malfunction.

User Maintenance

● Caring for Your Watch

Remember that you wear your watch next to your skin, just like a piece of clothing. To ensure your watch performs at the level for which it is designed, keep it clean by frequently wiping with a soft cloth to keep your watch and band free of dirt, sweat, water and other foreign matter.

- Whenever your watch is exposed to sea water or mud, rinse it off with clean fresh water.
- For a metal band or a resin band with metal parts, use a soft toothbrush or similar tool to scrub the band with a weak solution of water and a mild neutral detergent, or with soapy water. Next, rinse with water to remove all remaining detergent and then wipe dry with a soft absorbent cloth. When washing the band, wrap the watch case with kitchen plastic wrap so it does not come into contact with the detergent or soap.
- For a resin band, wash with water and then wipe dry with a soft cloth. Note that sometimes a smudge like pattern may appear on the surface of a resin band. This will not have any effect on your skin or clothing. Wipe with a cloth to remove the smudge pattern.
- Clean water and sweat from a leather band by wiping with a soft cloth.
- Not operating a watch crown, buttons, or rotary bezel could lead to later problems with their operation. Periodically rotate the crown and rotary bezel, and press buttons to maintain proper operation.

● Dangers of Poor Watch Care

Rust

- Though the metal steel used for your watch is highly rust-resistant, rust can form if your watch is not cleaned after it becomes dirty.
 - Dirt on your watch can make it impossible for oxygen to come into contact with the metal, which can lead to breakdown of the oxidization layer on the metal surface and the formation of rust.
- Rust can cause sharp areas on metal components and can cause band pins to fly out of position or to fall out. If you ever notice any abnormality immediately stop using your watch and take it to your original retailer or to an authorized CASIO service center.
- Even if the surface of the metal appears clean, sweat and rust in crevasses can soil the sleeves of clothing, cause skin irritation, and even interfere with watch performance.

Premature Wear

- Leaving sweat or water on a resin band or bezel, or storing your watch an area subject to high moisture can lead to premature wear, cuts, and breaks.

Skin Irritation

- Individuals with sensitive skin or in poor physical condition may experience skin irritation when wearing a watch. Such individuals should keep their leather band or resin band particularly clean. Should you ever experience a rash or other skin irritation, immediately remove your watch and contact a skin care professional.

Battery

- The special rechargeable battery used by your watch is not intended to be removed or replaced by you. Use of a rechargeable battery other than the special one specified for your watch can damage your watch.
- The rechargeable (secondary) battery is charged when the solar panel is exposed to light, so it does not require regular replacement as the primary battery requires. Note, however, that long use or operating conditions can cause the capacity or charging efficiency of the rechargeable battery to deteriorate. If you feel that the amount of operation provided by charging is too short, contact your original retailer or CASIO service center.

Before Getting Started...

This section provides an overview of the watch and introduces convenient ways it can be used.

Important!

- This watch is not a special-purpose measuring instrument. Measurement function readings are intended for general reference only.
- It can be used while skin diving, scuba diving, etc.
[Using the Dive Function](#)

● Watch Features

• Solar Charging

Sunlight and artificial light generate electricity for watch operation as it charges.

• Dive Function

You can use this function to measure your dive times and surface intervals. You can also view dive logs, and record dates and times. You can delete data as required.

• Tide Level and Moon Age

You can look up the tide level and Moon age on a date and time you specify.

• World Time

World Time displays the current time in any of 31 time zones around the globe.

• Alarm

An alarm sounds whenever a time specified by you is reached.

• Stopwatch

You can use the stopwatch to measure up to 24 hours of elapsed time in units of 1/100 of a second.

• Timer

Countdown from a start time specified by you. An alarm sounds when the countdown reaches zero.

Note

- The illustrations included in this operation guide have been created to facilitate explanation. An illustration may differ somewhat from the item it represents.

General Guide

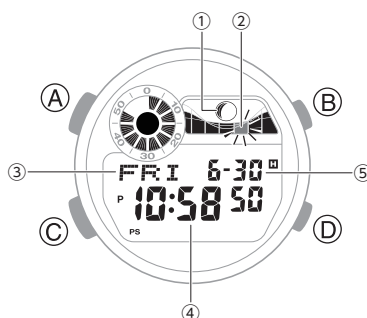

- ① Moon Graph
- ② Tide Graph
- ③ Day of the week
- ④ Hour, minute, second
- ⑤ Month, day

A button

Holding down this button for at least two seconds in any mode displays the setting screen.

B button

Press to turn on illumination.

C button

Each press cycles between watch modes.

D button

Pressing this button while any setting screen is displayed will change the setting.

Indicators

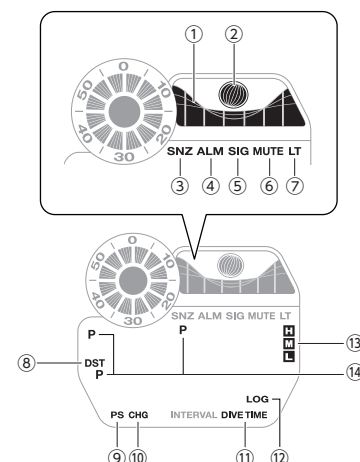

- ① Shows a Tide Graph (tide level) at the current time.
- ② Shows the Moon Graph (Moon phase) of the current date.
- ③ Displayed while the snooze alarm is turned on.
- ④ Displayed while an alarm is turned on.
- ⑤ Displayed while the hourly time signal is enabled.
- ⑥ Displayed while the button operation tone is disabled.
- ⑦ Displayed while Auto Light is enabled.
- ⑧ Displayed while the watch is indicating summer time.
- ⑨ Displayed while Power Saving is enabled.
- ⑩ Flashes when battery power is low.
- ⑪ Displayed while in the Dive Mode.
- ⑫ Displayed while in the Log Data Recall Mode.
- ⑬ Shows the current charge level.
- ⑭ Displayed during p.m. times while 12-hour timekeeping is being used.

Navigating Between Modes

Each press of (C) cycles between watch modes.

- In any mode*, hold down (C) for at least one second to enter the Dive Mode.

* Except the Dive Mode

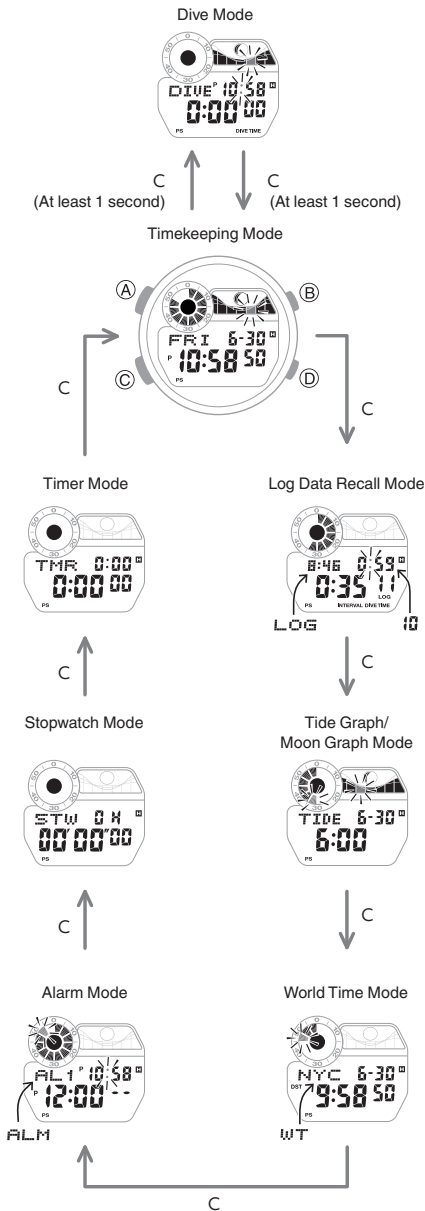

Selecting a Timekeeping Mode Digital Display Format

Each press of (A) in the Timekeeping Mode toggles between the display information as shown below.

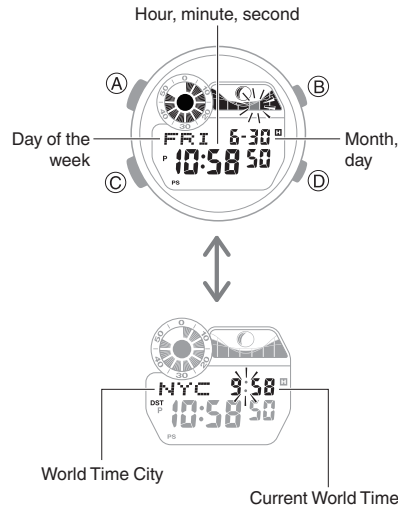

Charging

This watch runs on power supplied from a rechargeable (secondary) battery that is charged by a solar panel. The solar panel is integrated into the face of the watch, and power is generated whenever the face is exposed to light.

Charging the Watch

When you are not wearing the watch, put it in a location where it is exposed to bright light.

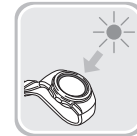

While you are wearing the watch, make sure that its face (solar panel) is not blocked from light by the sleeve of your clothing. Power generation efficiency is reduced even when the face of the watch is blocked only partially.

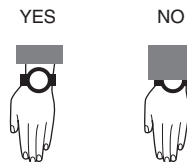

Important!

- Some light sources and environments can cause the watch to become extremely hot during charging, which creates the risk of burn injury and damage to internal watch components. Avoid charging the watch under conditions like the ones described below, where the temperatures may exceed 60 °C (140 °F).
 - On the dashboard of a vehicle parked in the sun
 - Near incandescent lamps, camera lights, halogen lamps, or other sources of heat
 - In locations exposed to direct sunlight for long periods and other hot locations
- The display panel may become black (or white, depending on the LCD type) under very high temperatures. This is temporary, and the display will return to normal at lower temperatures.

● Checking the Charge Level

A display indicator shows the watch's current charge level.

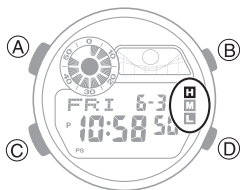

Charge Level 1: Good

All functions enabled.



Charge Level 2: Good

All functions enabled.



Charge Level 3: Low

[L] flashes on the display, and the functions below become disabled.

- Dive Mode
- Face illumination
- Sounds (alarm, etc.)



Charge Level 4: Low

When the battery charge drops lower than Level 3, [CHG] starts to flash on the display and all functions become disabled.



Charge Level 5: Dead

The digital display will go blank if the battery goes dead. Memory data is lost, and watch settings are returned to their initial factory defaults.

Important!

- Should the battery go low or go dead, expose the face (solar panel) to light as soon as possible.

Note

- When [H], [M], and [L] are all flashing on the display, it means that all functions are disabled due to momentary battery power consumption.

🔍 [H], [M], and [L] are flashing on the display.

● Charging Time Guidelines

The table below shows guidelines for approximate charging times.

Charging Times Required for 1 Day of Operation

Light Level (Lux)	Approximate Charging Time
50,000	4 minutes
10,000	24 minutes
5,000	48 minutes
500	8 hours

Charge Recovery Times

- Sunny day, outdoors (50,000 lux)

Dead battery → Medium charge	2 hours
Medium charge → High charge	26 hours
High charge → Full charge	7 hours

- Sunny day, near a window (10,000 lux)

Dead battery → Medium charge	9 hours
Medium charge → High charge	135 hours
High charge → Full charge	36 hours

- Overcast day, near a window (5,000 lux)

Dead battery → Medium charge	19 hours
Medium charge → High charge	275 hours
High charge → Full charge	73 hours

- Indoor fluorescent lighting (500 lux)

Dead battery → Medium charge	243 hours
Medium charge → High charge	-
High charge → Full charge	-

Note

- Actual charging time depends on the charging environment, watch settings, and other factors.

● Power Saving Function

Leaving the watch in a dark location for about one hour between the hours of 10 p.m. and 6 a.m. will cause the display to go blank, and the watch to enter Level 1 power saving. If the watch is left in this condition for six or seven days, the watch will enter Level 2 power saving.

Power Saving Level 1 :

Digital display goes blank to save power.

Power Saving Level 2 :

Digital display goes blank to save power. All functions are disabled.

Recovering from Power Saving Operation

Use one of the operations below to exit power saving.

- Press any button.
- Move the watch to a bright location.
- Trigger auto light by angling the watch towards your face.

Note

- The watch will not enter power saving in the cases below.
 - Dive Mode
 - While in the Stopwatch Mode
 - While in the Timer Mode
- You can enable or disable Power Saving.
 - 🔍 [Configuring Power Saving Function Settings](#)
- Note that the watch also may enter power saving if its face is blocked from light by your sleeve while you are wearing it.

Viewing the Face in the Dark

The watch has a light that illuminates the face for viewing in the dark.

● To illuminate the face manually

Press (B) to turn on illumination.

- Illumination will turn off automatically if an alarm starts to sound.



● To illuminate the face when Auto Light is enabled

If Auto Light is enabled, face illumination will turn on automatically whenever the watch is positioned at an angle of 40 degrees or more.

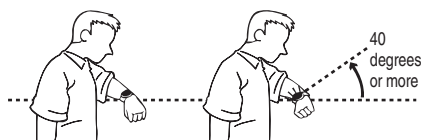

Important!

- Auto Light may not operate properly when the watch is at a horizontal angle of 15 degrees or greater from horizontal as shown in the illustration below.



- Electro-static charge or magnetism can interfere with proper auto light operation. If this happens, try lowering your arm and then angle it towards your face again.
- When moving the watch you may note a slight rattling sound. This is due to operation of the auto light switch, which determines the current orientation of the watch. It does not indicate malfunction.
- Frequent use of illumination will run down the battery.
- Certain positions during diving may interfere with Auto Light operation.

Note

- Auto Light is disabled when any one of the conditions below exists.
 - Alarm, timer alert, or other beeper sounding

● Configuring the Auto Light Setting

1. Enter the Timekeeping Mode.
 ◉ [Navigating Between Modes](#)
2. Hold down (B) for at least three seconds to toggle Auto Light between enabled and disabled.
 - [LT] is displayed while Auto Light is enabled.



Note

- Auto Light is disabled while [CHG] is shown on the display.

● Specifying the Illumination Duration

You can select either 1.5 seconds or three seconds as the illumination duration.

1. Enter the Timekeeping Mode.
 ◉ [Navigating Between Modes](#)
2. Hold down (A) for at least two seconds. Release the button when the city code starts to flash.

City code

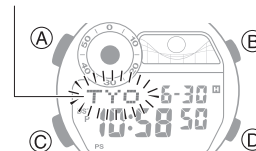

3. Press (C) 10 times.
 [LT] appears on the display with [1] or [3] flashing.
4. Press (D) to select an illumination duration.
 [LT1]: 1.5-second light
 [LT3]: 3-second light

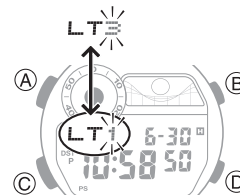

5. Press (A) to complete the setting operation.

Note

- While the setting is being configured, the watch will exit the setting operation automatically after about two or three minutes of non-operation.
- The illumination duration is fixed as three seconds in the Dive Mode.

Time Adjustment

Use the procedures in this section to adjust the date and time settings.



Adjusting the Current Time Setting

Use the procedures below to adjust the current date and time settings, and to select a Home City.

● Setting a Home City

Use the procedure in this section to select a city to use as your Home City. If you are in an area that observes summer time, you can also configure a summer time setting.

1. Enter the Timekeeping Mode.
[🔍 Navigating Between Modes](#)

2. Hold down (A) for at least two seconds. Release the button when the city code starts to flash.

City code



3. Use (B) and (D) to change the Home City setting.

- Holding down (B) or (D) scrolls through settings at high speed.
- For details refer to the information below.
[🔍 City Table](#)

4. Press (C).
5. Use (D) to change the summer time setting.
 - [OFF]
The watch always indicates standard time.
 - [ON]
The watch always indicates summer time.



6. Press (A) to complete the setting operation.

Note

- While the setting is being configured, the watch will exit the setting operation automatically after about two or three minutes of non-operation.

● Setting the Time/Date

Important!

- Configure the Home City setting before changing the current time and date settings.
[🔍 Setting a Home City](#)

1. Enter the Timekeeping Mode.
[🔍 Navigating Between Modes](#)
2. Hold down (A) for at least two seconds. Release the button when the city code starts to flash.

City code

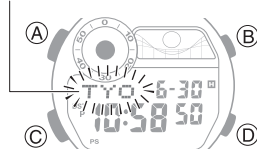

3. Use (C) to display the setting you want to change.
 - Each press of (C) cycles through settings in the sequence shown below.

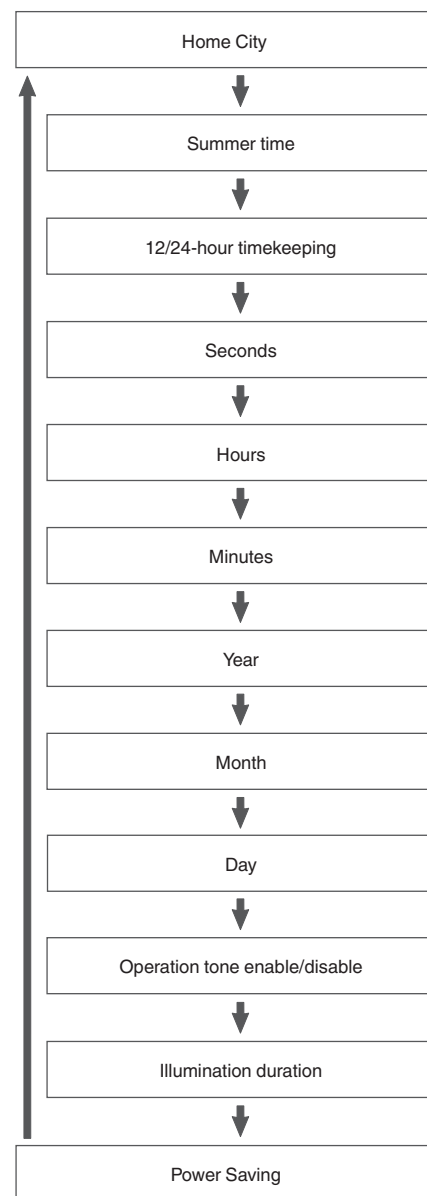

4. Configure the date and time settings.

- While the seconds are flashing, pressing (D) will reset them to 00. 1 is added to the minutes when the current seconds count is between 30 and 59 seconds.
- For all the other settings, use (B) and (D) to change the flashing setting. Holding down (B) or (D) scrolls through settings at high speed.

5. Repeat steps 3 and 4 to select time and date settings.

6. Press (A) to complete the setting operation.

Note

- While the setting is being configured, the watch will exit the setting operation automatically after about two or three minutes of non-operation.

● Switching between 12-hour and 24-hour Timekeeping

You can specify either 12-hour format or 24-hour format for the time display.

1. Enter the Timekeeping Mode.

🔗 [Navigating Between Modes](#)

2. Hold down (A) for at least two seconds. Release the button when the city code starts to flash.

City code

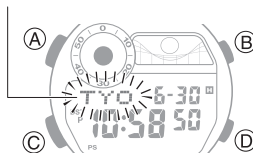

3. Press (C) twice.

This causes [12H] or [24H] to flash on the display.



4. Press (D) to select [12H] (12-hour timekeeping) or [24H] (24-hour timekeeping).

12-hour timekeeping

24-hour timekeeping

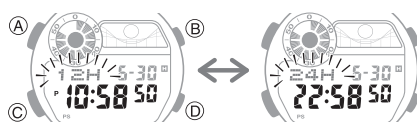

5. Press (A) to complete the setting operation.

Note

- While the setting is being configured, the watch will exit the setting operation automatically after about two or three minutes of non-operation.

World Time

World Time lets you look up the current time in any of 48 cities (31 time zones) around the globe.

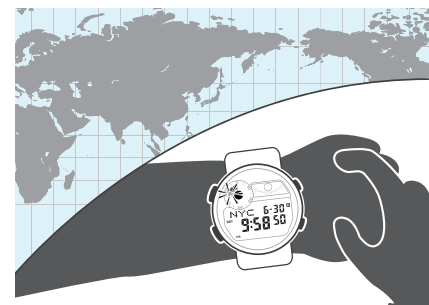

Checking World Time

1. Enter the World Time Mode.

🔗 [Navigating Between Modes](#)

Entering the World Time Mode displays the city code of the currently selected World Time city.

- Each press of (D) scrolls through city codes.
- To select UTC (Offset: 0) as the city code, press (B) and (D) at the same time.
- For information about city codes, see the information below.

🔗 [City Table](#)

City code

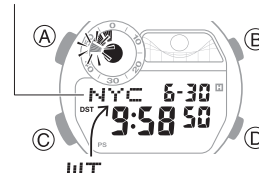

Setting the World Time City

Use the procedure in this section to select a World Time city. If you are in an area that observes summer time, you can also configure a summer time setting.

1. Enter the World Time Mode.

[Navigating Between Modes](#)

2. Press (D) to display the city code of the currently selected city.

- Holding down (D) scrolls through settings at high speed.
- To select UTC (Offset: 0) as the city code, press (B) and (D) at the same time.
- For information about city codes, see the information below.

[City Table](#)

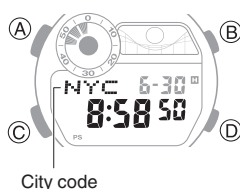

3. If you want to configure the summer time setting, hold down (A) for at least two seconds.

[DST] is displayed along with summer time.

- Each time you hold down (A) for at least two seconds, the setting toggles between standard time and summer time.



Note

- While the setting is being configured, the watch will exit the setting operation automatically after about two or three minutes of non-operation.
- The summer time setting you configure is applied to the currently selected city only. It does not affect other cities.

Alarm and Hourly Time Signal

The watch will beep when the alarm time is reached. You can configure up to four standard daily alarms, and one daily alarm with snooze. The hourly time signal causes the watch to beep every hour on the hour.

- Snooze causes the alarm to sound up to seven times, at five-minute intervals.
- The alarm sound is muted in the cases described below.
 - When battery power is low
 - When watch is at Level 2 power saving

[Power Saving Function](#)



Configuring Alarm Settings

1. Enter the Alarm Mode.

[Navigating Between Modes](#)

2. Press (D) to scroll through alarms ([1] to [4], [SNZ]) until the one you want to configure is displayed.

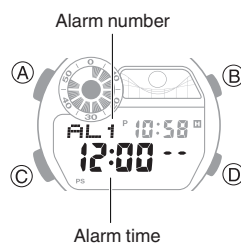

3. Hold down (A) for at least two seconds.

This causes the hours digits to flash.

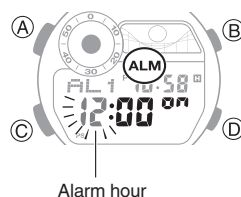

4. Use (B) and (D) to change the hour setting.

- Holding down (B) or (D) scrolls through settings at high speed.
- If you are using 12-hour timekeeping, [P] indicates p.m.



5. Press (C).

This causes the minutes digits to flash.

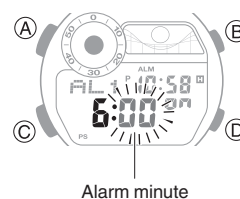

6. Use (B) and (D) to set the minute setting.

7. Press (A) to complete the setting operation.

Note

- While the setting is being configured, the watch will exit the setting operation automatically after about two or three minutes of non-operation.

● Testing the alarm

In the Alarm Mode, hold down (D) to sound the alarm.

● To stop the alarm

To stop the alarm after it starts to sound when an alarm time is reached, press any button.

Snooze causes the alarm to sound up to seven times, at five-minute intervals. To cancel a snooze alarm, turn [SNZ] off.

[Turning Off an Alarm or the Hourly Time Signal](#)

Note

- A beeper will sound for 10 seconds to let you know when the alarm time is reached.
- The watch will automatically return to the Timekeeping Mode from the Alarm Mode after two or three minutes of non-operation.

Configuring the Hourly Time Signal Setting

1. Enter the Alarm Mode.
[Navigating Between Modes](#)
2. Use (D) to display the hourly time signal screen ([SIG]).



3. Press (A) to toggle the hourly time signal between enabled and disabled.
 - [SIG] (hourly time signal) is shown on the display while the hourly time signal is enabled.

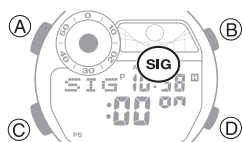

Turning Off an Alarm or the Hourly Time Signal

To stop an alarm or the hourly time signal from sounding, perform the steps below to turn it off.

- To have an alarm or hourly time signal sound again, turn it back on.

Note

- Indicators are displayed while any of the alarms or the hourly time signal is turned on.
- The applicable indicators are not displayed while all of the alarms are turned off and/or the hourly time signal is turned off.

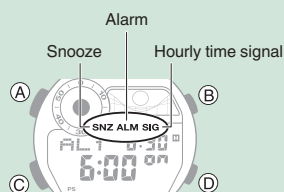

1. Enter the Alarm Mode.
[Navigating Between Modes](#)
2. Press (D) to scroll through alarms ([1] to [4], [SNZ]) until the one you want to configure is displayed.

Alarm number or hourly time signal



3. Press (A) to turn off the displayed alarm or the hourly time signal.
 - Each press of (A) toggles between on and off.
 - Turning off all alarms will cause [ALM] (alarm) to disappear from the display, while disabling the hourly time signal causes [SIG] (hourly time signal) to disappear from the display.



Note

- If [ALM] (alarm) is still displayed, it means that another alarm is still turned on. To turn off all of the alarms, repeat steps 2 and 3 until the [ALM] (alarm) indicator is no longer displayed.

Using the Dive Function

You can use the procedures in this section to measure dive times and surface intervals. The watch also records dive log data automatically. There is memory for up to 10 dive log data records. Recording dive log data when there are already 10 log data records in memory causes the oldest log record to be deleted automatically to make room for the new one.

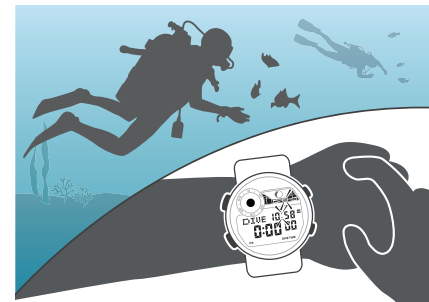

- You can use diving log data to view the items below.
 - Dive start date and time
 - Dive time
 - Surface interval

You can use the Log Data Recall Mode to view recorded dive log data.

[Viewing Dive Log Data](#)

Important!

- If the battery is low or dead, charge it before using the watch for diving.
- Before starting a dive (while still on a boat or the water's surface), enter the Dive Mode.

Measuring Elapsed Dive Time

Dive time is measured in units of one second up to 23 hours, 59 minutes, 59 seconds (24 hours).

1. Enter the Dive Mode.
[🔍 Navigating Between Modes](#)
2. Press (D).
 This starts dive time measurement.

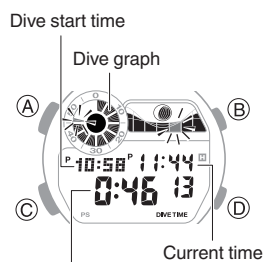

Dive time (hours, minutes, seconds)

3. Hold down (D) for at least one second to stop dive time measurement.
 This starts surface interval measurement.
4. Press (A) to reset the measurement time to all zeros.
 - Resetting the measurement causes log data to be recorded.

Note

- The surface interval is not displayed during measurement. Only the latest log data record is displayed in the Log Data Recall Mode.
[🔍 Viewing Dive Log Data](#)
- After you finish Dive Mode measurement, holding down (C) for at least one second to enter the Timekeeping Mode also reset measurement up to that point.
- Even if you return to the Timekeeping Mode while a Dive Mode dive time measurement operation is in progress, the watch continues the measurement operation internally.
- If 11 or 12 hours elapse after the watch enters the Dive Mode, it automatically returns to the Timekeeping Mode.

Measuring Surface Interval Time

This function measures the time since your last dive as surface interval time, which can be used in preparation for repetitive diving.

The surface interval time can be measured up to 48 hours in one-minute increments.

1. Enter the Dive Mode.
[🔍 Navigating Between Modes](#)
2. Use the operations below to perform a timer operation.

- Ⓧ Dive 1 start
- ↓
- Ⓧ Surface Interval 1 start
(Hold down at least one second.)
- ↓
- Ⓧ Dive 2 start
- ↓
- Ⓧ Surface Interval 2 start
(Hold down at least one second.)
- ⋮

3. To reset the ongoing surface interval measurement operation, press (A).
 - Resetting the measurement causes log data to be recorded.

Note

- The surface interval is not displayed during measurement. Only the latest log data record is displayed in the Log Data Recall Mode.
[🔍 Viewing Dive Log Data](#)
- Even if you return to the Timekeeping Mode while a Dive Mode dive time measurement operation is in progress, the watch continues the measurement operation internally.
- If 11 or 12 hours elapse after the watch enters the Dive Mode, it automatically returns to the Timekeeping Mode.

Exiting the Dive Mode

After you finish performing dive time measurement in the Dive Mode, holding down (C) for at least one second enters the Timekeeping Mode.

- Even if you return to the Timekeeping Mode while a dive time measurement operation is in progress, the watch continues the measurement operation internally.

Viewing Dive Log Data

1. Enter the Log Data Recall Mode.
[🔍 Navigating Between Modes](#)

This displays the latest log data.

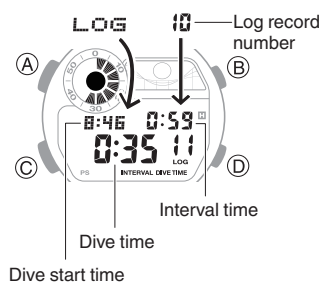

- The interval time is shown on the latest log data record only.
- The message [- : -] appears when there is no log data.

2. Press (D).

Each press of (D) scrolls back from the newest log data record.

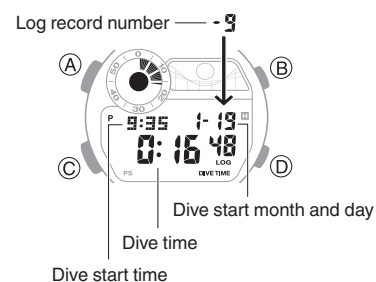

- Older data records have lower record numbers.

Note

- There is memory for up to 10 dive log data records. Recording dive log data when there are already 10 log data records in memory causes the oldest log record to be deleted automatically to make room for the new one.
- The watch automatically returns to the Timekeeping Mode from the Log Data Recall Mode after one or two minutes of non-operation.

Deleting Dive Log Data

This deletes all log data records. Note that log data records cannot be deleted individually.

1. Enter the Log Data Recall Mode.
[Navigating Between Modes](#)
2. Hold down (A) for at least two seconds.
 This deletes the diving log data.

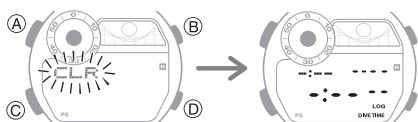

Tide Level and Moon Age

You can use the procedures in this section to check the tide level and Moon age in your currently selected Home Time city.



Important!

- Displayed information is intended for reference only. Do not use it for maritime navigation, etc.
- Before looking up a tide level or Moon age, configure your Home City settings.
[Setting a Home City](#)

Checking the Current Tide Level and Moon Phase

The current time's tide graph and the current date's Moon phase (Moon Graph) are displayed in the modes below.

- Timekeeping Mode
- Tide Graph/Moon Graph Mode
- Dive Mode

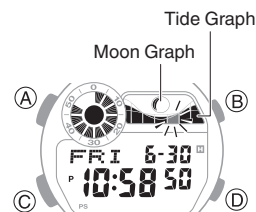

Interpreting Tide Graph Information

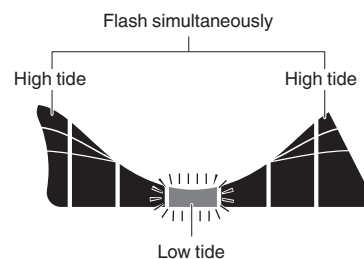

Tide Cycle (Three Patterns)

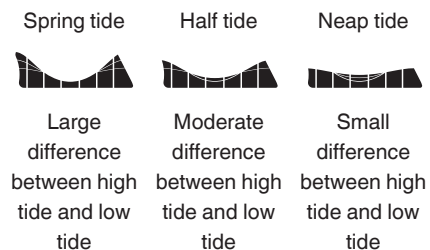

Interpreting the Moon Graph

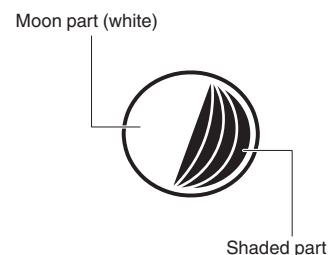

● Interpreting the Moon Graph and Moon Age Indicator

Moon phase	Moon age	This indicator:
New Moon	0.0 to 0.9	
	28.7 to 29.8	
	1.0 to 2.7	
First Quarter	2.8 to 4.6	
	4.7 to 6.4	
	6.5 to 8.3	
Full Moon	8.4 to 10.1	
	10.2 to 12.0	
	12.1 to 13.8	
Last Quarter	13.9 to 15.7	
	15.8 to 17.5	
	17.6 to 19.4	
New Moon	19.5 to 21.2	
	21.3 to 23.1	
	23.2 to 24.9	
New Moon	25.0 to 26.8	
	26.9 to 28.6	

- The Moon phase shown by the Moon graph is the approximate shape of the Moon at noon of the displayed date. It is meant only to indicate whether the left or right side of the Moon is shaded. Its shape is different from the actual phase of the Moon.
- The Moon phases shown in the above table are for when the Moon is viewed towards the south with respect to the northern hemisphere. In the Southern Hemisphere or near the equator, the light and dark portions of the Moon are opposite those shown by the watch's indicator.

Checking the Tide Level and Moon Age for a Specific Date and Time

You can use the procedures in this section to look up the tide level (Tide Graph) and Moon age for a date or time you specify.

1. Enter the Tide Graph/Moon Graph Mode. [Navigating Between Modes](#)

Entering the Tide Graph/Moon Graph Mode displays a Tide Search or Moon Search screen.

2. Press (A) to toggle between Tide Search and Moon Search.

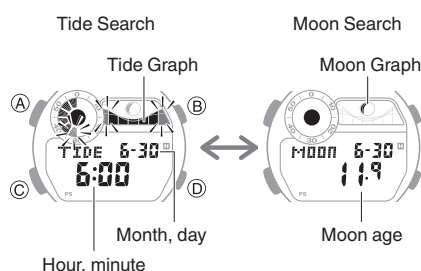

- The initial setting of Tide Search is 6:00 a.m.

● To check the Tide Graph at the top of each hour of the current day

1. Enter the Tide Graph/Moon Graph Mode. [Navigating Between Modes](#)

2. Press (A) to display the Tide Search screen.

3. Use (D) to select the time whose Tide Graph you want to view.

- Each press of (D) advances the time by one hour.
- Holding down (D) scrolls through settings at high speed.

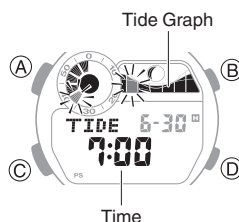

● To scroll the day and check information

1. Enter the Tide Graph/Moon Graph Mode. [Navigating Between Modes](#)

2. Press (A) to display the Moon Search screen.

3. Use (D) to select the day whose Moon age you want to view.

- Each press of (D) advances by one day.
- Holding down (D) scrolls through settings at high speed.

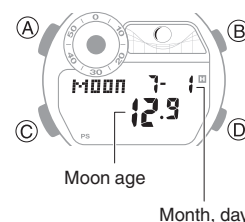

4. Press (A) to display the Tide Search screen.

5. Use (D) to select the time whose Tide Graph you want to view.

- Each press of (D) advances the time by one hour.
- Holding down (D) scrolls through settings at high speed.

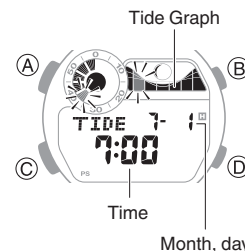

Note

- The watch automatically returns to the Timekeeping Mode from the Tide Graph/Moon Graph Mode after two or three minutes of non-operation.

Adjusting High Tide Times

You can improve the accuracy of the displayed high tide by adjusting the high tide time in accordance with information available on the internet or in a newspaper.

1. Enter the Tide Graph/Moon Graph Mode.

[Navigating Between Modes](#)

2. Hold down (A) for at least two seconds. Release the button when the tide graph high tide time hour setting starts to flash.

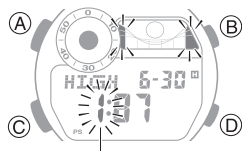

Tide graph high tide time hour

3. Use (C) to select the setting item you want to change.

- Each press of (C) cycles through setting items in the sequence shown below.

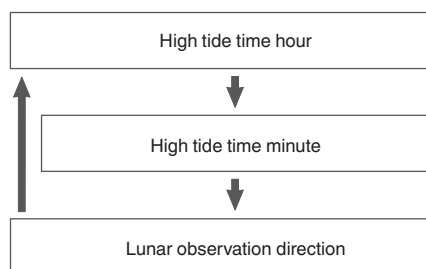

4. Configure the settings.

• Specifying the high tide time

Use (B) and (D) to change the value.

- Holding down (B) or (D) scrolls through settings at high speed.

Note

- To return the high tide time setting to its initial factory default setting, press (B) and (D) at the same time.
- For a location where there are two high tides per day, set the time of the first high tide. The watch will automatically calculate the time of the second high tide.
- The high tide time you set here does not change even if you turn on daylight saving time in the Timekeeping Mode.

• Specifying the lunar observation direction

Use the operation below to select “Northern Hemisphere Moon phase (Moon visible towards the south)” or “Southern Hemisphere Moon phase (Moon visible towards the north)”.

Use (D) and [▶] to change the direction.

[N ▶ S]: Moon visible towards the south

[N ◀ S]: Moon visible towards the north

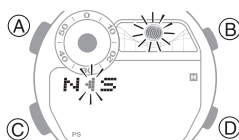

5. Repeat steps 3 and 4 to perform high tide time calibration.

6. Press (A) to complete the setting operation.

Note

- While the setting is being configured, the watch will exit the setting operation automatically after about two or three minutes of non-operation.

Stopwatch

The stopwatch measures elapsed time in units of 1/100 second up to 23 hours, 59 minutes, 59.99 seconds (24 hours).

When this maximum limit is exceeded, elapsed time measurement returns to 0 and timing continues from there.



Measuring Elapsed Time

1. Enter the Stopwatch Mode.

[Navigating Between Modes](#)

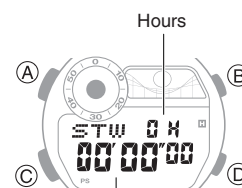

Minutes, seconds, 1/100 seconds

2. Use the operations below to measure elapsed time.

- Ⓧ Start
- ↓
- Ⓧ Stop
- ↓
- Ⓧ Resume
- ↓
- Ⓧ Stop

3. Press (A) to reset the measurement time to all zeros.

Measuring a Split Time

1. Enter the Stopwatch Mode.
[Navigating Between Modes](#)

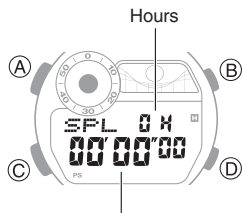

Minutes, seconds, 1/100 seconds

2. Use the operations below to measure elapsed time.
 - Pressing (A) displays the elapsed time from the start of a race up to the point when you pressed the button (split time).

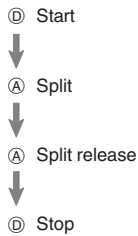

3. Press (A) to reset the measurement time to all zeros.

Timing the First and Second Place Finishers

1. Enter the Stopwatch Mode.
[Navigating Between Modes](#)

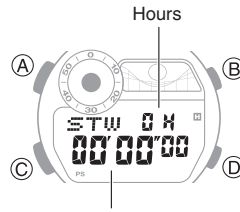

Minutes, seconds, 1/100 seconds

2. Use the operations below to measure elapsed time.

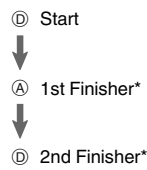

* This displays the time of the first finisher.

3. Press (A) to display the time of the second finisher.
4. Press (A) to reset the measurement time to all zeros.

Timer

The timer counts down from a start time specified by you. A beeper sounds when the end of the countdown is reached.

- The beeper is muted when battery power is low.



Setting the Time

The countdown start time can be set in 1-minute units up to 24 hours.

- If a timer countdown operation is in progress, reset the timer to its current start time before performing this operation.

[Using the Timer](#)

1. Enter the Timer Mode.
 [Navigating Between Modes](#)
2. Hold down (A) for at least two seconds.
This causes the hours digits to flash.

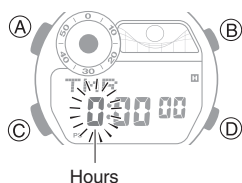

3. Use (B) and (D) to change the timer hours setting.
 - Holding down (B) or (D) scrolls through settings at high speed.
4. Press (C).
This causes the minutes digits to flash.

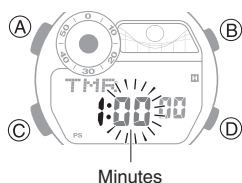

5. Use (B) and (D) to change the timer minutes setting.
6. Press (A) to complete the setting operation.

Note

- While the setting is being configured, the watch will exit the setting operation automatically after about two or three minutes of non-operation.
- Setting a start time of 0:00 performs a countdown of 24 hours.

Using the Timer

The timer counts down time in 1-second units.

1. Enter the Timer Mode.
 [Navigating Between Modes](#)

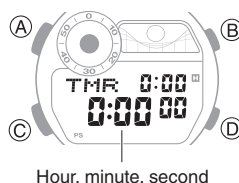

2. Use the operations below to perform a timer operation.

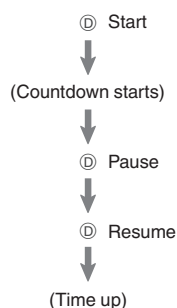

3. Press any button to stop the tone.
 - A beeper will sound for 10 seconds to let you know when the end of a countdown is reached.
 - You can reset a paused countdown to its start time, by pressing (A).

Other Settings

This section explains other watch settings you can configure.

Enabling the Button Operation Tone

Use the procedure below to enable or disable the tone that sounds when you press a button.

1. Enter the Timekeeping Mode.
 [Navigating Between Modes](#)
2. Hold down (A) for at least two seconds.
Release the button when the city code starts to flash.

City code

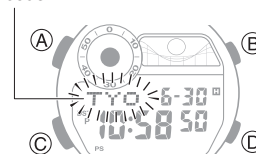

3. Press (C) nine times.
This causes [KEY↵] or [MUTE] to flash on the display.

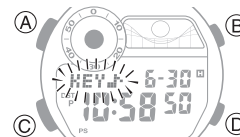

4. Press (D) to select [KEY↵] or [MUTE].
[KEY↵]: Operation tone enabled.
[MUTE]: Operation tone disabled.

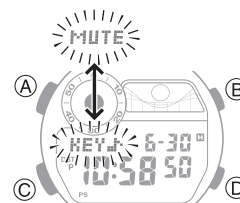

5. Press (A) to complete the setting operation.
 - [MUTE] is displayed while the operation tone is muted.

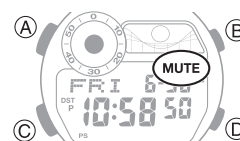

Note

- While the setting is being configured, the watch will exit the setting operation automatically after about two or three minutes of non-operation.
- Note that alarm and timer tones will still sound even while the operation tone is muted.

Configuring Power Saving Function Settings

1. Enter the Timekeeping Mode.
[🔍 Navigating Between Modes](#)
2. Hold down (A) for at least two seconds. Release the button when the city code starts to flash.

City code

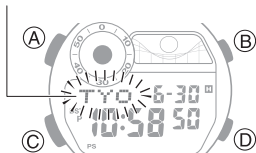

3. Press (C) 11 times.
This displays [PS].

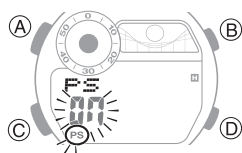

4. Press (D) to toggle between on and off.
[On]: Power Saving enabled.
[Off]: Power Saving disabled.
5. Press (A) to complete the setting operation.

Note

- While the setting is being configured, the watch will exit the setting operation automatically after about two or three minutes of non-operation.
- For details about Power Saving, refer to the information below.
[🔍 Power Saving Function](#)

Other Information

This section provides non-operational information you also need to know. Refer to this information as required.

City Table

City	Offset
UTC	Coordinated Universal Time
LIS	Lisbon
LON	London
MAD	Madrid
PAR	Paris
ROM	Rome
BER	Berlin
STO	Stockholm
ATH	Athens
CAI	Cairo
JRS	Jerusalem
MOW	Moscow
JED	Jeddah
THR	Tehran
DXB	Dubai
KBL	Kabul
KHI	Karachi
DEL	Delhi
KTM	Kathmandu
DAC	Dhaka
RGN	Yangon
BKK	Bangkok
SIN	Singapore
HKG	Hong Kong
BJS	Beijing
TPE	Taipei
SEL	Seoul
TYO	Tokyo
ADL	Adelaide
GUM	Guam
SYD	Sydney
NOU	Noumea
WLG	Wellington
PPG	Pago Pago
HNL	Honolulu
ANC	Anchorage
YVR	Vancouver
LAX	Los Angeles
YEA	Edmonton
DEN	Denver
MEX	Mexico City
CHI	Chicago
NYC	New York
SCL	Santiago
YHZ	Halifax

City	Offset
YYT	St. John's
RIO	Rio de Janeiro
FEN	Fernando de Noronha
RAI	Praia

- The information in the above table is current as of January 2022.
- Time zones may change and UTC differentials may become different from those shown in the table above.

Specifications

Accuracy at normal temperature :

±15 seconds a month

Timekeeping :

Hour, minute, second, month, day, day of the week
 a.m./p.m.(P)/24-hour timekeeping
 Full Auto Calendar (2000 to 2099) *
 * Year display on setting screen only.
 Summer Time

Diving Function :

Dive time

Measuring unit: 1 second

Measurement range: 23 hours, 59 minutes, 59 seconds (24 hours)

Interval time

Measurement unit: 1 minute

Measurement capacity: 47 hours, 59 minutes (48 hours)

10 log memory records (dive start date and time, dive time, interval time)

Tide Graph/Moon Graph function :

Tide Graph (with tide cycle display)

Moon phase display

Date selection

Time select (Tide Graph only)

World Time :

Current time display for 48 cities (31 time zones) around the globe

Summer time

Alarm :

Time alarms

Alarms: 5 (with one snooze alarm)

Setting units: Hours, minutes

Alarm tone duration: 10 seconds

Hourly time signal: Beep every hour on the hour

Stopwatch :

Measuring unit: 1/100 second

Measuring range

23 hours, 59 minutes, 59.99 seconds (24 hours)

Measurement Functions:

Elapsed time, split times, 1st and 2nd place finisher times

Timer :

Measuring unit: 1 second

Countdown range: 24 hours

Setting unit: 1 minute

Time up: 10-second beeper

Other :

High-brightness LED light (Full Auto Light, afterglow, 1.5 or 3-second illumination duration setting), power saving, battery power indicator, operation tone on/off

Power Supply :

Solar panel and one rechargeable battery

Battery operating time: Approximately 14 months

Conditions:

Not exposed to light under the conditions below.

- Illumination: 1.5 seconds/day
- Alarm: 10 seconds/day
- Display: 18 hours/day
- Diving Function
 - Number of dives: 50/year
 - Dive time: 60 minutes/dive

Note that battery operating time is reduced by illumination conditions and dive time duration in the Dive Mode.

Specifications are subject to change without notice.

Troubleshooting

World Time

Q1 The time for a World Time City is not correct.

The summer time setting (standard time/summer time) is wrong.

[Setting the World Time City](#)

Diving Function

Q1 I can't enter the Dive Mode.

The watch does not enter the Dive Mode while its charge is low or dead. Charge the watch before using it for diving.

Q2 The watch enters the Timekeeping Mode when it switches from dive time measurement to surface interval measurement.

If the charge becomes low while in the Dive Mode, the watch is not able to perform surface interval measurement. Charge the watch before using it for diving.

Q3 Measurement is in progress when I switch from the Timekeeping Mode to the Dive Mode.

This happens when a previous measurement is being continued. Enter the Dive Mode and reset measurement.

[Measuring Elapsed Dive Time](#)

Tide Level

Q1 There are errors in the tide information.

Since the high tide and low tide times and tide levels of the Tide Graph are calculated based on past data, the calculated data may be different from actual tide information.

Also note that the degree of the error can be affected by terrain, weather, and other conditions. Use the tide information of this watch for reference only.

Be sure to check accurate tide forecast information issued by various organizations, and do not use the tide information of this watch to determine tide levels used for navigation or any other purpose where there is the risk of danger.

Alarm and Hourly Time Signal

Q1 An alarm does not sound.

Is the watch's battery charged?

Keep the watch exposed to light until it recharges sufficiently.

[Charging](#)

Other than the above.

The alarm's settings may not be configured. Configure the alarm settings.

[Configuring Alarm Settings](#)

Q2 The hourly time signal does not sound.

Is the watch's battery charged?

Keep the watch exposed to light until it recharges sufficiently.

[Charging](#)

Other than the above.

The hourly time signal may be disabled. Enable the hourly time signal.

[Configuring the Hourly Time Signal Setting](#)

Charging

Q1 The watch does not work even though it is exposed to light.

The watch stops operating whenever the battery goes dead. Keep the watch exposed to light until it recharges sufficiently.

[☞ Checking the Charge Level](#)

Q2 [H], [M], and [L] are flashing on the display.

The watch is in the charge recovery mode. Wait until the recovery process is complete (about 15 minutes). The watch will recover more quickly if you place it in a brightly lit location.

- If an alarm, hourly time signal, illumination and/or other power-intensive functions are used within a short period of time, the charging capacity of the battery will drop and cause the watch to go into a charge recovery mode. Function availability will be temporarily limited, but functionality will return after the battery recovers.

[☞ Checking the Charge Level](#)



Q3 [CHG] is flashing on the display.

The charge level of the watch is extremely low. Immediately expose the watch to light to charge it.

[☞ Checking the Charge Level](#)

Other

Q1 I can't find the information I need here.

Visit the website below.

<https://world.casio.com/support/>