

# Frontier



**Owners Manual**

**Frontier V4 RWD**

**With Dynamic G90 controller**



[www.magicmobility.com.au](http://www.magicmobility.com.au)



YouTube: **MAGIC MOBILITY OZ**

# Contents

1.1	Intended Use .....	5
2	Safety and Damage Warnings .....	5
3	Safety .....	6
3.1	Transfers .....	6
3.2	Motor Vehicle Transport .....	6
3.3	Weight Limitations .....	7
3.4	Stairs and Escalators .....	7
3.5	Public Streets and Roadways .....	7
3.6	Transportation Products for your wheelchair .....	7
3.7	Stationary Obstacles: (Steps, Kerbs, Etc.) .....	7
3.8	Climbing or Descending an Incline .....	8
3.8.1	Maximum Recommended Incline .....	9
3.9	Removable Parts .....	9
3.10	Cornering Information .....	9
3.11	Electromagnetic Fields (for more information see Appendix B – Electromagnetic Interference (EMI)) .....	10
3.12	Positioning Belts .....	10
3.13	Weather Precautions .....	10
3.14	Reaching and Bending .....	10
3.15	Prescription Drugs/Physical Limitations .....	10
3.16	Alcohol/Smoking .....	11
4	Specifications .....	12
4.1	The Frontier V4 .....	12
4.2	Features and Options .....	12
4.3	Performance Attributes .....	12
5	Operating Instructions .....	12
5.1	Performance adjustments .....	12
5.2	Positioning .....	13
5.3	Freewheel Mode – pushing the power chair .....	13
5.4	Tilt in space seat option – if fitted .....	13
5.5	Power elevating seat option – if fitted .....	14
6	Joystick controls .....	15
6.1	Joystick power .....	15
6.2	Rain and Water .....	15
6.3	Joystick lead .....	15
6.4	Controller program .....	15
6.5	Hand control joystick operation – figure 3 – G90A .....	16
6.5.1	On/Off Button .....	16
6.5.2	Right Indicator (If Lights Are Fitted) .....	16
6.5.3	Horn .....	16
6.5.4	Left Indicator (If Lights Are Fitted) .....	17
6.5.5	Mode .....	17
6.5.6	ASK (Accessory Shortcut Key) .....	17
6.5.7	Lighting Menu Mode – If Fitted (N <sup>o</sup> t Standard) .....	18
6.5.8	Lock Mode – If Fitted (N <sup>o</sup> t Standard) .....	18
6.5.9	The Joystick .....	18
6.5.10	Charging .....	19
7	Batteries & Charging .....	19
7.1	Batteries .....	19
7.2	Battery Charging .....	19
7.3	Charging Procedure .....	19
	To get the maximum range from your batteries: .....	20
7.4	Public Transportation .....	20
7.5	Battery Disposal and Recycling .....	20

8	Care & Maintenance .....	20
8.1	General Guidelines.....	21
8.2	Batteries.....	21
8.3	Tyres and Castors.....	21
8.3.1	Tyre Inflation.....	21
8.3.2	Tyre Wear.....	23
8.4	Upholstery.....	23
8.5	Cleaning.....	23
8.6	Corrosion Protection.....	23
8.6.1	Paint scratches and chips.....	23
8.6.2	Beach, salt water and Coastal Areas.....	24
8.6.3	Snow and Ice, Salted Roads and Footpaths.....	24
8.6.4	Post-usage Cleaning.....	24
8.6.5	Preventative Maintenance.....	24
8.7	Storage.....	24
8.8	Transportation.....	25
8.9	Daily Checks.....	25
8.10	Weekly Checks.....	25
8.11	Annual Checks.....	25
9	Servicing.....	25
10	Fault finding.....	27
10.1	Limp Mode.....	27
10.2	Stuck Power Button.....	27
10.3	Joystick out of neutral at power up.....	27
10.4	Battery Warning Conditions.....	27
11	Warranty.....	28
11.1	Warranty policy.....	28
11.2	Non OEM parts, assembly by a 3 <sup>rd</sup> party and customisation.....	28
12	Head Office and Operations.....	28
	Appendix A - ANSI/RESNA WC/Vol 1 – Section 19 & ISO7176-19 restraint system; if fitted	29
	Appendix B – Electromagnetic Interference (EMI) .....	36

# Power Wheelchair Owner's Manual

Thank you for choosing a Magic Mobility Product. We are proud of the quality construction of every chair we build. This owner's manual explains the operation of your new chair. Please read it carefully as it contains important safety, care and maintenance information.

Magic Mobility's Power Wheelchair series may be custom made to measure and may vary in detail from chair to chair however this owners manual should cover all basic features and options. If your wheelchair has been customised especially for you, you can request additional instructions.

Magic Mobility endeavours to supply a wide variety of features and options to meet the needs of the user. However, final selection and specifications of the type of wheelchair to be used by any individual rests solely with the user and his/her healthcare professional capable of making such a selection. Magic Mobility can only stand by our performance specifications when genuine Magic Mobility components have been used. When third party parts or assembly has taken place, we strongly advise you seek additional instructions for use.

All of the information and specifications in this document are current at the time of printing. However due to our policy of continual product improvements we reserve the right to make changes at any time without notice. This may lead to slight variations between the illustrations and explanations in this manual and the model you have purchased.

## 1.1 Intended Use

The intended use of Magic Mobility Power Wheelchair's is to provide mobility to persons with a maximum weight of 182 kgs limited to a sitting position, that have the capability of operating a powered wheelchair.

If you experience any problems with your power chair that you are unable to solve, or if you do not feel capable of safely following any of the instructions and/or recommendations as contained in this manual, please contact your Magic Mobility dealer. You will find the model designation and serial number of the wheelchair on the base of the frame.

Magic Mobility is not liable for damage to property or personal injury arising out of unsafe use of a power chair. Magic Mobility is also not liable for any property damage or personal injury arising out of the failure of any person and/or user to following the instructions and recommendations set forth in this manual.

SEATING ARRANGEMENT	MAXIMUM USER WEIGHT
Nº seat elevator fitted	182 kg
Seat elevator or tilt fitted	155 kg

## 2 Safety and Damage Warnings

Throughout this manual, you will find the following safety and damage warnings.

	<b>WARNING!</b> This is a warning which, if ignored, may cause injury to yourself and other people
---	--



STOP! This is an instruction that, if not followed, may result in damage to your Power chair. It means 'do not do this' or 'do not let this happen'.

### 3 Safety

Please read and follow all instructions in this owner's manual before attempting to operate your power chair for the first time. If there is anything in this manual you do not understand, or if you require additional assistance for setup, contact your Magic Mobility Dealer before operating the wheelchair.

There are certain situations, including some medical conditions, where the power chair user will need to practice operating the power chair in the presence of a trained attendant. A trained attendant can be defined as a family member or care professional specially trained in assisting a power chair user in various daily living activities.

The contents of this manual are based on the expectation that a qualified healthcare professional has properly fitted the power chair to the user and the prescribing healthcare professional has trained the user in the operation of the wheelchair, the dangers that can be encountered and assured themselves that the user is capable of this.

Using your Magic Mobility product safely also depends upon your own good judgement and/or common sense, as well as that of your provider, caregiver, and/or health professional. Magic Mobility is not responsible for injuries and/or damage resulting from any person's failure to follow the warnings, cautions and instructions in this owner's manual.



WARNING! If you are going to be stationary in your power chair for an extended period of time, turn off the power. This will conserve battery power and remove the chance of unexpected chair movement through inadvertent joystick contact or from electromagnetic sources

#### 3.1 Transfers

It is recommended that you have a trained attendant present while you learn to transfer yourself. To reduce the chance of injury, we recommend:

- Be sure the power is turned off (See section **Error! Reference source not found.**)
- Be sure the Power chair is not in freewheel mode (See section 5.3)
- Ensure armrests and footrests are swung away or removed
- Position yourself as far back as possible in the power chair seat to prevent the power chair from tipping forward.



WARNING! Avoid putting all your weight on either armrests or footrests. This may cause the power chair to tip and cause injury



STOP! Avoid putting all your weight on either armrests or footrests. This may damage their supports.

#### 3.2 Motor Vehicle Transport

Wheelchair positioning belts are not designed with the intent of providing proper restraint during motor vehicle transportation. A WC19 and ISO7176-19 compliant system is available



from Magic Mobility. More information is contained in Appendix A - ANSI/RESNA WC/Vol 1 – Section 19 & ISO7176-19 restraint system; if fitted.

If it is necessary to use a transportation product such as a hoist or lift, Magic Mobility recommends that the manufacturer’s instructions and specifications are closely reviewed before using that product



### 3.3 Weight Limitations

Your power chair is rated for a maximum weight capacity of 182 kg. Do not carry passengers or heavy weights on any part of the wheelchair.

SEATING ARRANGEMENT	MAXIMUM USER WEIGHT
Nº seat elevator fitted	182 kg
Seat elevator or tilt fitted	155 kg

	WARNING! Exceeding the weight capacity voids your warranty and may result in personal injury.
	STOP! Exceeding the weight capacity voids your warranty and may result in damage to your power chair.

### 3.4 Stairs and Escalators

	WARNING! Never use your power chair to negotiate stairs or escalators. Always use an elevator or lift. You may cause injury to yourself and to others.
	STOP! Trying to negotiate stairs or escalators may result in damage to your power chair.

### 3.5 Public Streets and Roadways

	WARNING! You should not operate your power chair on public streets and roadways. This is in accordance with local traffic laws, which vary by country. Please check your local traffic laws. Be aware that it may be difficult for traffic to see you when you are seated on your power chair. Obey all local pedestrian traffic rules. Wait until your path is clear of traffic, and then proceed with extreme caution
---	---

### 3.6 Transportation Products for your wheelchair



If it is necessary to use a transportation product such as a vehicle hoist or lift, Magic Mobility recommends that the manufacturer’s instructions and specifications are closely reviewed before using that product.

### 3.7 Stationary Obstacles: (Steps, Kerbs, Etc.)

Proceed with extreme caution when driving near raised surfaces, unprotected ledges, and/or drop-offs (kerbs, porches, stairs, escalators, lifts etc). Always approach an obstacle so both

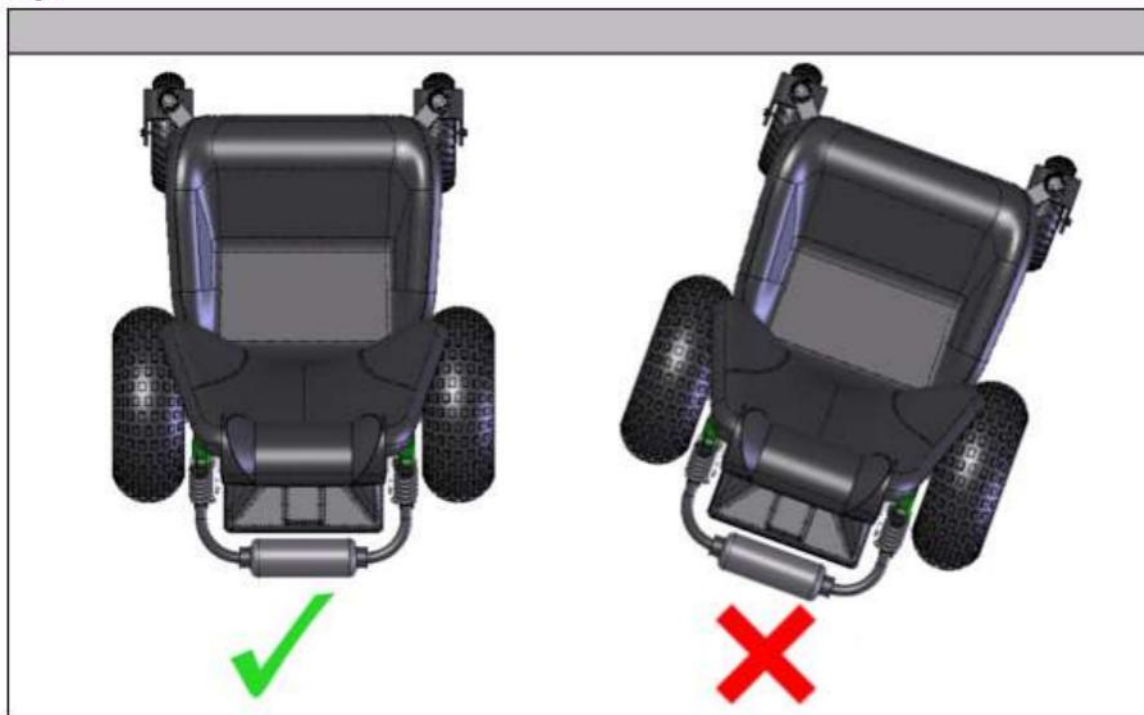
front wheels touch that obstacle together. Never attempt to climb a kerb or obstacle at an angle.



	<b>WARNING!</b> Do not attempt to have your power chair climb or descend an obstacle that is higher than 5cm unless you have the assistance of an attendant. Never try to travel backwards down any step, kerb, or other obstacle. This may cause the power chair to tip and cause personal injury.
	<b>STOP!</b> Trying to negotiate stairs or escalators may result in damage to your power chair.

### 3.8 Climbing or Descending an Incline

When climbing an incline, try to keep your power chair moving; however do not use excessive speed.

When driving down an incline, set your power chair to the slowest speed setting and drive in the forward direction only. If your power chair starts to move down the incline faster than you anticipated or desired, allow it to come to a complete stop by releasing the joystick. Once the chair has stopped push the joystick forward slightly to ensure a safely controlled descent.

The following advice is recommended for your safety:

- Stop before climbing an obstacle. Approach slowly until castors contact the obstacle. Apply power and the action of the chair will lift the castors over the obstacle. Weight is transferred to the drive wheels providing traction and motor strength to power the chair over the obstacle.
- Do not drive at an angle up or down the face of the incline. Drive your power chair straight up or down the incline. This greatly reduces the possibility of tipping the chair over
- Avoid potentially hazardous inclines e.g. areas covered with snow, ice, mud, cut grass, or wet leaves.

- When on any sort of an incline or decline, never place the power chair in freewheel mode while seated on it or standing next to it.
- Never attempt to travel backwards down an incline.

	WARNING! Always exercise extreme caution on inclines and follow the advice above to reduce the risk of personal injury
---	--



### 3.8.1 Maximum Recommended Incline

Most public access ramps have a maximum gradient 1 in 14 (AS1428.1). Therefore, Magic Mobility recommends that the maximum slope of an incline you attempt to safely ascend or descend on your power chair does not exceed a 1 in 14 gradient.

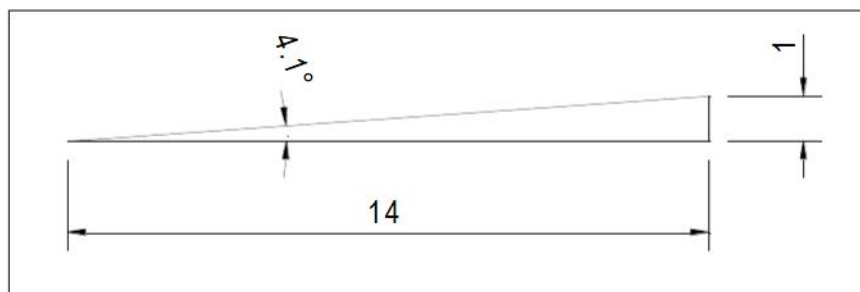
	WARNING! Any attempt to climb or descend a slope steeper than 1 in 14 gradient may put your power chair in an unstable position and cause it to tip, resulting in personal injury.
---	--



### 3.9 Removable Parts

	WARNING! Do not attempt to lift or move a power chair by any of its removable parts. This may result in personal injury.
	STOP! Do not attempt to lift or move a power chair by any of its removable parts. This may cause damage to the chair.

### 3.10 Cornering Information

Excessively high cornering speeds can create the possibility of tipping. If you feel that you may tip over in a corner, immediately reduce your speed and steering angle (i.e. lessen the sharpness of the turn)

The following advice is recommended for your safety:

- Reduce cornering speed
- Reduce steering angle
- Beware of uneven, rough and slippery terrain
- Avoid turning on inclined surfaces
- Be aware of changing surfaces - such as passing from a paved area to a gravel area at high speed while turning
- Avoid abrupt directional changes.



**WARNING!** When cornering, lower your speed and follow the advice above to reduce the risk of personal injury

### **3.11 Electromagnetic Fields (for more information see Appendix B – Electromagnetic Interference (EMI))**

Your power chair's performance may be influenced by electromagnetic fields caused by mobile telephones or other radiating devices, such as hand-held radios, radio and television stations, wireless computer links, microwave sources, and pagers.

Your power chair may also be a source of electromagnetic and radio frequency interference. Be aware that your power chair may affect the performance of alarm systems and other radiating devices.



**WARNING!** Turn off your power chair when using products, which emit electromagnetic fields. This will eliminate the possibility of unintended movement caused by electromagnetic sources. Failure to take this precaution may result in personal injury

### **3.12 Positioning Belts**

Do not use the positioning belt on your power chair as a restraint for transportation in a motor vehicle.

It is the obligation of the purchasers, therapists and other healthcare professionals to determine if a positioning belt is required to ensure the safe operation of this equipment by the user.



**WARNING!** Ensure your positioning belt is fastened securely. Serious personal injury may result if you fall from the power chair.

### **3.13 Weather Precautions**



**WARNING!** Do not operate your power chair in icy or slippery conditions or on salted surfaces (i.e.; footpaths and roads). Such use may adversely affect the performance and safety of your power chair, resulting in an accident and personal injury.

### **3.14 Reaching and Bending**



**WARNING!** Do not bend, lean, or reach for objects, if you have to pick them up from the floor we suggest you use a specially designed "Pick Up Stick". Movements such as these may cause your power chair to tip, possibly resulting in personal injury.

### **3.15 Prescription Drugs/Physical Limitations**

Consult your physician if you are taking prescribed or over-the-counter medication or if you have certain physical limitations.



**WARNING!** Some medications and limitations may impair your ability to operate your power chair in a safe manner, possibly resulting in personal injury to yourself and others.

### 3.16 Alcohol/Smoking



WARNING! Do not operate your power chair while you are under the influence of alcohol, as this may impair your ability to operate your power chair in a safe manner, resulting in personal injury to yourself and others.



WARNING! It is strongly recommended that you do not smoke cigarettes while seated in your wheelchair. The power chair has passed the necessary flammability requirements, but it is strongly advised to keep ashtrays at a safe distance from seat cushions, to ensure cigarettes are completely extinguished before disposal, and we strongly advise against leaving lit cigarettes unattended.

## 4 Specifications

### 4.1 The Frontier V4

A power chair is depicted below. This figure will help you identify some of the features referred to throughout this manual.

### 4.2 Features and Options

Every individual has different requirements and at Magic Mobility we pride ourselves on being able to meet the needs of most people. Many aspects of the power chair are customisable including, but not limited to controllers, seats, seat back recline mechanisms, armrests, headrests and leg rests. Please contact your Magic Mobility Dealer to discuss any additional requirements, including advice on how to operate these features.



### 4.3 Performance Attributes

Information regarding the performance attributes and controlled testing results of the power chair may be obtained from the power chair manufacturer. If you would like access to this information, please contact your Magic Mobility Dealer.

All results meet at least the minimum performance requirements of AS3695



## 5 Operating Instructions

The speed and direction of the power chair is controlled with by the joystick

- Turn on your power chair (see figure 3 in section 6.5.4)
- Use the joystick to control the speed and direction of travel

### 5.1 Performance adjustments

Performance adjustments to your power chair should only be made by professionals of the healthcare field, or by persons fully conversant with both this process and the driver's capabilities.

	<p>WARNING! Changing the performance settings could adversely affect your power chair. You may cause injury to yourself and to others.</p>
	<p>STOP! Incorrect settings could cause damage to the chair and to surrounding property.</p>

## 5.2 Positioning

If your power chair was configured at your Magic Mobility Dealer, please consult your health care professional before changing the seat position or making any other adjustment. Some adjustments may degrade your power chair's performance and safety by changing its centre of gravity.

## 5.3 Freewheel Mode – pushing the power chair

Located on each side of the chair, in front of each drive wheel is a motor release lever (see figure 2). To disengage the built-in or “running” brakes simply pull the levers towards you on each side.



Figure 2 Motors engaged

The wheelchair controls will not function and the “status” light on the joystick will flash when the chair is in free-wheel mode. This feature has been intentionally incorporated to protect the user from unsafe situations. These levers are intended for use by the attendant.

Don't forget to push the levers back in again firmly after manually positioning the chair



	<p>WARNING! Do not use your chair in freewheel mode or attempt to place your chair into freewheel mode without an attendant present. You may cause injury to yourself and to others. Do not place your power chair in freewheel mode while on an incline. The chair could roll uncontrollably on its own, leading to injury to yourself and others. WARNING! When the power wheelchair is in freewheel mode, the braking system is disengaged.</p>
---	--

## 5.4 Tilt in space seat option – if fitted

To operate the Tilt in space Seat:

- Bring your power chair to a complete stop on a flat level surface.
- Always fasten the positioning belt when operating the Tilt In Space seat.

- Push the 'Accessory Mode Selection' button on the DX2 joystick. Select Tilt In Space by moving the joystick left or right. Once the Tilt In Space option is highlighted, moving the joystick forward or backwards will operate the function.
- Once the seat reaches its highest tilt angle, the tilt action stops; release the joystick at this point.
- Before driving, return the seat to its upright position. When returning to the upright position, always be sure that the mechanism has reached its lowest limit or normal seated position.

	<p>WARNING! Never tilt the seat from its upright position on an inclined surface or on bumpy or uneven surfaces. Never raise the Tilt In Space seat while your power chair is in freewheel mode. Failure to heed this warning can result in the power chair tipping over and causing personal injury.</p>
	<p>STOP! Do not put your fingers, toes or anything into the tilt mechanism while it is operating. Serious personal injury will occur.</p>

### 5.5 Power elevating seat option – if fitted



The power elevating seat will allow more freedom and independence, by extending your level of reach. The seat height can be adjusted to match a surface to which you are transferring. When the seat is fully elevated, the user is closer to eye level of standing persons enabling more enjoyable interactions.

Seat elevators are sometimes referred to as scissor lifts; this for good reason. Under no circumstances should you put your hands, fingers, toes or any part of your body in the seat elevator mechanism while it is operating. Be careful that nobody else has any part of their body in the seat elevator mechanism while it is working.

To operate the power elevating seat:

- Bring your power chair to a complete stop on a flat level surface.
- Always fasten the positioning belt when operating the power elevating seat.
- Push the 'Accessory Mode Selection' button on the DX2. Select power elevating seat by moving the joystick left or right. Once the power elevating seat option is highlighted, moving the joystick forward or backwards will operate the function.
- Once the seat reaches its highest elevation, the action stops; release the joystick at this point.
- Before driving, always be sure that the mechanism has returned the seat to its lowest position.

The power seat elevator is fitted with a system that reduces the speed of the power wheelchair when the seat has been elevated a small amount.

	<p>WARNING! Fasten the positioning belt when using the seat elevator          WARNING! Never elevate the seat from its lowest position on an inclined surface          WARNING! Never raise the seat when crossing bumpy or uneven surfaces          WARNING! Do not put the power wheelchair into freewheel mode with the seat elevated          WARNING! Maintain recommended tyre pressures for good stability</p>
	<p>STOP! Do not put your fingers, toes or anything into the scissor mechanism while it is operating. Serious personal injury will occur.</p>

## 6 Joystick controls

A detailed manual for the DX2 joystick is available from Dynamic Control's website: [www.dynamiccontrols.com](http://www.dynamiccontrols.com).

The joystick controls may be customised and may be one of a number of different models depending upon users requirements. This manual contains detailed information on the standard joystick control.

### 6.1 Joystick power

If the power chair begins to move in an unexpected manner, immediately release the joystick and turn the wheelchair off. Unless the joystick is damaged, this should stop your power chair.

If the joystick is not in the neutral (centre) position when you turn on the power, you may cause a fault in the system. Releasing the joystick and turning the power off and on again will reset the system.



**WARNING!** Always turn the power off when you are stationary to prevent unexpected movement.

### 6.2 Rain and Water

The joystick hand control unit IS NOT WATERPROOF. The joystick module is splash proof but may be permanently damaged if water transgresses the rubber seals (this damage is not covered under warranty).

We recommend carrying a plastic bag large enough to cover the joystick module and the user's hand, in case of rain.

### 6.3 Joystick lead

If for any reason, the joystick lead is disconnected take care when reconnecting, do not force the plug into the socket. The lead is polarised and should only be fitted one way.



**STOP!** Forcing the plug into the socket the wrong way can permanently damage the electronics system. Also, do not place the lead so that it can be pinched in the seat frame or the power base frame.

### 6.4 Controller program

The controller program affects speed, acceleration, deceleration, and braking. The drive mode settings are preset at the factory. If your Magic Mobility Dealer/ healthcare professional changes these settings, please make note of these changes.



**WARNING!** Do not attempt to reprogram your chair. Only the power chair manufacturer, an authorised representative of the manufacturer, or a trained service technician should program the controller.

## 6.5 Hand control joystick operation – figure 3 – G90A

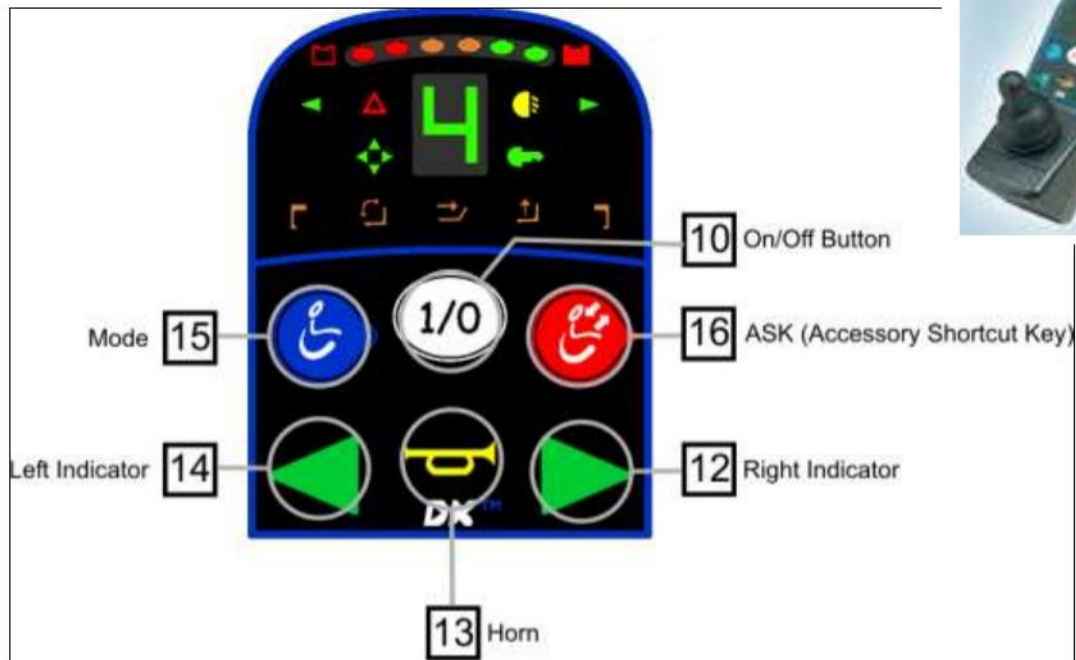

Hand Controller DXREMG90A

### 6.5.1 On/Off Button

	<p>To turn the power on press the On/Off button.</p> <p>The current battery charge will be indicated and the System Status LED will illuminate and not flash.</p> <p>Press the On/Off button again to turn the power off.</p>
--	---

### 6.5.2 Right Indicator (If Lights Are Fitted)

	<p>To turn the Right Indicator on/off, press and release ('short press') the Right Indicator button.</p> <p>To toggle the Hazard Lights on/off, press and hold ('long press') the Right Indicator button.</p>
--	---

### 6.5.3 Horn

	<p>Pressing the Horn button will sound the horn for as long as the button is pressed.</p>
--	---

#### 6.5.4 Left Indicator (If Lights Are Fitted)

	<p>To turn the Left Indicator on/off, press and release ('short press') the Left Indicator button.</p> <p>To toggle the Headlights on/off, press and hold ('long press') the Right Indicator button.</p>
---	--

#### 6.5.5 Mode

	<p>Each press of the Mode button will increment the drive profile, up to the maximum configured value and then back to profile</p> <p>The current drive profile will be shown in the 7 Segment Display.</p>
---	---

	<p><b>Note:</b> If the chair is driving and the Mode button is pressed, the drive profile will increase by a single increment with each press until the maximum configured value is reached. The Mode button does not enter the accessory modes.</p>
---	--

#### 6.5.6 ASK (Accessory Shortcut Key)

	<p>If you are in Drive Mode, a press of the ASK button will navigate you to the last used accessory function, e.g. actuator control. If you are already in Accessory Mode, a press of ASK will take you to the next available accessory mode, e.g. ECU or lighting. To return to Driving, simply press the Mode button.</p> <p>This feature significantly reduces the complexity and number of key presses to access common features.</p>
---	---

	<p><b>Note:</b> If the chair is driving and the ASK button is pressed, the command is ignored until the chair has stopped.</p>
---	--

### 6.5.7 Lighting Menu Mode – If Fitted (N<sup>o</sup>t Standard)

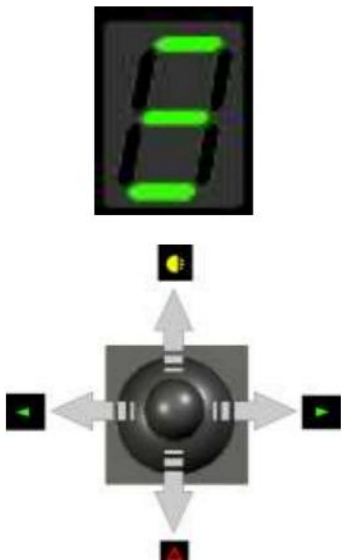
	<p>When in Lighting Menu Mode, the 7 Segment display shows 3 horizontal lines.</p> <p>Moving the joystick forward will toggle the Headlights.</p> <p>Moving the joystick left will toggle the Left turn Indicators.</p> <p>Moving the joystick right will toggle the right turn Indicators.</p> <p>Moving the joystick backward will toggle the Hazard Lights.</p>
---	--

### 6.5.8 Lock Mode – If Fitted (N<sup>o</sup>t Standard)

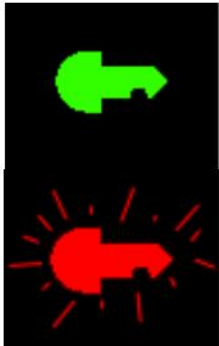
	<p>The Key Lock system uses a magnetic key to power the wheelchair down to prevent subsequent unauthorized driving.</p> <p><b>To Lock the system:</b> Swipe the magnetic key across the key symbol on the G90A Remote. The system will beep and automatically power itself down.</p> <p><b>To Unlock the system:</b> Press the On/Off button to power up the system. The flashing red key symbol shows the system is locked. Swipe the magnetic key across the key symbol the LED will stop flashing the chair may be driven as normal. If the wheelchair is not unlocked, G90 will automatically turn itself off.</p>
--	--

### 6.5.9 The Joystick

	<p>Moving the joystick will cause the power chair to drive in that direction. The amount of joystick movement will determine the speed that the power chair will move in that direction.</p> <p>Joystick Out of Neutral at Power up (OONAPU) occurs if the joystick is out of neutral when switched on. If this happens the System Status LED will flash constantly. Releasing the joystick within a few seconds will cancel the indication otherwise a 'latching fault' will occur.</p>
---	--

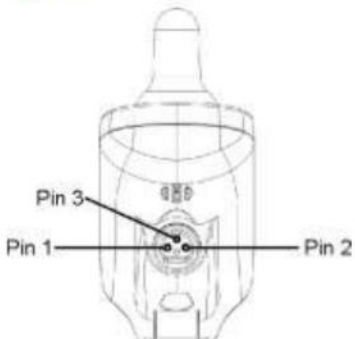

### 6.5.10 Charging

<p>Fig3-16</p> 	<p>Plug the battery charger into the charging socket located at the front of the G90 Remote.</p> <p>Driving is inhibited while the system is being charged as denoted by '-' displayed on the 7 segment display. However, it is possible to use accessory functions e.g. actuators.</p> <p>Once the Battery Charger displays a 'full' battery charge, the battery charger plug may be removed.</p>
--	--

## 7 Batteries & Charging

### 7.1 Batteries

Your Power Chair uses high quality long lasting gel cell batteries that are sealed and maintenance free. There is no need to check the electrolyte fluid level they contain. Despite their similarity to automotive batteries, they are not the same. Automotive batteries are not designed to handle a long, deep discharge, and are also unsafe for use in power chairs.

	<p>WARNING! Battery posts, terminals, and related accessories contain lead and lead compounds, wash your hands after touching.</p> <p>WARNING! Corrosive chemicals are contained in the batteries. Use only AGM or gel-cell batteries to reduce the risk of leakage or explosive conditions.</p> <p>WARNING! When fitting alternate batteries, ensure their terminal posts cannot touch any part of the wheelchair frame</p>
	<p>STOP! Automotive batteries and chargers are unsafe for use in power wheelchairs</p>

### 7.2 Battery Charging

We recommend using only a high quality dual rate intelligent battery charger with your Power Chair. Only use the supplied off-board charger unless otherwise approved by Magic Mobility. Do not use an automotive-type battery charge.

Fully recharge any new batteries prior to use. Operate the power wheelchair around the house and grounds; do not travel too far until you are accustomed to the controls. After this first use; fully charge the batteries. After 4 or 5 cycles, the batteries will perform to their fullest potential.

The charger will not operate after the batteries have been discharged to an extremely low voltage. If this happens, call your Magic Mobility Dealer for assistance.

### 7.3 Charging Procedure



Battery Charging is via a socket within the joystick module. When a charger is plugged in, the joystick unit recognises the unit is plugged in and chair driving is inhibited.

The following procedure is valid for the recommended charger brand - consult your separate charger instructions if supplied with an alternative charger.

1. Ensure the wheelchair is turned off.
2. Always make sure that the charger is turned off before plugging it into the wheelchair.
3. Plug the charger into the charging socket on the joystick module.
4. Please consult the instruction manual supplied with your charger for detailed instructions

The following advice is recommended to help care for your batteries:

- Keep your batteries fully charged and avoid deeply discharging your batteries.
- The wheelchair will require charging for 8 to 10 hours for a full charge. Charging the batteries for short periods will shorten the life of the batteries.
- Do not charge the batteries for more than 24 hours at a charging cycle if possible.
- If the power wheelchair is used every day then the batteries should be charged overnight every night.

	<b>WARNING!</b> Always protect the batteries from freezing and never charge a frozen battery. Doing so can result in personal injury and damage to the battery
	<b>STOP!</b> Do not put the charger on the seat of the wheelchair when charging as the charger can become quite warm. Always put the charger on the floor near the chair when in use.

To get the maximum range from your batteries:

- Fully charge the batteries prior to the trip
- Avoid stop-go driving; try to maintain a constant speed
- Try to avoid inclines
- Limit baggage weight carried

#### **7.4 Public Transportation**

The Gel Cell batteries are Federal Aviation Administration (FAA) approved, allowing safe transportation on aircraft, buses and trains. However, Magic Mobility recommends that any specific requirements of the carrier are checked in advance.

#### **7.5 Battery Disposal and Recycling**

If you encounter a damaged or cracked battery, contact your Magic Mobility Dealer for instructions on disposal. Your Magic Mobility Dealer will also have all the necessary information on battery recycling, which is our recommended course of action.

## **8 Care & Maintenance**

Like any motorised vehicle, your power chair requires routine maintenance checks. You can perform some of these checks, but it is recommended that every 12 months the chair is inspected by a factory authorised service facility. Repairs or replacements should only be carried out with manufacturer-approved components to assure proper performance (see section 9, Servicing).



**STOP!** Do not use parts, accessories, or adapters other than those authorised by Magic Mobility. This may void your warranty and cause damage to your power chair.

## 8.1 General Guidelines

Do not expose your power chair to any type of moisture at any time (rain, snow, mist, salt water, or wash). Such exposure can damage your power chair. Should your power wheelchair come into contact with water, dry as thoroughly as possible with a towel and then allow it to sit in a warm room for 10-12 hours to dry. Check the joystick operation and brakes before using your power wheelchair. If there are any doubts or inconsistencies with your wheelchair, please contact your Magic Mobility dealer

Avoid knocking or bumping the controller, especially the joystick.

Keep the controller clean

Avoid exposure to extreme temperatures

Do not place the controller cable so it may be pinched in any of the seat or power base frames



**STOP!**  
DO NOT leave the power wheelchair in rain or a storm of any kind.  
DO NOT use the power wheelchair in a shower or leave it in a damp bathroom whilst taking a shower.  
DO NOT leave power wheelchair in a damp area or outdoors for any length of time.  
Direct exposure to rain or damp will cause electrical and mechanical malfunctions and may cause the chair to prematurely rust.

Some parts of the power wheelchair are susceptible to extremes of temperature. It is possible for the batteries to freeze. The temperature at which the batteries freeze depends on a number of factors including their chemical composition, the level of charge and their usage. At elevated temperatures; the power wheelchair may operate at a reduced speed. This a safety feature built into the controller to protect the motors and other electrical components.



**WARNING!** Your wheelchair has electric motors and must NEVER be driven through water, into rivers, creeks and the sea.

## 8.2 Batteries

The batteries used in your power chair are sealed, no maintenance gell cells and require only correct charging procedures - see 7.2 Battery Charger. Typically these batteries would last 1 to 2 years; depending upon type of usage.

## 8.3 Tyres and Castors

### 8.3.1 Tyre Inflation

	Tyre Description	Recommended Optimum Operating Pressure	Maximum Tyre Pressure according to tyre capacity
<b>OFFROAD V4 – HYBRID and Compact version</b>			
Drive Tyres	14-3 pneumatic	<b>35 psi</b> (241kPa)	30 – 50 psi

			(207 – 344 kPa)
Drive Tyres	12 ½ x 2 ¼ pneumatic	<b>35 psi</b> (241kPa)	30 – 40 psi (207 – 275 kPa)
Castors	200mm MCP Pneumatic	<b>36 psi</b> (248kPa)	36 psi 248 kPa
<b>OFFROAD V4 ALL TERRAIN</b>			
Drive Tyres	Black, Low Pressure, Knobby	<b>3.6 psi</b> (25 kPa) Also, see chart below	3.6 - 24 psi (25 – 165 kPa)
Castors	250mm Pneumatic (All Terrain Model)	<b>36 psi</b> (248kPa)	36 psi 248 kPa

Lower tyre pressures provide more traction in mud, sand and snow. For use on firmer surfaces, tyre pressures may be increased up to a maximum of 8 psi depending upon the weight of the user, their preferences and driving capability. The chart below may be of some assistance when increasing tyre pressures. **For use on your Magic Mobility ALL TERRAIN wheelchair: It is not recommended that tyre pressures greater than 8 psi are used.**



#### ALL TERRAIN TYRE INFLATION PRESSURE AND USER WEIGHT

Tyre pressures should be checked weekly. All pneumatic tyres are fitted with automotive type valves and can be inflated using most typical automotive hand and foot type pumps as well as service station air outlets.



**STOP!** Under inflated tyres may be dangerous and can leave the tyres prone to punctures. Failure to use the correct inflation pressure can result in reduced performance or cause an unsafe situation to occur



**STOP!** Over inflated tyres may cause the tyre to explode and cause bodily harm. The recommended tyre pressure is also listed on the sidewall of the tyre

### **8.3.2 Tyre Wear**

Tyre wear varies greatly depending on usage (from months to years), but no matter what sort of time your tyres last this is mostly governed by your typical daily requirements. To achieve the most from your tyres it is important to have them correctly inflated. Always use manufacturer recommended parts. Replace tyres when the tread pattern wears to less than 2mm in depth as tyres will start to lose safe traction and can be more prone to puncture.

### **8.4 Upholstery**

The power chair upholstery may be cleaned using mild soap and water. Avoid getting water into any electric components. Never use any chemicals to clean a vinyl seat, as they may cause the seat to become slippery, or dry out and crack. A general purpose upholstery cleaner may be used on velour.

Upholstery life may be affected by skin oils and human sweat particularly that caused by particular medications. It is recommended that should cracking or significant wearing of the upholstery occur, it should be replaced.

### **8.5 Cleaning**

Your power chair has a powder coated metal frame that allows it to be easily wiped clean with a damp cloth. Never hose off or pressure clean your power chair or place it in direct contact with water.

### **8.6 Corrosion Protection**

The V6 power chair has been manufactured using a range of processes that have been developed to resist corrosion. Although all effort has been made to ensure the long-term durability of the product we cannot guarantee that the wheelchair will remain corrosion-free for the duration of its usable life. Prevention, protection and maintenance are essential to reducing the risk of corrosion on the wheelchair.

The most common causes of corrosion to the power chair are:

- Chipping or scratching of paint or undercoat caused by impact with rocks or other hard objects.
- The accumulation of grit salt, dirt and moisture on the chassis components.
- Exposure to highly corrosive environments such as the beach and coastal areas, rivers and creeks.

#### **8.6.1 Paint scratches and chips**

If your power chair chassis or any other steel components are scratched or chipped leaving the bare metal exposed it is recommended to undertake the following steps to repair the paintwork:

- Lightly sand the exposed area to flatten it and remove any loose edges of paint and any chipping that has occurred. Ensure any surface corrosion has been removed in this process.
- Apply a cleaning solvent to the area to remove any dust, impurities and oils.
- Apply primer over the area to be touched up.

- After allowing adequate drying time, apply the touch-up paint ensuring that it covers all exposed areas. When dry, the area should now be protected from further corrosion.

If it is not practical to perform the above steps, products that neutralise rust and prevent it from spreading can be used such as the many commercially available 'rust converter' products.

### **8.6.2 Beach, salt water and Coastal Areas**

Salt water and the surrounding environment is highly corrosive.

Exposure to coastal areas will also increase the likelihood of corrosion occurring on the power chair even if it is not used on the beach. Coastal air generally has a far higher salt content than inland areas. The highest coastal corrosion rates are generally within approximately 500 metres (1640 ft) of the shoreline. If you live in a coastal area or regular use the wheelchair near the beach please see section 8.6.4 below for maintenance advice.

### **8.6.3 Snow and Ice, Salted Roads and Footpaths**

Avoid using the wheelchair on salted surfaces where possible as the salt can have a detrimental effect on many of the components used in the wheelchair. If the wheelchair has been driven on wet, icy or salted surfaces please see section 8.6.4 below for maintenance advice.

### **8.6.4 Post-usage Cleaning**

When the power chair has been used in coastal, wet or salty environments, we recommend that extra cleaning care is taken to reduce the risk of rusting. When returning from your drive all parts should be wiped down with warm water on a cloth. Under no circumstances should the wheelchair be hosed down. The wheelchair should then be left in a warm and dry environment. It may also help to blow as much of the sand and/or salt off as possible.

### **8.6.5 Preventative Maintenance**

Prior to using your wheelchair in wet or corrosive environments it is suggested that you protect your wheelchair by thoroughly coating all metal surfaces with a water dispersant. Common products include oiled-based spray applicants (eg. WD40) or lanolin-based dispersants (eg. Lanotec). This coating should provide a barrier between the water and the painted steel surfaces of your power chair.

A lubricant (such as a WD40) can be sprayed on the lift and tilt mechanism, if fitted, as protection.



The underside of the wheelchair (battery box and chassis components) can be sprayed by using a ramp another standards-approved lifting device to enable access to these areas.

	<p><b>CRITICAL! Your wheelchair has electric motors and must NEVER be driven through water, into rivers, creeks and the sea.</b></p>
---	--

## **8.7 Storage**

Store your Magic Mobility power chair in a warm dry environment. If you do not use your power chair regularly, it is recommended that the batteries be charged at least once per week.

If you are storing your power chair for an extended period of time, please contact your Magic Mobility Dealer who can give you advice on disconnecting the batteries and blocking up the power chair to avoid flat-spotting the tyres

	WARNING! Battery posts, terminals, and related accessories contain lead and lead compounds, wash your hands after touching.
	WARNING! Corrosive chemicals are contained in the batteries. Use only AGM or gel-cell batteries to reduce the risk of leakage or explosive conditions.

## 8.8 Transportation

Always be sure your power chair and its components are properly secured when it is being transported. Please contact your Magic Mobility Dealer for advice regarding packing and shipping your particular chair.

## 8.9 Daily Checks

Turn off the controller and check the joystick. The joystick should return to centre and not be bent or damaged in any way. Ensure the joystick boot is not torn or cracked where water can enter and that all electrical connections are secure.

	STOP! Do not use the joystick if the boot is torn or cracked. If the joystick boot becomes torn or cracked, ensure it is replaced IMMEDIATELY.
--	--

## 8.10 Weekly Checks

- Visually inspect the controller harnesses. Ensure they are not frayed and have any wires exposed.
- Check the tyre pressure is to the specification as detailed in section **Error! Reference source not found. Error! Reference source not found.**
- Check the tyres for wear
- Check the brakes by pushing the joystick slowly forward until you hear the electric brakes click. Immediately release the joystick. The brakes should operate within a few seconds of moving the joystick. Repeat this test by pushing the joystick rearwards, left and then right.
- Keep your power chair clean and free from foreign material.

	STOP! If any of the above checks reveal a problem, please see your Magic Mobility Dealer for repair.
---	--

## 8.11 Annual Checks

It is highly recommended to service your power chair annually. Take your power chair to your Magic Mobility Dealer to ensure it is functioning correctly (see **Error! Reference source not found. Error! Reference source not found.**)

# 9 Servicing



Please contact your Magic Mobility Dealer to arrange your annual service. Your local representative can also discuss the availability of loan (rental) units during repairs and servicing. It should be noted that many of our power chairs are highly customised and a loan (rental) chair may not be appropriate.

If you notice symptoms such as motor noise, frayed harnesses, damaged connectors, uneven tyre wear, unusual motion or broken parts or anything else that may be a cause for concern between services, please also contact your Magic Mobility Dealer immediately. If required, Head Office can help you find your nearest Dealer (see section 12).

Set-Up of the Electronic Control Unit is to be performed ONLY by individuals authorised by Magic Mobility. The final tuning adjustments of the controller may affect other activities of the wheelchair.

	<p>STOP! If non-certified individuals perform any work on these units, the warranty is void and damage to the equipment could occur.</p>
---	--

Do not modify, or have your power chair modified in any way not authorised by Magic Mobility. Unauthorised changes constitute remanufacturing of the wheelchair. The person or group who make the changes will have full liability of the wheelchair under the Therapeutic Goods Act (TGA).

	<p>WARNING! Unauthorised modifications void your warranty and may result in personal injury.</p>
	<p>STOP! Unauthorised modifications void your warranty, constitute remanufacturing and may render your chair unsafe.</p>

## 10 Fault finding

During fault conditions the chair either will not drive or drives very slowly.

### 10.1 Limp Mode

If the DX system detects a fault that does not demand the wheelchair be stopped completely; it will go into 'Limp Mode'. This enables the wheelchair to be driven to a safe place at a reduced speed.

### 10.2 Stuck Power Button



If the power button is pushed and not released; the system switches off. To unlock the system, press the on/off button and then press the horn button twice within 10 seconds (Section 6.5.3)

### 10.3 Joystick out of neutral at power up

If the joystick is not in the centre position when the system is switched on; the wheelchair will not drive. This is to prevent inadvertent movement. If the joystick is returned to the centre within 4 seconds the chair will then drive normally. If the joystick is not returned to centre within 4 seconds, the DX2 system must be switched off and then on again.

### 10.4 Battery Warning Conditions

Check the batteries are charges. If the charge icon is red, put the chair on charge immediately

Warning Icon	Meaning
	Battery overcharged. <ul style="list-style-type: none"><li>• Slow down and turn on the lights (if fitted).</li></ul>
	Battery completely empty. System turns off. <ul style="list-style-type: none"><li>• Recharge.</li></ul>

Note if the batteries are allowed to discharge completely, they may not recharge (see section 7) in the event of this happening please contact your Magic Mobility Dealer for assistance.

# 11 Warranty

## 11.1 Warranty policy

This wheelchair is provided with a 12 month Limited Warranty on the parts and workmanship contained within.

This warranty does not cover:

- wear and tear, tyres, batteries, upholstery
- freight to, or from, the manufacturer, that is, the chair must be returned to the factory or Dealer, freight pre-paid, for all warranty repairs.
- breakages / damage to either the motors, gearboxes, or axle shafts caused by misuse of the wheelchair.
- faults, failures or excessive wear caused by lack of appropriate maintenance and regular servicing by authorized repairers as outlined within this owners manual.

We will, at our discretion, repair / replace items that we consider were faulty at time of manufacture.

The availability of replacement units is subject to the discretion of the provider, not the manufacturer. For more information regarding replacement units, contact your Magic Mobility Dealer.

Upon acceptance of goods at delivery the purchaser accepts the "Terms & Conditions of Sale"

## 11.2 Non OEM parts, assembly by a 3<sup>rd</sup> party and customisation

If non Magic Mobility parts are fitted to the wheelchair, Magic Mobility is not responsible for their compatibility, performance or instructions for use. Please refer to the relevant manufacturers manuals for appropriate use. Magic Mobility wheelchairs pass AS3695 in a standard wheelchair configuration, all variants and non Magic Mobility components are not tested. In addition, if non Magic Mobility parts are fitted, it could void the warranty as Magic Mobility cannot guarantee their compatibility. In the instance where non Magic parts are fitted, then they are fitted at your own risk/risk of the final person who assembles the wheelchair. In the instance where parts are assembled by a third party agent, they take the responsibility of being the manufacturer.

# 12 Head Office and Operations



2/112 Browns Road  
Noble Park, Vic. 3174  
Australia

Phone: +61 3 8791 5600  
Email Address: [admin@magicmobility.com.au](mailto:admin@magicmobility.com.au)  
Web Site <http://www.magicmobility.com.au>

© Copyright Magic Mobility 2014

## Appendix A - ANSI/RESNA WC/Vol 1 – Section 19 & ISO7176-19 restraint system; if fitted

The wheelchair is not provided with a wheelchair anchored belt restraint as standard. It must be requested at the time of ordering the wheelchair or it can be retrofitted later on by a Magic Mobility Representative.

Once fitted; the wheelchair complies with the requirements of RESNA WC-4, Section 19 and ISO7176-19.

It is recommended that people who use wheelchairs should transfer to the vehicle seat and use the vehicle-installed occupant restraint system when this is feasible.

When seat positioning options are fitted the following should be followed unless necessary for postural or medical requirements of the occupant.

**Seat elevator:** fully DOWN i.e. the seat at its lowest

**Seat Tilt:** Fully DOWN i.e. the seat parallel to the ground

**Legrest:** Fully DOWN i.e. feet close to the floor, knees bent at 90°

**Backrest:** Upright i.e. at or close to 90° to the seat

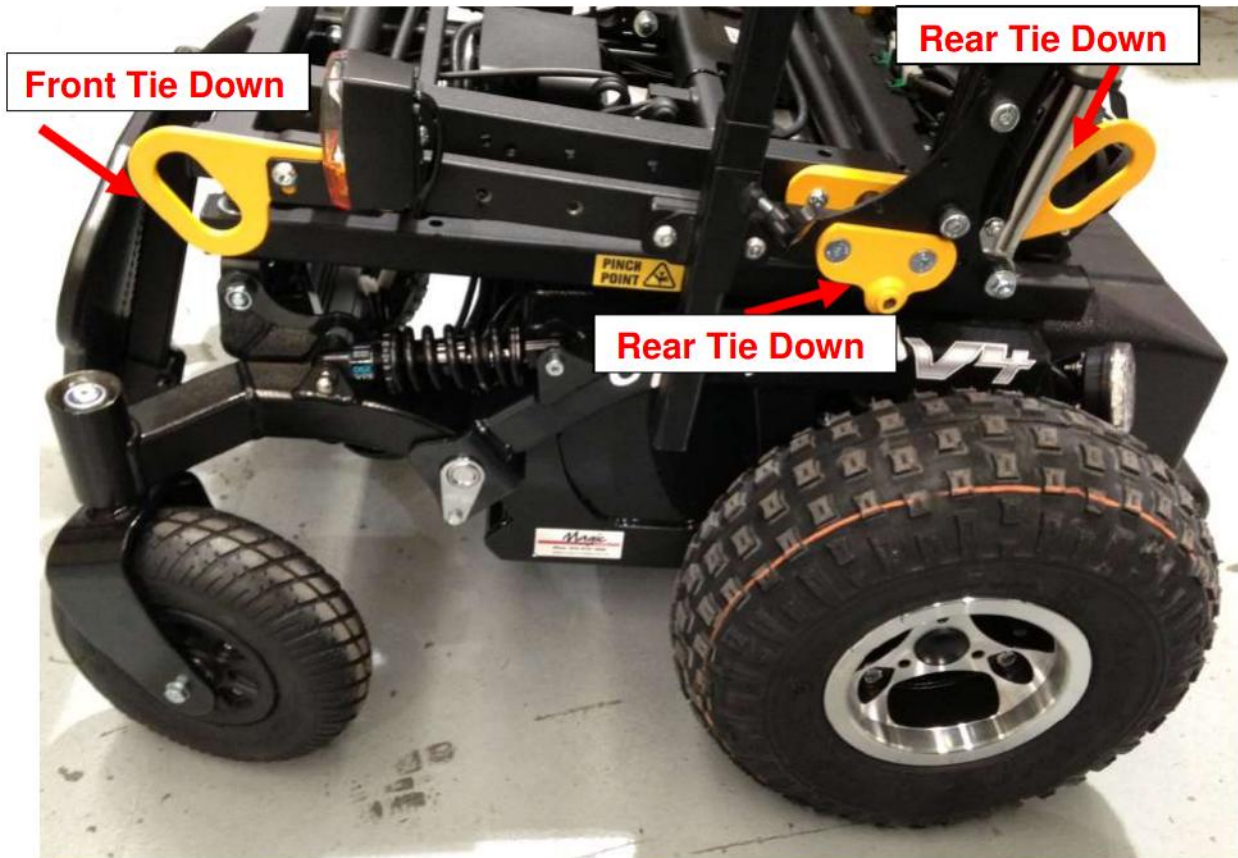

Figure 1 - V6 Tie Down Locations

There are four wheelchair securement points; two at the front and two at the rear.

The tie downs have a rectangular aperture 25mm x 50mm. Any hook or loop of the restraint end fitting must fit through this hole.

The wheelchair provides for anchoring a pelvic belt restraint that conforms to the requirements requirements of RESNA WC19 Section 19 and ISO7176-19. The belt anchor points are shown in shown in

Figure 1. The seatbelt is anchored over a 14mm spigot by an M8 (minimum grade 8.8) bolt. The pelvic belt restraint can be used in conjunction with a vehicle anchored shoulder belt with a standard lower anchorage connector as a crashworthy three point belt restraint in motor vehicles.

Magic Mobility supply either a 600mm or 700mm compatible crashworthy wheelchair anchored pelvic belt restraint when WC4;19/ISO7176;19 tie downs are requested. This belt is designed to accommodate use on either side of the vehicle. The belt is equipped with standard interconnect hardware to enable attachment of suitably equipped vehicle anchored shoulder belts. See Figure 2. The free end of the vehicle anchored shoulder belt is installed over the shoulder belt connection pin.

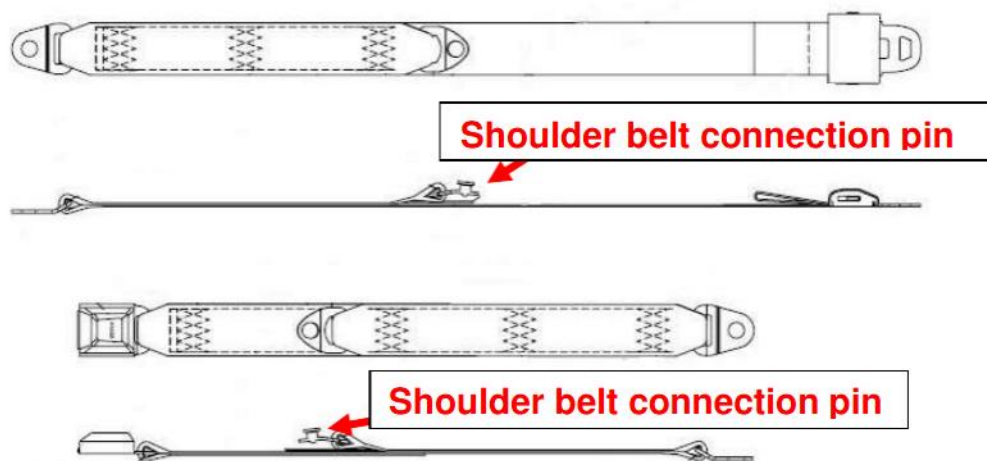

**Figure 2 - The Wheelchair Anchored Pelvic Belt**

The pelvic belt should be worn low across the front of the pelvis and in contact with the tops of the thighs near the thigh-abdominal junctions.

The angle of the pelvic belt restraint should be between 30° to 75° relative to the horizontal and, ideally between within 45° and 75° to the horizontal, as shown in Figure 3

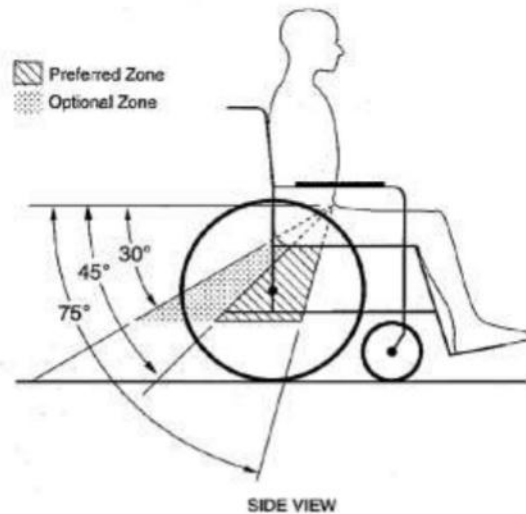

**Figure 3 - Preferred and optimal zones for angles of pelvic belt restraints**

The belt restraint buckle of three point belt restraints must be placed in contact with the occupant's body and away from wheelchair components

Upper torso belt restraints should fit directly over, and in contact with, the middle of the shoulder.

The junction of the shoulder belt and pelvic belt of three point belts should be located near the hip opposite to the shoulder over which the diagonal belt crosses and not near the midline of the occupant

Belt restraints should not be routed outside of the wheelchair wheels or over the wheelchair arm supports and should not be held away from the body by the wheelchair components or parts, such as the wheelchair armrests or wheels, see Figure 4 and Figure 5.



**Figure 4 - Illustration of improper positioning of belt restraints**

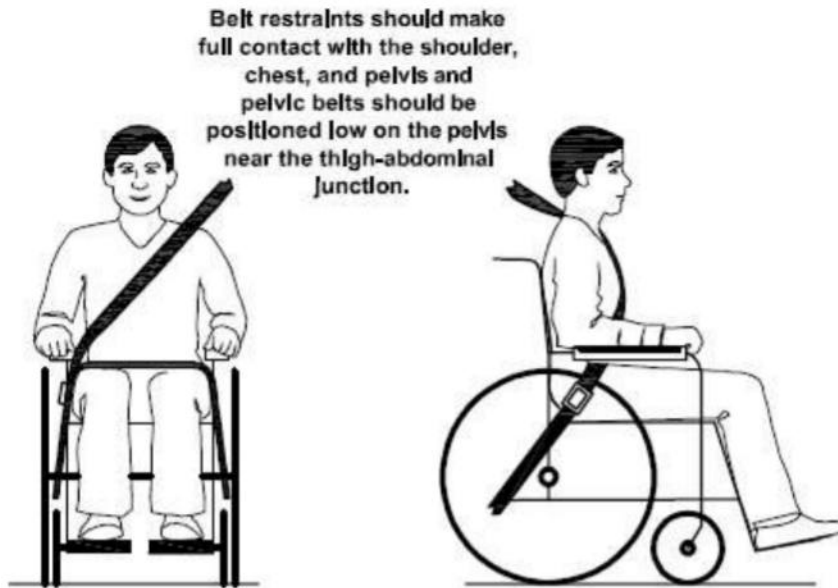





**Figure 5 - Illustration of proper routing and positioning of belt restraints on the wheelchair occupant**

Belt restraints should be adjusted as snugly as possible, consistent with user comfort. Belt restraints should not be worn or twisted in a manner that reduces the area of contact of the belt webbing with the occupant

This wheelchair has the following ratings if WC4-19/ISO7176-19 tie downs are fitted

Ease of proper belt positioning: Excellent  
 Extent to which proper belt fit is achieved: Excellent

ISO7176-19 states that a mid size adult male weighs between 75 and 136Kgs and the appropriate ATD (crash test dummy) would weigh approximately 76Kg. This wheelchair was tested with a 76Kg ATD. Occupants with a higher weight are at increased risk during an accident and a weight over 136Kgs is outside the scope of the testing conducted.

  <b>WARNINGS</b>  
<p><b>The wheelchair is designed specifically for forward facing use in motor vehicles</b></p>
<p><b>The wheelchair should only be used in motor vehicles as described in the wheelchair manufacturer's instructions</b></p>
<p><b>The wheelchair has been dynamically tested in a forward facing mode when loaded with a crash test dummy restrained with pelvic and shoulder belts. Both pelvic and upper torso belts designed for use as crashworthy restraints</b></p>

**in motor vehicles should be used to reduce the risk of serious injuries to wheelchair occupants**

**Alterations or substitutions should not be made to the wheelchair or seating system structural members, or to its parts and components, without consulting the wheelchair manufacturer**

**The use of postural pelvic belts attached to the wheelchair base or seat frame is encouraged during travel, but these belts should be positioned so they don't interfere with the proper positioning of crashworthy belt restraints and should not be relied on for occupant protection in crash situations unless the postural belt has been designed to comply with, and perform to, requirements of RESNA WC4, Section 19 and ISO 7176, Section 19**

**Both pelvic and shoulder belt restraints that comply with RESNA WC4, Section 19 and ISO 7176, Section 19 should be used to limit occupant movement in a crash and reduce the likelihood of injury**

**Belt restraints should be positioned on wheelchair occupants in accordance with the wheelchair tie down and occupant restraint system and the manufacturer's instructions**

**Whenever possible, auxiliary wheelchair equipment should be removed from the wheelchair and stored in a cargo area or secured in the vehicle during transit, or effectively secured to the wheelchair so that it does not break loose and cause injury to vehicle occupants in a crash**

**Rigid trays on wheelchairs that are not specifically designed for use during travel in motor vehicles should be either removed and stored separately in the vehicle or be secured to the wheelchair so it will not break free in a crash. Additionally, the tray should be positioned with a gap of at least 75mm(3 in.) between the tray and the wheelchair occupant's abdomen and/or chest so as not to interfere with proper belt restraint use and have energy absorbing padding placed in the gap between the tray edge and the wheelchair occupant**

**The wheelchair manufacturer should be consulted for questions about using the wheelchair for seating in a motor vehicle,**

**Sufficient forward and rearward clear space should be provided around the wheelchair occupant as shown in Figure 14.**

**The forward clear space zone (FCZ) needs to be larger when a shoulder belt restraint is not used**

Dimensions in millimeters

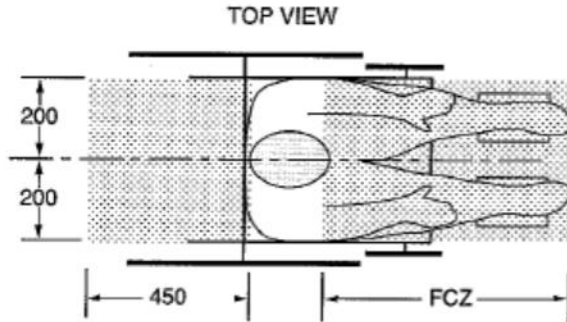

NOTES: The rear clear zone is measured from the rearmost point on an occupant's head. The front clear zone is measured from the frontmost point on an occupant's head.

Seated head height (HHT) ranges from about 1200 mm for a small adult female to about 1550 mm for a tall adult male.

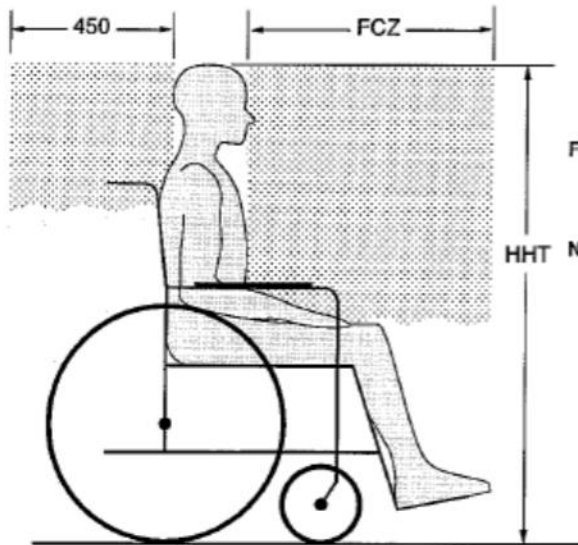

FCZ = 650 mm with upper torso restraint  
= 950 mm with only pelvic restraint

NOTE: It is strongly recommended that both pelvic and upper-torso belts be used.

SIDE VIEW

NOTE The frontal clear zone may not be achievable for wheelchair-seated drivers.

**Vehicle interior components that cannot be removed from the clear zones of Error! Reference source not found., or that are near the wheelchair occupant space at a level that may be contacted by a wheelchair occupant's head during a side impact collision or a vehicle rollover, should be padded with material that complies to FMVSS 201.**

**Only spill proof batteries (e.g. gel-cell) should be installed on wheelchairs that are transported in motor vehicles.**

**Back supports with adjustable recline angles should not be reclined to more than 30° to the vertical during vehicle travel unless necessary for the postural and medical needs of the occupant**

**For people who use heavy wheelchairs transportation in larger vehicles is recommended when the option exists**

**The wheelchair should be inspected by a manufacturer's representative before reuse following involvement in any type of collision**

**Care should be taken when applying the occupant restraint to position the seatbelt buckle so that the release button will not be contacted by wheelchair components during a crash**

## Appendix B – Electromagnetic Interference (EMI)

### Electromagnetic Interference (EMI) From Radio Wave Sources

Powered Wheelchairs may be susceptible to electromagnetic interference (EMI), which is interfering electromagnetic energy (EM) emitted from sources such as radio stations, TV stations, amateur radio (HAM) transmitters, two-way radios and cellular phones. The interference (from radio wave sources) can cause the powered wheelchair to release its brakes, move by itself, or move in unintended directions. It can also permanently damage the powered wheelchair's control system. The intensity of the interfering EM energy can be measured in volts per meter (V/m). Each powered wheelchair can resist EMI up to a certain intensity. This is called its "immunity level" The higher the immunity level, the greater the protection. At this time, current technology is capable of achieving at least a 20 V/m immunity level, which would provide useful protection from the more common sources of radiated EMI. This powered wheelchair model as shipped, with no further modification, has an unknown immunity. There are a number of sources of relatively intense electromagnetic fields in the everyday environment. Some of these sources are obvious and easy to avoid. Others are not apparent and exposure is unavoidable. However, we believe that by following the warnings listed below, your risk to EMI will be minimised.

The sources of radiated EMI can be broadly classified into three types:

1) Hand held portable transceivers (transmitters-receivers) with the antenna mounted directly on the transmitting unit. Examples include: citizens band (CB) radios, "walkie talkie," security, fire and police transceivers, cellular telephones, and other personal communication devices. \*\*NOTE: Some cellular telephones and similar devices transmit signals while they are ON, even when not being used;

2) Medium-range mobile transceivers, such as those used in police cars, fire trucks, ambulance, and taxis. These usually have the antenna mounted on the outside of the vehicle; and

3) Long range transmitters and transceivers, such as commercial broadcast transmitters (radio and TV broadcast antenna towers) and amateur (HAM) radios.

NOTE: Other types of hand-held devices, such as cordless phones, laptop computers, AM/FM radios, TV sets, CD players, and small appliances such as electric shavers and hair dryers, so far as we know are not likely to cause EMI problems to your powered wheelchair.

### Powered Wheelchair Electromagnetic Interference (EMI)

Because EM energy rapidly becomes more intense as one moves closer to the transmitting antenna (source), the EM fields from hand-held radio wave sources (transceivers) are of special concern. It is possible to unintentionally bring high levels of EM energy very close to the powered wheelchair's control system while using these devices. This can affect powered wheelchair movement and braking. Therefore, the warnings listed below are recommended to prevent possible interference with the control system of the powered wheelchair.

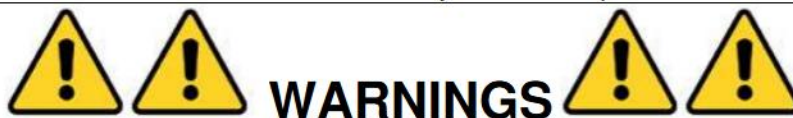

Electromagnetic interference (EMI) from sources such as radio and TV stations, amateur radio (HAM) transmitters, two way radios and cellular phones can affect powered wheelchairs.

Following the warnings listed below should reduce the chance of unintended brake release

or powered wheelchair movement which could result in serious injury.
Do not operate hand held transceivers (transmitter-receivers), such as citizens band (CB) radios, or turn ON personal communication devices, such as cellular phones, while the powered wheelchair is turned ON.
Be aware of nearby transmitters, such as radio or TV stations, and try to avoid coming close to them.
If unintended movement or brake release occurs, turn the powered wheelchair OFF as soon as it is safe to do so.
Be aware that adding accessories or components, or modifying the powered wheelchair, may make it more susceptible to EMI (Note: There is no easy way to evaluate their effect on the overall immunity of the powered wheelchair)
Report all incidents of unintended movement or brake release to the powered wheelchair manufacturer, and note whether there is a source of EMI nearby.

### **Important Information**

1) 20 volts per meter (V/m) is a generally achievable and useful immunity level against EMI (as of May 1994) (the higher the level the greater the protection)

2) This product has an unknown immunity.

United States of America (ONLY)

Caution: Federal law restricts this device to sale by or on the order of a practitioner licensed by the law of the State in which he/she practices.