



--	--

--	--

--	--

--	--

--

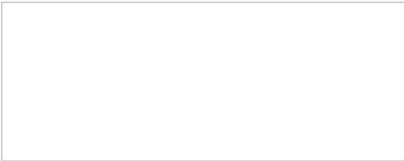

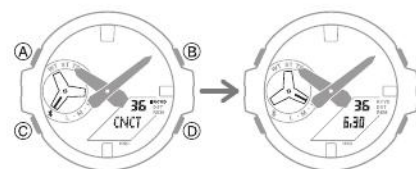

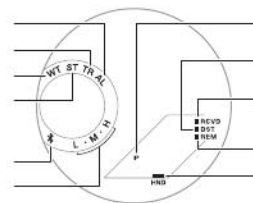
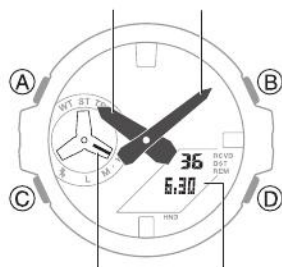

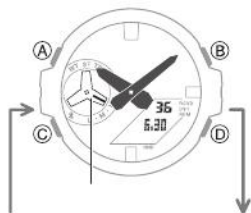

ALM → AL1



WT → NYC: NEW YORK



TMR



STW → SPL

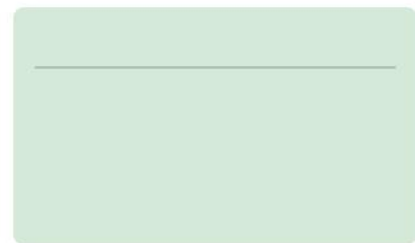
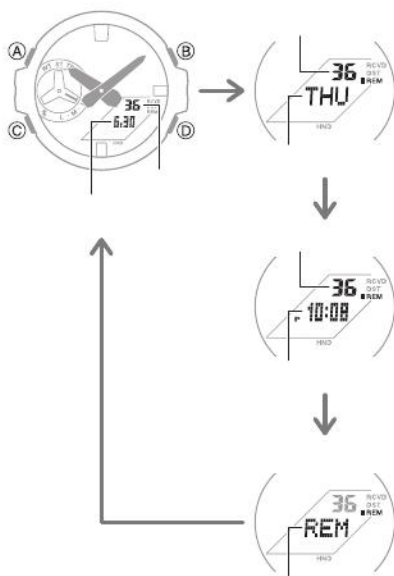
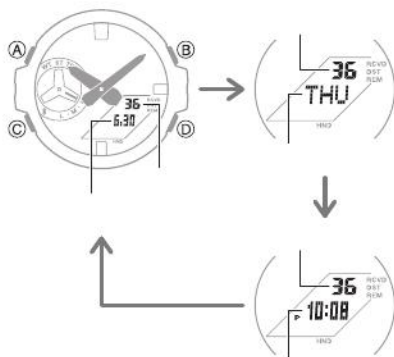
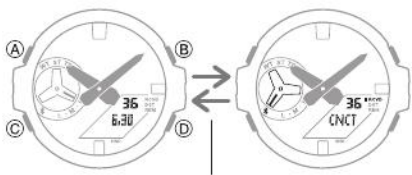

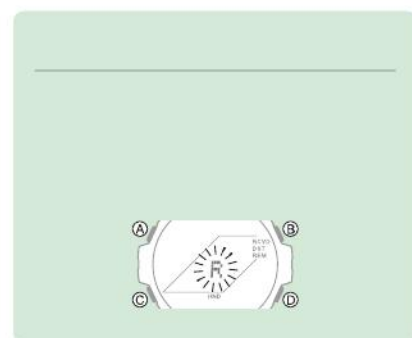
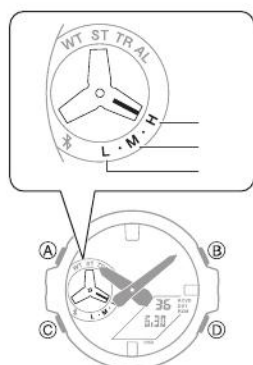
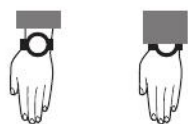

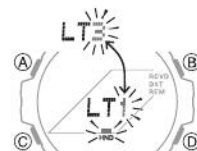
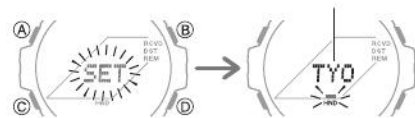

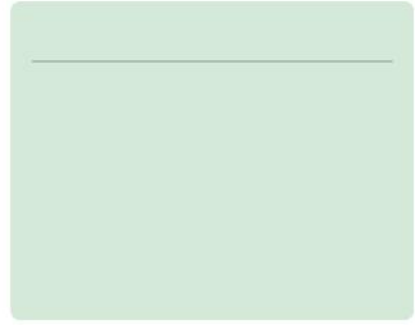
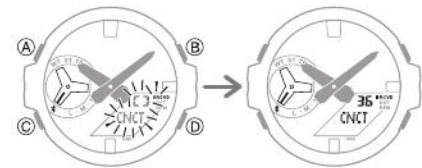
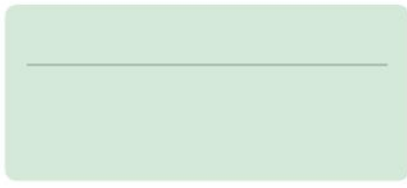
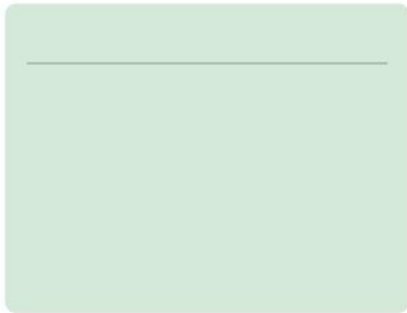
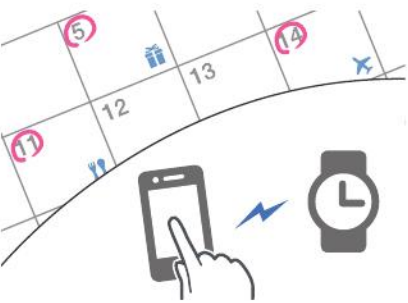

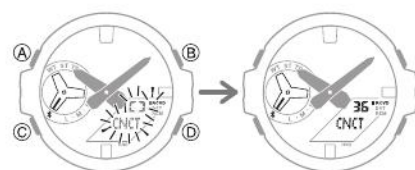
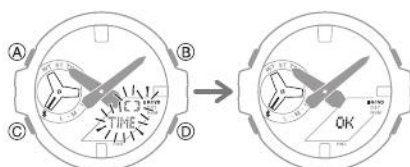

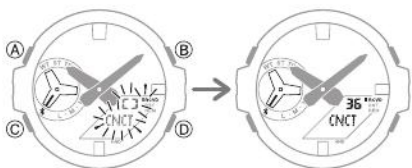
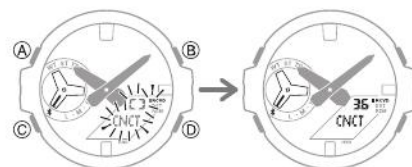
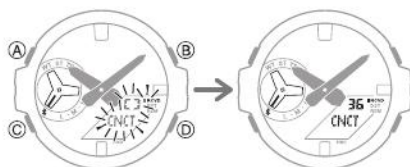

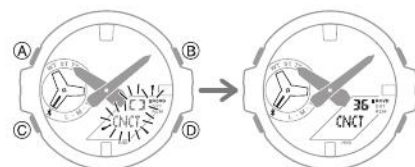
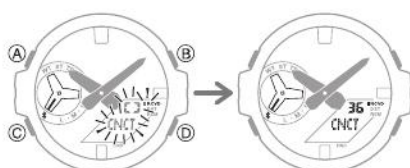
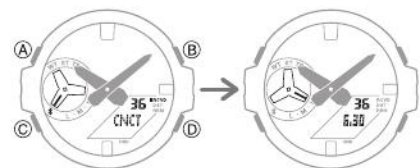
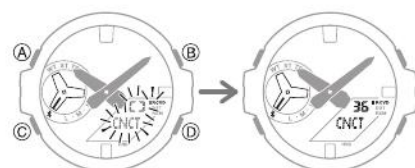
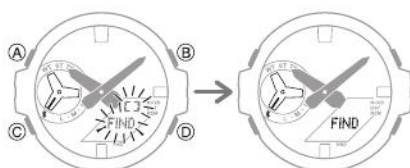
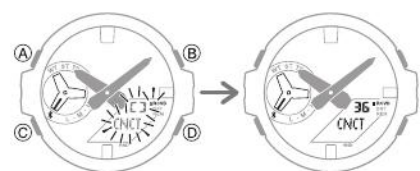



I

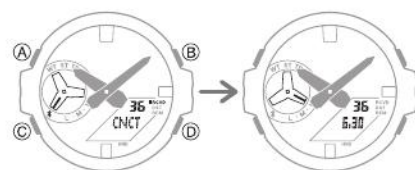

I

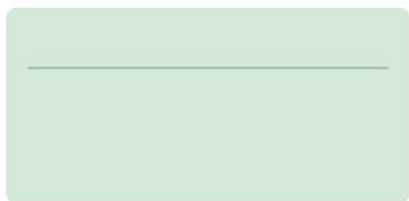
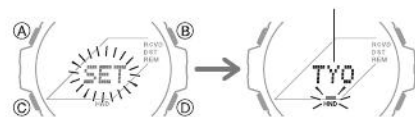
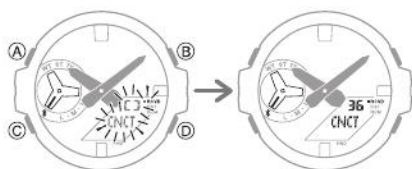

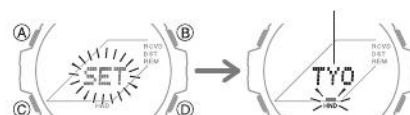
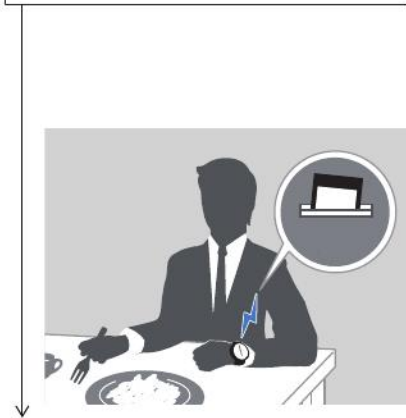
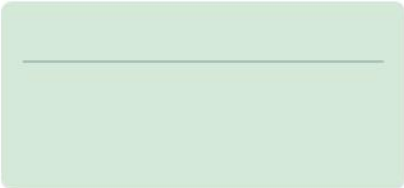
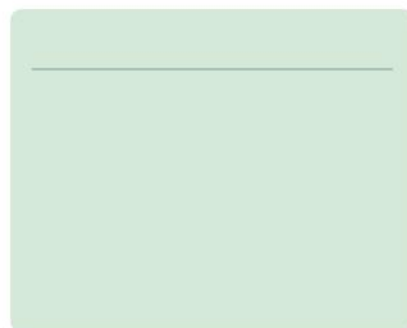



A vertical sequence of 15 empty rectangular boxes for data entry. To the left of the boxes is a long vertical arrow pointing upwards. Between each box is a downward-pointing arrow, indicating a sequence from top to bottom.

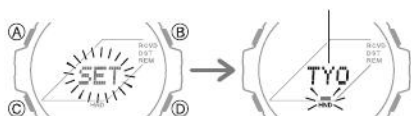
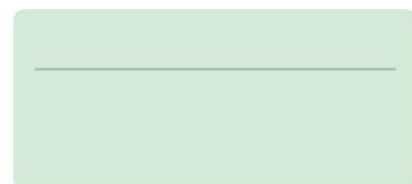

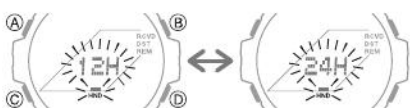
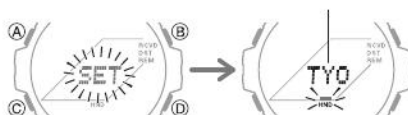
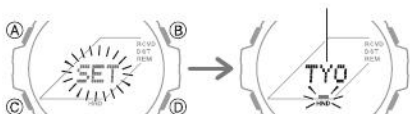
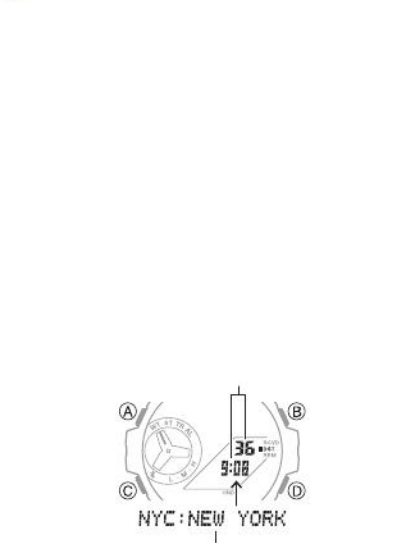
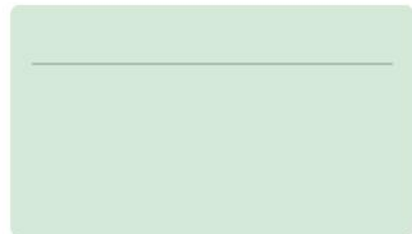

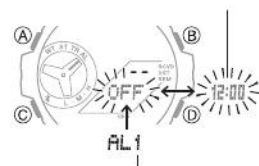
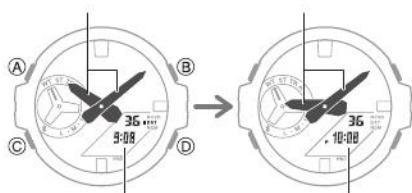

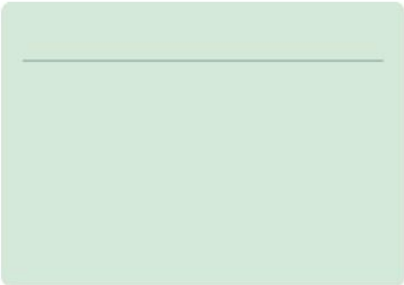
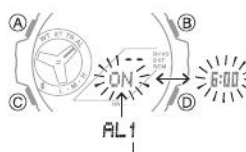
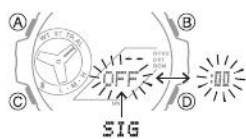

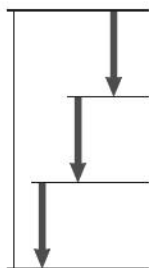
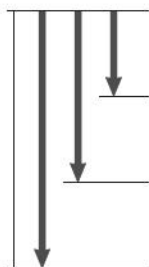
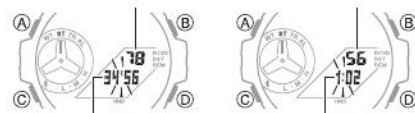
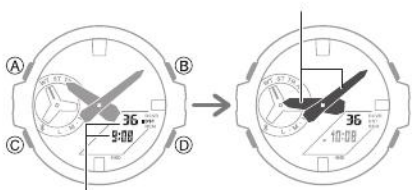

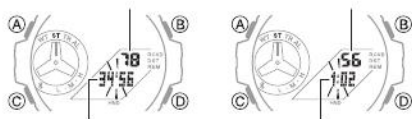
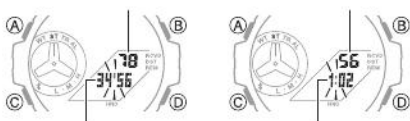

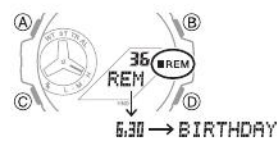
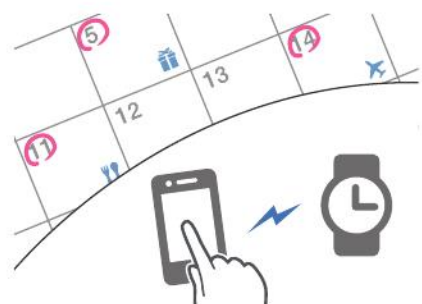
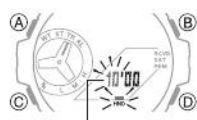

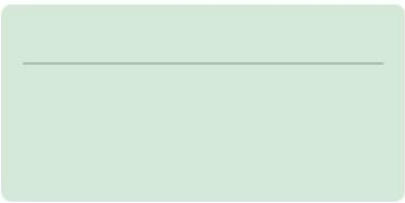
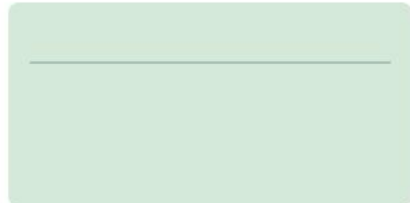
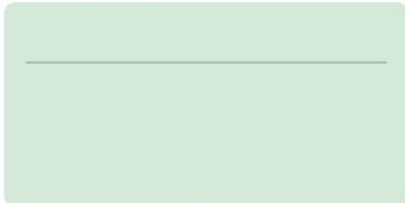
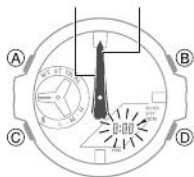
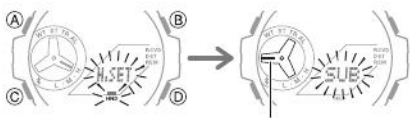
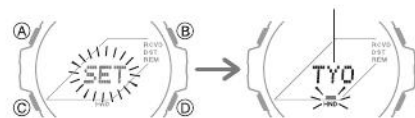
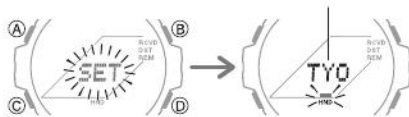

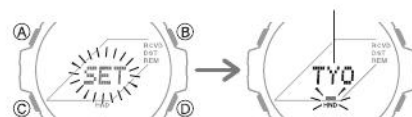
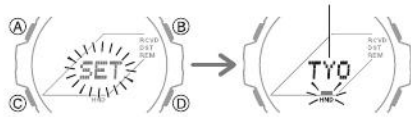
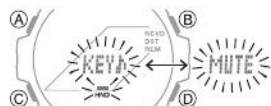
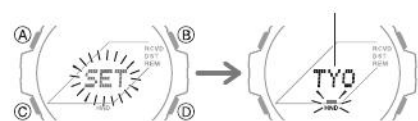

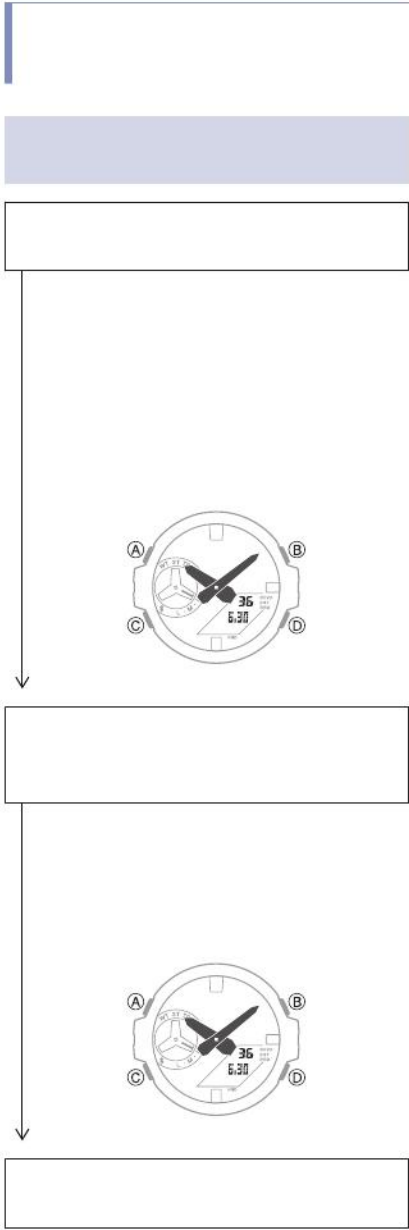
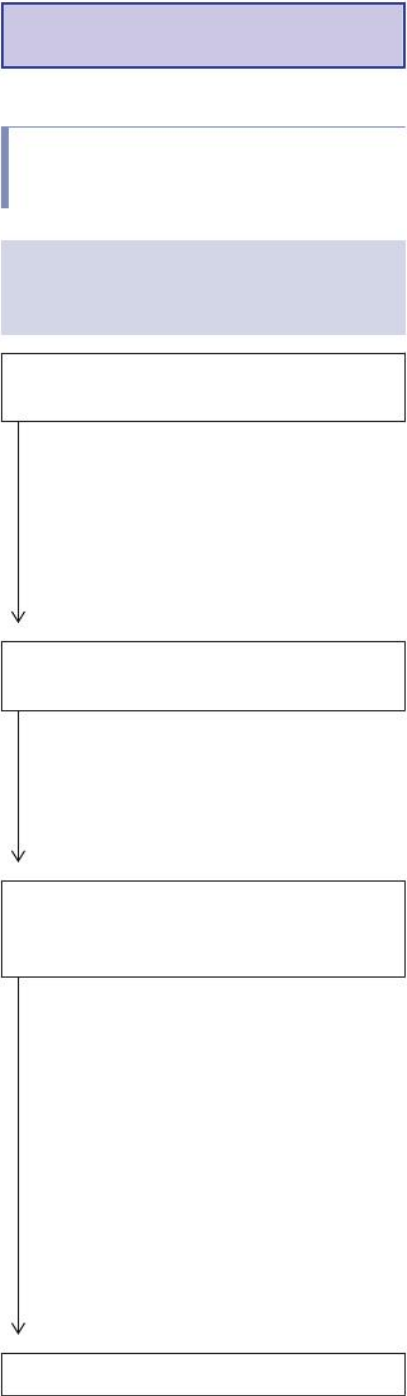



[Blank box]

[Shaded box]

[Blank box]

↓



[Blank box]

↓

[Blank box]

[Blank box]

[Shaded box]

[Blank box]

[Shaded box]

[Blank box]

↓

[Blank box]

[Blank box]

[Shaded box]

[Blank box]

↓

[Blank box]

[Shaded box]

[Blank box]

↓

[Blank box]

[Blank box]

[Shaded box]

[Shaded box]

[Blank box]

[Shaded box]

[Blank box]

[Shaded box]

[Blank box]



[Shaded box]

