

\_\_\_\_\_

\_\_\_\_\_

\_\_\_\_\_

\_\_\_\_\_



\_\_\_\_\_

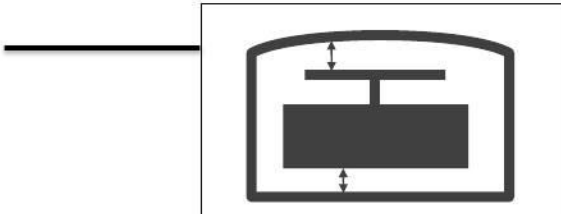

\_\_\_\_\_

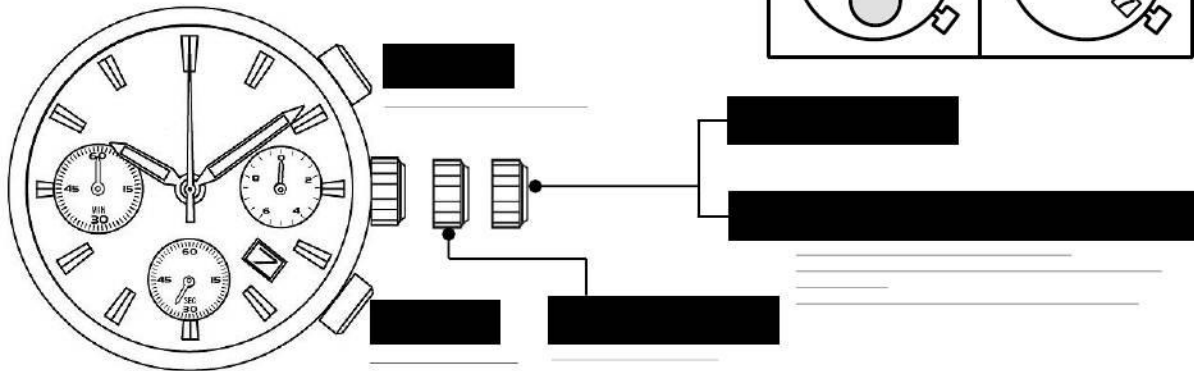
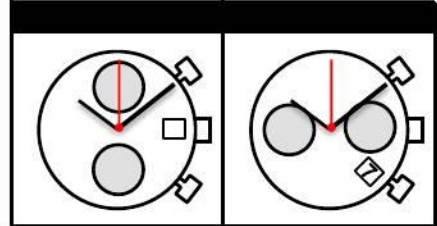
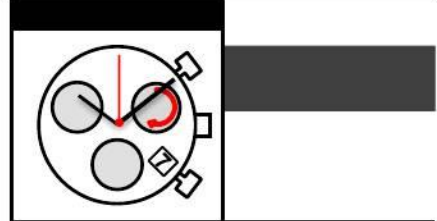
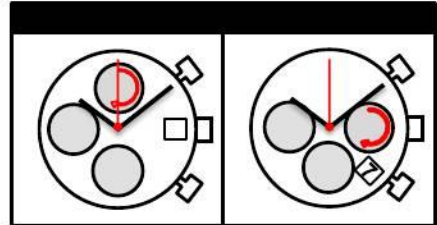
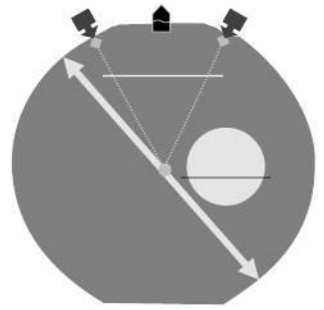

2011/12/12 (14.09.16)

This drawing is provisional and subject to our reconfirmation and/or revision without notice.

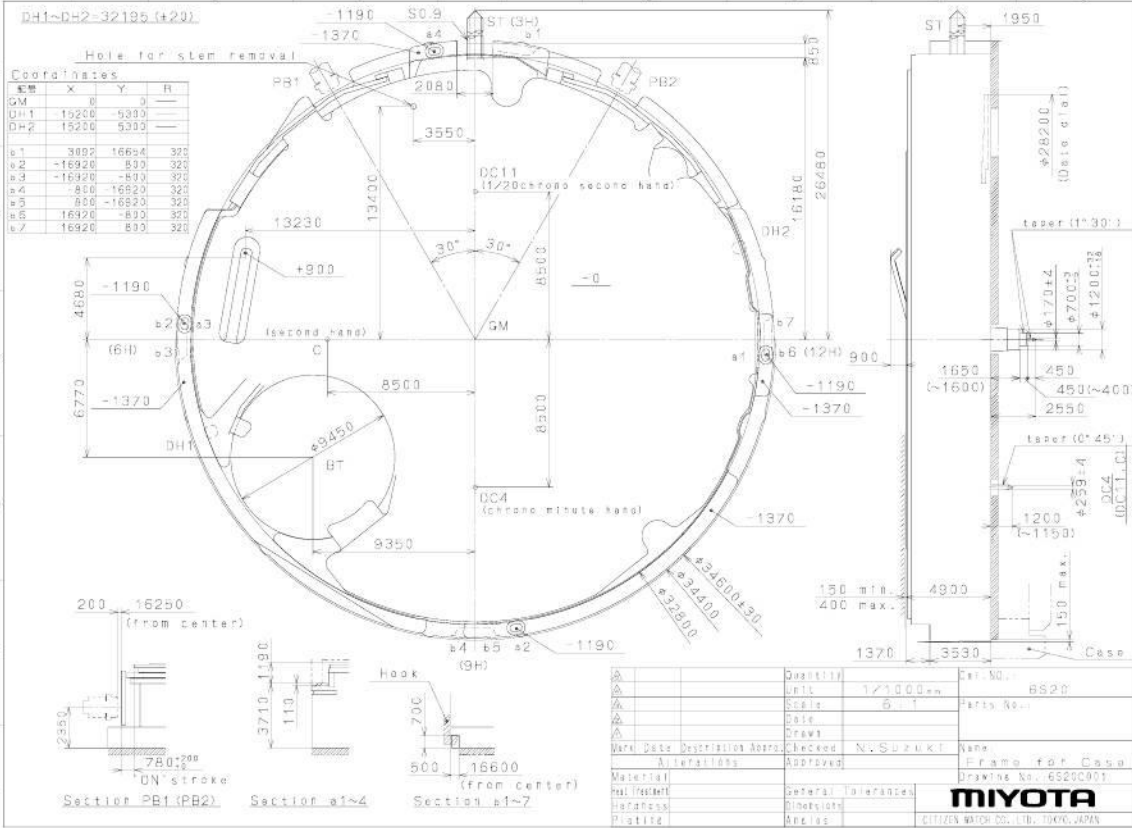

Hole for stem removal

Coordinates			
座標	X	Y	R
GM	0	0	—
DH1	15200	-9300	—
DH2	15200	9300	—
a1	3892	16624	320
a2	-16920	800	320
a3	-16920	-800	320
a4	800	16620	320
a5	800	-16620	320
a6	16920	-800	320
a7	16920	800	320

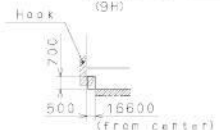
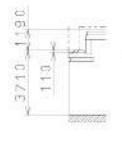

Quantity	Unit	1/1000mm	Part No.	6520
Scale	Scale	5:1	Parts No.	
Date	Date			
Draws	Draws			
Material	Material	Aluminum	Checked	N. SUZUKI
Part Name	Part Name	Frame for Case	Approved	
Finishing	Finishing		Name	
Plating	Plating		Drawing No.	6520C001
General Tolerances			<b>MIYOTA</b> CITIZEN WATCH CO., LTD. TOKYO, JAPAN	
Diameters				
Angles				

2010/05/24 (09:03:47)

This drawing is provisional and subject to our reconfirmation and/or revision without notice.

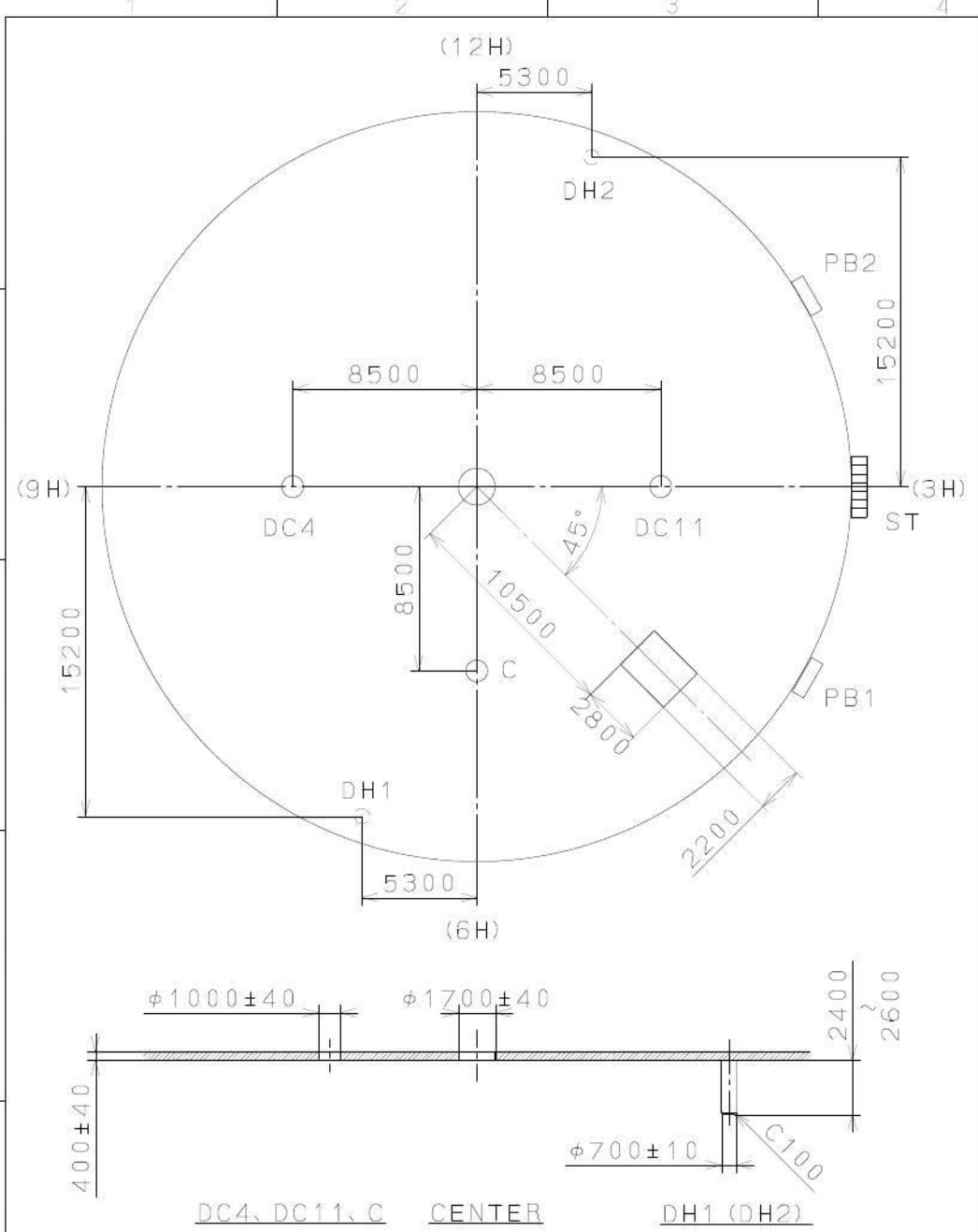

△			Quantity		Cal. NO.:
△			Unit	1/1000mm	6S20-00A
△			Scale	4:1	Parts No.:
△			Date		
△			Drawn		
Material			Checked	N. Suzuki	Name:
Heat Treatment			Alterations	Approved	Indications for Dial
Hardness					Drawing No.:6S200000
Plating			General Tolerances		<b>MIYOTA</b>
			Dimensions		
			Angles		
					CITIZEN WATCH CO., LTD., TOKYO, JAPAN

2010/07/26 (09:03:08)

This drawing is provisional and subject to our reconfirmation and/or revision without notice.

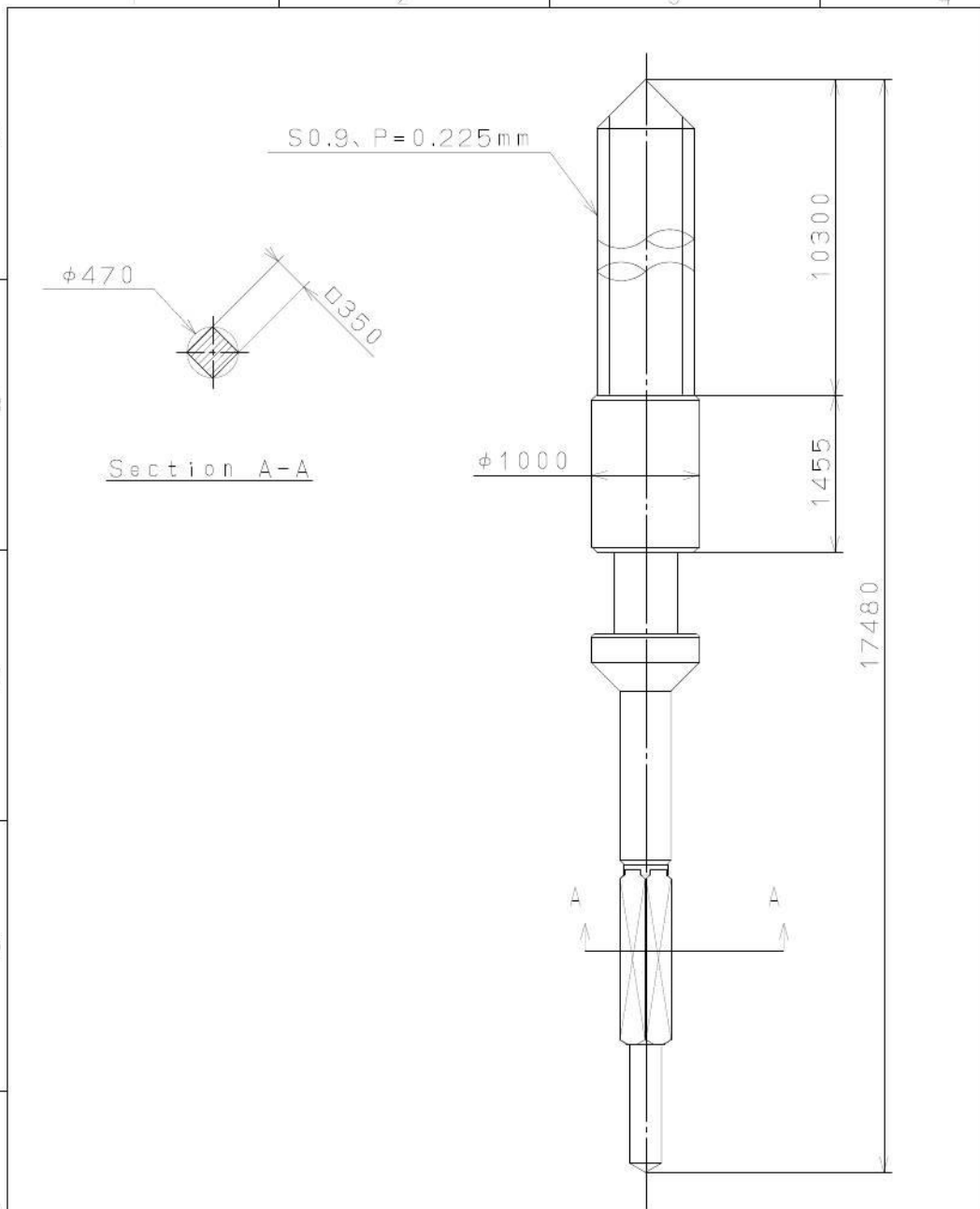

△			Quantity		Cal. NO.:
△			Unit	1/1000mm	
△			Scale	20:1	Parts No.:
△			Date		065-A13
△			Drawn		
	Matl.	Date	Description	Appr. Checked	Name:
			Alterations	Approved	SETTING STEM
	Material				Drawing No.: A130S000
F	Heat Treatment		General Tolerances	<b>MIYOTA</b> CITIZEN WATCH CO., LTD., TOKYO, JAPAN	
	Hardness		Dimensions		
	Plating		Angles		



# MIYOTA

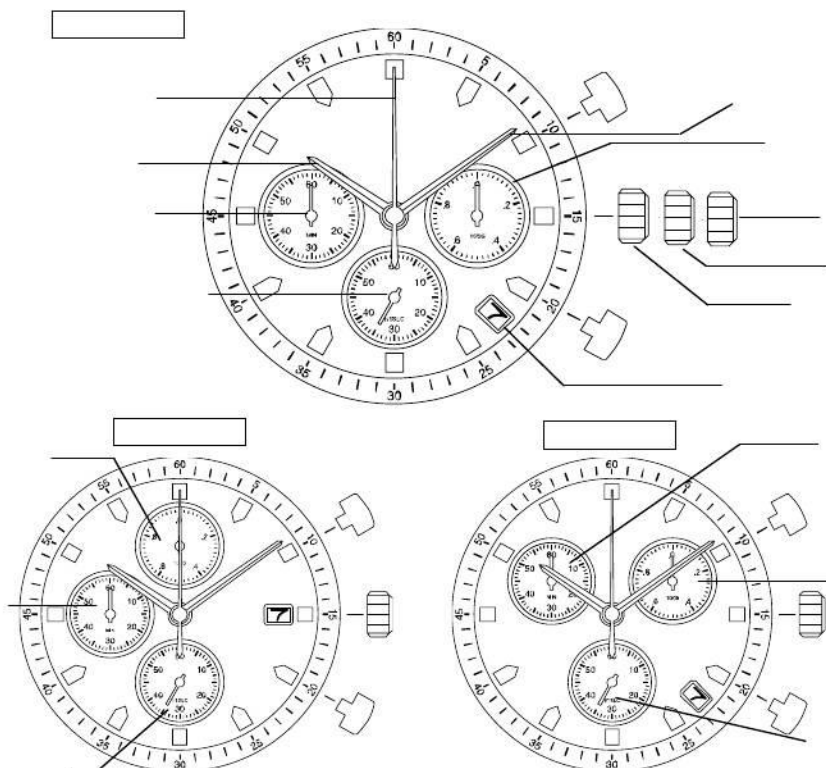

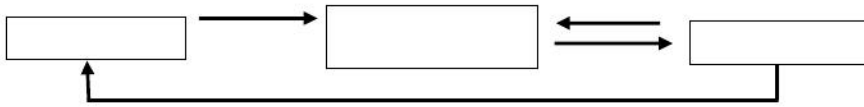

**CITIZEN WATCH CO., LTD.**

# MIYOTA

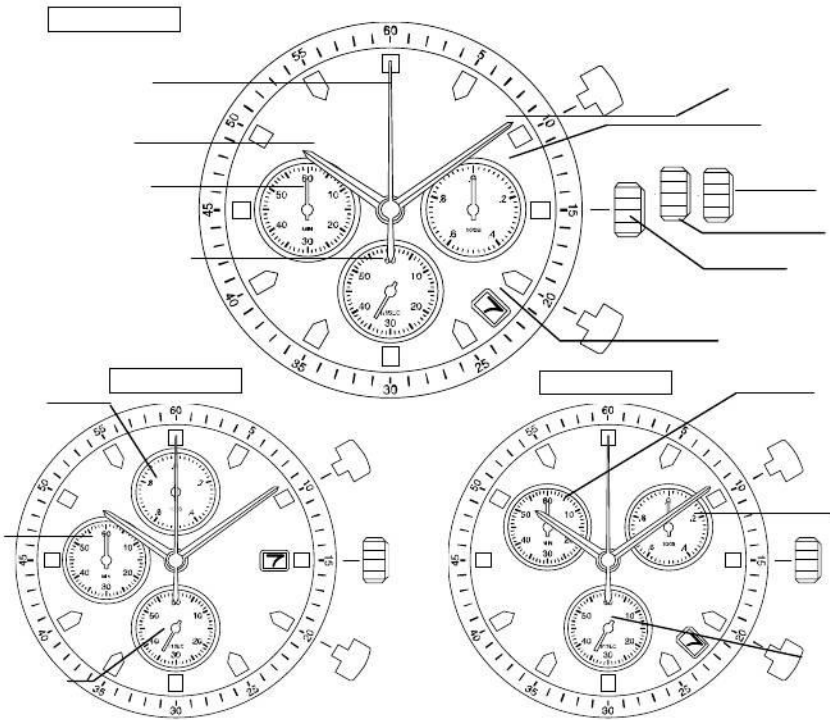

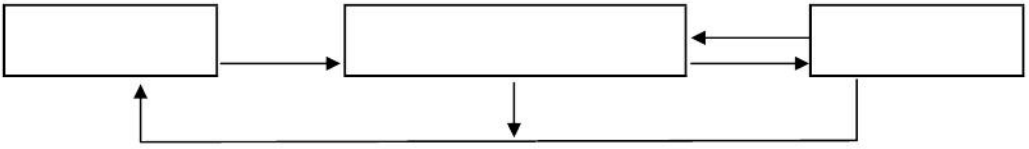

**CITIZEN WATCH CO., LTD.**

# MIYOTA

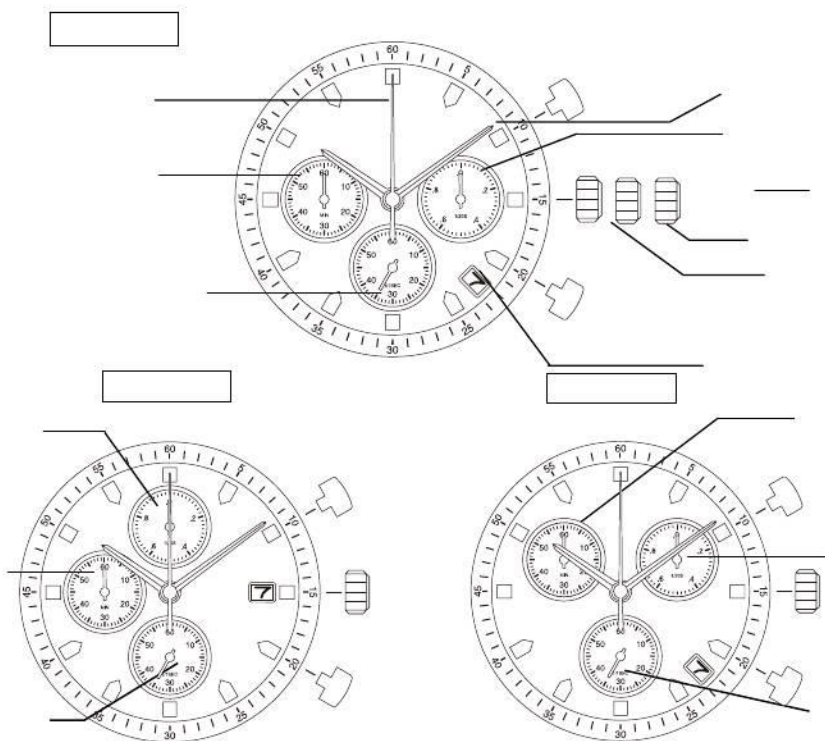

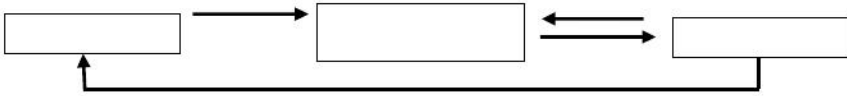

**CITIZEN WATCH CO., LTD.**

# MIYOTA

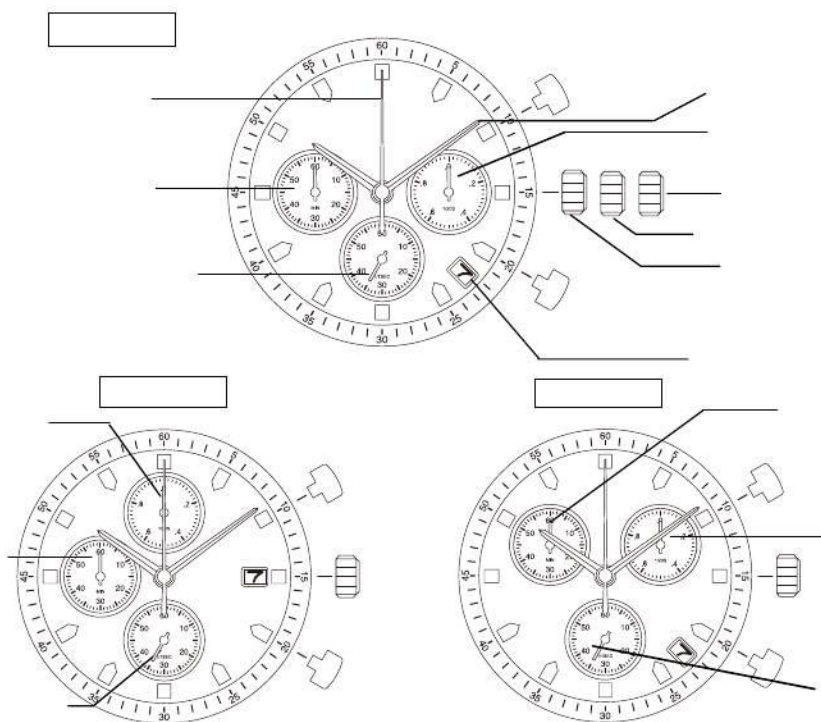

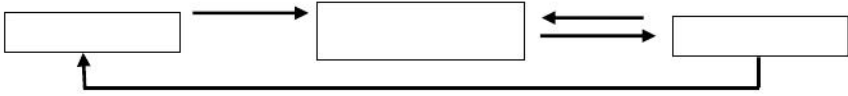

**CITIZEN WATCH CO., LTD.**

# MIYOTA

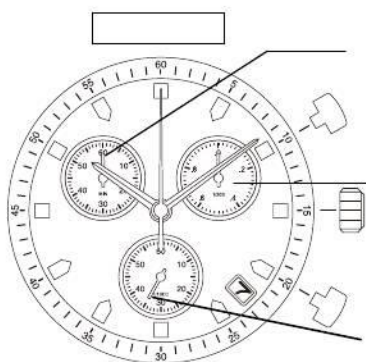
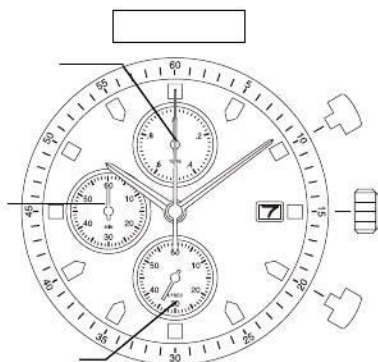
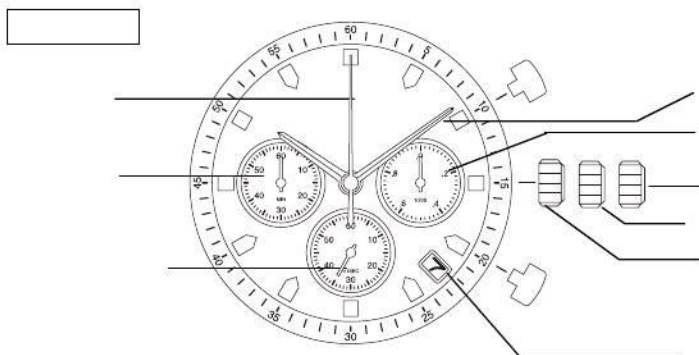



**CITIZEN WATCH CO., LTD.**

# MIYOTA

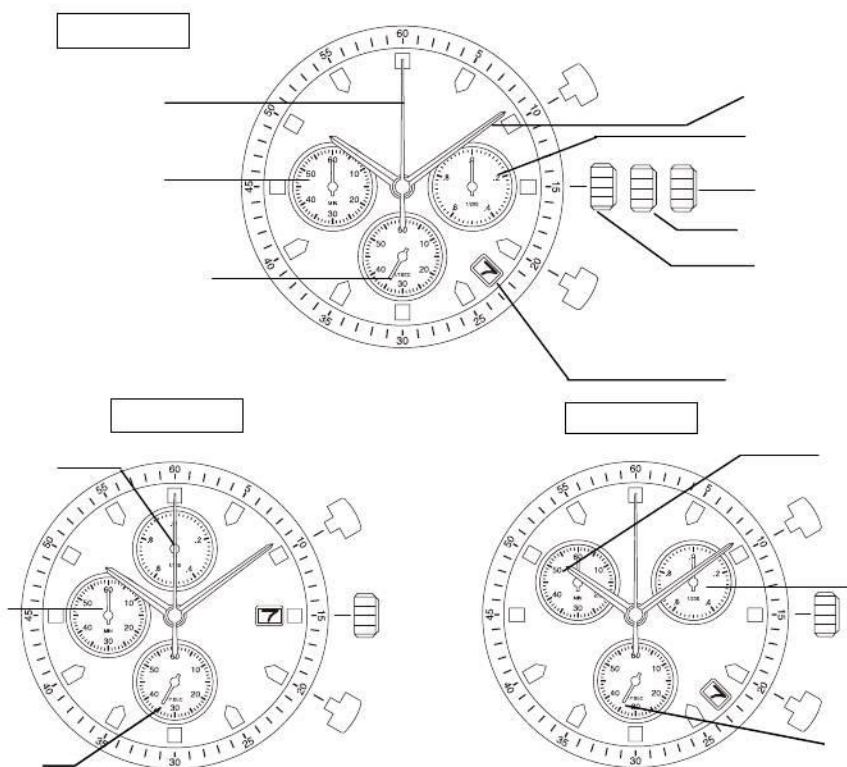

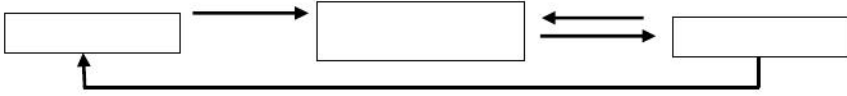

**CITIZEN WATCH CO., LTD.**

# MIYOTA

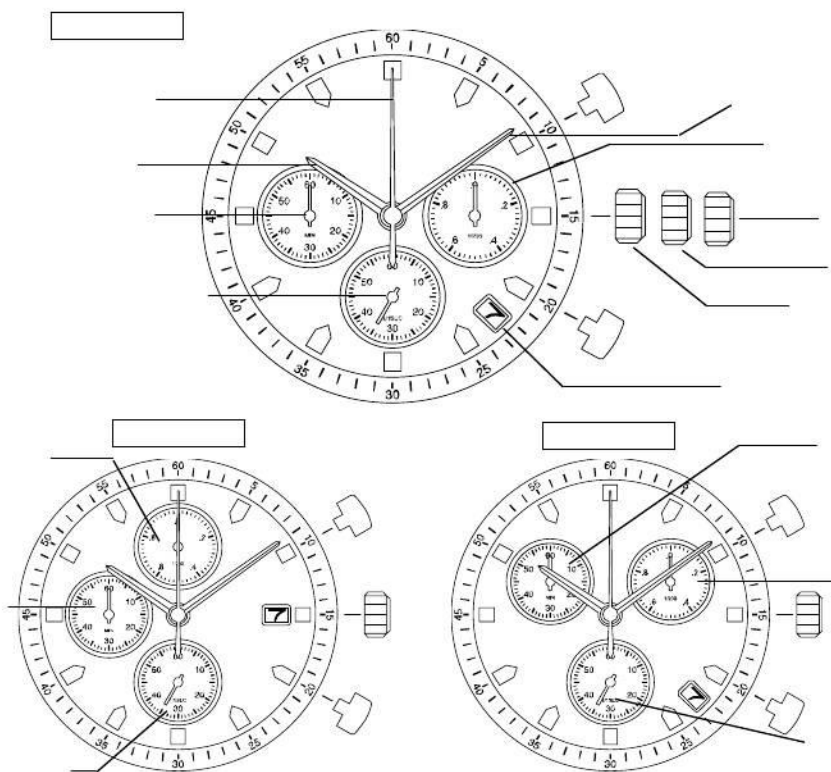

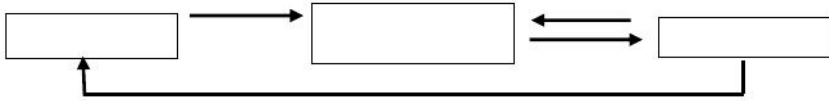

**CITIZEN WATCH CO., LTD.**