

**SEIKO**  
SINCE 1881



SEIKO

ASTRON



GPS<sup>®</sup>  
SOLAR





---

---



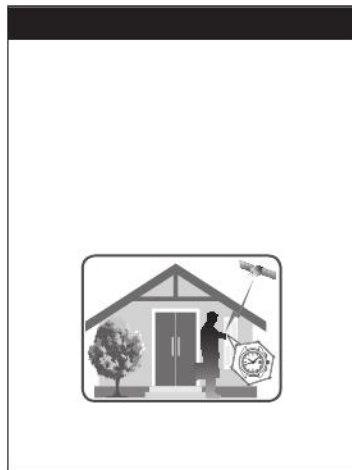
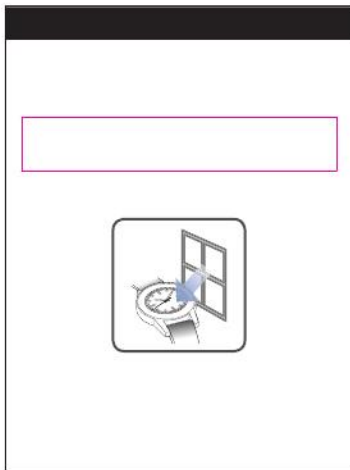
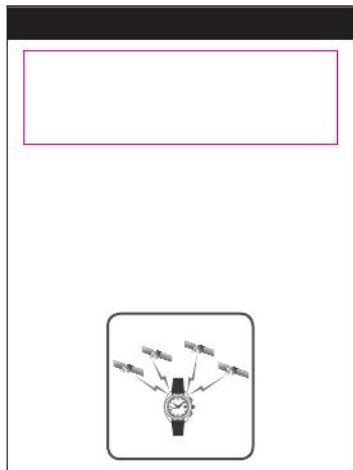





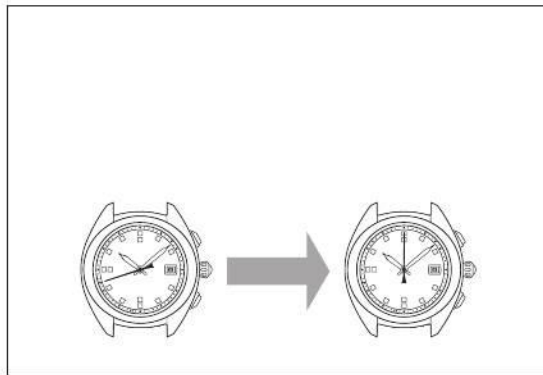
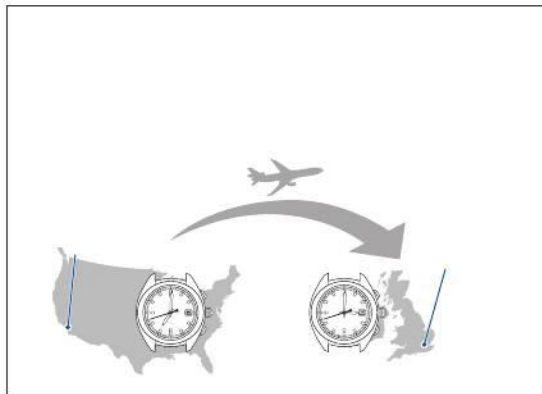

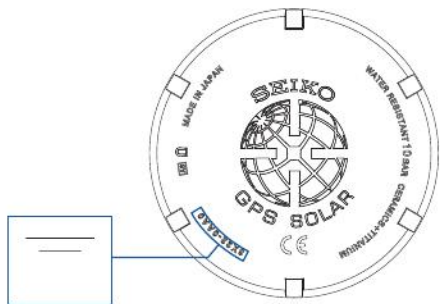

✕

✕

### Names of the parts

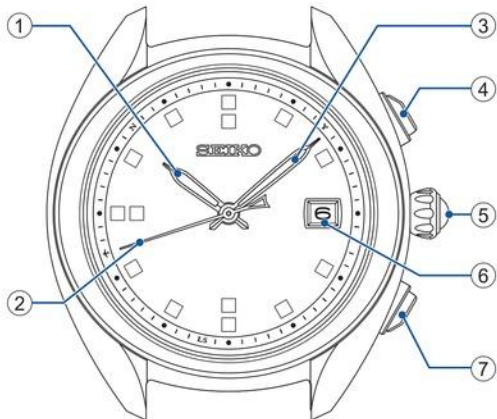

- ① Hour hand
- ② Seconds hand
- ③ Minute hand
- ④ Button A
- ⑤ Crown
- ⑥ Date
- ⑦ Button B

\* The orientation and design of the display may vary depending on the model.

## About display of reception results and in-flight mode ( ✕ )

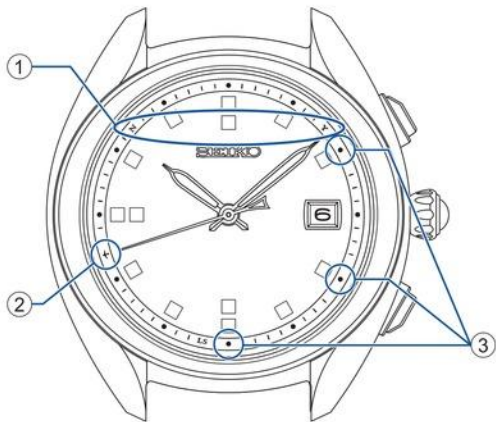

## ① Display of reception result

Y : Reception successful (8-second position)

N : Reception failed (52-second position)

→ Check the reception result P. 18

## ② Display of in-flight mode ( ✕ )

Hand position	In-flight mode ( ✕ ) status
Display	

→ In-flight mode P. 25

## ③ Display of charging status

Hand position	full	middle	low
Display			

→ Check the charging status P. 13



→ How to charge the watch P. 14

\* The orientation and design of the display may vary depending on the model.







○

✕







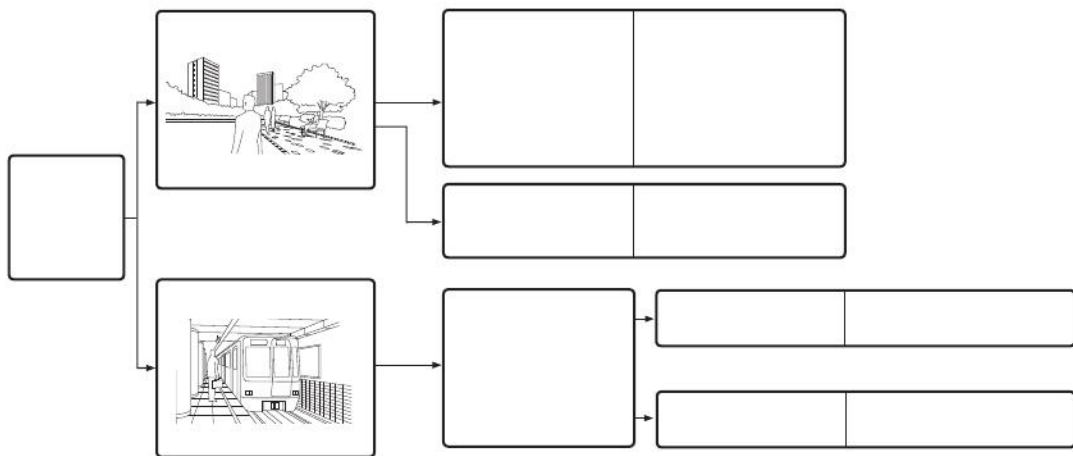

○

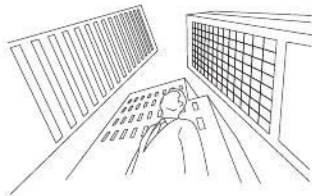

△



x

x

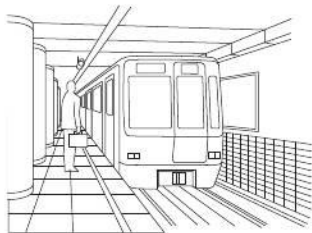



		_____	
		_____	



\_\_\_\_\_



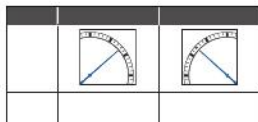

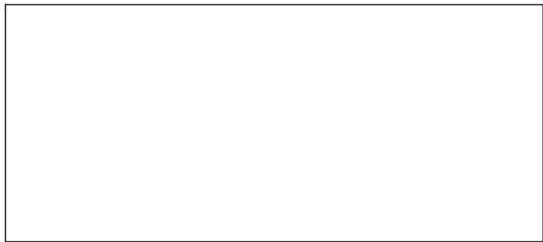





\_\_\_\_\_

---

---





## Setting the destination time zone while in flight, etc. (manual time difference setting), and setting/resetting DST (daylight saving time or "summer time")

### ■ About manual time difference setting (selection)

When time zone adjustment cannot be performed, the time difference can be set (selected) manually.

→ Place where GPS signals can be easily received/Place where GPS signals cannot be received P. 16

Using "List of time differences around the world (for reference)" P. 12 as a guide, the watch can be matched to the time and date of your location by setting the time difference (including the date).

### ■ How to perform manual time difference setting (selection)

#### 1 Pull out the crown to the first click

The seconds hand will move to the 0-second position.



\* When in-flight mode is set, the seconds hand will move to the 42-second position.

#### 2 Turn the crown to set the watch to the time at the destination

Each turn of the crown changes the time in 1-hour increments.

\* Take note of which way you turn the crown.

When the time has been set in 1-hour increments, go to operation 3.



\* To set the watch to the time at the destination, the time and date must be set. If you turn the crown in the wrong direction, change direction and reset the date and time.

\* A date up to about 2 weeks later (or earlier) can be displayed. Note that changing the date too far will result in a date two weeks earlier (or later).

#### 3 Pull out the crown to the second click

When setting the time in 1-hour increments does not set the correct time, continue with setting the time in 15-minute increments.

\* Take note of which way you turn the crown.

\* By making adjustments 4 times, an adjustment of 1 hour can be made.

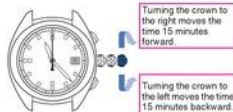

\* When in-flight mode is set, the seconds hand will move to the 0-second position.

#### 4 Push the crown back in

The seconds hand returns to the time display mode.

\* The buttons cannot be operated while the hour, minute, and seconds hands and the date are moving.



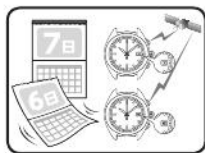

---

x

---

---

## When boarding (in-flight mode (✈))

### ■ In-flight mode (✈)

Set to the in-flight mode (✈) where the reception may influence operation of other electronics devices in an airplane, etc.

In the in-flight mode (✈), the GPS signal reception (time zone adjustment, manual time adjustment, and automatic time adjustment) does not work.

< In-flight mode (✈) >

The mode is displayed when the crown is pulled out to the first click.



### ■ Set to the in-flight mode (✈).

#### 1 Pull out the crown to the first click

The seconds hand will move, and the currently set in-flight mode status (42-second) / reset (0-second) will be displayed.



\* Take note that turning the crown at this time will perform manual time difference setting.

#### 2 Continue to press Button B (3 seconds)

The seconds hand will move to the ✈ (42-second) position.



#### 3 Push the crown back in



→ Setting the destination time zone while in flight, etc. (manual time difference setting), and setting/resetting DST (daylight saving time or "summer time") P. 23

### ■ Reset the in-flight mode (✈).

Turn off the in-flight mode when leaving an airplane, etc.

If it is not turned off, the watch will not be able to receive GPS signals.

Carry out operation **1** to **3**.

In operation **2**, when the seconds hand points to the 0-second position, in-flight mode (✈) is reset.





\* In operation **2**, the seconds hand shows a "0-second position" and you can see that the in-flight mode (✈) has been canceled.

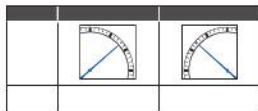
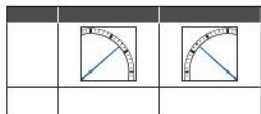









		



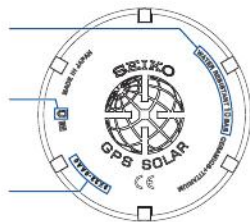

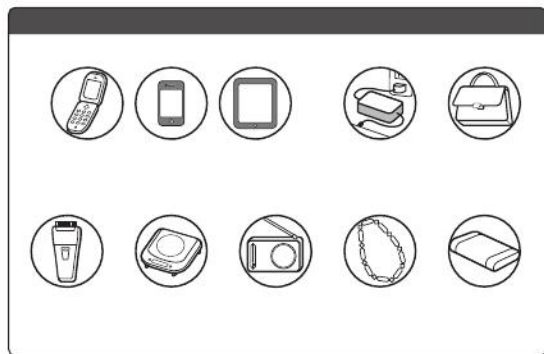

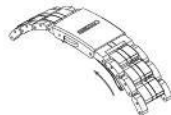
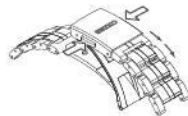
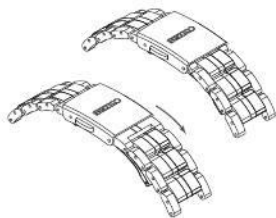

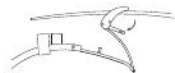
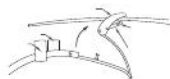
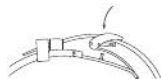
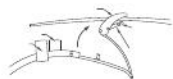

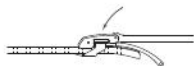
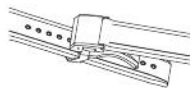



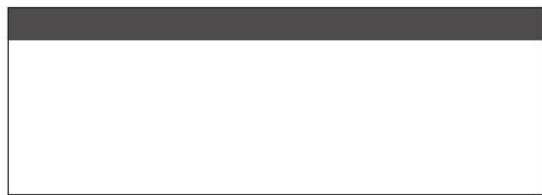





X \_\_\_\_\_

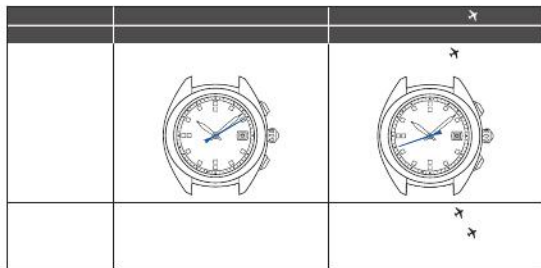

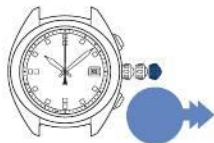



### ■ Preliminary position of this watch

The preliminary position of the date is "1" (1st).

The preliminary position of the hour/minute hands is "12:00 AM".

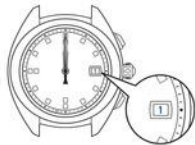

### ■ Set the standard position of the date and the hour and minute hands

#### 1 Pull out the crown to the second click

The seconds hand will move to the 0-second position.



#### 2 Continue to press Button B (3 seconds)

The watch enters the mode for setting the standard position of the date.



\* During movement of the date, the buttons cannot be operated.

The seconds hand stops at the 18-second position.

The date moves, and stops when it indicates the standard position.

#### 3 Turn the crown to adjust the date to "1"

Adjust so that the numeral "1" appears in the center of the date window.

\* If "1" is displayed, go to operation 4

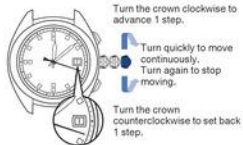





---

---

				
		x x		
			x	









