

Contents

Precautions

Operating Precautions

User Maintenance

Battery Replacement

Before Getting Started

General Guide

Indicators

Navigating Between Modes

Viewing the Face in the Dark

Time Adjustment

Adjusting the Current Time Setting

Alarm

Configuring Alarm Settings

Enabling/Disabling an Alarm or the Hourly Time Signal

Turning Off an Alarm or the Hourly Time Signal

Stopwatch

Measuring Elapsed Time

Measuring a Split Time

Timing the First and Second Place Finishers

Timer

Setting the Time

Using the Timer

Other Settings

Configuring Flash Alert Settings

Other Information

Specifications

Troubleshooting

Precautions

Operating Precautions

● Water Resistance

- The information below applies to watches with WATER RESIST or WATER RESISTANT marked on the back cover.

Water Resistance Under Daily Use

Marking on watch front or on back cover	No BAR mark
---	-------------

Example of Daily Use

Hand washing, rain	Yes
Water-related work, swimming	No
Windsurfing	No
Skin diving	No

Enhanced Water Resistance Under Daily Use

5 Atmospheres

Marking on watch front or on back cover	5BAR
---	------

Example of Daily Use

Hand washing, rain	Yes
Water-related work, swimming	Yes
Windsurfing	No
Skin diving	No

10 Atmospheres

Marking on watch front or on back cover	10BAR
---	-------

Example of Daily Use

Hand washing, rain	Yes
Water-related work, swimming	Yes
Windsurfing	Yes
Skin diving	Yes

20 Atmospheres

Marking on watch front or on back cover	20BAR
---	-------

Example of Daily Use

Hand washing, rain	Yes
Water-related work, swimming	Yes
Windsurfing	Yes
Skin diving	Yes

- Do not use your watch for scuba diving or other types of diving that requires air tanks.

- Watches that do not have WATER RESIST or WATER RESISTANT marked on the back cover are not protected against the effects of sweat. Avoid using such a watch under conditions where it will be exposed to large amounts of sweat or moisture, or to direct splashing with water.
- Even if a watch is water resistant, note the usage precautions described below. Such types of use reduce water resistance performance and can cause fogging of the glass.
 - Do not operate the crown or buttons while your watch is submersed in water or wet.
 - Avoid wearing your watch while in the bath.
 - Do not wear your watch while in a heated swimming pool, sauna, or any other high temperature/high humidity environment.
 - Do not wear your watch while washing your hands or face, while doing housework, or while performing any other task that involves soaps or detergents.
- After submersion in seawater, use plain water to rinse all salt and dirt from your watch.
- To maintain water resistance, have the gaskets of your watch replaced periodically (about once every two or three years).
- A trained technician will inspect your watch for proper water resistance whenever you have its battery replaced. Battery replacement requires the use of special tools. Always request battery replacement from your original retailer or from an authorized CASIO service center.
- Some water-resistant watches come with fashionable leather bands. Avoid swimming, washing, or any other activity that causes direct exposure of a leather band to water.
- The inside surface of the watch glass may fog when the watch is exposed to a sudden drop in temperature. No problem is indicated if the fogging clears up relatively quickly. Sudden and extreme temperature changes (such as coming into an air conditioned room in the summer and standing close to an air conditioner outlet, or leaving a heated room in the winter and allowing your watch to come into contact with snow) can cause it to take longer for glass fogging to clear up. If glass fogging does not clear up or if you notice moisture inside of the glass, immediately stop using your watch and take it to your original retailer or to an authorized CASIO service center.
- Your water-resistant watch has been tested in accordance with International Organization for Standardization regulations.

● Band

- Tightening the band too tightly can cause you to sweat and make it difficult for air to pass under the band, which can lead to skin irritation. Do not fasten the band too tightly. There should be enough room between the band and your wrist so you can insert your finger.
- Deterioration, rust, and other conditions can cause the band to break or come off of your watch, which in turn can cause band pins to fly out of position or to fall out. This creates the risk of your watch falling from your wrist and becoming lost, and also creates the risk of personal injury. Always take good care of your band and keep it clean.
- Immediately stop using a band if you even notice any of the following: loss of band flexibility, band cracks, band discoloration, band looseness, band connecting pin flying or falling out, or any other abnormality. Take your watch to your original retailer or to a CASIO service center for inspection and repair (for which you will be charged) or to have the band replaced (for which you will be charged).

● Temperature

- Never leave your watch on the dashboard of a car, near a heater, or in any other location that is subject to very high temperatures. Do not leave your watch where it will be exposed to very low temperatures. Temperature extremes can cause your watch to lose or gain time, to stop, or otherwise malfunction.
- Leaving your watch in an area hotter than +60 °C (140 °F) for long periods can lead to problems with its LCD. The LCD may become difficult to read at temperatures lower than 0 °C (32 °F) and greater than +40 °C (104 °F).

● Impact

- Your watch is designed to withstand impact incurred during normal daily use and during light activity such as playing catch, tennis, etc. Dropping your watch or otherwise subjecting it to strong impact, however, can lead to malfunction. Note that watches with shock-resistant designs (G-SHOCK, BABY-G, G-MS) can be worn while operating a chain saw or engaging in other activities that generate strong vibration, or while engaging in strenuous sports activities (motocross, etc.)

● Magnetism

- Though a digital watch normally is not affected by magnetism, very strong magnetism (from medical equipment, etc.) should be avoided because it can cause malfunction and damage to electronic components.

● Electrostatic Charge

- Exposure to very strong electrostatic charge can cause your watch to display the wrong time. Very strong electrostatic charge even can damage electronic components.
- Electrostatic charge may cause temporary blotching in blank areas of the LCD.

● Chemicals

- Do not allow your watch to come into contact with thinner, gasoline, solvents, oils, or fats, or with any cleaners, adhesives, paints, medicines, or cosmetics that contain such ingredients. Doing so can cause discoloration of or damage to the resin case, resin band, leather, and other parts.

● Storage

- If you do not plan to use your watch for a long time, thoroughly wipe it free of all dirt, sweat, and moisture, and store it in a cool, dry place.

● Resin Components

- Allowing your watch to remain in contact with other items or storing it together with other items for long periods while it is wet can cause color on resin components to transfer to the other items, or the color of the other items to transfer to the resin components of your watch. Be sure to dry off your watch thoroughly before storing it and make sure it is not in contact with other items.
- Leaving your watch where it is exposed to direct sunlight (ultraviolet rays) for long periods or failure to clean dirt from your watch for long periods can cause it to become discolored.
- Friction caused by certain conditions (strong external force, sustained rubbing, impact, etc.) can cause discoloration of painted components.
- If there are printed figures on the band, strong rubbing of the printed area can cause discoloration.
- Leaving your watch wet for long periods can cause fluorescent color to fade. Wipe the watch dry as soon as possible after it becomes wet.
- Semi-transparent resin parts can become discolored due to sweat and dirt, and if exposed to high temperatures and humidity for long periods.
- Daily use and long-term storage of your watch can lead to deterioration, breaking, or bending of resin components. The extent of such damage depends on usage conditions and storage conditions.

● Leather Band

- Allowing your watch to remain in contact with other items or storing it together with other items for long periods while it is wet can cause the color of the leather band to transfer to the other items or the color of the other items to transfer to the leather band. Be sure to dry off your watch thoroughly with a soft cloth before storing it and make sure it is not in contact with other items.
- Leaving a leather band where it is exposed to direct sunlight (ultraviolet rays) for long periods or failure to clean dirt from a leather band for long periods can cause it to become discolored.

CAUTION:

Exposing a leather band to rubbing or dirt can cause color transfer and discoloration.

● Metal Components

- Failure to clean dirt from metal components can lead to formation of rust, even if components are stainless steel or plated. If metal components exposed to sweat or water, wipe thoroughly with a soft, absorbent cloth and then place the watch in a well-ventilated location to dry.
- Use a soft toothbrush or similar tool to scrub the metal with a weak solution of water and a mild neutral detergent, or with soapy water. Next, rinse with water to remove all remaining detergent and then wipe dry with a soft absorbent cloth. When washing metal components, wrap the watch case with kitchen plastic wrap so it does not come into contact with the detergent or soap.

● Bacteria and Odor Resistant Band

- The bacteria and odor resistant band protects against odor generated by the formation of bacteria from sweat, which ensures comfort and hygiene. In order to ensure maximum bacteria and odor resistance, keep the band clean. Use an absorbent soft cloth to thoroughly wipe the band clean of dirt, sweat, and moisture. A bacteria and odor resistant band suppresses the formation of organisms and bacteria. It does not protect against rash due to allergic reaction, etc.

● Liquid Crystal Display

- Display figures may be difficult to read when viewed from an angle.

Note that CASIO Computer Co., Ltd. assumes no responsibility for any damage or loss suffered by you or any third party arising through the use of your watch or its malfunction.

User Maintenance

● Caring for Your Watch

Remember that you wear your watch next to your skin, just like a piece of clothing. To ensure your watch performs at the level for which it is designed, keep it clean by frequently wiping with a soft cloth to keep your watch and band free of dirt, sweat, water and other foreign matter.

- Whenever your watch is exposed to sea water or mud, rinse it off with clean fresh water.
- For a metal band or a resin band with metal parts, use a soft toothbrush or similar tool to scrub the band with a weak solution of water and a mild neutral detergent, or with soapy water. Next, rinse with water to remove all remaining detergent and then wipe dry with a soft absorbent cloth. When washing the band, wrap the watch case with kitchen plastic wrap so it does not come into contact with the detergent or soap.
- For a resin band, wash with water and then wipe dry with a soft cloth. Note that sometimes a smudge like pattern may appear on the surface of a resin band. This will not have any effect on your skin or clothing. Wipe with a cloth to remove the smudge pattern.
- Clean water and sweat from a leather band by wiping with a soft cloth.
- Not operating a watch crown, buttons, or rotary bezel could lead to later problems with their operation. Periodically rotate the crown and rotary bezel, and press buttons to maintain proper operation.

● Dangers of Poor Watch Care

Rust

- Though the metal steel used for your watch is highly rust-resistant, rust can form if your watch is not cleaned after it becomes dirty.
 - Dirt on your watch can make it impossible for oxygen to come into contact with the metal, which can lead to breakdown of the oxidization layer on the metal surface and the formation of rust.
- Rust can cause sharp areas on metal components and can cause band pins to fly out of position or to fall out. If you ever notice any abnormality immediately stop using your watch and take it to your original retailer or to an authorized CASIO service center.
- Even if the surface of the metal appears clean, sweat and rust in crevasses can soil the sleeves of clothing, cause skin irritation, and even interfere with watch performance.

Premature Wear

- Leaving sweat or water on a resin band or bezel, or storing your watch an area subject to high moisture can lead to premature wear, cuts, and breaks.

Skin Irritation

- Individuals with sensitive skin or in poor physical condition may experience skin irritation when wearing a watch. Such individuals should keep their leather band or resin band particularly clean. Should you ever experience a rash or other skin irritation, immediately remove your watch and contact a skin care professional.

Battery Replacement

- Leave battery replacement up to your original retailer or authorized CASIO service center.
- Have the battery replaced only with the type specified in the “Specifications”. Use of a different battery type can cause malfunction.
- When replacing the battery, also request a check for proper water resistance.
- Ornamental resin components may become worn, cracked, or bent over time when subjected to normal daily use. Note that if cracking or any other abnormality indicating possible damage is noticed in a watch submitted for battery replacement, your watch will be returned with an explanation of the abnormality, without the requested servicing being performed.

● Initial Battery

- The battery that comes loaded in your watch when you purchase it is used for function and performance testing at the factory.
- The test battery may go dead quicker than the normally rated battery life noted in the “Specifications”. Note that you will be charged for replacement of this battery, even if replacement is required within your watch’s warranty period.

● Low Battery Power

- Low battery power is indicated by large timekeeping error, by dim display contents, or by a blank display.
- Operation while battery power is low can result in malfunction. Replace the battery as soon as possible.

Before Getting Started

This section provides an overview of the watch and introduces convenient ways it can be used.

● Watch Features

• Alarm

An alarm sounds whenever a time specified by you is reached.

• Timer

Countdown from a start time specified by you. An alarm sounds when the countdown reaches zero.

• Stopwatch

The stopwatch measures elapsed time in units of one second (1/100 second for the first hour) up to 24 hours.

Note

- The illustrations included in this operation guide have been created to facilitate explanation. An illustration may differ somewhat from the item it represents.

General Guide

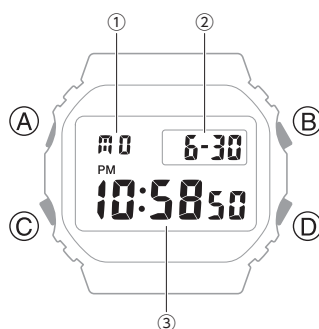

- ① Day of the week
- ② Month, day
- ③ Hour, minute, second

A button

Pressing this button in any mode displays the setting screen.

- Some watch models are designed so their (A) button is recessed more than the other buttons.

B button

Press to turn on illumination.

C button

Each press cycles between watch modes.

Pressing this button after performing operations in any mode returns to the Timekeeping Mode.

D button

Holding down this button for at least two seconds in the Timekeeping Mode toggles flash alert between enabled and disabled.

Indicators

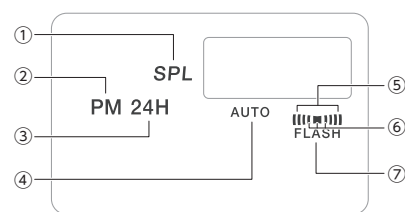

- ① Displayed while a split time measurement operation is in progress.
- ② Displayed during p.m. times while 12-hour timekeeping is being used.
- ③ Displayed while 24-hour timekeeping is being used.
- ④ Displayed while Auto Repeat Timer is enabled.
- ⑤ Displayed while an alarm is turned on.
- ⑥ Displayed while the hourly time signal is enabled.
- ⑦ Displayed while flash alert is enabled.

Navigating Between Modes

Press (C) to cycle between modes.

- After performing operations in any mode, press (C) to return to the Timekeeping Mode.

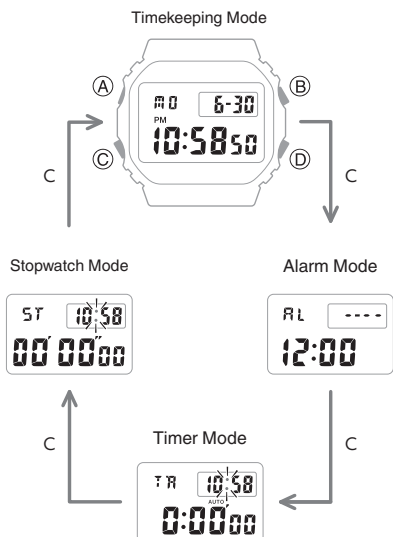

Viewing the Face in the Dark

The watch has a light that illuminates the face for viewing in the dark.

Turning On Display Illumination

Press (B) to turn on illumination.

- Illumination will turn off automatically if an alarm starts to sound.



Important!

- Frequent use of illumination will run down the battery.

Note

- Display illumination is disabled when any one of the conditions below exists.
 - Alarm, timer alert, or other beeper sounding

Time Adjustment

Use the procedures in this section to adjust the date and time settings.



Adjusting the Current Time Setting

Use the procedures in this section to adjust the date and time settings.

Setting the Time/Date

1. Enter the Timekeeping Mode.
 ◉ [Navigating Between Modes](#)
2. Press (A).
 This causes the seconds to flash.

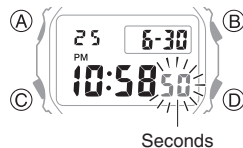

3. Keep pressing (C) until the setting you want to change is flashing.
 - Each press of (C) moves the flashing to the next setting in the sequence shown below.

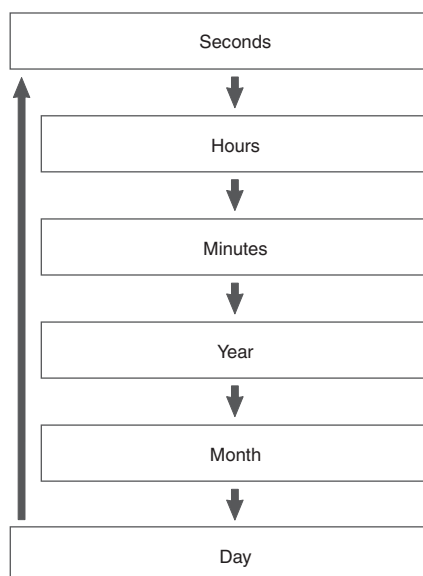

4. Configure the date and time settings.
 - While the seconds are flashing, pressing (D) resets them to 00. 1 is added to the minutes when the current count is between 30 and 59 seconds.
 - For all the other values, use (D) to change the flashing setting. Holding down (D) scrolls through settings at high speed.
5. Repeat steps 3 and 4 to select time and date settings.
6. Press (A) to complete the setting operation.

Note

- While the setting is being configured, the watch will exit the setting operation automatically after about two or three minutes of non-operation.

Switching between 12-hour and 24-hour Timekeeping

You can specify either 12-hour format or 24-hour format for the time display.

1. Enter the Timekeeping Mode.
 ◉ [Navigating Between Modes](#)
2. Press (A).
 This causes the seconds to flash.



3. Press (B) to select 12-hour or 24-hour timekeeping.

Each press of (B) toggles between 12-hour and 24-hour timekeeping.

- [PM] is displayed during p.m. times while 12-hour timekeeping is being used.

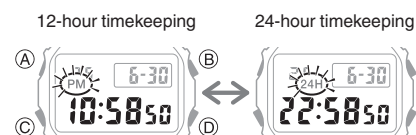

4. Press (A) to complete the setting operation.

Note

- While the setting is being configured, the watch will exit the setting operation automatically after about two or three minutes of non-operation.

Alarm

The watch will beep when an alarm time is reached.

The hourly time signal causes the watch to beep every hour on the hour.



- If flash alert is enabled, display illumination will flash along with the alarm beeper and the hourly time signal.

[Configuring Flash Alert Settings](#)

Configuring Alarm Settings

There are various alarm variations, and the variation that is set depends on the hour, minute, month, and day settings you configure.

- **Configuring Some of the Settings (hour, minute, month, day)**
 - **Hour and Minute Settings Only**
The alarm sounds every day at the specified time.
 - **Month, Hour and Minute Settings Only**
The alarm sounds every day of the specified month at the specified time.
 - **Day, Hour and Minute Settings Only**
The alarm sounds every month at the specified time on the specified day.
- **All Settings: Hour, Minute, Month, Day**
The alarm sounds once at the specified time on the specified date.

1. Enter the Alarm Mode.

[Navigating Between Modes](#)

2. Press (A).

This causes the hours digits to flash.



Alarm hour

3. Keep pressing (C) until the setting you want to change is flashing.

- Each press of (C) moves the flashing to the next setting in the sequence shown below.

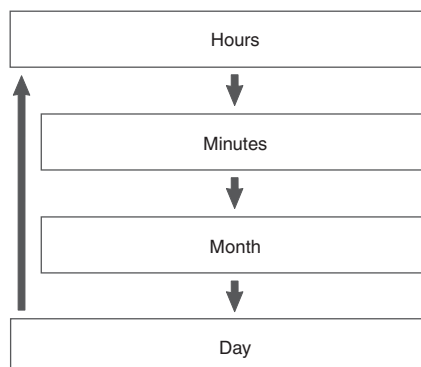

4. Use (D) to change the value.

- Holding down (D) scrolls through settings at high speed.
- [-] is displayed for the month and [- -] is displayed for the day if nothing is specified for these settings.
- While you are setting the timekeeping hour, [PM] (p.m.) is displayed during p.m. times if you are using 12-hour timekeeping, while [24H] is displayed if you are using 24-hour timekeeping.



5. Repeat steps 3 and 4 to select time and date settings.

6. Press (A) to complete the setting operation.

Note

- While the setting is being configured, the watch will exit the setting operation automatically after about two or three minutes of non-operation.

To stop the alarm

To stop the alarm after it starts to sound when an alarm time is reached, press any button.

Note

- A beeper sounds for 20 seconds to let you know when the alarm time is reached.
- If flash alert is enabled, display illumination flashes along with the alarm beeper and the hourly time signal. Pressing any button to stop the alarm beeper also stops the flash alert operation.

[Configuring Flash Alert Settings](#)

Enabling/Disabling an Alarm or the Hourly Time Signal

- Enter the Alarm Mode.
[Navigating Between Modes](#)
- Use (D) to cycle through the available alarm and hourly time signal settings.
 - Each press of (D) cycles through the alarm and hourly time signal settings in the sequence shown below.

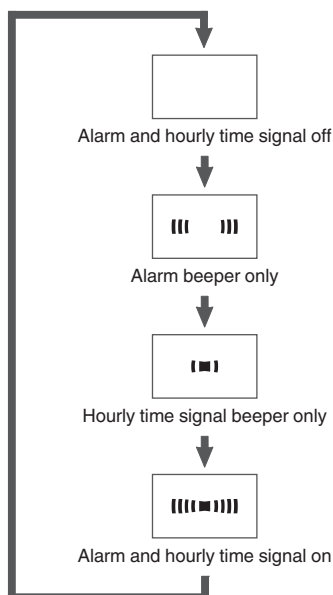
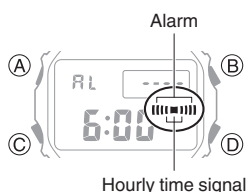

Turning Off an Alarm or the Hourly Time Signal

To stop an alarm or the hourly time signal from sounding, use the steps below to select the setting you want.

- To turn an alarm or hourly time signal back on, use the steps below to select the setting you want.

- Enter the Alarm Mode.
[Navigating Between Modes](#)
- Use (D) to cycle through the available alarm and hourly time signal settings.
 - Each press of (D) cycles through the alarm and hourly time signal settings in the sequence shown below.

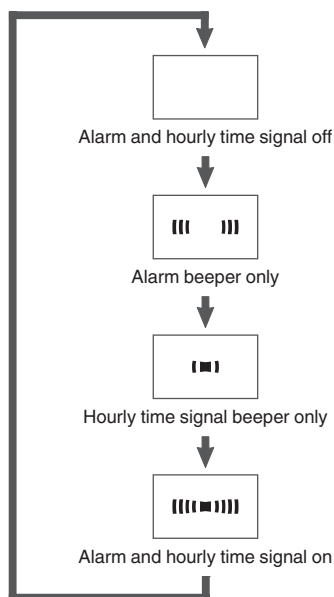
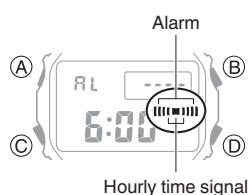

Stopwatch

The stopwatch can measure elapsed time up to 23 hours, 59 minutes, 59 seconds (24 hours).

When this maximum limit is exceeded, elapsed time measurement returns to 0 and timing continues from there.



Measuring Elapsed Time

- Enter the Stopwatch Mode.
[Navigating Between Modes](#)
- Use the operations below to measure elapsed time.

- (D) Start
- ↓
- (D) Stop
- ↓
- (D) Resume
- ↓
- (D) Stop

- Elapsed time is shown in 1/100-second units for the first hour of the measurement. After the first hour, elapsed time is shown in one-second units.

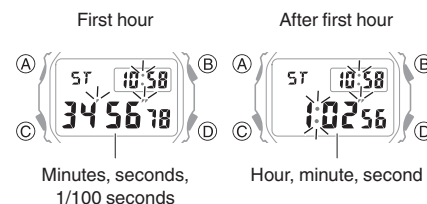

- Press (A) to reset the measurement time to all zeros.

Measuring a Split Time

1. Enter the Stopwatch Mode.
[Navigating Between Modes](#)
2. Use the operations below to measure elapsed time.
 - Pressing (A) displays the elapsed time from the start of a race up to the point when you pressed the button (split time).

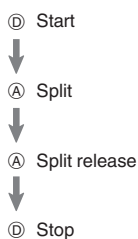

- Elapsed time is shown in 1/100-second units for the first hour of the measurement. After the first hour, elapsed time is shown in one-second units.

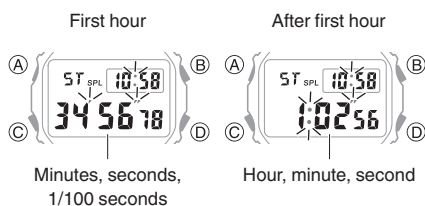

3. Press (A) to reset the measurement time to all zeros.

Timing the First and Second Place Finishers

1. Enter the Stopwatch Mode.
[Navigating Between Modes](#)
2. Use the operations below to measure elapsed time.



- * This displays the time of the first finisher.
- Elapsed time is shown in 1/100-second units for the first hour of the measurement. After the first hour, elapsed time is shown in one-second units.

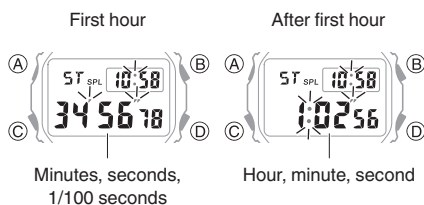

3. Press (A) to display the time of the second finisher.
4. Press (A) to reset the measurement time to all zeros.

Timer

The timer counts down from a start time specified by you. A beeper sounds when the end of the countdown is reached.



- If flash alert is enabled, display illumination flashes along with the beeper at the end of the countdown.

[Configuring Flash Alert Settings](#)

Using a Timer

Your watch provides you with two different types of timers. Select the timer you want to suit your needs.

Repeat Timer

With the Repeat Timer, countdown stops and the start time setting appears when the end of the countdown is reached.

The Repeat Timer comes in handy when you need to perform the same countdown operation a number of times.

Auto Repeat Timer

With Auto Repeat Timer, the countdown operation is automatically restarted from the start time when the end of the countdown is reached. This continues until you stop the countdown operation.

Setting the Time

The countdown start time can be set in 1-second units up to 24 hours.

- If a timer countdown operation is in progress, reset the timer to its current start time before performing this operation.

[Using the Timer](#)

1. Enter the Timer Mode.

[Navigating Between Modes](#)

2. Press (A).

This causes the hours digits to flash.

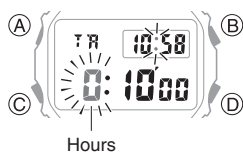

3. Use (D) to change the timer hour setting.

- Holding down (D) scrolls through settings at high speed.

4. Press (C).

This causes the minutes digits to flash.

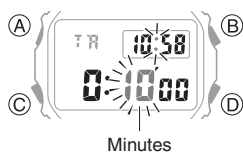

5. Use (D) to change the timer minute setting.

6. Press (C).

This causes the seconds digits to flash.

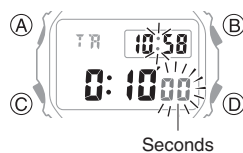

7. Use (D) to change the timer seconds setting.

8. Press (B) to select Repeat Timer or Auto Repeat Timer.

- Each press of (B) toggles between Repeat Timer and Auto Repeat Timer.
- [AUTO] is displayed while Auto Repeat is enabled.

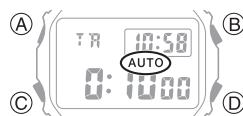

9. Press (A) to complete the setting operation.

Note

- While the setting is being configured, the watch will exit the setting operation automatically after about two or three minutes of non-operation.
- Setting a start time of [0:00'00] will perform a countdown of 24 hours.

Using the Timer

1. Enter the Timer Mode.

[Navigating Between Modes](#)



2. Use the operations below to perform a timer operation.

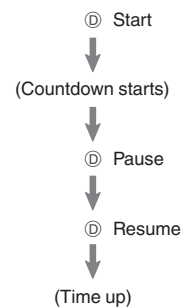

- A beeper will sound for 10 seconds to let you know when the end of a countdown is reached.
- When using the auto-repeat timer with a countdown of 10 seconds or less, the countdown end beeper will sound for only one second.
- To reset a paused countdown to the start time, press (A).

3. Press any button to stop the tone.

Note

- If flash alert is enabled, display illumination flashes along with the beeper at the end of the countdown. Pressing any button to stop the alarm beeper also stops the flash alert operation.

[Configuring Flash Alert Settings](#)

Other Settings

This section explains other watch settings you can configure.

Configuring Flash Alert Settings

If flash alert is enabled, display illumination will automatically flash along with the alarm, timer, and other beepers.

1. Enter the Timekeeping Mode.
 [Navigating Between Modes](#)
2. Hold down (D) for at least two seconds to toggle flash alert between enabled and disabled.
 - Flash alert toggles between on and off each time you hold down (D).
 - [FLASH] is displayed while flash alert is enabled.



Other Information

This section provides non-operational information you also need to know. Refer to this information as required.

Specifications

Accuracy at normal temperature :

±15 seconds per month

Timekeeping :

Hour, minute, second, month, day, day of the week
 a.m./p.m. (PM)/24-hour timekeeping (24H)
 Full Auto Calendar (2000 to 2099)

Alarm :

Time alarm
 Setting units: month, day, hour, minute
 Alarm beeper duration: 20 seconds
 Hourly time signal: Beep every hour on the hour

Timer :

Measuring unit: 1 second
 Countdown range: 24 hours
 Time setting unit: 1 second
 Auto Repeat
 10-second beeper when the end of the countdown is reached

Stopwatch :

Measurement units:
 1/100 seconds (first hour); 1 second (after first hour)
 Measuring range:
 23 hours, 59 minutes, 59 seconds (24 hours)
 Measurement Functions:
 Elapsed time, split times, 1st and 2nd place finisher times

Other :

Auto return, 12-/24-hour timekeeping, LED backlight (Super Illuminator, afterglow), flash alert

Power Supply :

CR2016 x 1
 Battery nominal voltage: 3V
 Battery life: Approximately 5 years
 Conditions:
 Alarm: Once (20 seconds)/day (flash alert enabled)
 Illumination: Once (3.5 seconds)/day

Specifications are subject to change without notice.

Troubleshooting

Alarm and Hourly Time Signal

Q1 An alarm does not sound.

The alarm's settings may not be configured. Configure the alarm settings.

[Enabling/Disabling an Alarm or the Hourly Time Signal](#)

Q2 The hourly time signal does not sound.

The hourly time signal may be disabled. Enable the hourly time signal.

[Enabling/Disabling an Alarm or the Hourly Time Signal](#)

Other

Q1 I can't find the information I need here.

Visit the website below.

<https://world.casio.com/support/>