

CITIZEN WATCH CO., LTD.

This drawing is provisional and subject to our reconfirmation and/or revision without notice.

DH1~DH2=20947 (#30)

Coordinates			
Point	X	Y	R
DM	0	0	—
DH1	-10413	-2722	—
DH2	-10022	-4886	—
B1	8364	8669	1200
B2	-8476	8602	1200
B3	-8078	-10529	2000
B4	-7303	-11081	2000
B5	8494	-10197	2000
B6	9203	-9562	2000

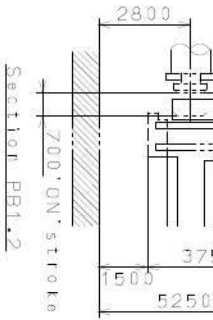
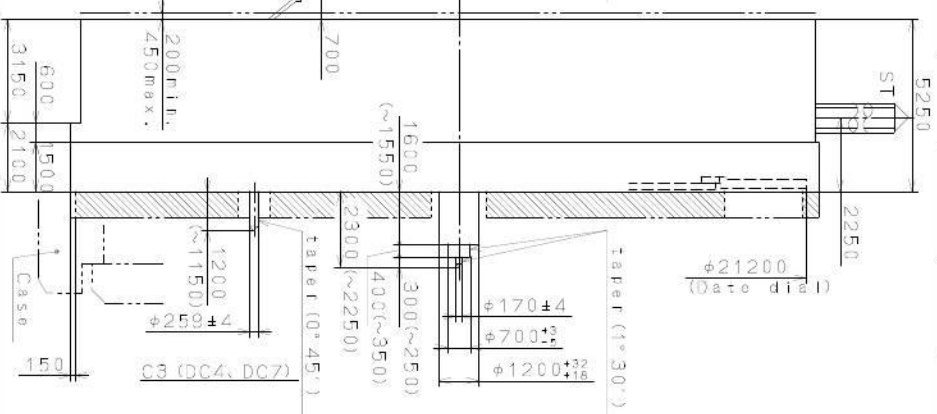
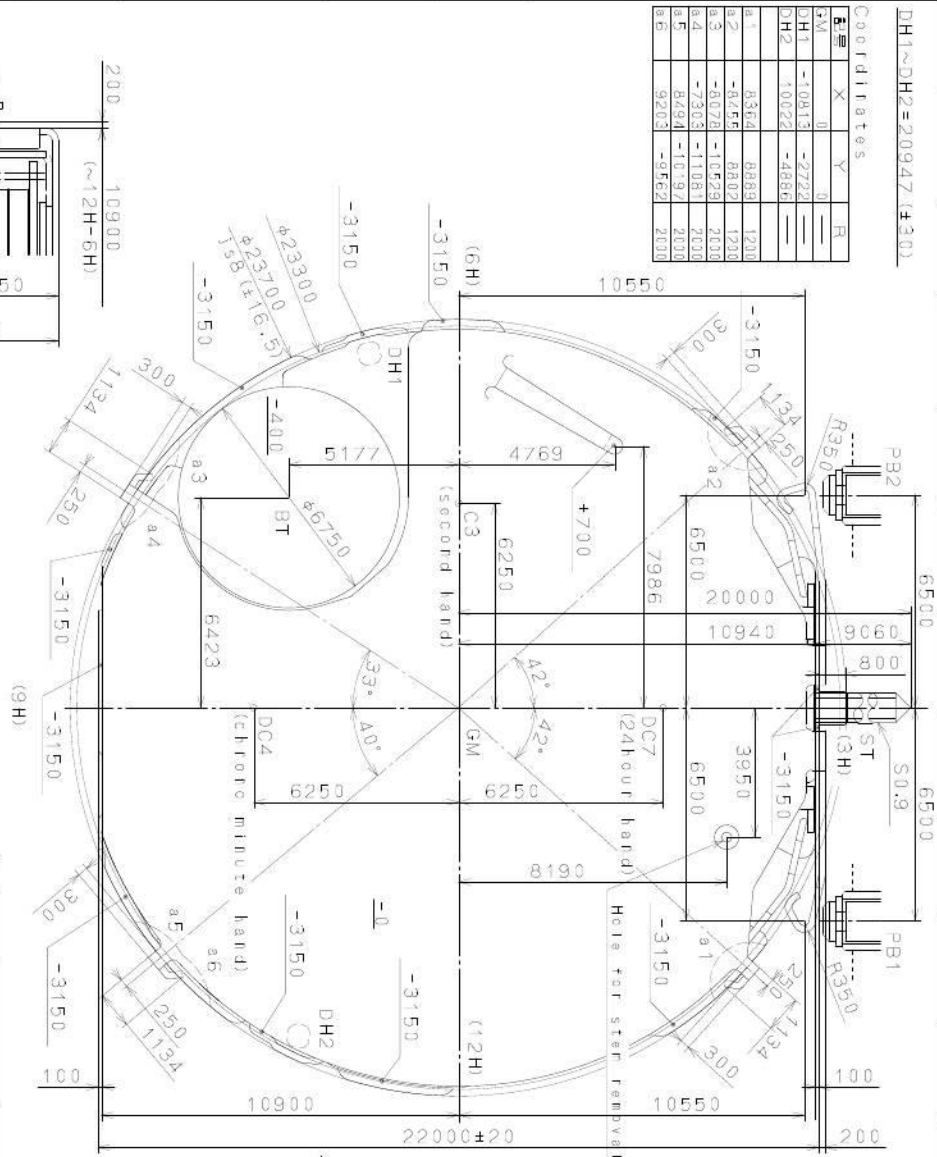

No.	Quantity	Unit	Material	Part No.
1	1	PC	47400000	ES24
2	1	PC	811	Parts No.:
3	1	PC	Date:	
4	1	PC	Task:	
5	1	PC	Checked:	N. SUZUKI
6	1	PC	Approved:	
7	1	PC	Frame for Case:	
8	1	PC	Design No.:	FS240003
9	1	PC	Special Features:	
10	1	PC	Address:	
11	1	PC	Area:	
12	1	PC	Division:	
13	1	PC	Project:	

MIYOTA
CITIZEN BATH CO., LTD., TOKYO, JAPAN

2008/06/23 (16:09:35)

This drawing is provisional and subject to our reconfirmation and/or revision without notice.

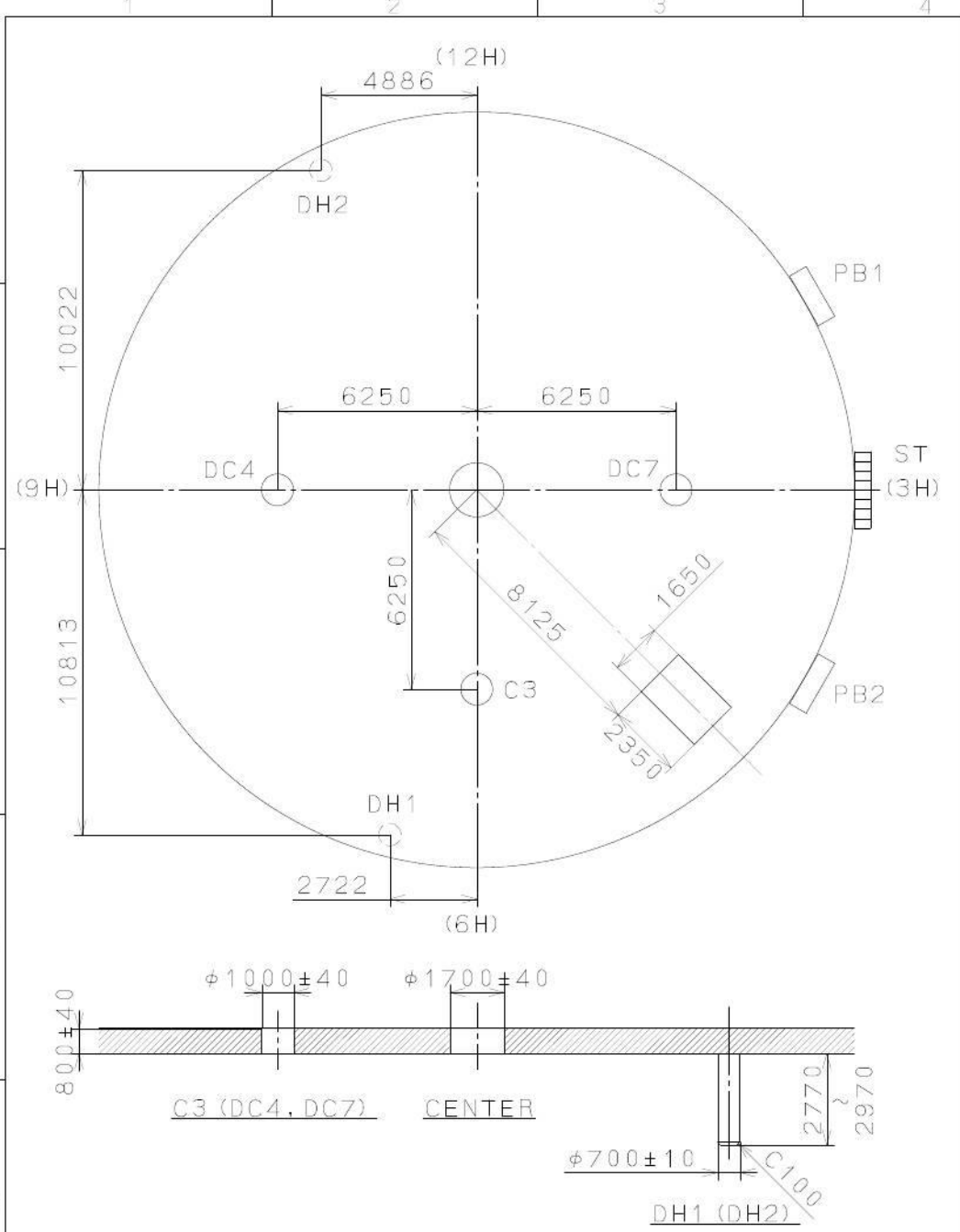

△			Quantity		Cal. NO.:
△			Unit	1/1000mm	FS23-00A
△			Scale	6:1	Parts No.:
△			Date		
△			Drawn		
Matl	Date	Description	Appro. Checked	N. Suzuki	Name:
		Alterations	Approved		Indications for Dial
Material					Drawing No.: FS230000
Heat Treatment			General Tolerances		MIYOTA
Hardness			Dimensions		
Plating			Angles		
					CITIZEN WATCH CO., LTD., TOKYO, JAPAN

2008/06/23 (16:10:33)

This drawing is provisional and subject to our reconfirmation and/or revision without notice.

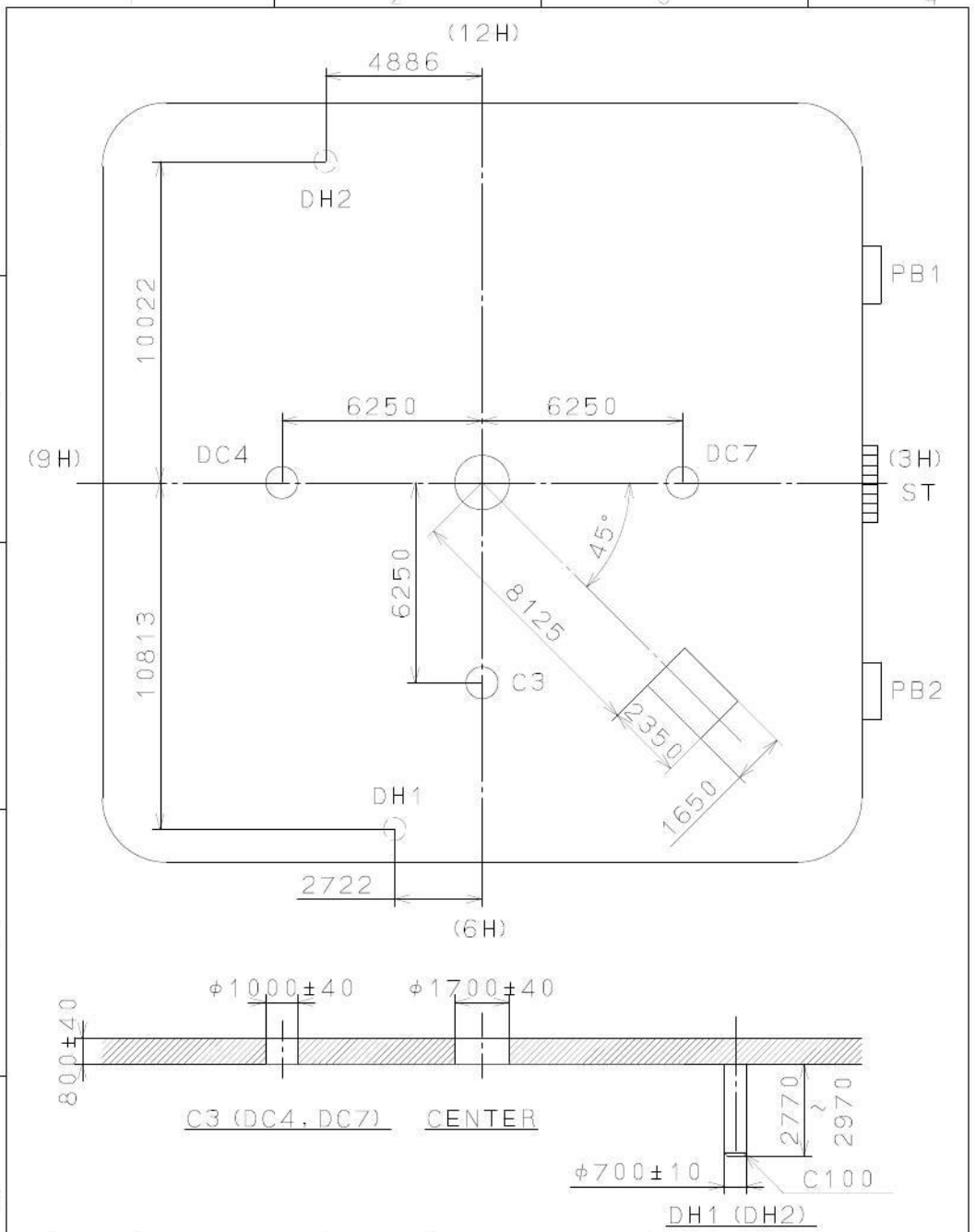

△			Quantity		Cal. NO.:
△			Unit	1/1000mm	FS24-00A
△			Scale	6:1	Parts No.:
△			Date		
△			Drawn		
Material			Checked	N. Suzuki	Name:
Heat Treatment			Approved		Indications for Dial
Hardness					Drawing No.: FS240000
Plating			General Tolerances		MIYOTA
			Dimensions		
			Angles		
				CITIZEN WATCH CO., LTD., TOKYO, JAPAN	

This drawing is provisional and subject to our reconfirmation and/or revision without notice.

065-549 (101) *** (2100 1121) 01-12-07

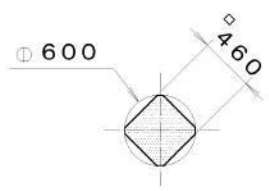

Section A-A

S0. 9, P=0. 225mm

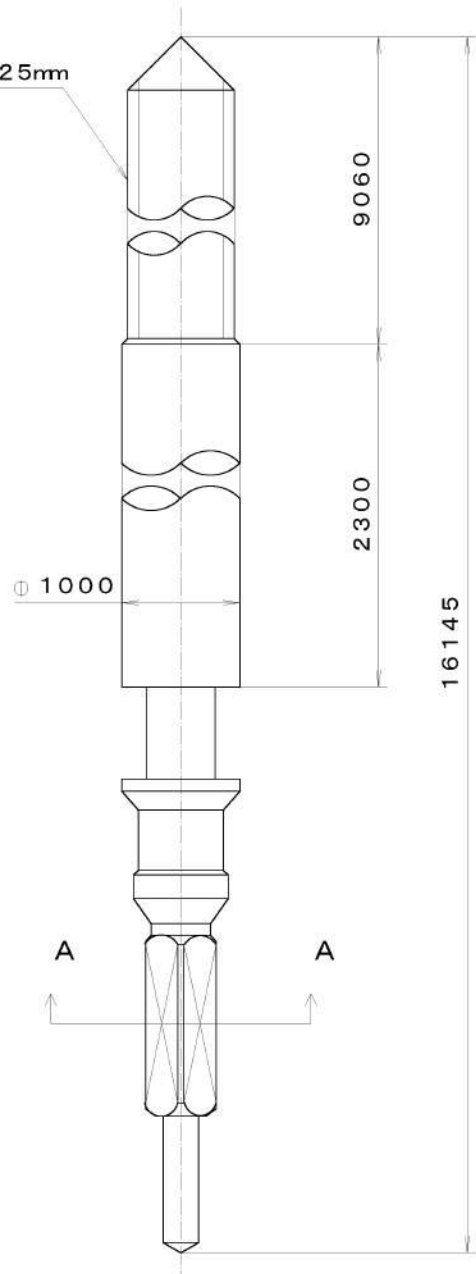

<input type="checkbox"/> <input type="checkbox"/> <input type="checkbox"/> <input type="checkbox"/> <input type="checkbox"/> <input type="checkbox"/>		Quantity			Cal. No. :	
		Unit	1/1000 mm		Parts:	
		Scale	20:1			065-549
		Date			Name: SETTING STEM	
		Drawn				Drawing No. : 5490S000
		Checked	T. Hiruta			
		Approved				
Material			General Tolerances		CITIZEN WATCH CO., LTD. TOKYO, JAPAN	
Heat Treatment			Dimensions			
Hardness			Angles			
Plating						

A) DISPLAYS AND BUTTONS

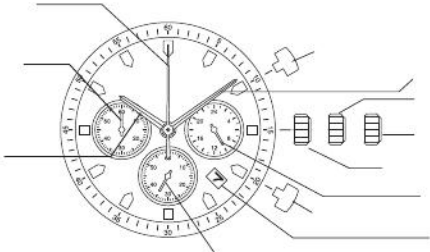

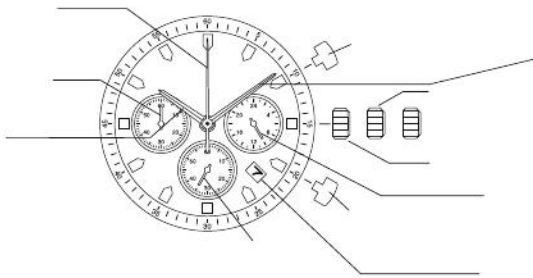

A) DISPLAY UND KNÖPFE

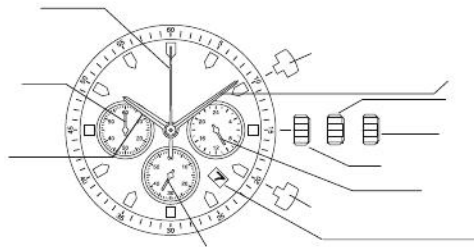



A) Indications et Boutons

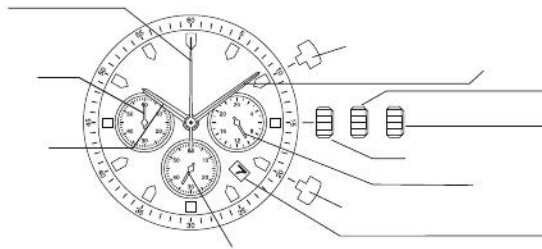



A) VISUALIZACIÓN Y BOTONES

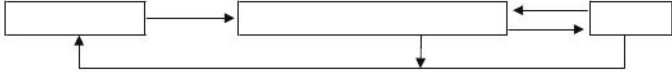
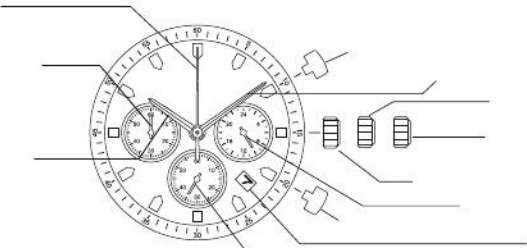



A) VISUALIZZAZIONI E PULSANTI

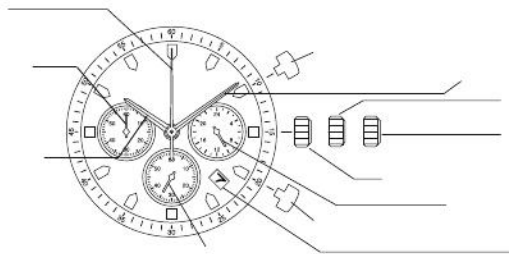

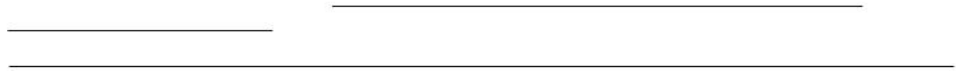

A) MOSTRADOR E BOTÕES

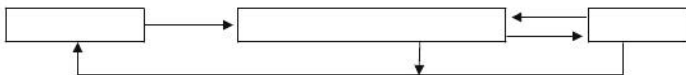
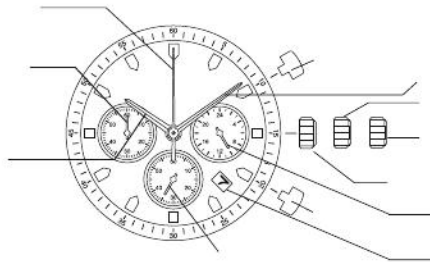

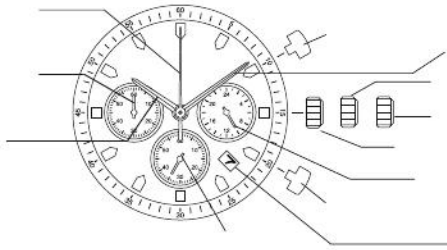

А) ЦИФЕРБЛАТ И КНОПКИ

