

SEIKO

**WATCH CASE
SERVICING GUIDE**

CONTENTS

GENERAL CONCEPTS OF SEIKO WATCH CASE SERVICING GUIDE	1
I. HOW TO USE SEIKO WATCH CASE SERVICING GUIDE	2
II. AFTER-SALES SERVICING INSTRUMENTS & MATERIALS AND THEIR USAGE	4
III. GENERAL REMARKS ON CASE CONSTRUCTION	6
1. General remarks for disassembling and reassembling	6
2. Caseback portion	7
3. Battery hatch	12
4. Button unit and crown unit	13
5. Crown portion	14
6. Disassembling and reassembling of the stem with crown	15
IV. LUBRICATION AND CLEANING	16
V. WATER RESISTANT TEST, AND REPAIR	17
1. Checking method	17
2. Checking and repairing method	18
VI. CASE SERVICING GUIDE BY TYPE OF CASE CONSTRUCTIONS	19
Chart for each type of case construction	
F type of case construction	21
A type of case construction	23
G type of case construction	35
H type of case construction	45
L type of case construction	47
R type of case construction	49
<i>B type of case construction</i>	51
E type of case construction	59
C type of case construction	63
K type of case construction	67
M type of case construction	69
P type of case construction	73

GENERAL CONCEPT OF SEIKO WATCH CASE SERVICING GUIDE

This case servicing guide consists of the following six chapters.

CHAPTER I. HOW TO USE THE WATCH CASE SERVICING GUIDE

Explains how to use the SEIKO Watch Case Servicing Guide.

CHAPTER II. AFTER-SALE SERVICING INSTRUMENTS & MATERIALS AND THEIR USAGE

Explains the after-sale servicing instruments and materials necessary for handling the casing parts.

CHAPTER III. GENERAL REMARKS FOR CASE CONSTRUCTION

Explains the general remarks for all case constructions (casebacks, crowns, etc.).

CHAPTER IV. LUBRICATION AND CLEANING

Specifies the types and quantity of oils to be applied, and the methods of cleaning the casing parts.

CHAPTER V. WATER RESISTANT TEST, AND SERVICING METHODS

Explains the methods of water resistant test and repairing for the water resistant watches (with water resistant case for ordinary use or with SPORTS 100 type case).

CHAPTER VI. CASE SERVICING GUIDE BY TYPE OF CASE CONSTRUCTION

Explains the disassembling and reassembling methods and remarks by type of case construction.

1. HOW TO USE SEIKO WATCH CASE SERVICING GUIDE

From September, 1978, the case construction marks have been inscribed on the caseback per each model, but at this time, the system of the marking has been changed. Since this SEIKO Watch Case Servicing Guide has been compiled in accordance with newly systemized case construction marks, it is necessary to confirm the construction mark on the caseback upon disassembling and reassembling a case. Regarding the models belonging to the previous system of the case construction marks, you can refer to the previously compiled SEIKO Watch Case Servicing Guide.

- Calibers applicable to the previous SEIKO Watch Case Servicing Guide

Mechanical : 11, 22, 29, 63 and 70 series.

Analogue Quartz : 13, 14, 23, 26, 34, 47, 59, 60, 71, 72, 75, 78, 79, 82, 93, 97 and 99 series.

Digital Quartz : A1, A2, A3, A4, B1, C3, F2, F4, L2, L4, L6, M3, M9 and S0 series.

Quartz Duo Display : H1 and H2 series.

- Calibers applicable to this SEIKO Watch Case Servicing Guide

Mechanical : 42 series

Analogue Quartz : 54, 64, 67, 84, 85, 86 and 94 series.

Digital Quartz : A5, A6, A9, B3, C4, D0, D1, D2, F6 and L1 series.

Quartz Duo Display : E0, H3, H4 and H5 series

All other calibers to be developed newly.

Note: The caseback markings may be inscribed in some models according to the old designation system. For your repair servicing, refer to the following case construction reference table.

Case construction reference table

Case No.	Caseback inscription in the old system	Marking used in this casing guide according to the new system	Case No.	Caseback inscription in the old system	Marking used in this casing guide according to the new system
H357- 5000	A	A0	H357- 507A	A	A0
5009	A	A0	507B	A	A0
500A	A	A0	5080	A	A0
500B	A	A0	5090	A	A0
500H	A	A0	509A	A	A0
5010	A	A0	L122- 5000	A	A2
5030	A	A0	5010	A	A2
5040	A	A0	5020	A	A2
5049	A	A0	5030	A	A2
5020	A	A0	5040	A	A2
502A	A	A0	5420- 001	R	R0
5029	A	A0	6423- 5000	R	R0
5050	A	A0	5010	A	A0
505A	A	A0	5020	R	R0
505B	A	A0	6429- 5000	R	R0
505C	A	A0	5010	R	R0
505D	A	A0	5019	R	R0
5060	A	A0	5020	R	R0
5070	A	A0	5030	R	R0
			6439- 500	R	R0

- To disassemble and reassemble a case, you need to know the construction of the case first. The case construction can be identified by the construction mark inscribed on the caseback. Second, you need to look up relevant instructions in CHAPTER VI, "CASE SERVICING GUIDE BY TYPE OF CASE CONSTRUCTION" by the construction mark.



A3

Construction mark (outlined at the end of the case No.)

In Chapter VI, instructions are given with emphasis on the glass portions.

<p>A3</p> <p>1. Construction and Remarks for Repair</p>	
--	--

- General remarks applicable to all cases, such as caseback, button, crown and other parts are explained in Chapter III. Check the case construction, and refer to the appropriate information.

[Construction mark]

- The construction mark is an alpha-numeric code.

A 3

Indicates a derivative of the basic construction, showing that the construction is slightly different in detail from the basic one.

A serial number (i.e., 0, 1, 2,) is assigned.

There are 13 basic constructions classified as to the glass removing method and module removing direction, etc. To identify the basic construction, one alphabetical letter is assigned.

II. AFTER-SALES SERVICING INSTRUMENTS & MATERIALS AND THEIR USAGE



Tightening tool (S-220)



Disk set

S-220: Water resistant case tightening tool

Tightening tool : Used to insert or remove the glass, bezel, caseback, etc.

Disk set : Used as an inserting or supporting disk to insert or support the caseback, bezel, etc.

Note: Be sure to place a vinyl sheet between the disk and case so as not to scratch the case.



Glass removing disk set (S-160)

S-160: Glass removing disk for water-resistant case

Used to remove the glass from the inside.

Note: The disk is provided with a notch to accommodate the stem pipe. Be sure to set the stem pipe in line with the notch.



Glass removing disks (S-161) (S-162)

S-161, S-162: Glass removing disk

Used to remove the glass other than round shape from a digital watch etc.

Note: When a panel cover or dial ring is provided, use the disk in such a manner so as not to touch it.



Glass inserting disk (S-173)

S-173: Glass inserting disk

Used to insert the glass for the case whose glass is projecting above the middle or bezel.

Note: If S-173 is used for the models having the middle (bezel) projecting above the glass surface, the glass will not be seated firm in position, because the inserting stroke will be insufficient.

When using S-173, be sure to check whether the glass is projecting or not.



Case holder (S-210D)

S-210D: Case holder

Used to hold a case having a screw type caseback when screwing on or off the caseback. S-210D can be fixed in a vise.



Case opener (S-280)

S-280: Case opener

Used to remove snap type caseback from the case.

Note: When using S-280, be sure to use a vinyl sheet or similar at the edge of the case opener so as to protect the case.



Case opener (S-290)

S-290: Case opener

Used to remove the leaf spring type caseback.

It can release the leaf springs simultaneously from the caseback through two notched holes.



Battery hatch opener (S-822)

S-822: Battery hatch opener

Used to open and close the battery hatch.

(Applicable to two-notched type and coin notch type)

Note: When opening or closing the battery hatch, be sure not to let the opener slip out of position.

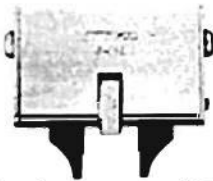

Speaker frame opener (S-832)

S-832: Speaker frame opener

Used to open and close the A0-series speaker frame and two-notched type battery hatch and bayonet type caseback.

(also used for opening two-notched type battery hatch and bayonet type caseback)



SEIKO glass adhesive (S-310)

S-310: SEIKO glass adhesive

Used to cement the glass.

Note: Don't use in a poorly ventilated area. Be sure to ventilate the workroom well when using it. When not in use, store the adhesive in a cool place or refrigerator.

III. GENERAL REMARKS ON CASE CONSTRUCTION

III-1. General remarks for disassembling and reassembling

1) Glass

Reassemble the glass with its rounded side facing down and set it so that it is level.

Some glasses are specially coated on the inside of the glass (ex. reinforced water-resistant case). Be careful not to touch the inside of these glasses with your fingers.

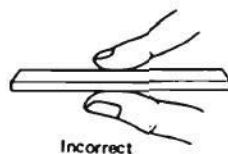
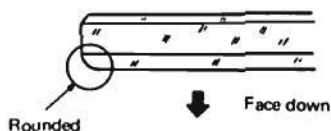

2) When removing the snap type caseback or bezel, remember the position of the opening notch. When reassembling, be sure to set the opening notch as it was.

If the caseback (bezel) is not set in the proper position, the opening notch may be positioned in a location under the middle whether it might be difficult to disassemble. The stem pipe may also be deformed.

Before disassembling

After reassembling

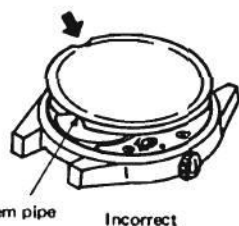
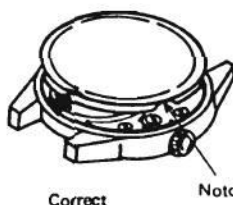
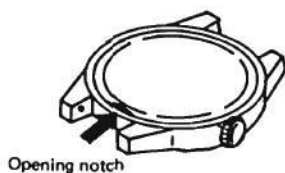
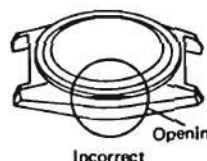
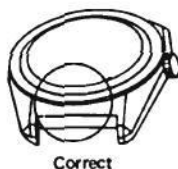

3) Some snap type casebacks also require their positioning notch to come to a designated position. If the positioning notch is positioned incorrectly for these casebacks, the battery hatch also will be positioned incorrectly. This makes it impossible for the battery to be set in position. Even if the battery is set, the caseback can not be reassembled because the battery keeps the caseback from being reassembled correctly. Before reassembling the caseback, be sure to position correctly the mark or groove for correct positioning of the caseback.

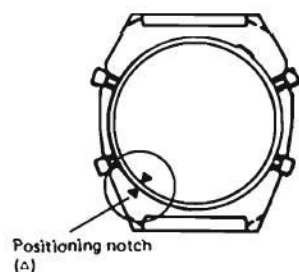
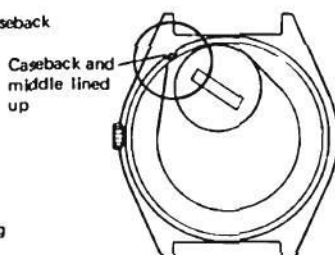
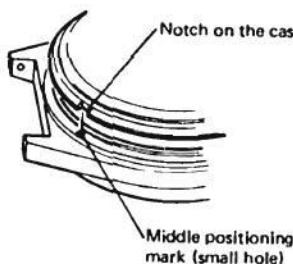

4) When setting the case ring in position, be sure to align its notches with the buttons or stem.

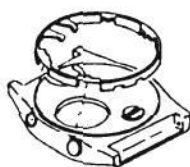

5) When disassembling and reassembling the caseback or bezel, be careful not to let dust and lint enter the case. When prying open the caseback or bezel, place a vinyl sheet at the working edge of the opener so as not to scratch the case, bezel and gasket.

III-2. Caseback portion

The casebacks are classified by case construction as follows.

1) Snap type (subclassified into type I (outside fit type) and type II (inside fit type))

• Type I (outside fit type)

How to open

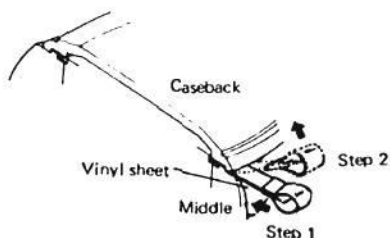

Insert the case opener in the opening notch, and pry the caseback up as illustrated above.

How to close

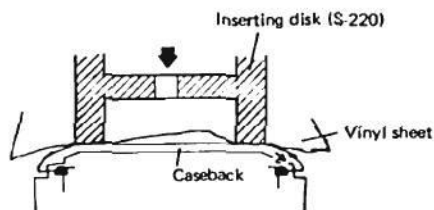

Push the caseback in with the SEIKO tightening tool (S-220) by using an inserting disk whose outside diameter is smaller than that of the caseback. Be sure to push down on the flat portion of the caseback.

• Type II (inside fit type)

How to open

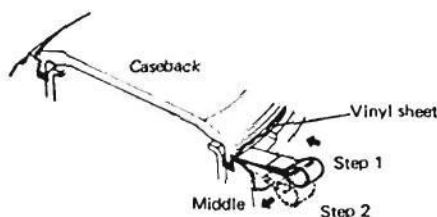

Insert the case opener in the opening notch, and pry the caseback down as illustrated above.

How to close

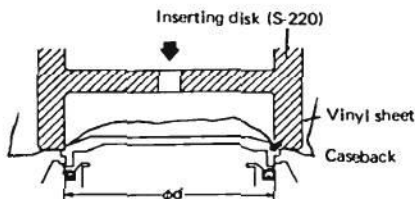

Push the caseback in with an inserting disk whose outside diameter is the same or bigger as the diameter " ϕd ".

Note: Be careful not to push down on the central flat surface of the caseback or it may not be set in position but it will bend.

2) Screw type (screw ring type)

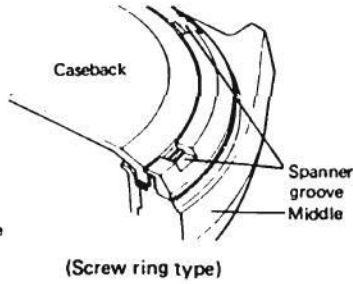
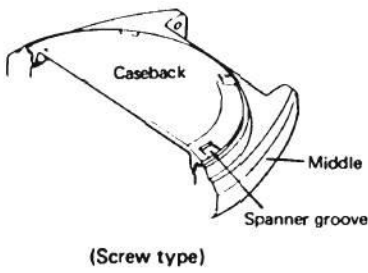

How to open and close
Hold the case by the case holder (S-210D), and turn the caseback (case ring) with the case opener.

Note: Be careful not to scratch the case by slipping with the case opener.

3) Male-female snap type (subclassified into snap-in type and snap-out type)

- Snap-in type (Projection of caseback snaps between the walls of the middle)

How to disassemble

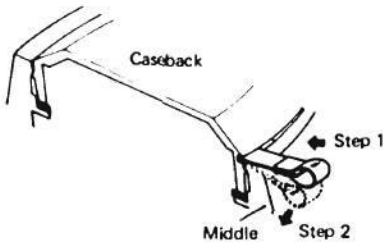

Insert the case opener in the opening notch and pry down to open.

How to reassemble

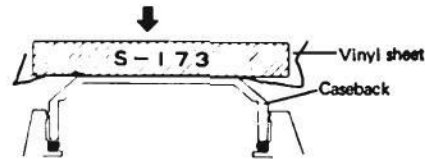

Push the glass in so that it is level using with the inserting disk (S-173)

Note: The supporting disk must fit close to the middle.

- Snap-out type (Projection of caseback snaps over the outside walls of the caseback at 12 o'clock and 6 o'clock positions)

How to disassemble

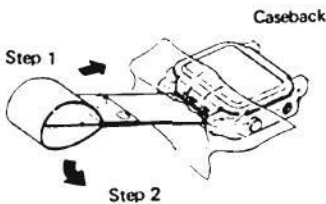

Insert the case opener into the opening notch at the 12 o'clock or 6 o'clock position.

Pry the caseback down to open.

Note: Do not pry open at any other position than the 12 o'clock or 6 o'clock position.

How to reassemble

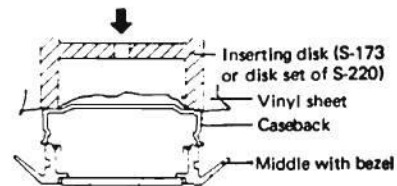

Use a glass inserting disk (S-173) to push the caseback on to the case keeping it level.

Note: Select a supporting disk which is a close fit to the middle.

4) Hook type

How to disassemble

Step 1

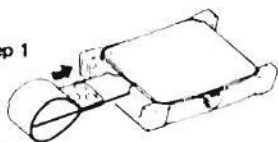

Step 2

Push the caseback in the direction opposite to the opening notch, and pry down to open.



Set one end first, and then push in the other end at an angle as illustrated.

Model with hooks at 12 o'clock and 6 o'clock positions: Set the caseback at the 12 o'clock position first, and then push in the 6 o'clock end.

Model with hooks at 3 o'clock and 9 o'clock positions: Set the 3 o'clock position first, and then push in the 9 o'clock position.

5) Leaf spring type

How to disassemble

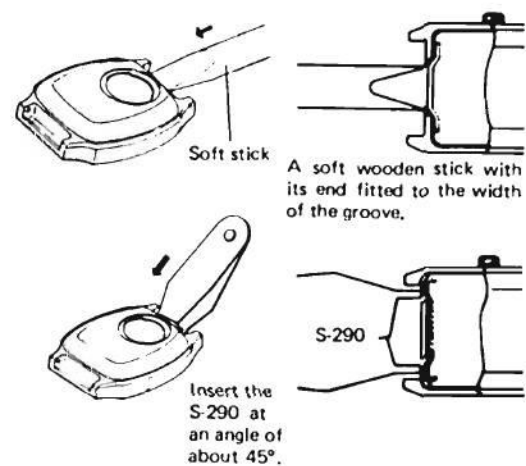

How to close

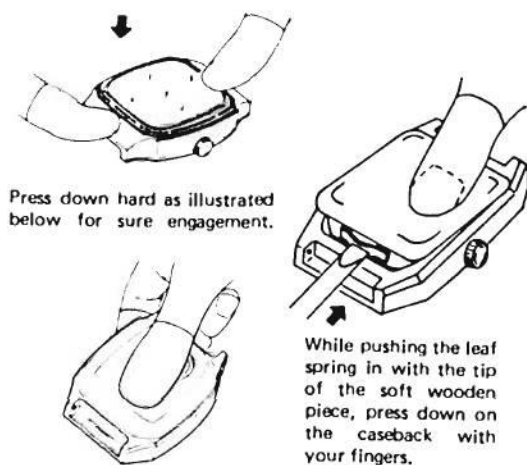

6) Bayonet type (The caseback has four notches and OPEN/CLOSE inscription)

The bayonet type caseback is classified into two types according to the open/close method.

Case opener

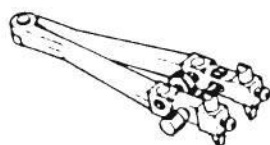

Case opener 194

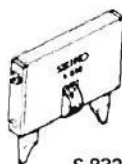

S-832

- When the inscription shows: CLOSE  OPEN.

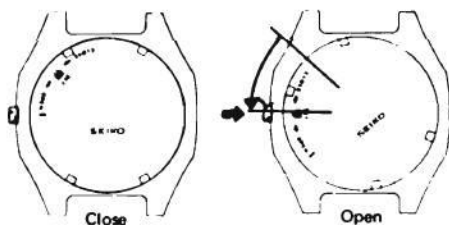

How to open

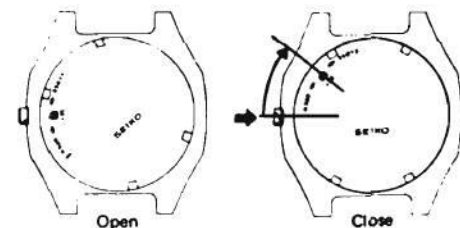

Turn the caseback toward "OPEN" direction by 45° so that the  mark comes in line with the crown to open the caseback.

How to close





Put the caseback so that its  mark comes in line with the crown, and turn the case back 45° toward "CLOSE" direction until the  mark comes in line with the crown.

- When the inscription shows: CLOSE  OPEN

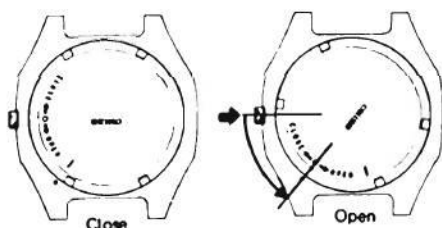

How to open

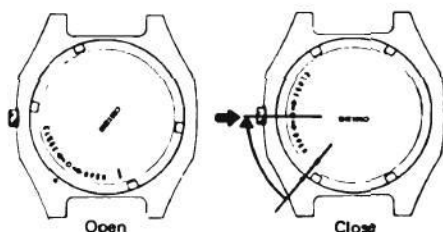

Turn the caseback toward "OPEN" direction by 45° so that the  mark of the caseback comes in line with the  mark of the middle to open the caseback.

How to close



Put the caseback on so that its  mark comes in line with the  mark of the middle. Then turn the caseback 45° toward the "CLOSE" direction until the  mark of the caseback comes in line with the crown.

- How to set the caseback gasket in position

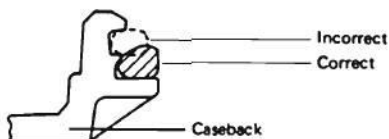

Note: Be sure to set the gasket in the right position.

(See the illustration on the left.)

- If the caseback is in position to remove and still does not come, remove it in the following way.

Middle with a groove

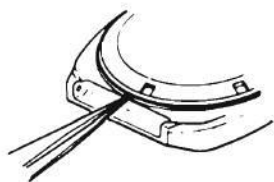

Middle without a groove

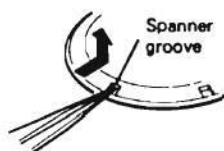

Note: Be careful not to turn the caseback excessively or the middle and caseback may be damaged.

7) Plastic gasket snap type

The new case back is used for the water resistant case which is fixed to the middle by the plastic gasket.

How to open

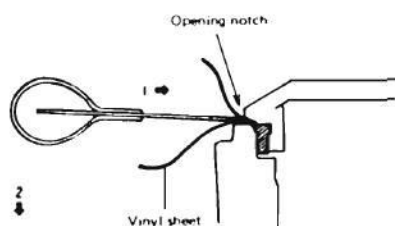

Put the tip of the case opener into the opening notch and pry it up as shown in the illustration.

How to close

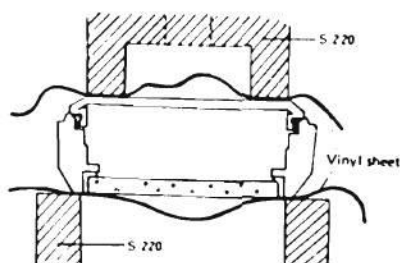

Push the case back with the case back gasket (plastic) in level by using the SEIKO tightening tool (S-220).

Note:

- Don't push the case back in alternately at one side with a finger. Otherwise, the gasket may not be set correctly, which will cause poor water resistance.
- Don't apply silicone grease to the plastic gasket so as not to weaken the fixing strength.

Remarks for case back gasket (plastic)

The case back gasket (plastic) is different from the existing rubber gasket in color (milk white) and property (elasticity, hardness, etc.), and is used for the same purpose as that of the latter.

When the case back is opened, for example, to replace the battery, check to see if scratches, breaks, or deterioration are seen on the gasket and, if any of these are found, be sure to replace it with a new one.

III-3. Battery hatch

There are the following types of battery hatch.

1) Screw type

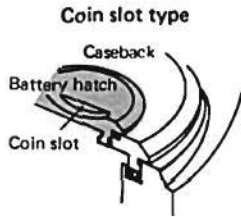

How to open and close

Turn the battery hatch clockwise or counterclockwise three to four times by using coin.

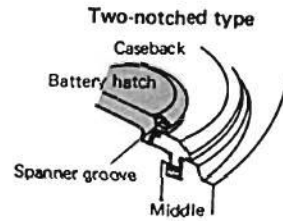

How to open and close

Turn the battery hatch clockwise or counterclockwise three to four times by using S-822.

2) Bayonet type (There are one Δ mark on battery hatch and two Δ marks on caseback.)

How to open

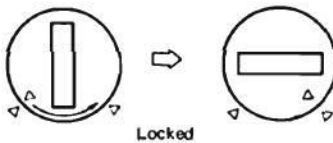

Turn the battery hatch in the arrow marked direction by about 90° to bring the mark Δ on the battery hatch comes in line with the right hand Δ mark on the caseback.

How to close

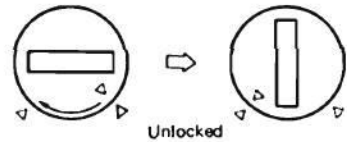

Turn the battery hatch in the arrow marked direction by about 90° so that the Δ mark on the battery hatch comes in line with the left hand Δ mark on the caseback.

• How to set the battery hatch gasket

There are two types; one in which a gasket is to be set on the battery hatch and the other in which a gasket is to be set on the caseback.

Gasket to be set in the battery hatch

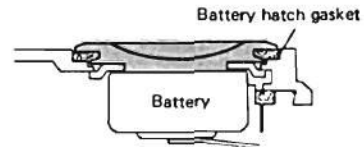

Gasket to be set in the caseback.

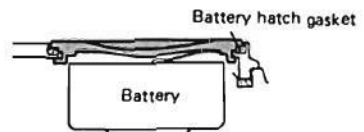
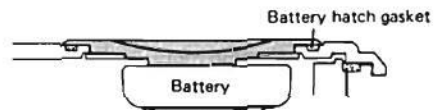

III-4. Button unit and crown unit

1. The following are constructions of button unit.

1-1) Button is fixed to the case by button spring clip

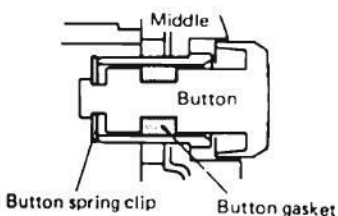

- How to remove the button
Remove the button spring clip with tweezers from inside of the middle, and push the button outward to remove.
 - How to set in the button
Push in the button from the outside, and set the button spring clip in the circular groove of the button from the inside.
- Note:** Some buttons use a button spring. Be careful not to lose it.

1-2) Button is not fixed to the case

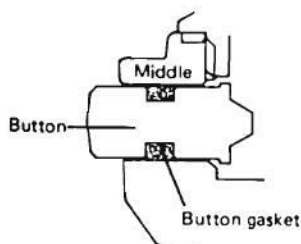

- How to remove the button
Push the button from the outside to remove it.
 - How to set the button
Push the button in position from the inside.
- Note:** Do not mistake the inside and outside portion of the button for each other, as the button will not operate.

1-3) Button is fixed to the case by case ring

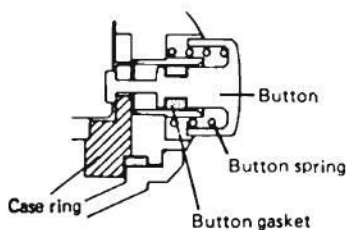

- How to remove the button
While pushing the button, remove the case ring, and then remove the button outward.
- How to set in the button
Push the button in from the outside. While pushing the button, set the case ring in position.

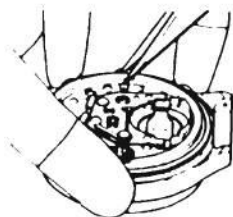

1-4) Button is fixed to the case by module

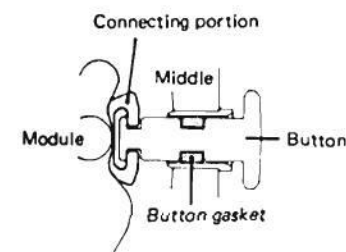

- How to remove the button
Push the button out.
 - How to set in the button
Push the button in from the outside, and reassemble the module so that the connecting portion of it is set in the groove of the button. (Be sure to check if the button is set in correctly by pushing it out.)
- Note:** If the caseback is closed when the button is out of position, the liquid crystal panel may break.

*Under normal disassembling, the button needs not to be disassembled. When the button is disassembled for some reason or other, be sure to check for gasket damage.

Replace the gasket with a new one if necessary, and apply silicone grease (500,000 c.s.).

III-5. Crown portion

The structural designs of the crowns are roughly classified into the following types.

1. Construction

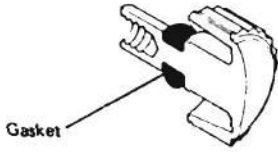
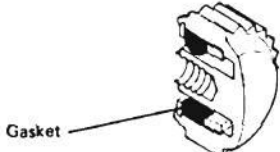
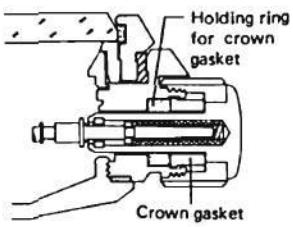
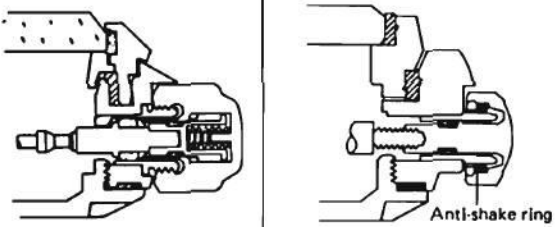
Type	Non water-resistant type and water-resistant type	
	 <p style="text-align: center;">Gasket</p>	 <p style="text-align: center;">Gasket</p>
	Reinforced water-resistant type (SPORTS 100)	
	Crown lock type	Anti-shake ring type
	 <p style="text-align: center;">Holding ring for crown gasket Crown gasket</p>	 <p style="text-align: center;">Anti-shake ring</p>

2. Checking and repairing

Checking point	Checking procedure	Repairing
1. Is the gasket in order?	1.1 Check for scratches and distortion. 1.2 Check for dust, lint and other contamination.	1.1 Replace the gasket or crown. 1.2 Clean with alcohol.
2. Can the crown be pushed in, pulled out, and turned without too much resistance?	2.1 Check whether the crown or stem is bent. 2.2 Check whether there is sufficient silicone grease. 2.3 Check whether the crown is positioned correctly.	2.1 Correct the deformed parts. If it can not be repaired, replace with new ones. 2.2 Clean with alcohol, and apply silicone grease (500,000 c.s.) all over the gasket slightly. 2.3 Adjust the stem position of the module in line with the center of the stem pipe. (In case of the screw type case back, the module may rotate when the case back is closed.)

<Replacement of gasket for the lock type crown> • To replace the crown gasket, follow the procedures below.

• How to remove the holding ring for crown gasket

Pry open the holding ring for crown gasket with tweezers and remove it. (Be sure to replace the holding ring for crown gasket with a new one.)

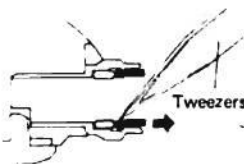

• How to set in the holding ring for crown gasket

Push a new holding ring for crown gasket in position with tweezers or with your fingers.

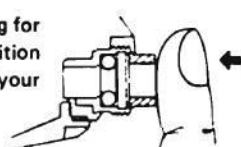

III-6. Disassembling and reassembling of the stem with crown.

1. How to remove the stem with crown from the case back side

Pull out the stem with crown while pushing the setting lever or setting lever axle.

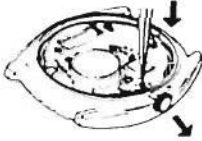

Put a screwdriver in between the two tips of the winding stem holder and turn it to open the tips of the winding stem holder. Then pull out the winding stem while turning the crown.

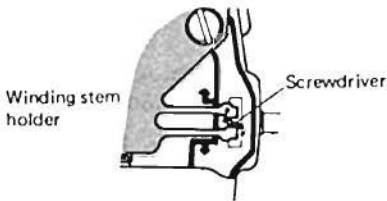

2. How to remove the stem with crown from the dial side

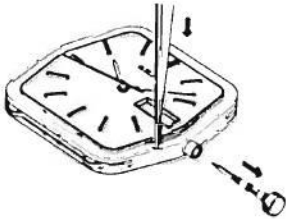

Pull out the crown until the lever for unlocking stem appears, and then pull out the crown with winding stem while pushing down on the lever for unlocking stem.

3. How to remove the joint stem

Turn the watch upside down (i.e., the dial side down), and turn the crown counterclockwise slowly. The winding stem will come off at the joint, and the module will drop down.

Note: Place a soft cloth under the watch when the joint stem is removed in order to protect the hands and other parts.

How to reassemble the stem with crown

Push the stem with crown into the stem pipe while turning it. (Be sure to check if the joint stem is set in correctly by pulling out the crown.)

If the stem with crown cannot be pushed in, push it in while pushing the setting lever axle or lever for unlocking stem.

How to reassemble

Put the joint stem into the stem pipe, and turn it counterclockwise to check for clicks. Then, push the joint stem into position. (Be sure to check if the joint stem is set in correctly by pulling out the crown.)





IV. LUBRICATION AND CLEANING

1. Lubricating Mark

In the Casing Guide by Type of Case Construction, the following marks indicate the types and quantities of oil to be applied.

Type of Oil	Quantity
<ul style="list-style-type: none"> ● Silicone grease (500,000 c.s.) ○ SEIKO watch oil S-6 	<ul style="list-style-type: none"> ○○○ Liberal quantity ○○ Normal quantity ○ Small quantity ⊗ Never lubricate

2. How to clean

Parts name	Cleaning	Drying	Solution	Remarks
Metallic parts (Case, case back, battery hatch, bezel, case ring, holding ring for dial)	Rinse or scrub with a soft brush 	Dry with warm air 	Benzine, trichloroethylene, trichlorotrifluoroethane S-3	If paint is used, wipe off dirt with a cloth.
Plastics parts (Case ring, holding ring for dial)	Do not clean	—	—	If soiled seriously, clean with a cloth soaked with a water diluted detergent.
Glass (Plastic, hardlex, clearlex (glare-free))	Do not clean. Wipe it with a clean cloth.	—	—	A special coating is provided on the inside surfaces of the glass for SPORTS 100. (Handle with care. Wipe the outer surfaces alone.)
Gasket (Plastic gasket, rubber gasket)	Rinsing (alcohol) 	Dry with cool air 	Alcohol	Max. rinsing time is 5 min.
Stem with crown Button	Rinse or scrub with a soft brush.	Dry with cool air	Alcohol	Max. washing time is 5 min.
Metal band	Rinse or scrub with a soft brush. 		Soapsuds	Be careful not to splash water against the watch.

V. WATER RESISTANT TEST, AND REPAIR

Described here are the checking method by the hydrostatic water resistant test and the repair method. This chapter will be helpful in checking the water resistant case (3 atmos.) and reinforced water resistant case (10 atmos.).

The symbol mark is inscribed on the caseback of the reinforced case as illustrated on the right.



Symbol mark

1. Checking method

● Remarks for water resistant test

- Don't use the water resistant testing machine where it is exposed to direct sunlight or high temperatures.
- First, do the water resistant test with the case alone. (Then, dry the case thoroughly and reassemble the module to the case.)

● Testing method

- 1) Fill the water tank of the water resistant testing machine with distilled water (or tap water), put a watch into the water tank, and then increase the tank pressure to the designated value.

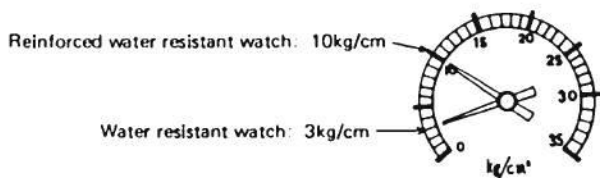

Note: Be careful not to increase the pressure more than required.

- 2) Leave the watch in the water tank for 5 min. at the specified pressure, and take out the watch. Then leave the watch on a hot plate heated up to approximately 40°C ±5°C (95°F to 115°F) for 15 min.

Note: • Wipe the watch thorough dry after taking it out from the water tank.

- Be sure to keep the temperature of the surface of the hot plate at 40°C ±5°C (95°F to 115°F).
The correct result can not be obtained if it is too high or too low.

3) Result





The water resistance is judged according to whether the inside surface of the glass becomes fogged by moisture condensation.

No fog: Normal

Fogged: Defective (Proceed to "Checking and repairing method".)

However, fogging for a very brief period due to internal moisture does not mean poor water resistance.

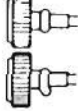
2. Checking and repairing methods

	Checking point	Checking procedure	Repairing procedure
Case back unit	1. Caseback and battery hatch	<ul style="list-style-type: none"> Loose caseback or dislocation of gasket out of place. Internal scratches, rust, dirt, etc. 	<ul style="list-style-type: none"> Reassemble the caseback or battery hatch. (Replace the gasket if it is found forced out.) Wipe off or replace. (If the caseback is found defective, replace the case with a new one.)
	2. Middle	<ul style="list-style-type: none"> Internal scratches, rust, stains, etc. 	<ul style="list-style-type: none"> Wipe off or replace.
	3. Gasket	<ul style="list-style-type: none"> Nicked, dust, lint, etc. 	<ul style="list-style-type: none"> Clean or replace gasket.
Crown and button portion	1. Relative position to case	<ul style="list-style-type: none"> Projects excessively 	<ul style="list-style-type: none"> Adjust
	2. Crown, button	<ul style="list-style-type: none"> Not centered 	<ul style="list-style-type: none"> Reassemble
	3. Stem pipe, button pipe	<ul style="list-style-type: none"> Bent, rusted, corroded, dirty 	<ul style="list-style-type: none"> Wipe off or replace.
	4. Gasket	<ul style="list-style-type: none"> Loose deformed scratches Dirt, dust, rust, etc. Dirt, dust, lint, deformed etc. 	<ul style="list-style-type: none"> Replace the case Clean Clean or replace. Replace gasket.
Glass unit	1. Glass and bezel	<ul style="list-style-type: none"> Halfway seating Critical scratches, chips, stains, etc. 	<ul style="list-style-type: none"> Press down tightly until it is properly seated. (If difficult to fit, reassemble.) Clean or replace.
	2. Middle	<ul style="list-style-type: none"> Critical scratches, corrosion, dirt, etc. 	<ul style="list-style-type: none"> Clean or replace case.
	3. Gasket	<ul style="list-style-type: none"> Dislocated Twisted and marred. Dirt, marred, dust and lint. 	<ul style="list-style-type: none"> Reassemble Reassemble or replace the gasket with a new one. Clean or replace.
	4. Plastic gasket	<ul style="list-style-type: none"> Reuse of used gasket Marred, dust and lint Deformed 	<ul style="list-style-type: none"> Replace Wipe off, or replace. Replace

When reassembling, be sure to remove dust, lint and other foreign objects and apply silicone grease to the gasket.

Notes: • The gasket needs periodic replacement (once every year or two).

- It is prohibitive to apply silicone grease to some gasket. Be sure to refer to the "Casing Guide by Type of Case Construction".

VI. CASE SERVICING GUIDE BY TYPE OF CASE CONSTRUCTIONS

F TYPE OF CASE CONSTRUCTION

F type of case construction

1. How to remove the glass

- Pry open the bezel
(If there are two opening notches, pry them up little by little alternately.)

(Example)

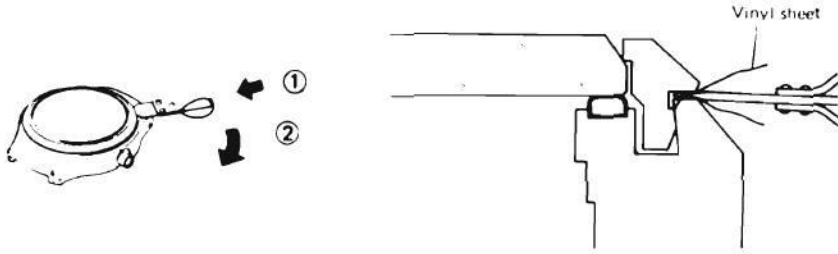

Note: Be sure to use a vinyl sheet so as not to scratch the case or bezel.

2. Disassembling direction for module

- Disassemble the module from the case back side

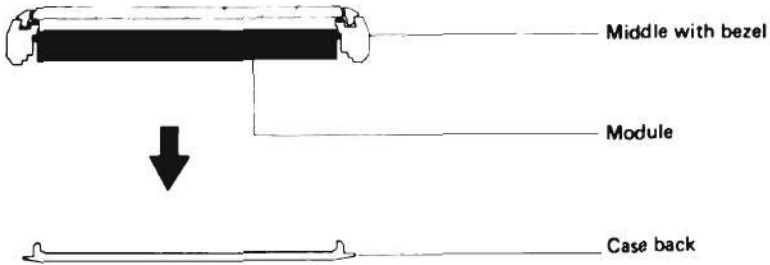

F0 type

1. Construction and remarks for repair

- How to reassemble the bezel
Reassemble the glass to the middle and then push the bezel in to the middle.

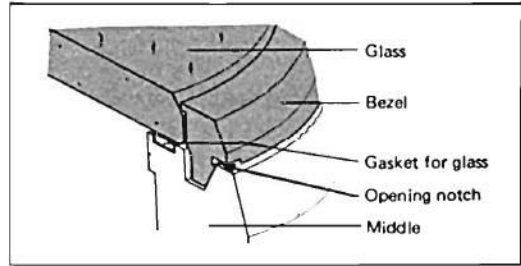
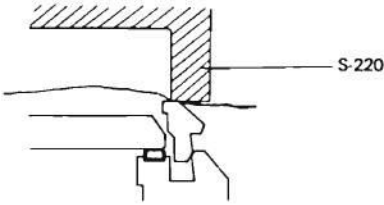

2. Disassembling and reassembling (typical example)

<Reassembling procedures >

<Reassembling procedures>

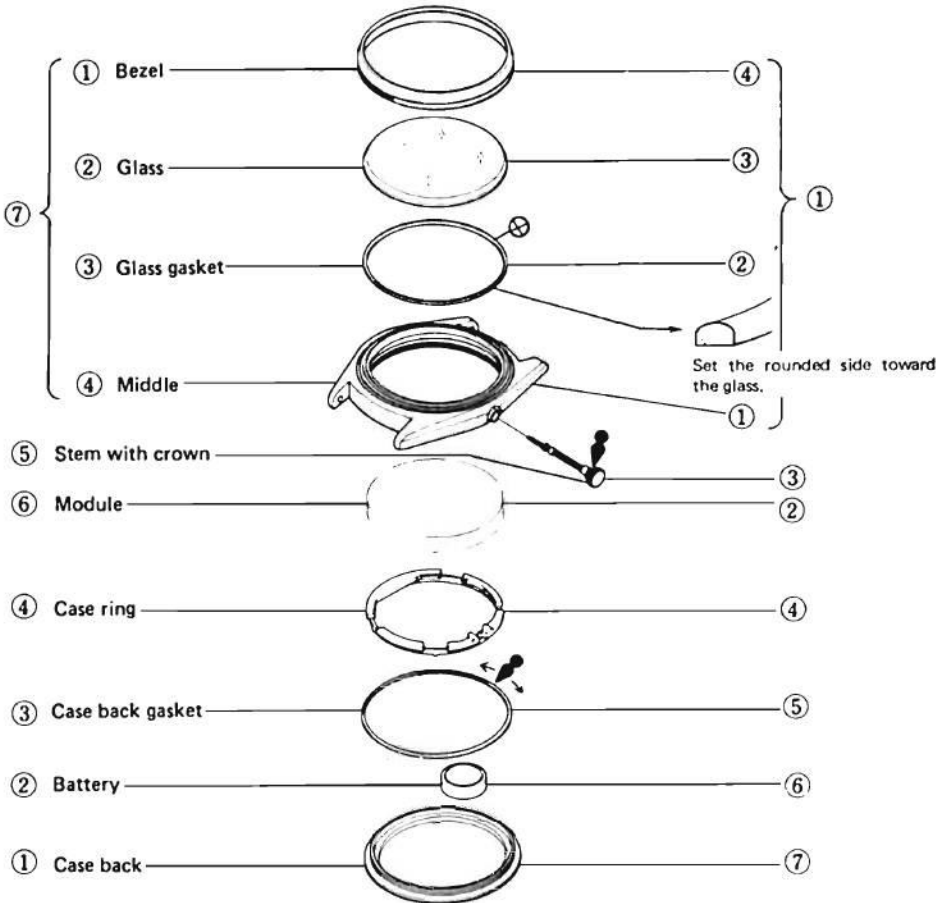

A TYPE OF CASE CONSTRUCTION

A type of case construction

1. How to remove the glass

- Push on the glass from inside directly with the inserting disk.

Ex.

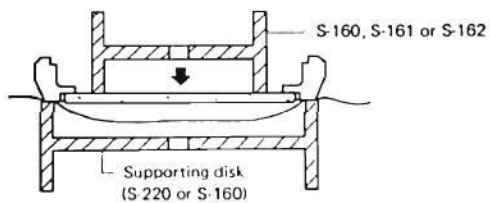

Correct

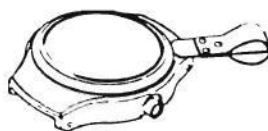

Incorrect

- Be sure to replace the glass gasket with a new one in order to maintain water resistance.

2. Disassembling direction of module

- Remove the module from the case back side

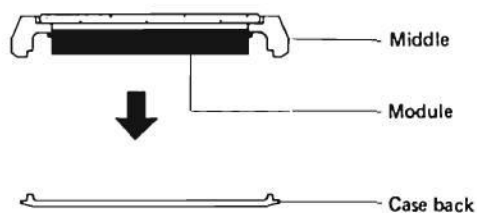

A0 type

1. Construction and remarks for repair

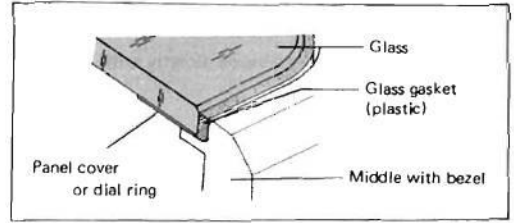

- How to remove the glass

Be sure to support the case with the supporting disk (S-220) so as not to touch the glass gasket.

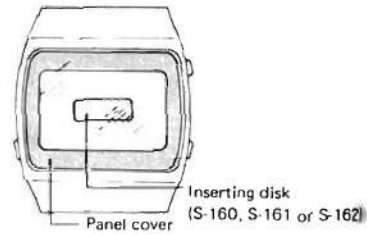
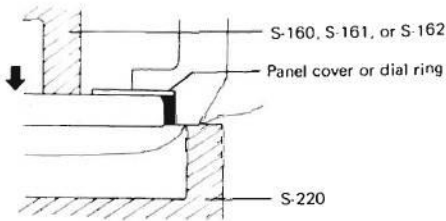

2. Disassembling and reassembling (typical example)

<Disassembling procedures>

<Reassembling procedures>

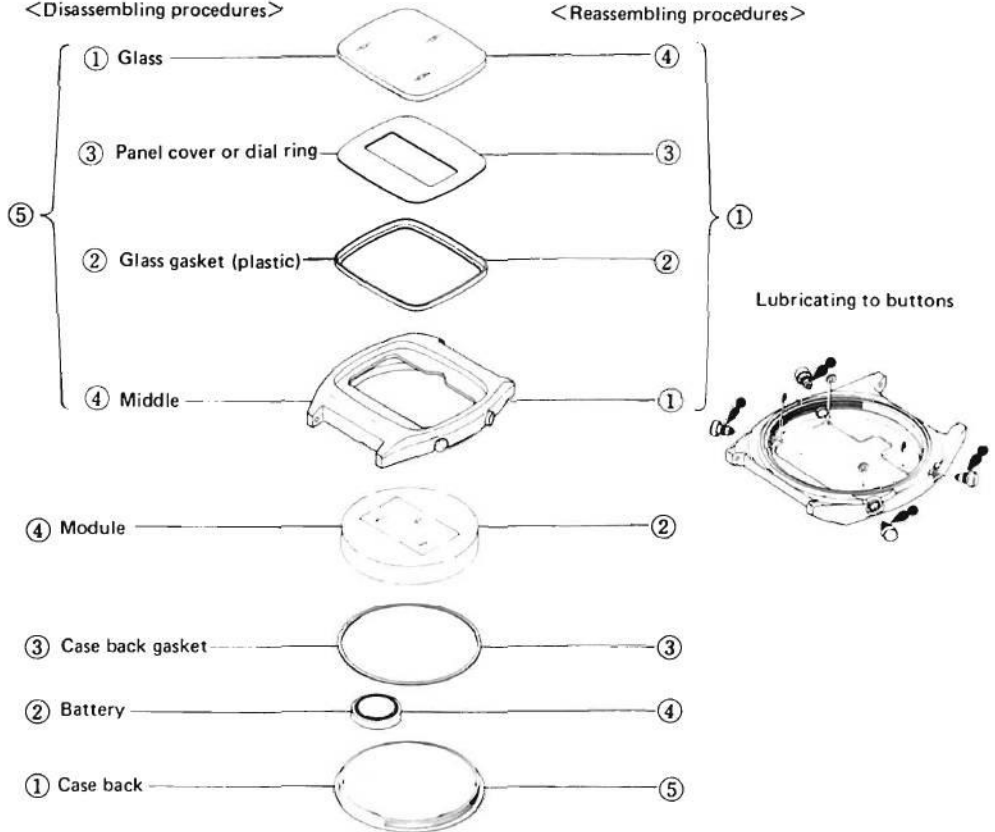

2-1 Disassembling and reassembling of the glass unit

- Notes:**
- For the model with a panel cover or dial ring, push on the glass directly so as not to touch the panel cover or dial ring.
 - Be sure to replace the plastic gasket with a new one in order to maintain water resistance.
 - When the glass is removed, be sure to check the top and bottom.
 - Some models which use a panel cover are different from others in the disassembling and reassembling procedures.

A design in which the position of the panel cover is determined by the gasket.

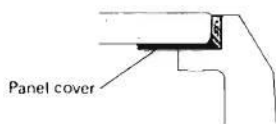

Disassembling procedures: Panel cover → Gasket

Reassembling procedures: Gasket → Panel cover

<Disassembling procedures>

1) Glass

- Push the glass from the inside so as not to touch panel cover or dial ring.

S-160, S-161 or S-162

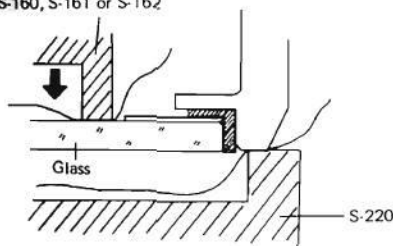

2) Plastic gasket for glass

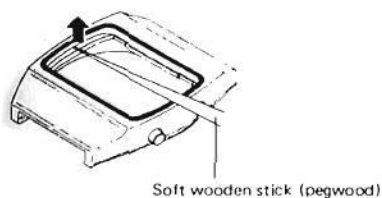

3) Panel cover or dial ring

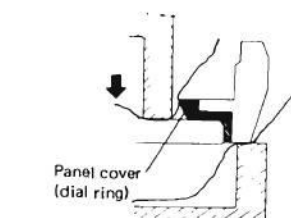

A design in which the position of the panel cover is determined by the middle.

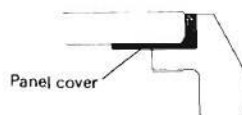

Disassembling procedures: Gasket → Panel cover

Reassembling procedures: Panel cover → Gasket

<Reassembling procedures>

1) Panel cover or dial ring

- 2) Glass gasket (plastic)
 - Be sure to replace it with a new one.

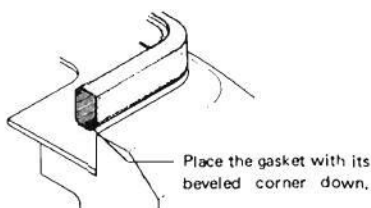

3) Glass

- Push the glass in level with the inserting disk.

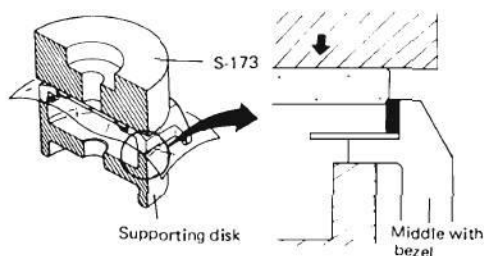

Note: Be sure to support the inside of middle with the supporting disk.

A1 type

1. Construction and remarks for repair

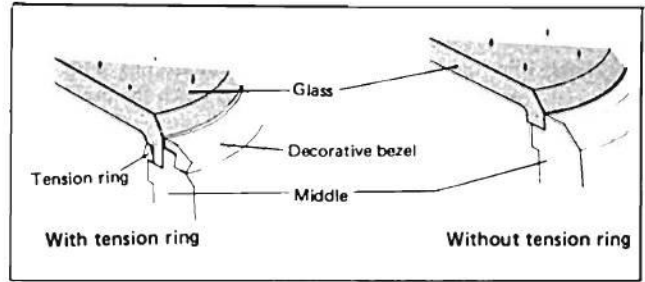

- How to reassemble the glass
Squeeze the glass to reassemble.

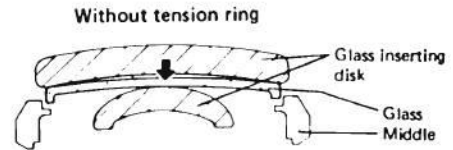
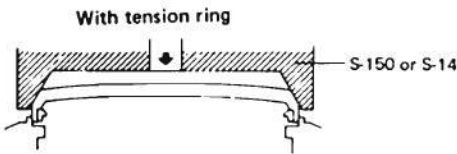

Note: When removing the glass, don't squeeze it with S-14.

2. Disassembling and reassembling (typical example)

<Disassembling procedures>

<Reassembling procedures>

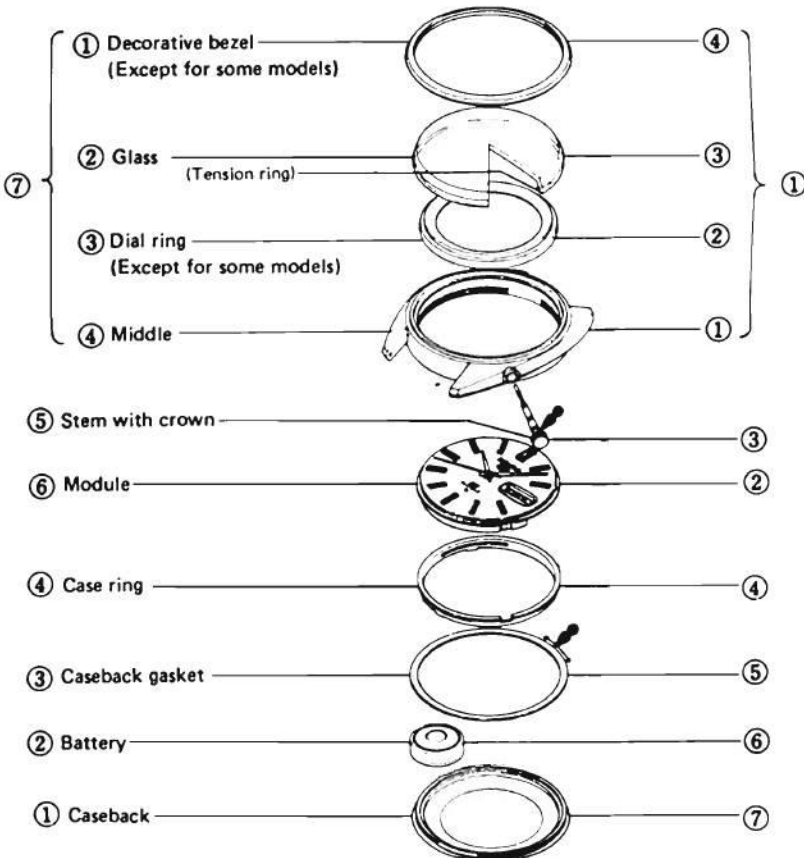

In case the dial ring is provided with a notch



2-1 Disassembling and reassembling of the glass unit

<Disassembling procedures>

Glass with a tension ring

1) Decorative bezel



2) Glass (with tension ring)

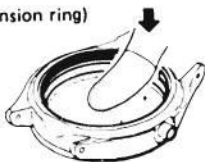

Push the glass at the center from inside.

- If the glass cannot be removed by pushing with fingers, use the SEIKO tightening tool (S-220) as illustrated below.

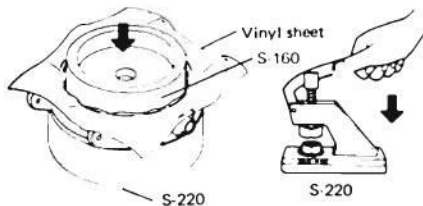

Glass without tension ring

1) Glass

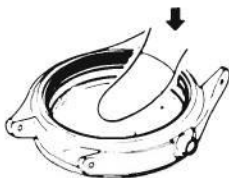

<Reassembling procedures>

Glass with a tension ring

1) Glass (with tension ring)

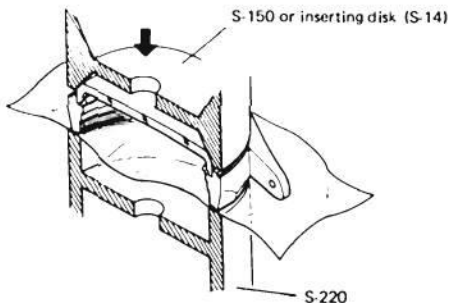

2) Decorative bezel

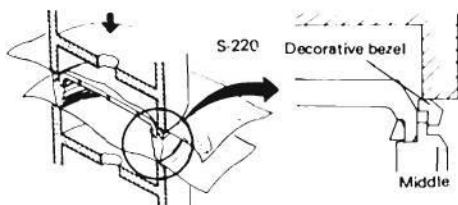

Glass without tension ring

1) Glass

Use a glass inserting tool to squeeze the glass for reassembling.

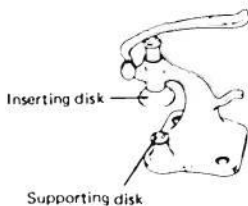

Tempered glass inserting tool

Size of the disk:

- Squeezing disk: Select one with the same diameter of the glass.
- Supporting disk: Select one a little smaller than the inside diameter of the glass.

A2 type

1. Construction and remarks for repair

- How to remove the glass

Be sure to support the case with the supporting disk (S-220) so as not to touch the glass gasket (plastic).

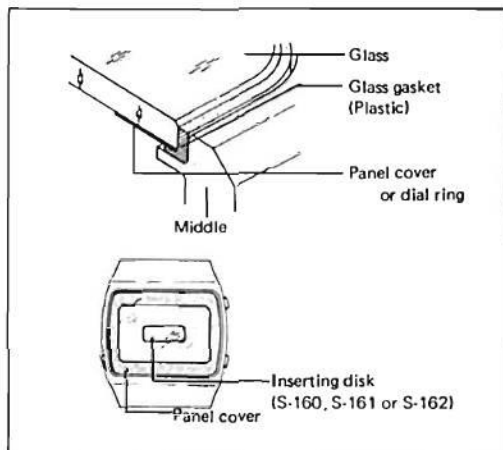
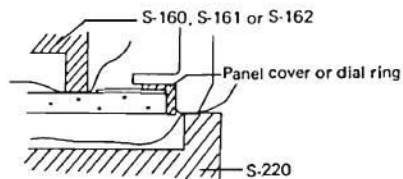

2. Disassembling and reassembling (typical example)

<Disassembling procedures>

<Reassembling procedures>

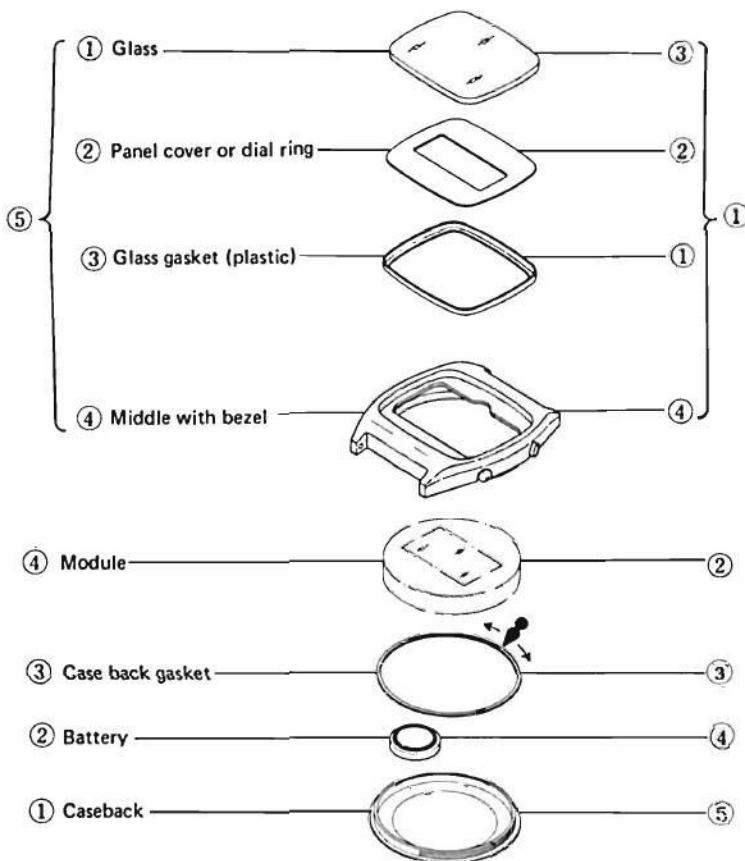

2-1. Disassembling and reassembling of the glass portion

<Disassembling procedures>

1) Glass

- Push the glass from inside so as not to touch the panel cover or dial ring.

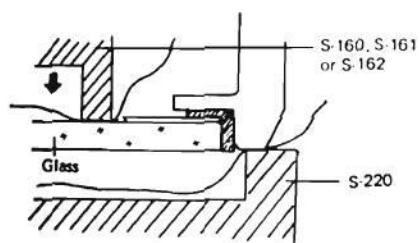

2) Panel cover or dial ring

3) Glass gasket (plastic)

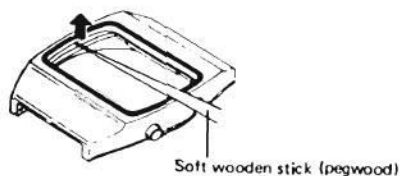

<Reassembling procedures>

1) Panel cover or dial ring

2) Glass gasket (plastic)

- Set the glass gasket (plastic) to the glass.
- Be sure to replace it with a new one.

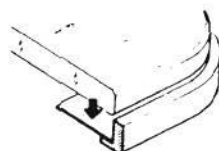

Note: Set the gasket and glass correctly.

3) Glass

- Push the glass in level with the inserting disk.

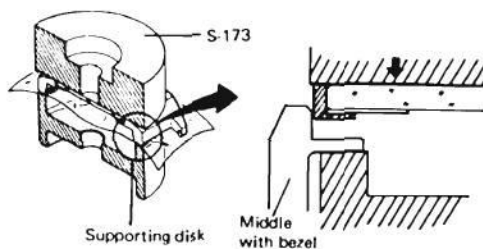

Note: Except for the models with a speaker frame, be sure to support the inside of the case at the inside flange.

A3 type

1. Construction and remarks for repair

- How to remove the glass
The glass unit can be removed and also the glass only can be removed.

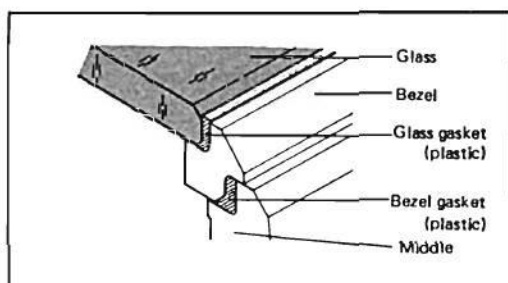

When only the glass is to be removed.

- Be sure to support the bezel with supporting disk, and push the glass.

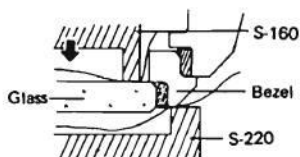

When the glass unit is to be removed.

- Be sure to support the middle with supporting disk, and push the bezel.

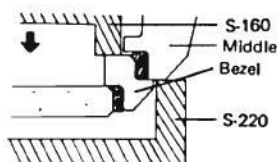

2. Disassembling and reassembling (typical example)

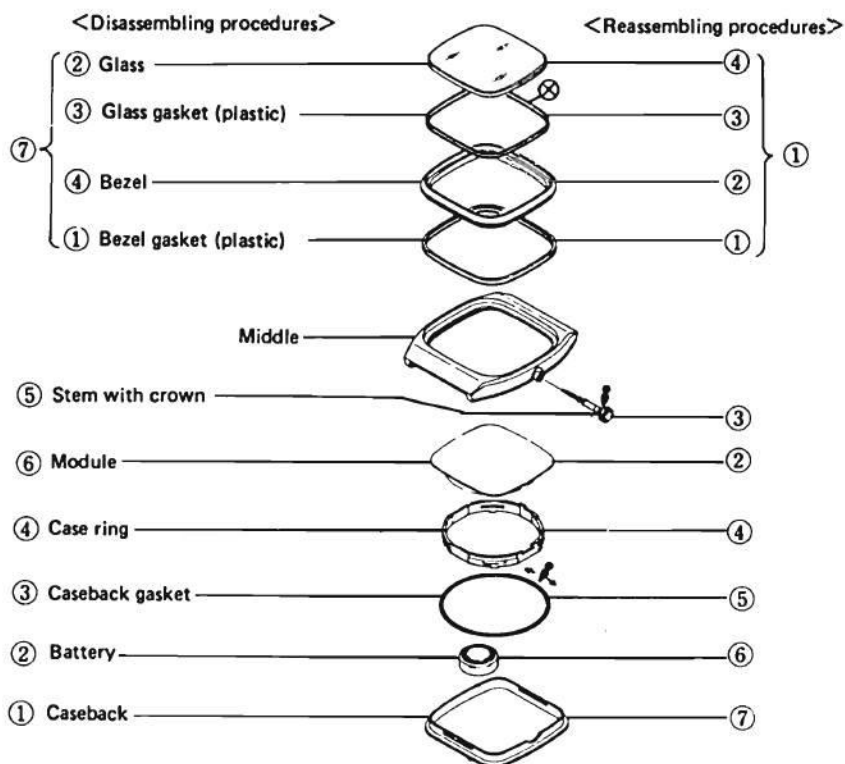

2-1. Disassembling and reassembling of the glass unit

<Disassembling procedures>

When only the glass is to be removed.

1) Glass

- Push on the glass directly to remove.

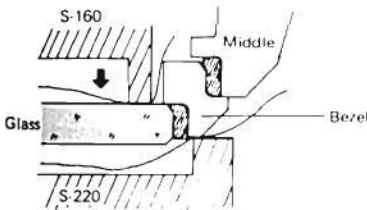

Note: Be sure to check the top and bottom of the glass.

2) Glass gasket (plastic)

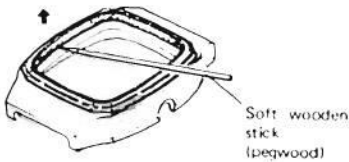

When the glass unit is to be removed.

1) Glass unit

- Push the bezel to remove

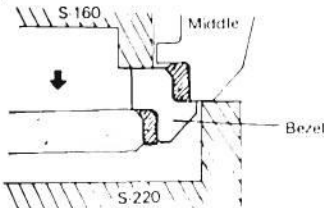

2) Bezel gasket (plastic)

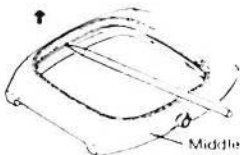

3) Glass

4) Glass gasket (plastic)

<Reassembling procedures>

When only the glass is to be reassembled.

1) Glass gasket (plastic)

2) Glass

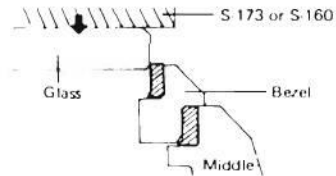

Note: Be careful not to mistake the top and bottom of the glass.

When the glass unit is to be reassembled.

1) Glass gasket (plastic)

- Be sure to replace it with a new one.

2) Glass

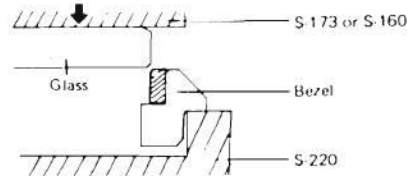

3) Bezel gasket (plastic)

- Be sure to replace it with a new one.

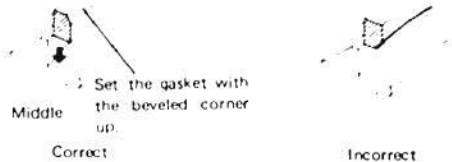

4) Glass unit

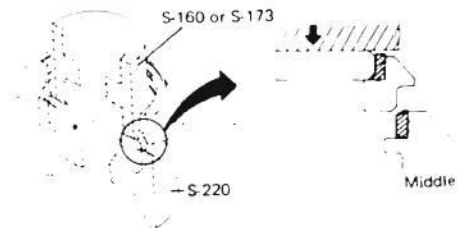

A4 type

1. Construction and remarks for repair

- How to remove the glass
The glass unit can be removed and also the glass alone can be also removed.

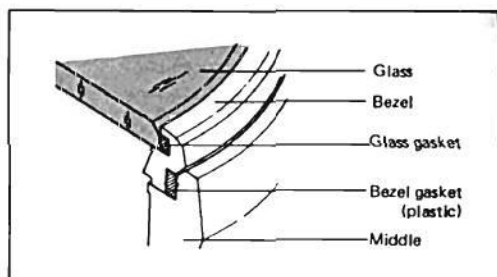

When only the glass is to be removed

- Be sure to support the bezel with supporting disk, and push the glass to remove.

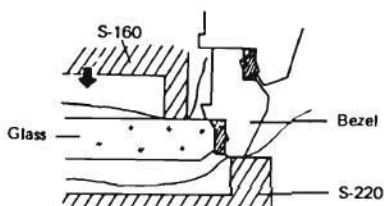

When the glass unit is to be removed

- Be sure to support the middle with the supporting disk, and push the bezel to remove.

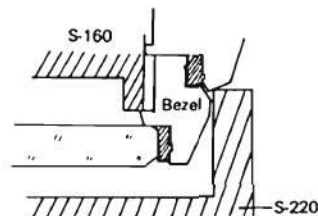

2. Disassembling and reassembling (typical example)

<Disassembling procedures>

<Reassembling procedures>

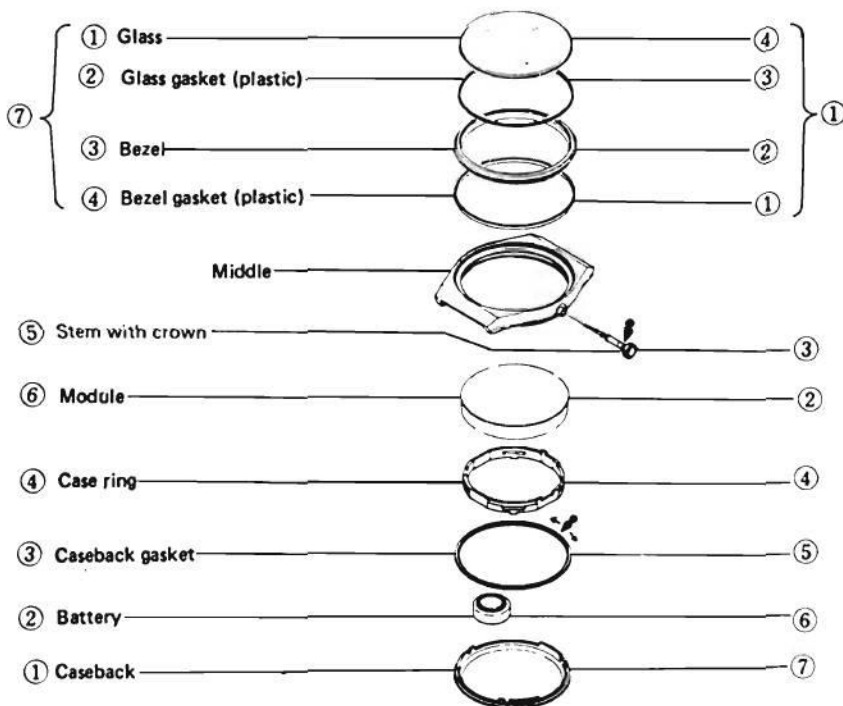

2.1. Disassembling and reassembling of the glass unit

<Disassembling procedures>

When only the glass is to be removed.

1) Glass

- Push the glass to remove

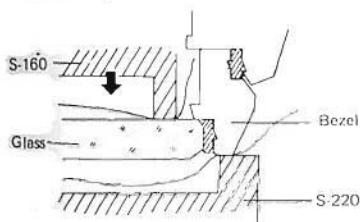

Note: Be careful not to mistake the top and bottom of the glass.

2) Glass gasket (plastic)

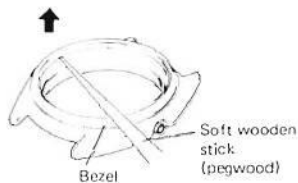

When the glass unit is to be removed.

1) Glass unit

- Push the bezel to remove

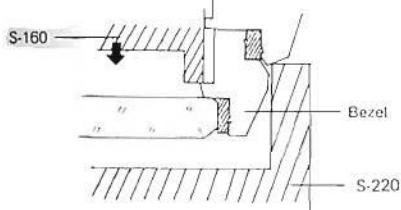

2) Bezel gasket (plastic)



3) Glass

4) Glass gasket (plastic)

<Reassembling procedures>

When only the glass is to be reassembled.

1) Glass gasket (plastic)

2) Glass

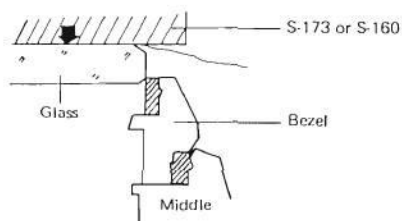

Note: Do not make a mistake between the top and bottom of the glass.

When the glass unit is to be reassembled.

1) Glass gasket (plastic)

- Be sure to replace the gasket (plastic) with a new one.

2) Glass

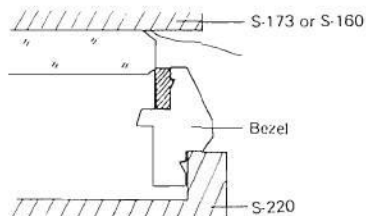

3) Bezel gasket (plastic)

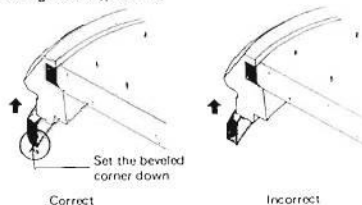

4) Glass unit

- Push the glass in level with inserting disk.

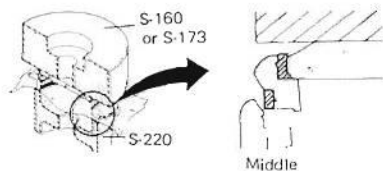

G TYPE OF CASE CONSTRUCTION

G type of case construction

1. How to remove the glass

- Push on the part which holds the glass from inside with an inserting disk in order to remove the glass.

Ex.

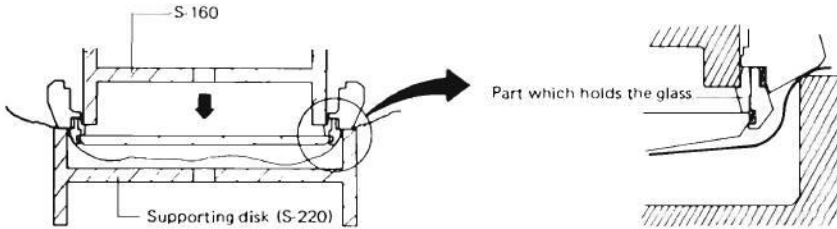

Note: Be sure to replace the plastic gasket with new one in order to maintain water resistance.

2. Disassembling direction of module

- Remove the module from the caseback side.

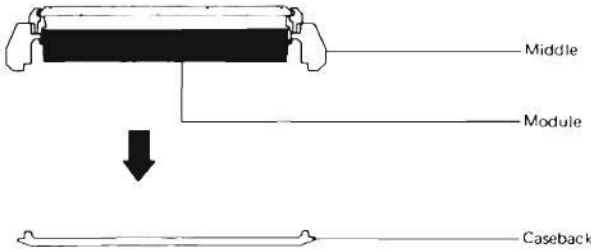

G0 type

1. Construction and remarks for repair

- How to remove the glass
First disassemble the glass unit, and then remove the glass.

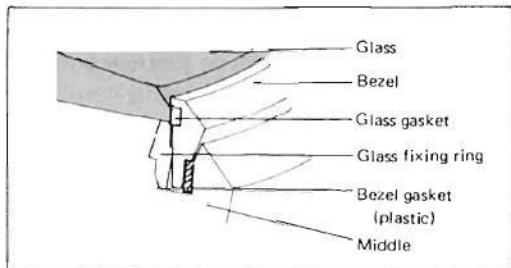

Push the glass fixing ring.

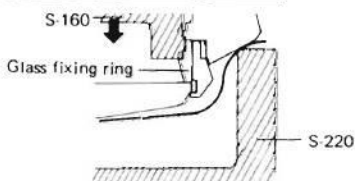

Push the glass from above.

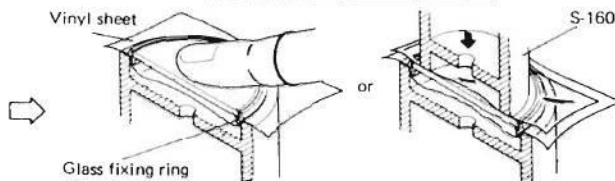

2. Disassembling and reassembling (typical example)

<Disassembling procedures>

<Reassembling procedures>

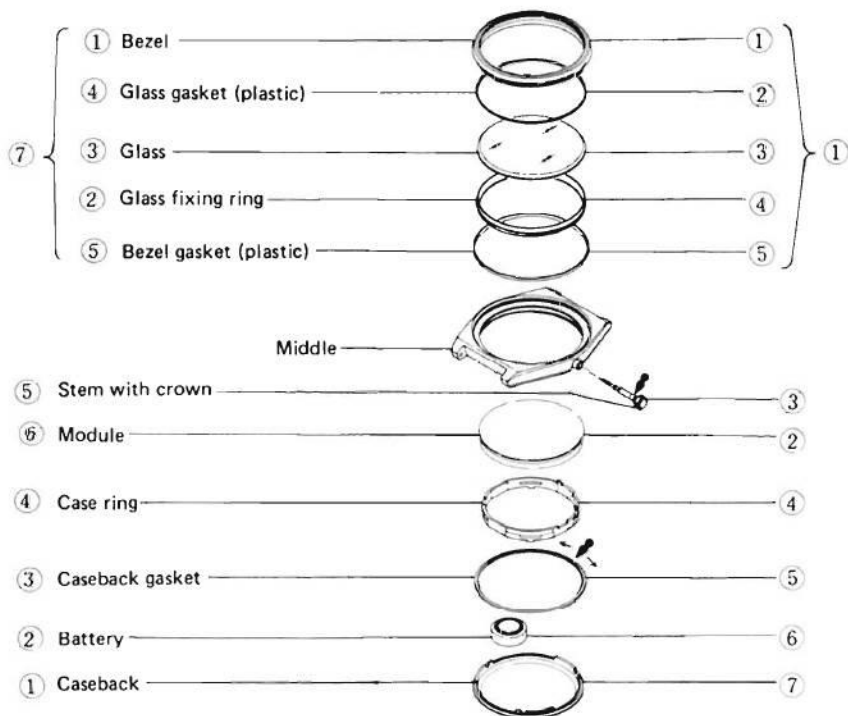

2-1. Disassembling and reassembling of the glass unit

<Disassembling procedures>

1) Glass unit

- Push the glass fixing ring from inside.

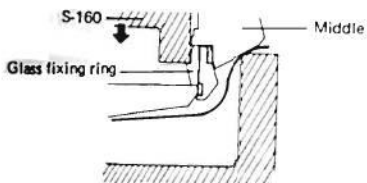

2) Bezel gasket (plastic)

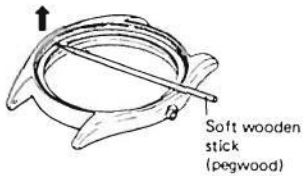

3) Glass (Glass fixing ring)

- Push the glass from outside.

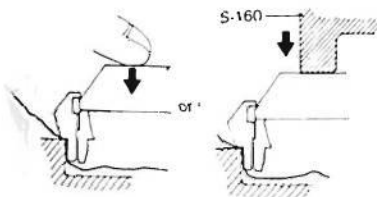

4) Glass gasket

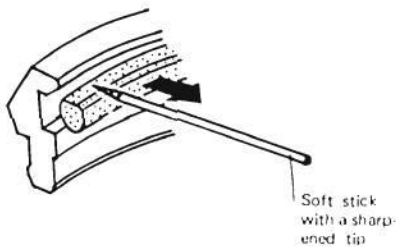

Note: Be sure to replace the glass gasket with a new one.

<Reassembling procedures>

1) Glass gasket

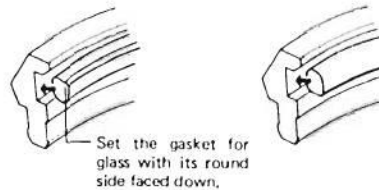

Correct

Incorrect

Note: Be sure to replace the glass gasket with a new one.

2) Glass (Glass fixing ring)

- Be sure to push the glass fixing ring with the inserting disk.

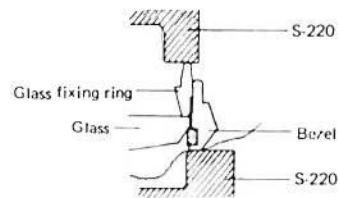

3) Bezel gasket (plastic)

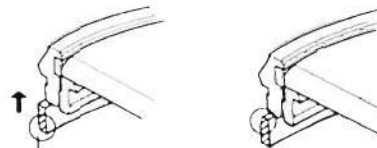

Set the plastic gasket with its beveled corner down.

Correct

Incorrect

4) Glass unit

- Set the glass unit by pushing the upper surface of the bezel. (See the illustration below.)

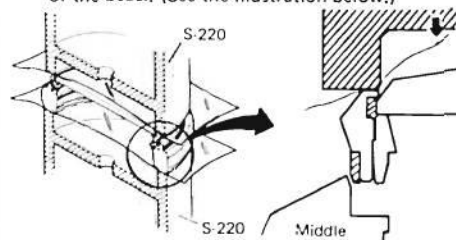

G1 type

1. Construction and remarks for repair

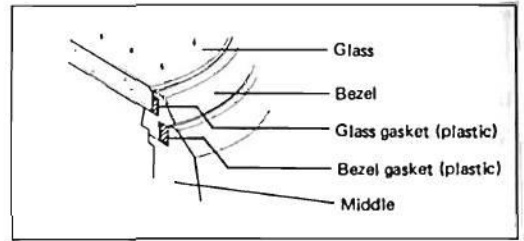

- How to remove the glass
First remove the glass unit, and then remove the glass.

Push the bezel

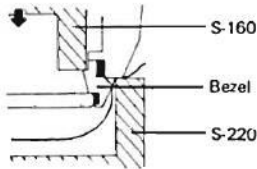

Push the glass from inside

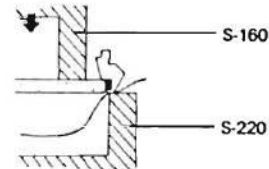

2. Disassembling and reassembling (typical example)

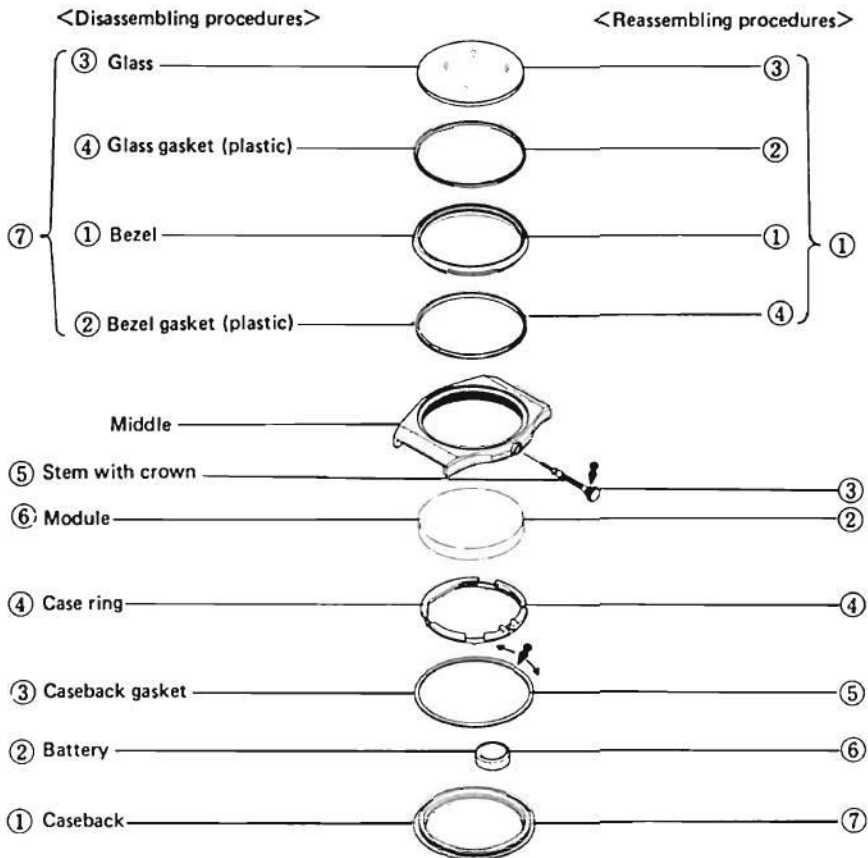

2.1. Disassembling and reassembling of the glass unit

<Disassembling procedures>

1) Glass unit

- Push the bezel from inside.

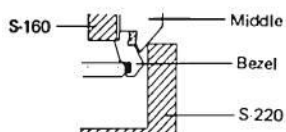

2) Bezel gasket (plastic)

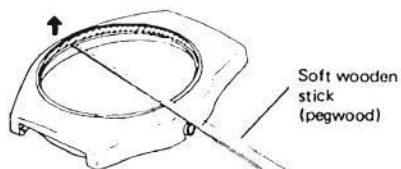

3) Glass

- Push the glass from inside.

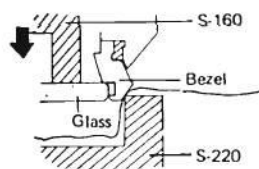

4) Glass gasket (plastic)

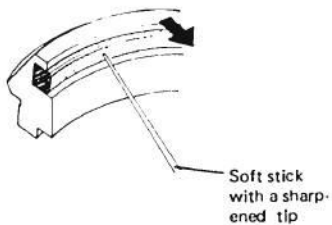

Note: Be sure to replace the glass gasket with a new one.

<Reassembling procedures>

1) Glass gasket (plastic)

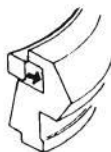

Note: Be sure to replace the glass gasket with a new one.

2) Glass

- Push the glass in level with the inserting disk.

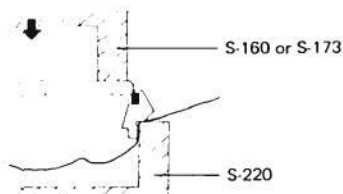

3) Bezel gasket (plastic)

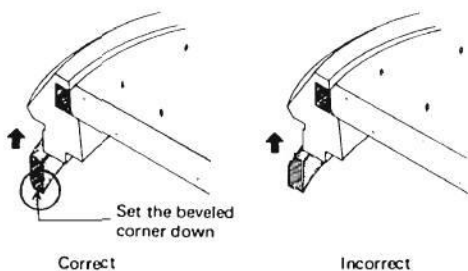

Note: Be sure to replace the bezel gasket with a new one.

4) Glass unit

- Set the glass unit by pushing the upper surface of the bezel with the inserting disk.

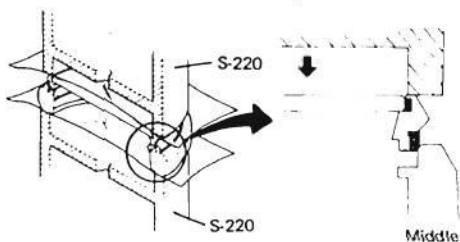

G2 type

1. Construction and remarks for repair

- How to remove the glass
When it is required to replace the glass, replace it as an entire glass unit.
(Do not replace glass alone)

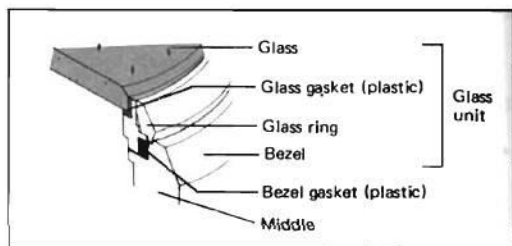

Push the glass ring.

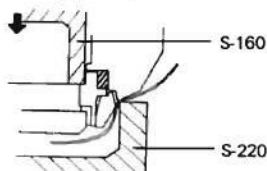

Correct

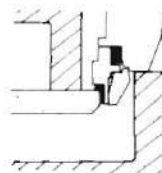

Incorrect

2. Disassembling and reassembling (typical example)

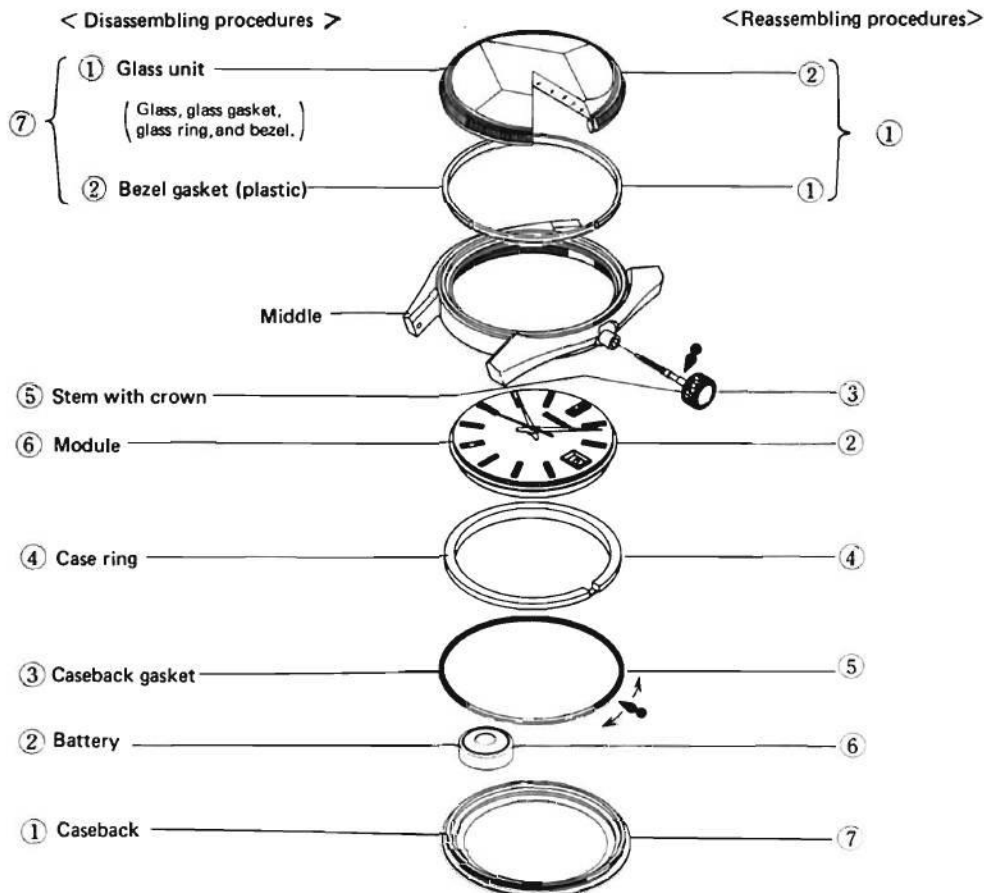

2-1. Disassembling and reassembling of glass unit

<Disassembling procedures>

1) Glass unit

- Push the glass ring from inside.

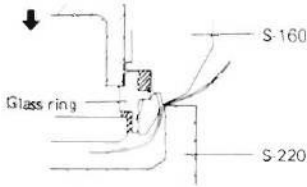

2) Glass gasket (plastic)

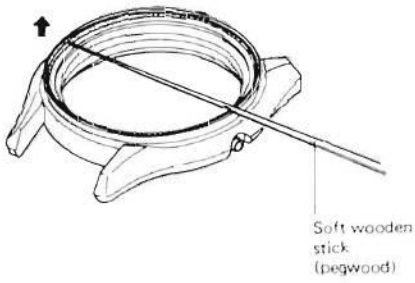

<Reassembling procedures>

1) Bezel gasket (plastic)

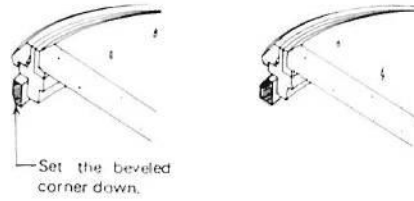

Correct

Incorrect

Note: Be sure to replace the bezel gasket with a new one.

2) Glass unit

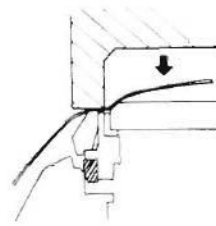

G3 type

1. Construction and remarks for repair

- How to remove the glass
First disassemble the glass unit, and then remove the glass.

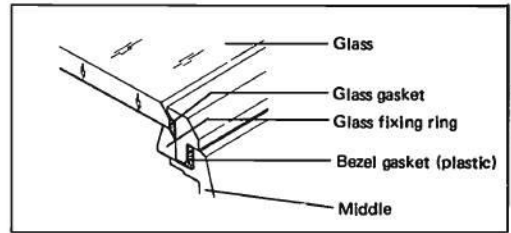

Push the glass fixing ring.

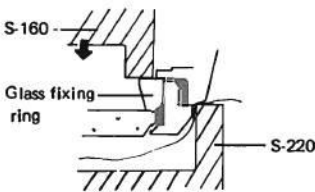

Push the glass from above.

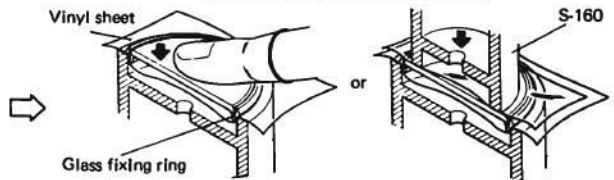

2. Disassembling and reassembling (typical example)

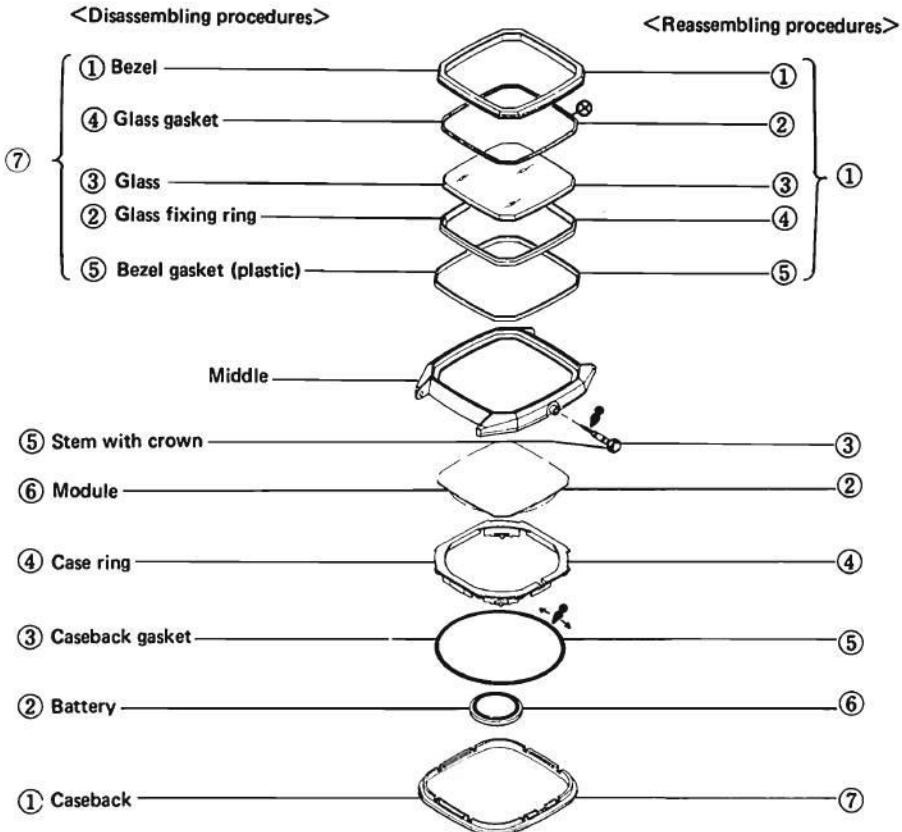

2-1. Disassembling and reassembling of the glass unit

<Disassembling procedures>

1) Glass unit

- Push the glass fixing ring from inside.

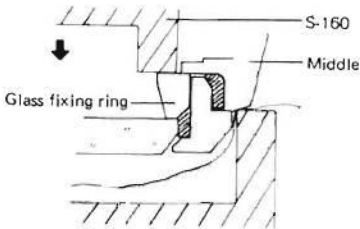

2) Bezel gasket (plastic)

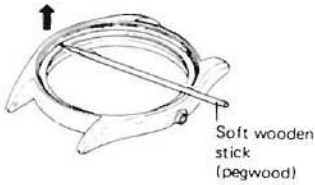

3) Glass

- Push the glass from above.

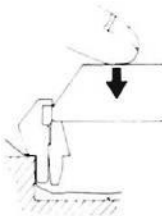

4) Glass gasket (plastic)

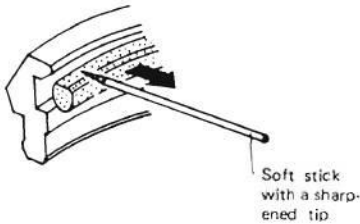

Note: When disassembling, do not use the same gasket again. Be sure to replace it with a new one.

<Reassembling procedures>

1) Glass gasket (plastic)

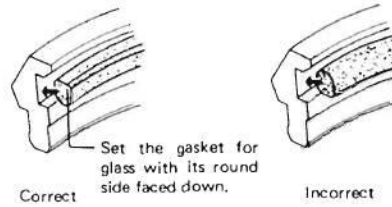

2) Glass

- Be sure to push in the glass by the glass fixing ring with the inserting disk.

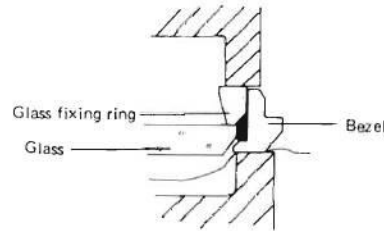

3) Bezel gasket (plastic)

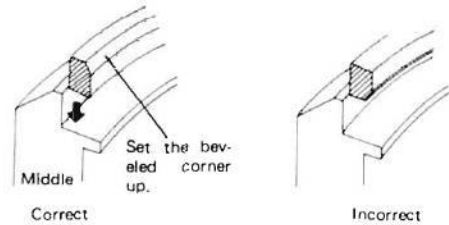

4) Glass unit

- Be sure to push the upper surface of the bezel.

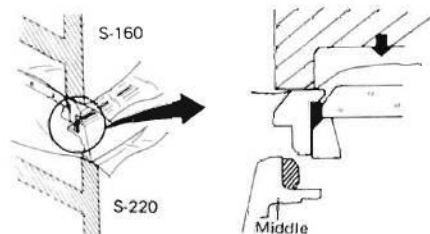

H TYPE OF CASE CONSTRUCTION

H type of case construction

1. How to remove the glass

- Push the upper surface of the glass with your hand.

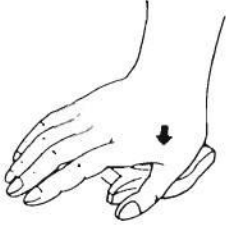

If the glass can not be removed with your hand, push it with the inserting disk.

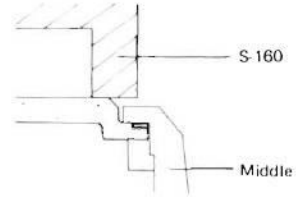

Note: Use the inserting disk slightly larger than the outside diameter of the glass.

2. Disassembling direction of module

- Remove the module from the caseback side.

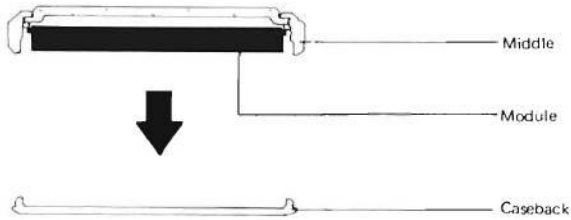

H0 type

1. Construction and remarks for repair

- How to remove the glass
Push the upper surface of the glass with your hand.

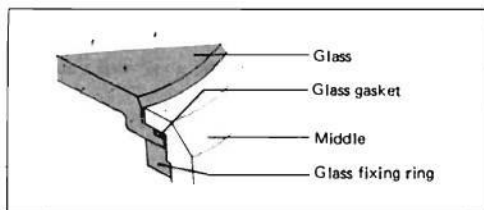

If the glass can not be removed with your hand, push it with the inserting disk as illustrated below.

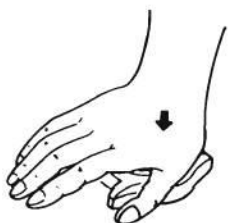

or

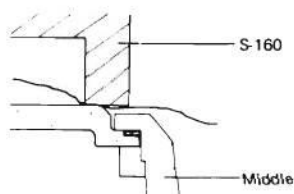

2. Disassembling and reassembling (typical example)

<Disassembling procedures>

<Reassembling procedures>

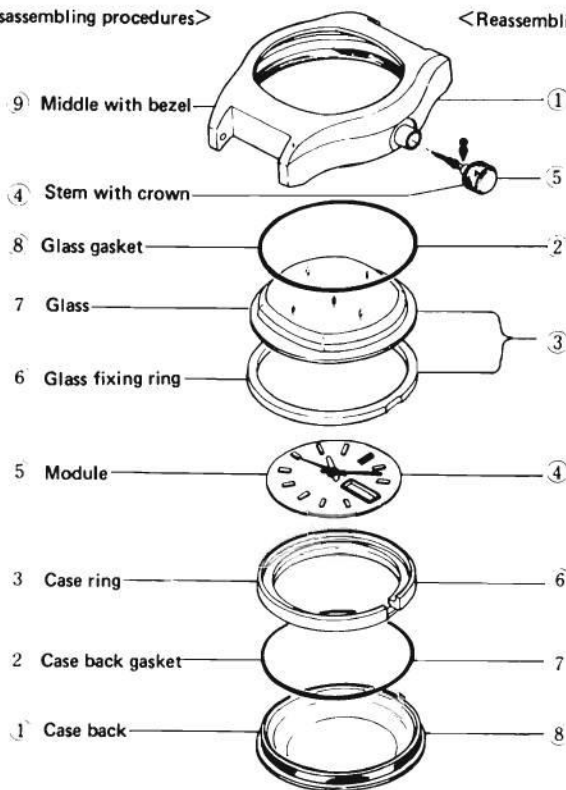

How to set the glass fixing ring

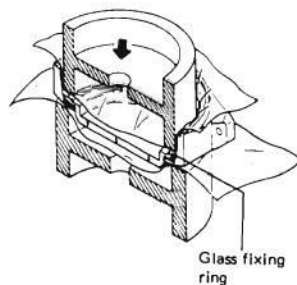

L TYPE OF CASE CONSTRUCTION

L type of case construction

1. How to remove the glass

- Remove the part which holds the glass, and then push the upper surface of the glass to remove.

Ex.

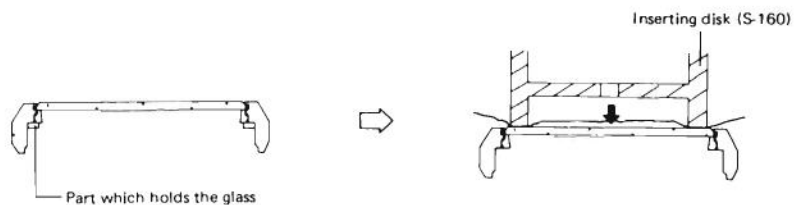

Note: Be careful not to deform the part which holds the glass when removing.

2. Disassembling direction of module

- Remove the module from the caseback side.

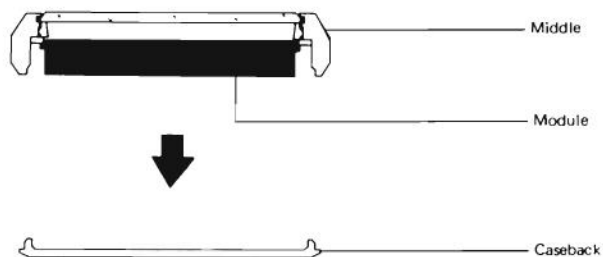

R TYPE OF CASE CONSTRUCTION

R type of case construction

1. Disassembling and reassembling of the glass

Disassembling procedure

Heat the adhered portion of the glass to the middle with bezel for about 10 minutes with a dryer and push it from inside with fingers to remove it.

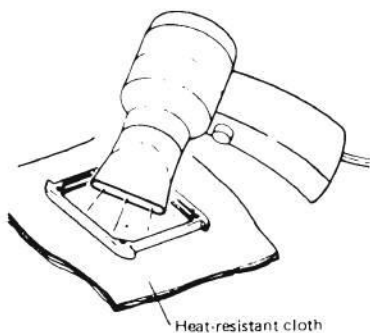

Keep the dryer about 1 cm above the case.

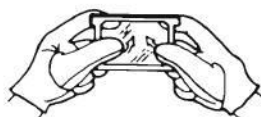

Wear cotton gloves on your hands.

- Note:**
- In case the glass is broken into pieces, remove the broken glass with a screwdriver after heating with hot air. Be careful not to injure your fingers.
 - The case will be hot. Be careful not to burn your fingers.
 - Do not heat the plastic glass.

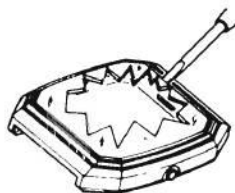

Reassembling procedure

Wipe off any contamination on the surface of parts to be adhered, and then apply SEIKO glass adhesive (S-310).

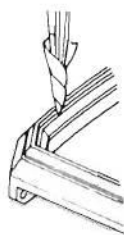

Clean with a cloth moistened with alcohol.

Remarks on adhering

- Adhering time
At normal temperature (24°C): approx. 24 hrs.
(75°F)
- At 40°C to 50°C : approx. 5 to 6 hrs.
(100°F to 120°F)
- An unequal mixing ratio of the base and the hardener weakens adhesion.

2. Disassembling direction of module

- Remove the module from the caseback side.

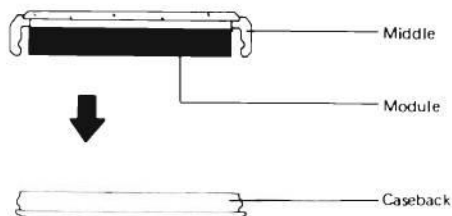

R0 type

1. Construction and remarks for repair

- How to remove the glass

Heat the adhered portion of the glass to the middle with bezel for about 10 minutes with a dryer and push it from inside with fingers.

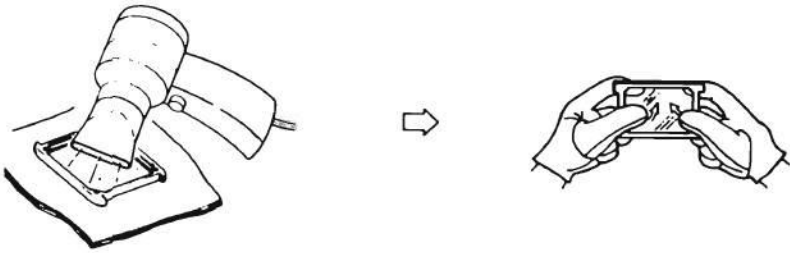
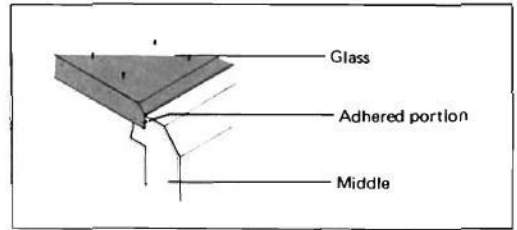

2. Disassembling and reassembling (typical example)

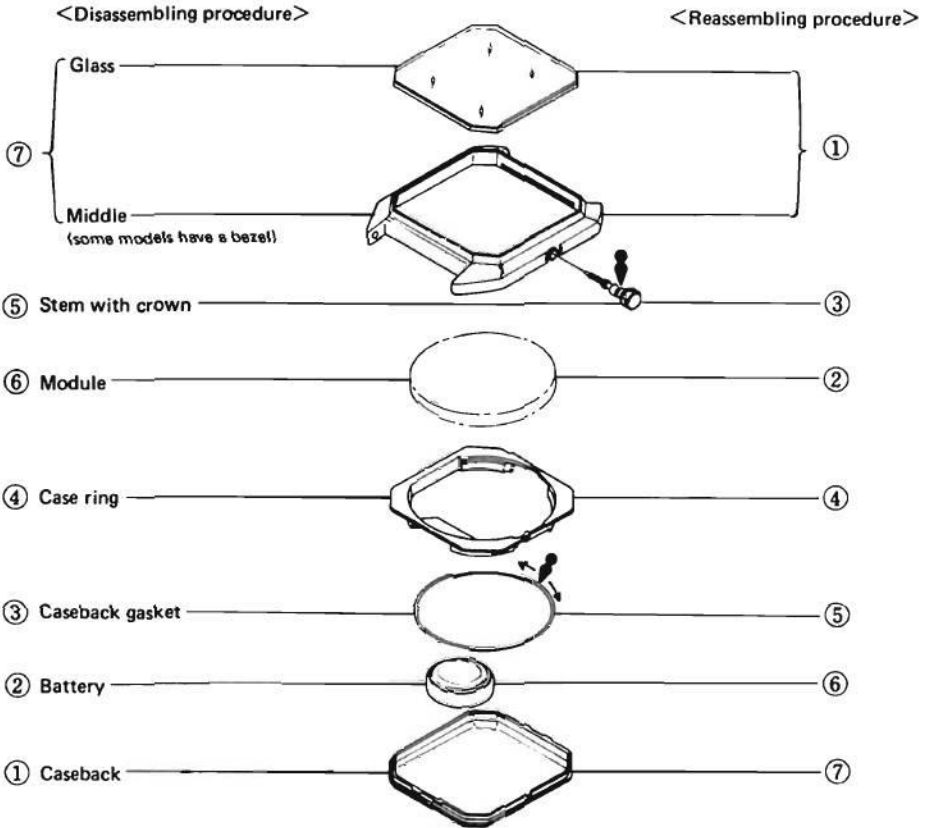

B TYPE OF CASE CONSTRUCTION

B type of case construction

1. How to remove the glass

- Pry open the bezel as shown in the illustration and remove the glass.

Ex.

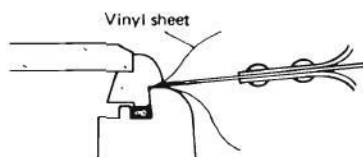
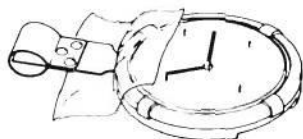

Note: When prying open the bezel, be sure to use a vinyl sheet or similar so as not to scratch the case.

2. Disassembling direction of module

- Remove the module from the dial side

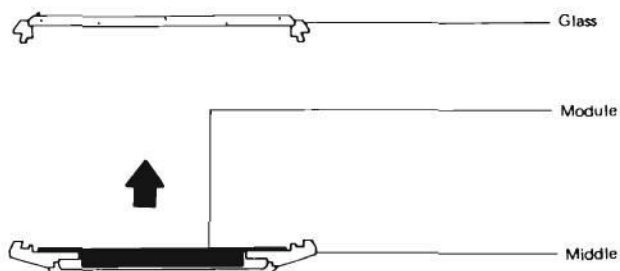

B0 type

1. Construction and remarks for repair

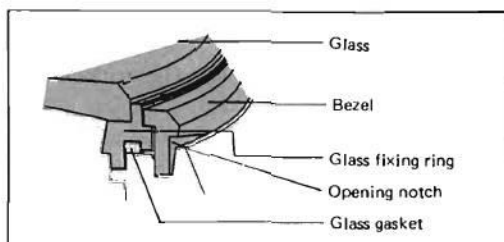

1-1. How to remove the glass

Pry open the bezel and remove the glass (with glass ring).

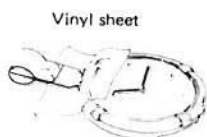

1-2. How to set the bezel

Push in the bezel with an inserting disk.

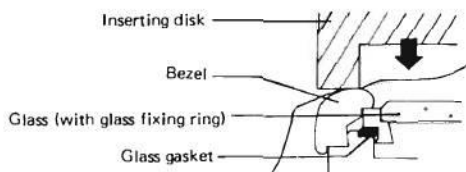

2. Disassembling and reassembling (typical example)

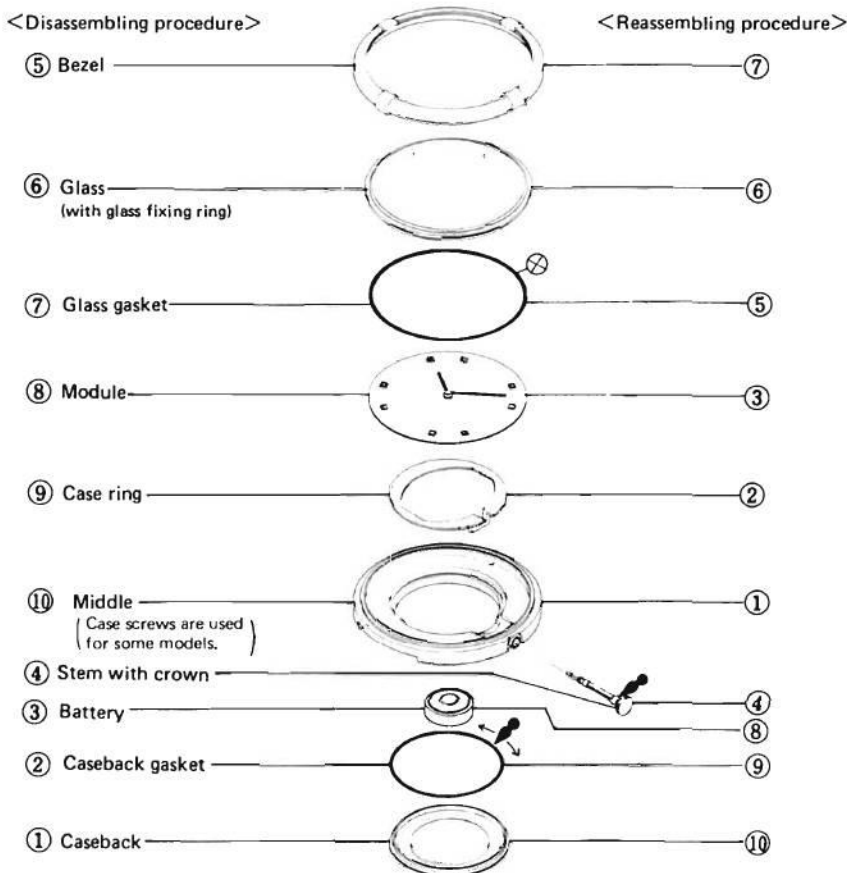

B1 type

1. Construction and remarks for repair

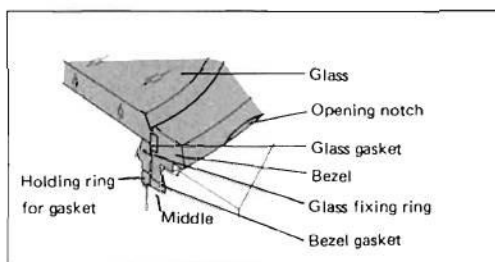

- How to remove the glass

First pry open the bezel (glass unit), and remove the glass.

Push the upper surface of the glass.



2. Disassembling and reassembling (typical example)

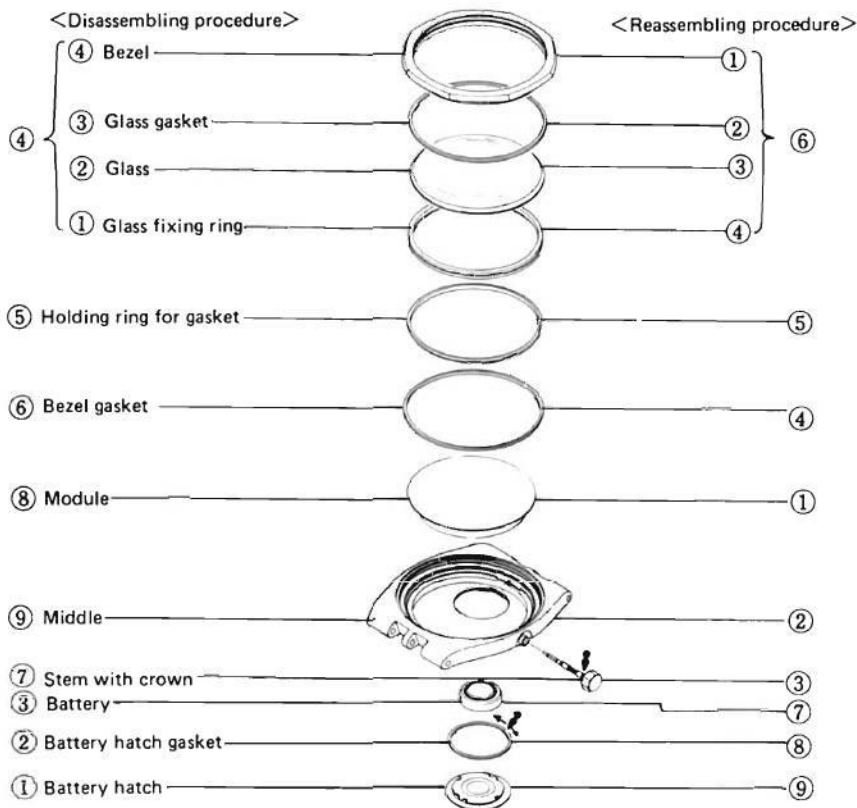

B2 type

1. Construction and remarks for repair

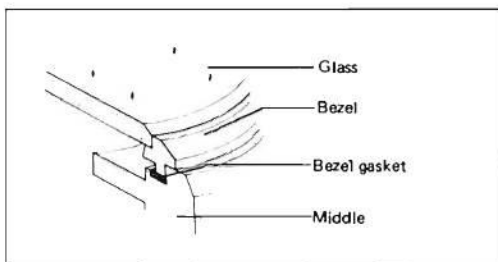

2. Disassembling and reassembling (typical example)

<Disassembling procedure>

<Reassembling procedure>

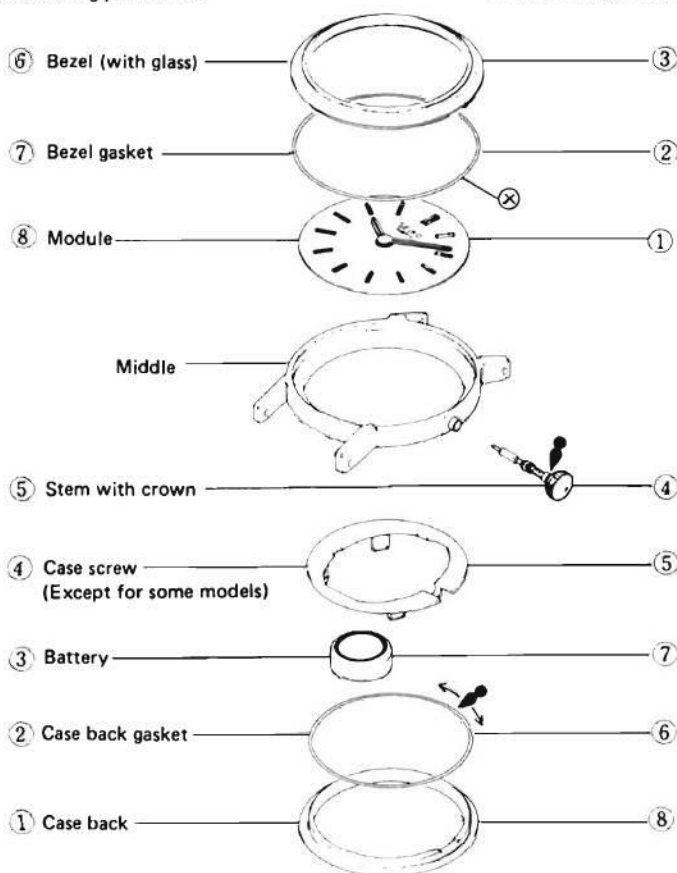

2-1. How to replace the glass

There are two types of case construction: one is to replace the glass only and the other is to replace the glass with bezel. In case only the glass is to be removed, follow the procedures instructed below.

<Disassembling procedure>

- 1) Heat the adhered portion of the glass to middle for about 10 minutes with a dryer (90°C ~ 100°C) (195°F ~ 210°F).

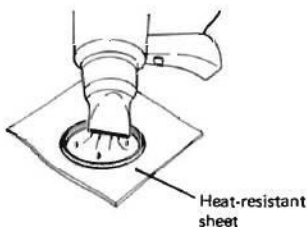

- Keep the dryer about 1 cm above the case when heating.

- 2) Push the glass with fingers and remove it.



- 3) Remove the adhesive

- Remove with a soft stick (like pegwood, bamboo spit).
- In case the glass is broken into pieces, remove the broken glass by prying it up with a screwdriver after heating with hot air.



<Reassembling procedure>

- 1) Wipe off any contamination on the surface of the bezel to be adhered with a cloth moistened with alcohol.

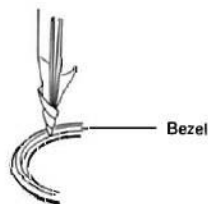

- 2) Apply SEIKO glass adhesive (S-310) slightly to the surface to be adhered so that it is uniformly coated.

- 3) Reassemble the glass

Note: Be sure to set the glass correctly so that it is completely down and not tilted.

- Remarks for adhering
- Adhering time
 - At normal temperature (24°C): about 24 hrs. (75°F)
 - At 40°C to 50°C : 5 to 6 hrs. (105°F to 120°F)
- An unequal mixing ratio of the base and the hardener weakens adhesion.

B3 type

1. Construction and remarks for repair

• How to remove the glass

Pry open the bezel (glass unit), and remove the glass.

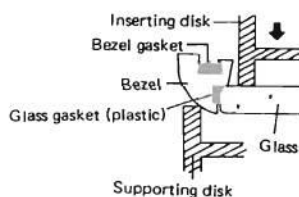
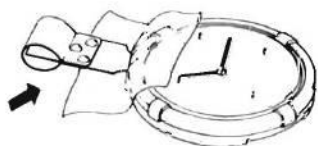
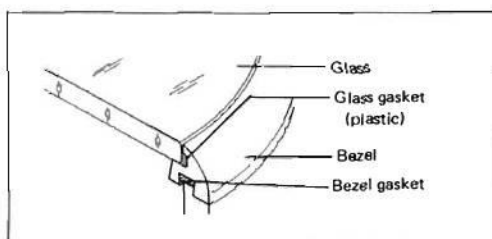

2. Disassembling and reassembling (typical example)

<Disassembling procedures>

<Reassembling procedures>

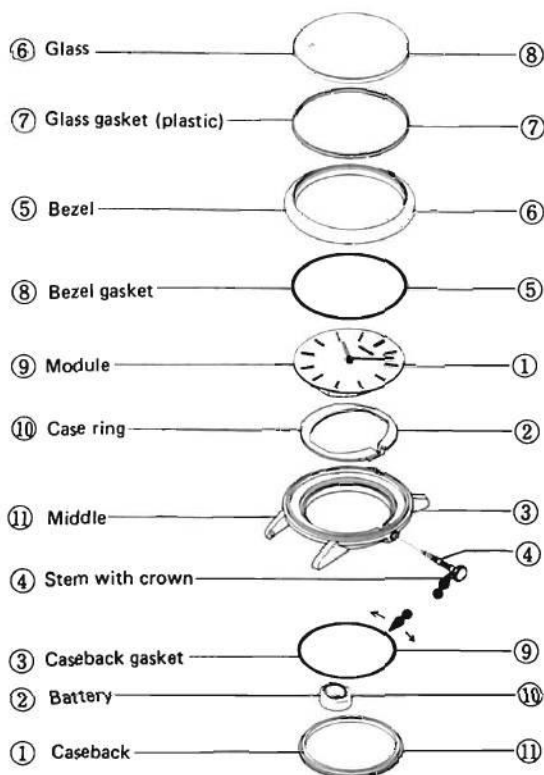

Note: Some models are provided with a case screws.

2-1. Disassembling and reassembling of glass unit

<Disassembling procedures>

1) Bezel

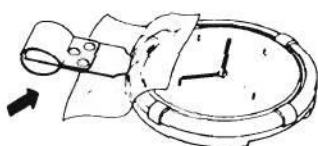

2) Glass

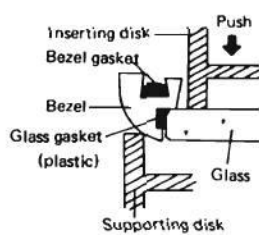

3) Bezel gasket

<Reassembling procedures>

1) Glass gasket (plastic)

2) Glass

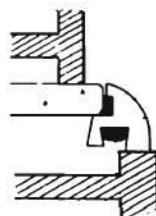

3) Bezel

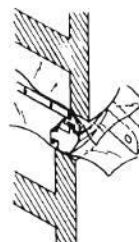

E TYPE OF CASE CONSTRUCTION

E type of case construction

1. How to remove the glass

- Push the glass from inside and remove it.

Ex.

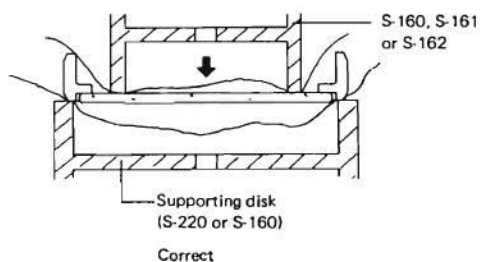

Incorrect

- Notes:**
- Be sure to replace the glass gasket (plastic) with a new one in order to maintain the water resistance.
 - When the glass is removed, make sure to differentiate between top and bottom.

2. Disassembling direction of module

- Remove the module from the dial side.

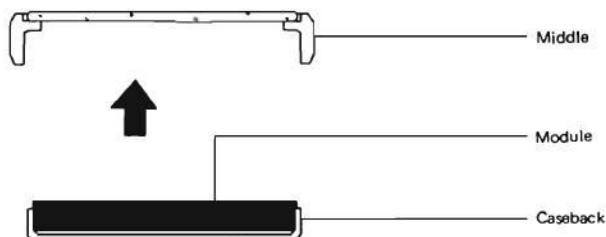

E0 type

1. Construction and remarks for repair

- How to remove the glass
Push the glass directly with the inserting disk from inside.

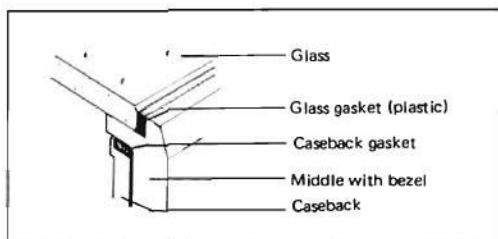
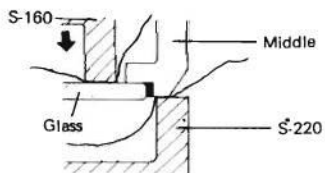

Note: In case a bezel is provided, be sure to support the bezel.

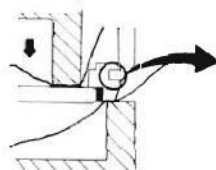

The bezel is fixed to the middle. Do not remove it.

2. Disassembling and reassembling (typical example)

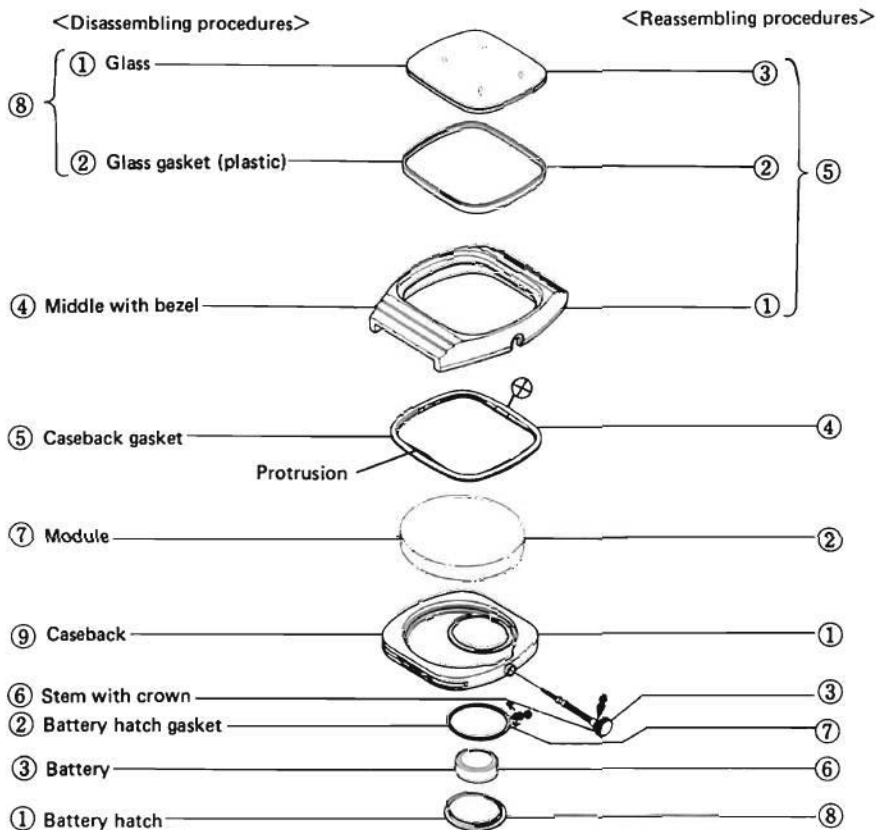

2-1. Disassembling and reassembling of glass unit

<Disassembling procedures>

1) Glass

Be sure to support the middle with bezel with the supporting disk (S-220) so as not to touch the plastic gasket.

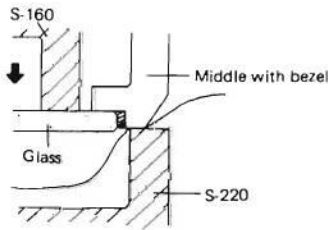

Note: Make sure to differentiate between top and bottom of the glass

2) Glass gasket (plastic)

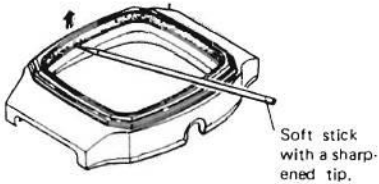

<Reassembling procedures>

1) Glass gasket (plastic)

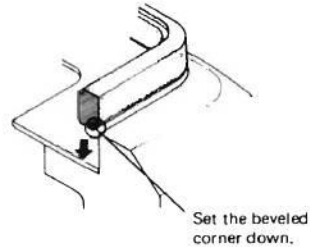

2) Glass

- Push the glass in level.

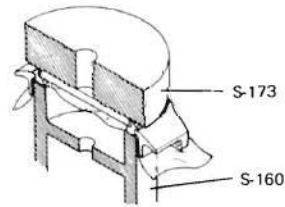

C TYPE OF CASE CONSTRUCTION

C type of case construction

1. How to remove the glass

- Push the part which holds the glass with the inserting disk from inside and remove it.

Ex.

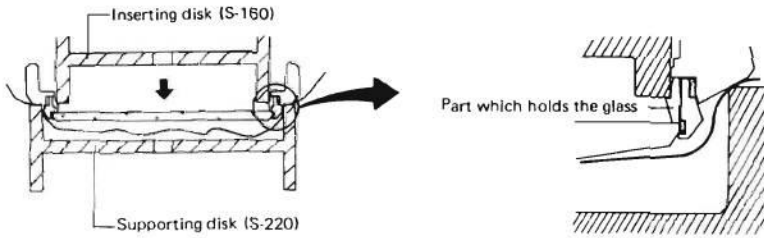

Note: Be sure to replace the used plastic gasket with a new one in order to maintain water resistance.

2. Disassembling direction of module

- Remove the module from the dial side.

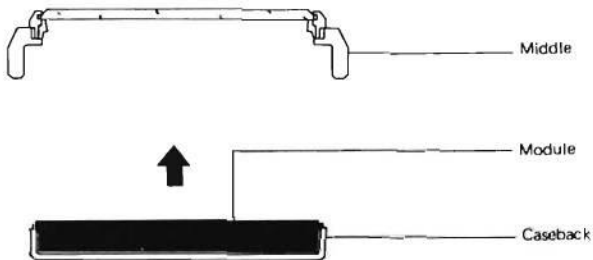

C0 type

1. Construction and remarks for repair

- How to remove the glass
First disassemble the glass unit, and then remove the glass.

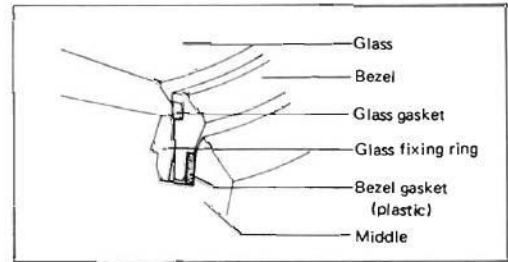

Push the glass fixing ring.

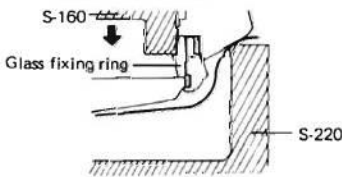

Push the glass from above.

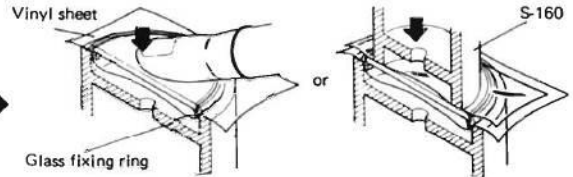

2. Disassembling and reassembling (typical example)

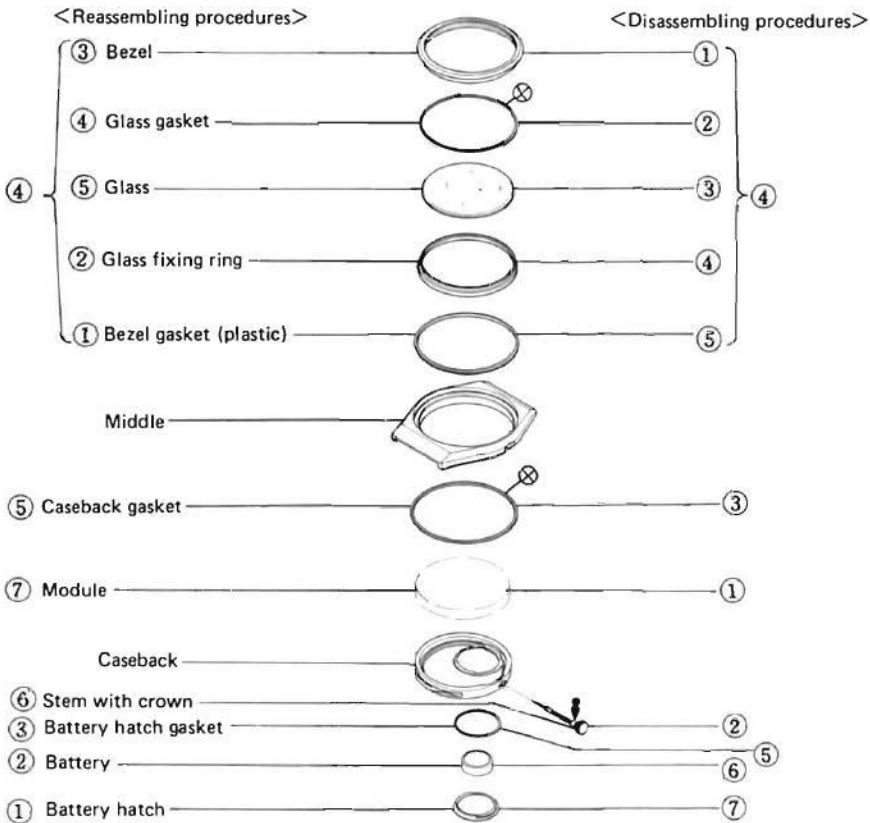

2-1. Disassembling and reassembling of the glass unit

<Disassembling procedures>

1) Glass unit

- Push the glass fixing ring from inside.

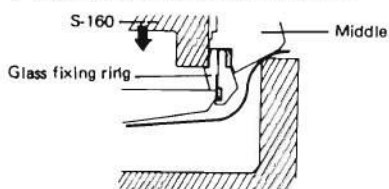

2) Bezel gasket (plastic)

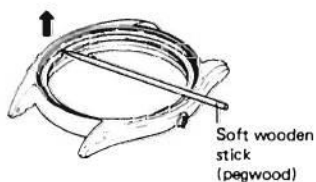

3) Glass (Glass fixing ring)

- Push the glass from outside.

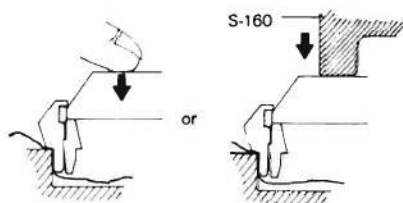

4) Glass gasket

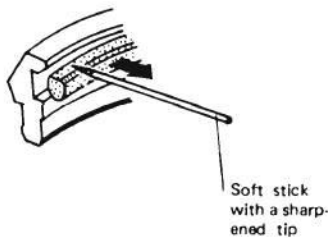

Note: Be sure to replace the gasket for glass with a new one.

<Reassembling procedures>

1) Glass gasket

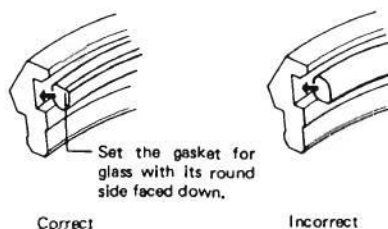

2) Glass (Glass fixing ring)

- Be sure to push the glass fixing ring with the inserting disk.

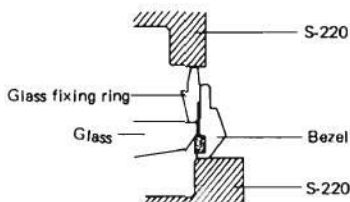

3) Bezel gasket (plastic)

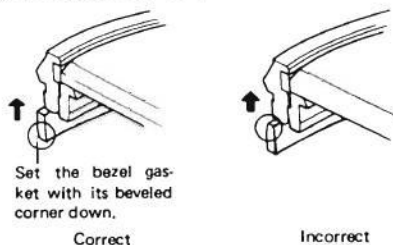

Note: Be sure to replace the plastic gasket for glass with a new one.

4) Glass unit

- Set the glass unit by pushing the upper surface of the bezel. (See the illustration below.)

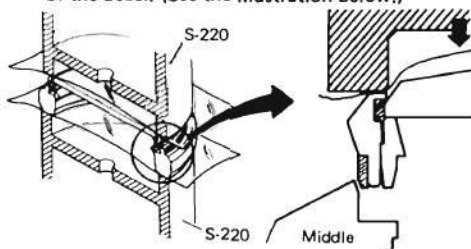

K TYPE OF CASE CONSTRUCTION

K type of case construction

1. How to remove the glass

- Push the glass from above with your finger and remove it.

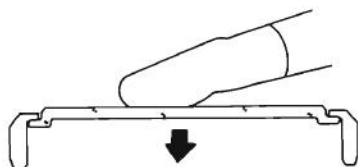

2. Disassembling direction of module

- Remove the module from the dial side.

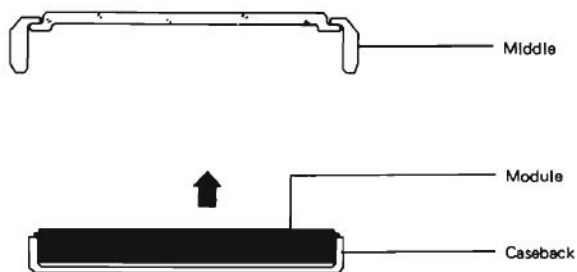

M TYPE OF CASE CONSTRUCTION

M type of case construction

1. How to remove the glass

- Remove the glass by prying up the glass fixing ring (inside of the middle) with a screwdriver.

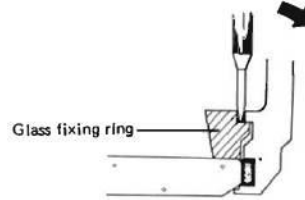
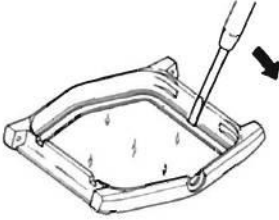

Note: Be careful not to deform the glass fixing ring.

2. Disassembling direction of module

- Remove the module from the dial side.

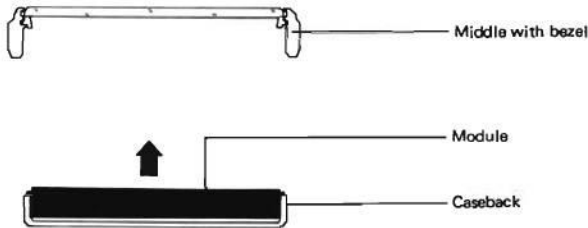

M0 type

1. Construction and remarks for repair

- How to remove the glass
Remove the glass by prying up the glass fixing ring (inside of the middle) with a screwdriver.

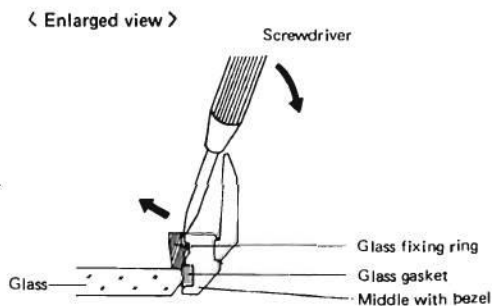
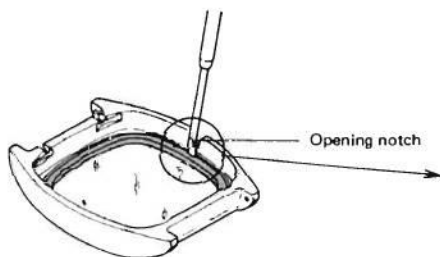
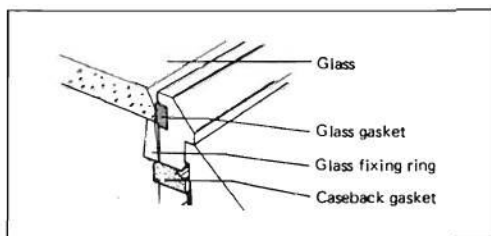

2. Disassembling and reassembling (typical example)

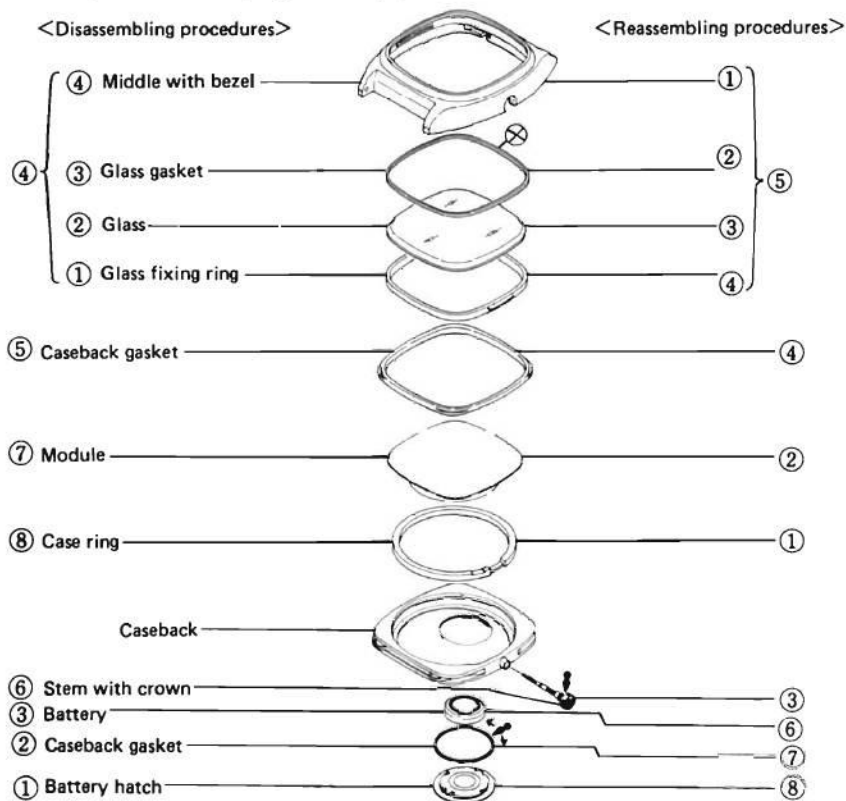

2-1. Disassembling and reassembling of glass

<Disassembling procedures>

1) Middle with bezel

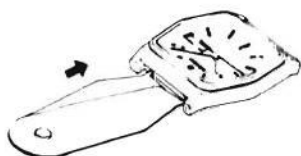

2) Glass fixing ring

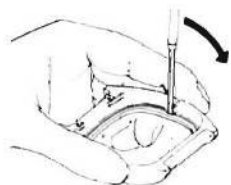

Put the tip of a screwdriver into the opening notch, and pry up.

Pry up while pushing up the glass with your fingers, and the glass will be removed.

3) Glass, and glass gasket

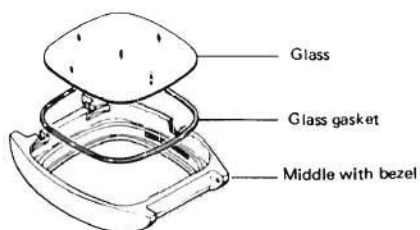

<Reassembling procedures>

1) Glass gasket

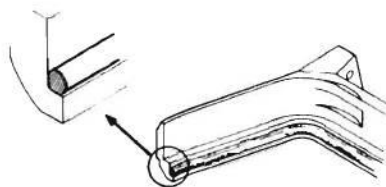

Be sure to set the glass gasket with its rounded side up.

2) Glass

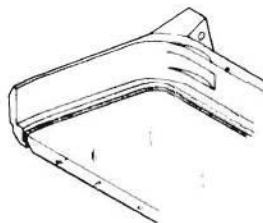

3) Glass fixing ring

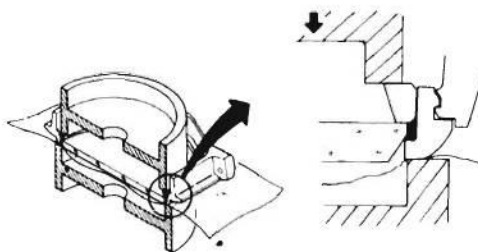

P TYPE OF CASE CONSTRUCTION

P, type of case construction

1. Disassembling and reassembling of glass

<Disassembling procedure>

Heat the adhered portion of the glass for about 10 minutes with a dryer and push it from inside with fingers to remove it.

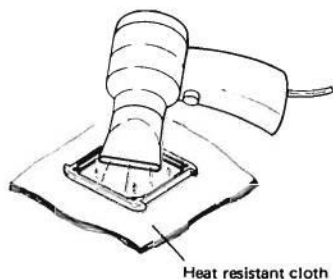

Keep the dryer about 1 cm above the case

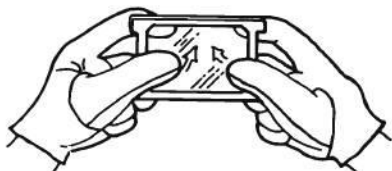

Wear cotton gloves

<Reassembling procedure>

Wipe off any contamination on the surface of the parts to be adhered, and then apply SEIKO glass adhesive (S-310).

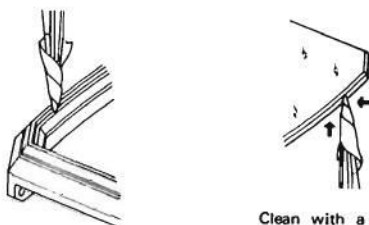

Clean with a cloth moistened with alcohol.

- Remarks on adhering
- Adhering time
 - At normal temperature (24°C): approx. 24 hrs. (75°F)
 - At 40°C to 50°C: approx. 5 to 6 hrs. (105°F to 120°F)
- An unequal mixing ratio of the base and the hardner weakens adhesion.

Notes: ● In case the glass is broken into pieces, remove the broken glass with a screwdriver heating with hot air. Be careful not to injure your fingers.

● The case will be hot. Be careful not to burn your fingers.

● Do not heat the plastic glass.



2. Disassembling direction of module

Remove the movement from the dial side.

