

CITIZEN®



Eco-Drive®





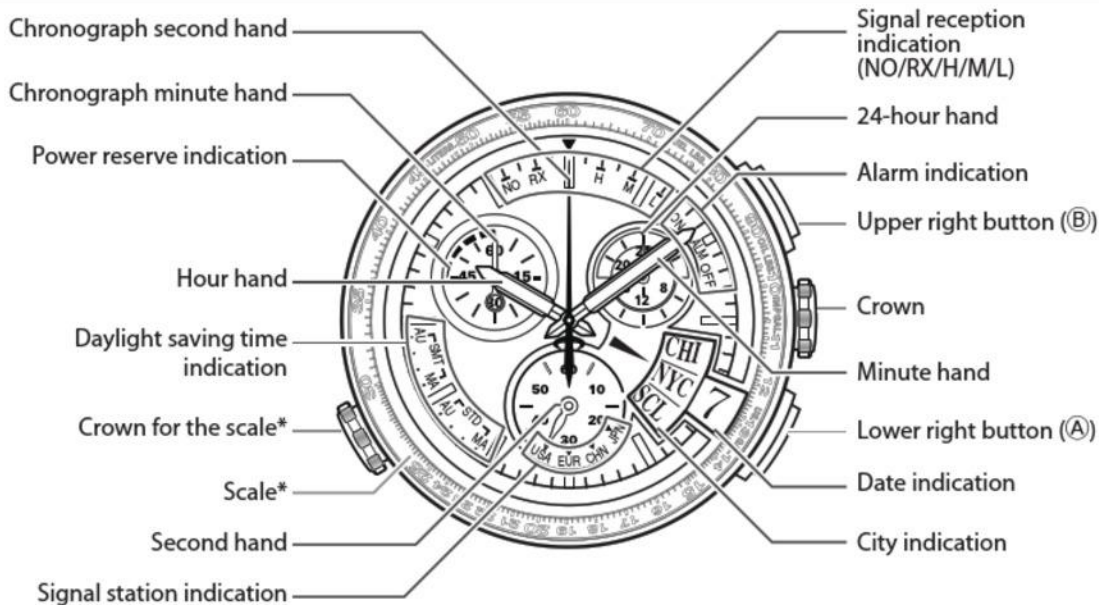

Parts identification



- The illustrations in this instruction manual may differ from the actual appearance of your watch.

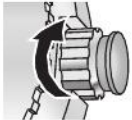

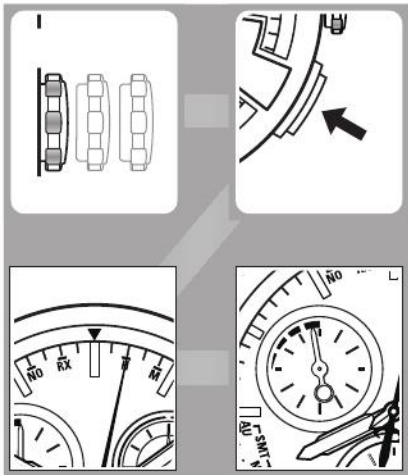

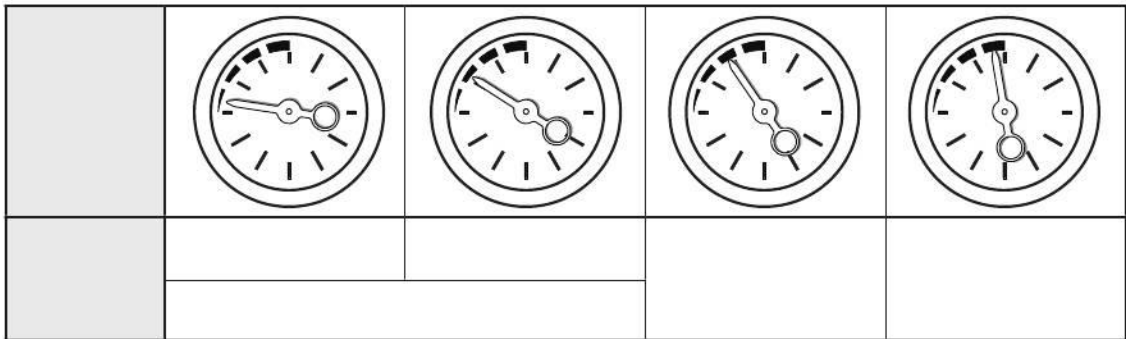
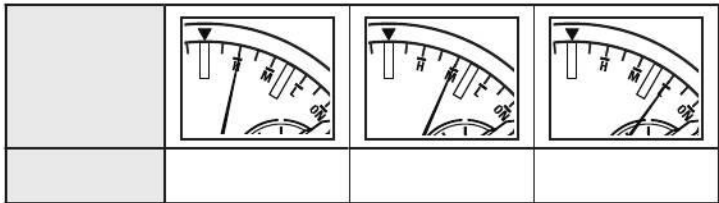

2: Checking the reference position of the hands

If the reference position is incorrect, the time and calendar are not indicated properly.

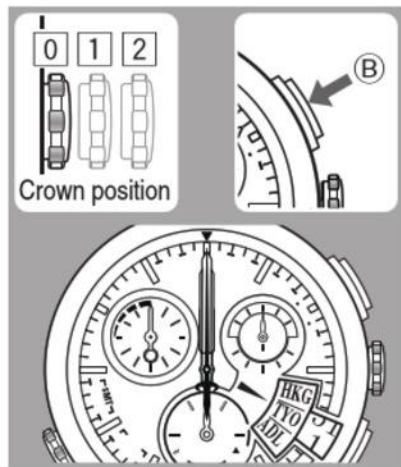

Correct reference position

1. Ensure that the crown is in position 0.
2. Press and hold the upper right button (B) for ten seconds.

The hands move quickly to show the current reference position.

The correct reference position is when;

- all hands are indicating 12:00;
 - the date indication is between “31” and “1”.
- You can select any city for checking the reference position.

If all the hands are not in the correct reference position, adjust them referring to page 30.

3. Press the upper right button (B) to complete confirmation.

- Before the operation above, reset the chronograph.

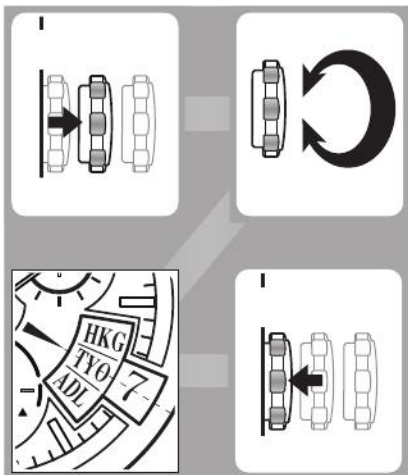



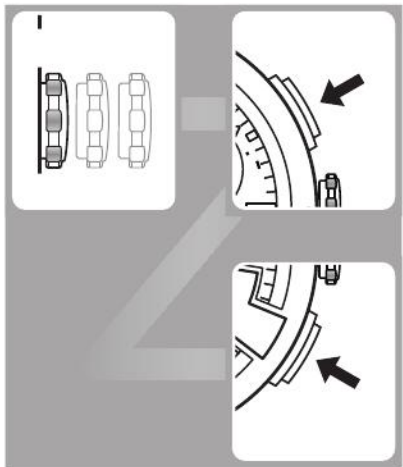

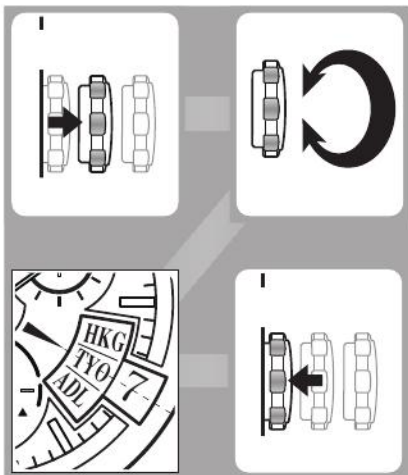

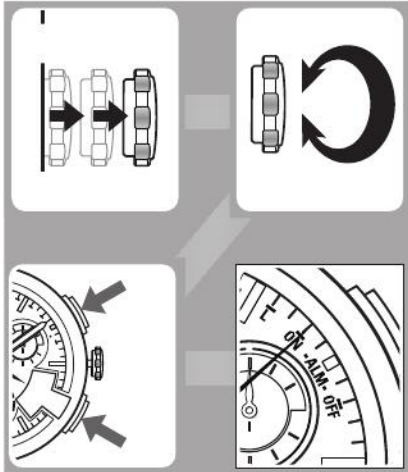

1

2

3

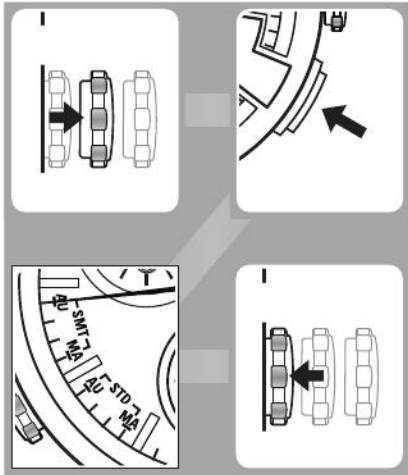

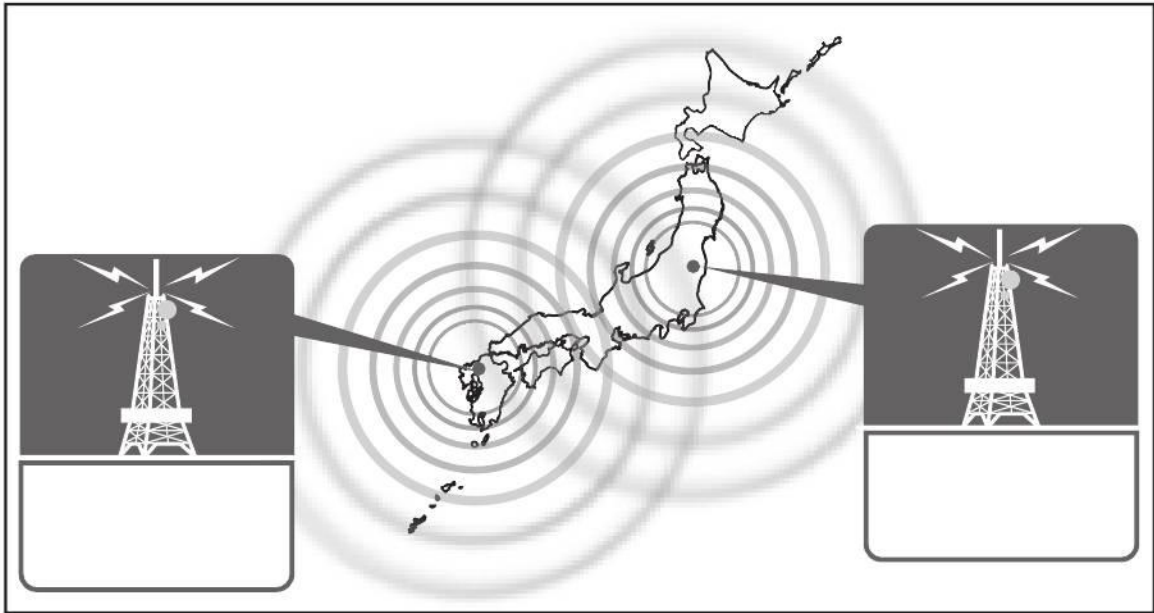

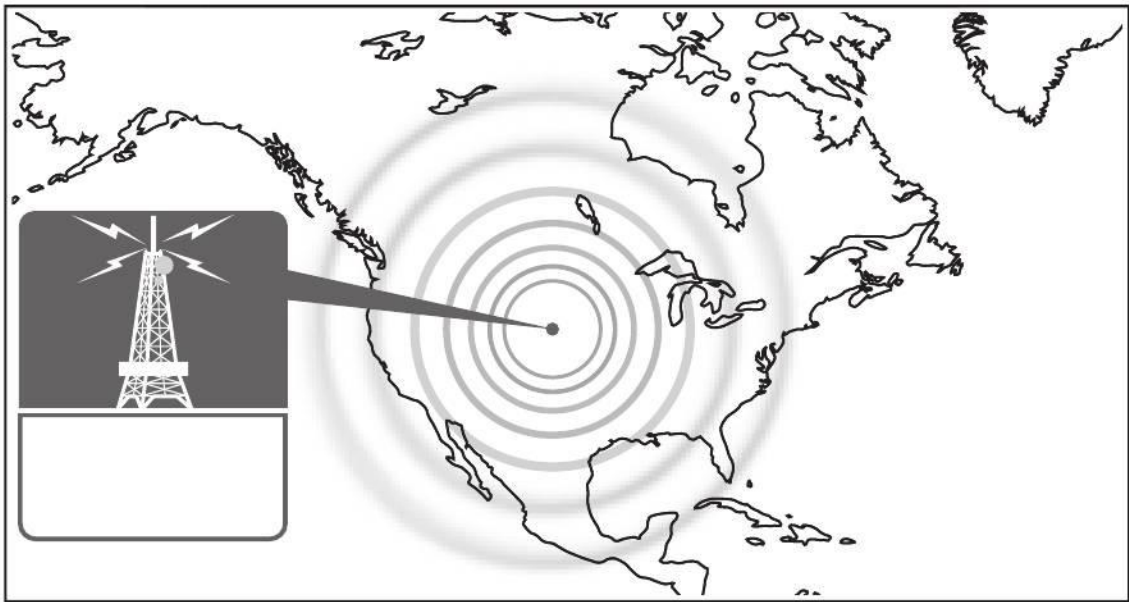

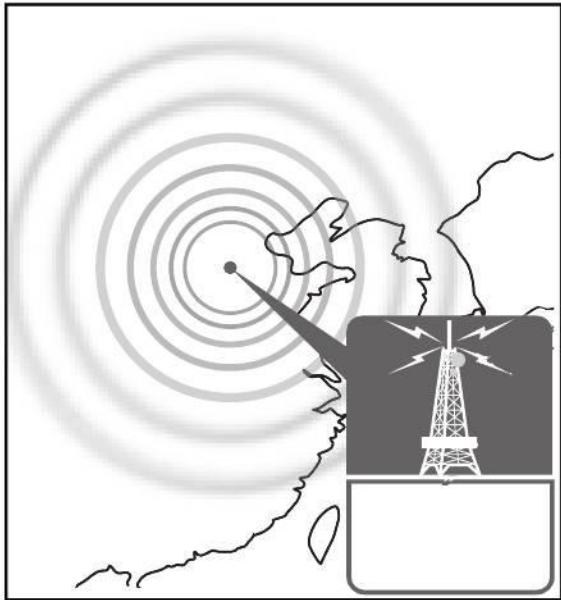
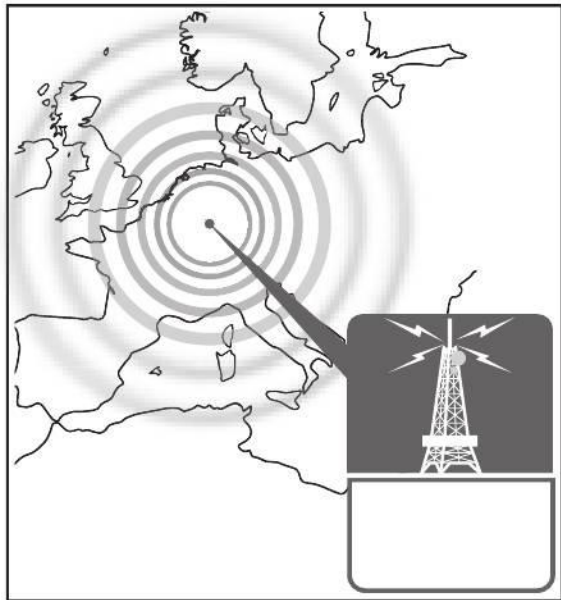

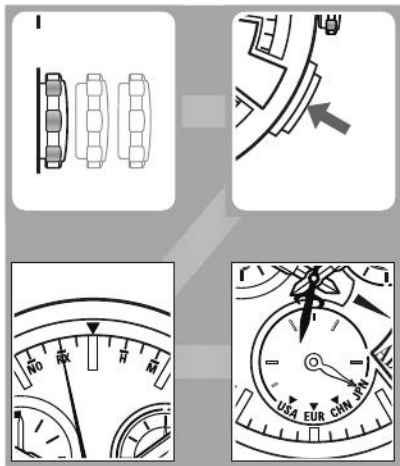





				



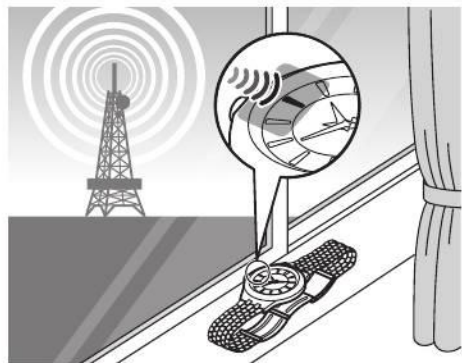

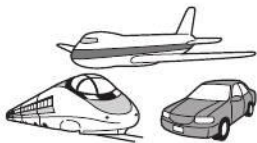

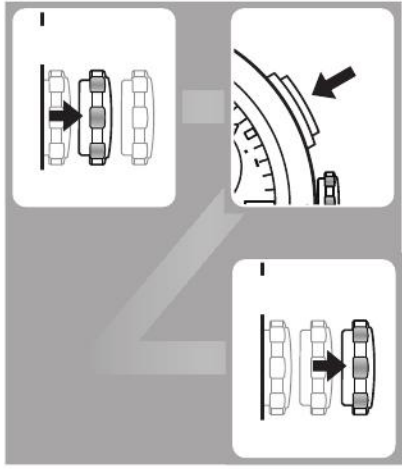

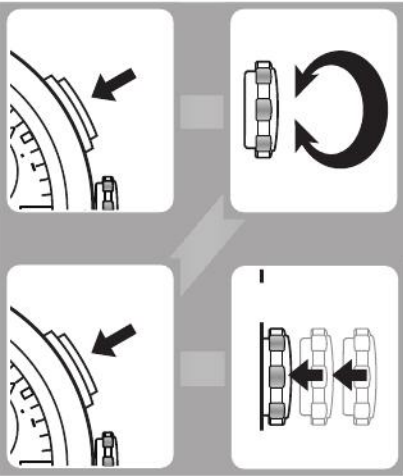

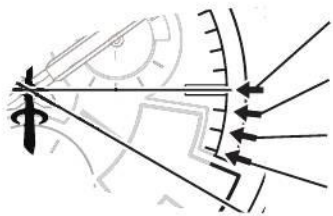
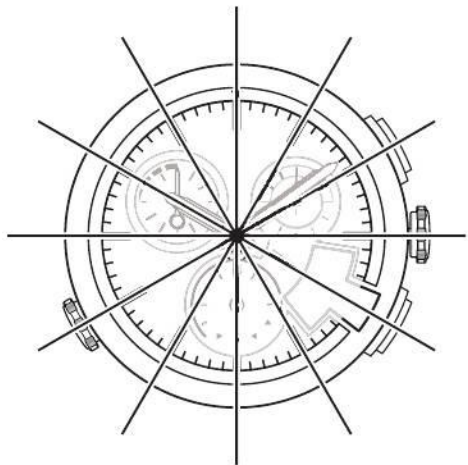



■

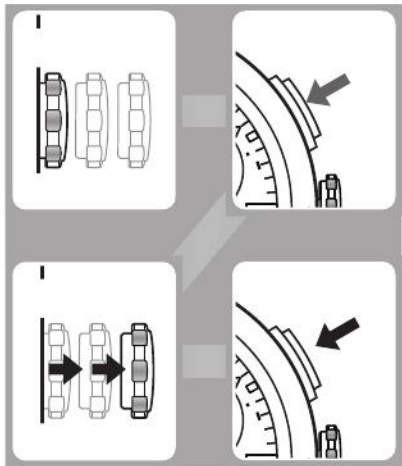

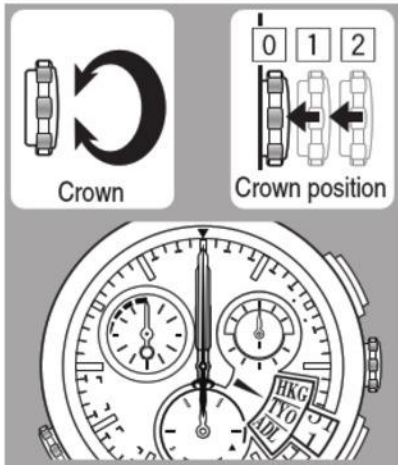

The correct reference position is when;

- all hands are indicating 12:00;
- the date indication is between “31” and “1”.

- Each time you press the upper right button (Ⓑ), the item selection changes in the following order (the selected item moves a little to indicate the selection):
Chronograph minute hand/Date → Hour/24-hour hand → Minute/Second hand → Chronograph second hand → To the beginning

5. Rotate the crown to adjust the selected item.

- The item starts to move continuously by rotating the crown quickly. To stop the rapid movement, rotate the crown.
- When adjusting the date and chronograph minute hand, rotate the crown clockwise (right).

6. Repeat steps 4 and 5 to adjust the other items.

7. Push the crown in to position 0.

8. Press the upper right button (Ⓑ).

You have now completed adjusting the reference position.



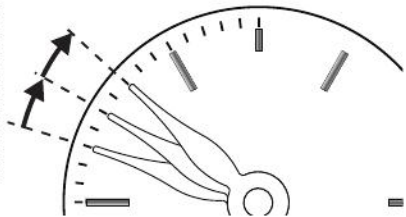

1

2

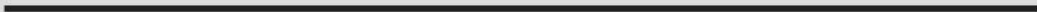



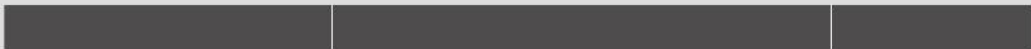

--	--	--



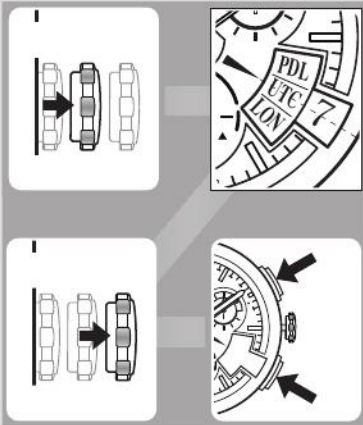



I

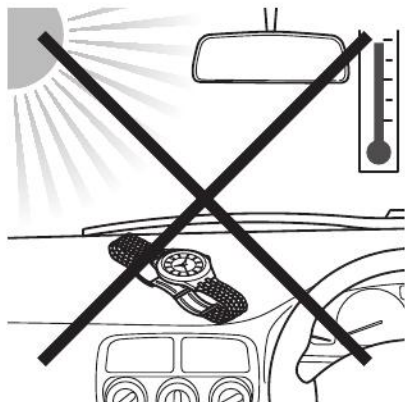



					







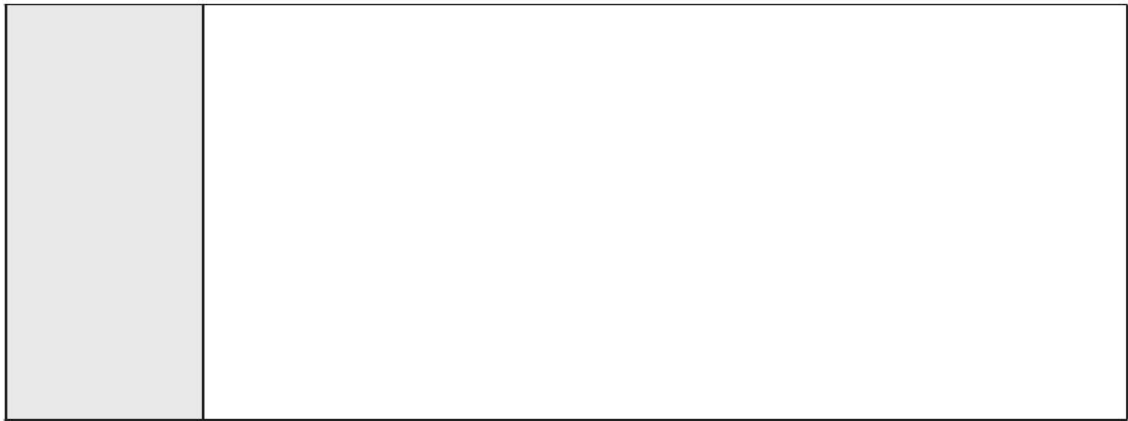

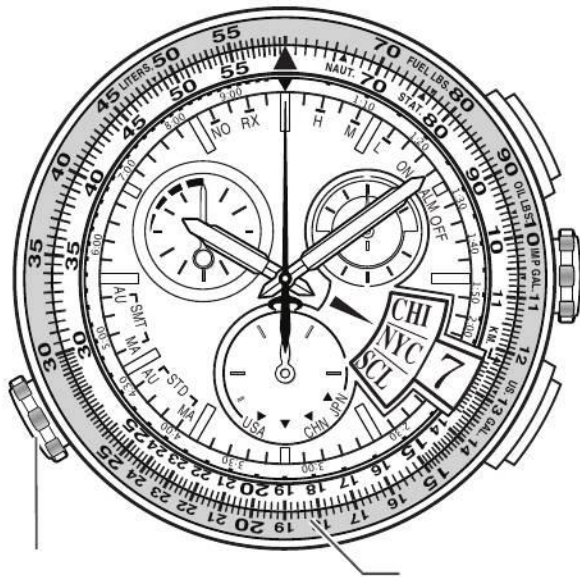

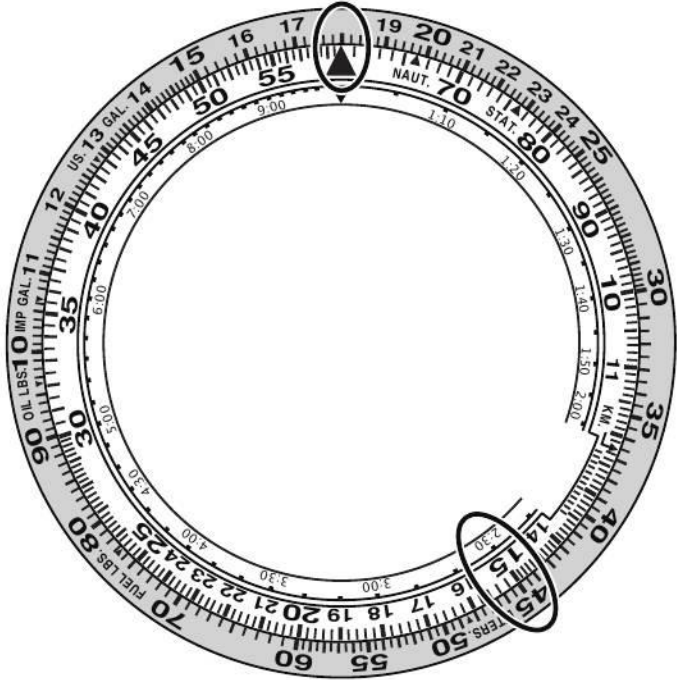



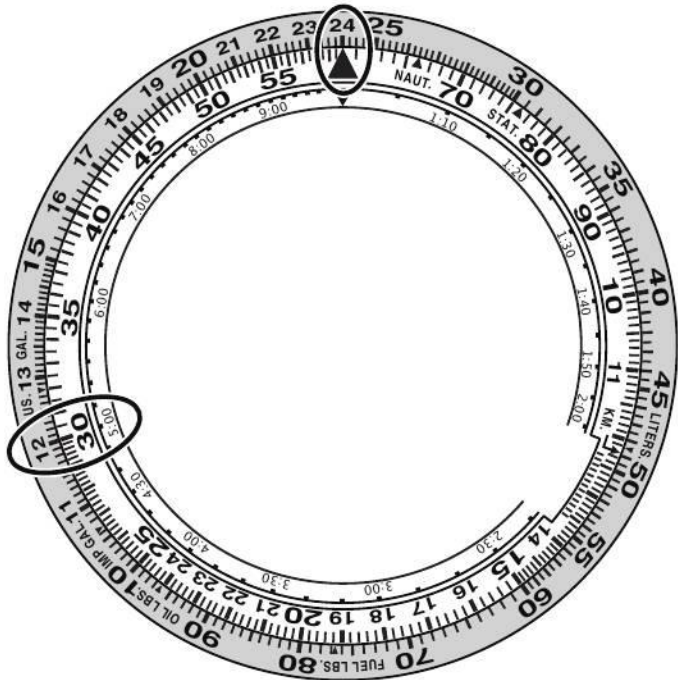





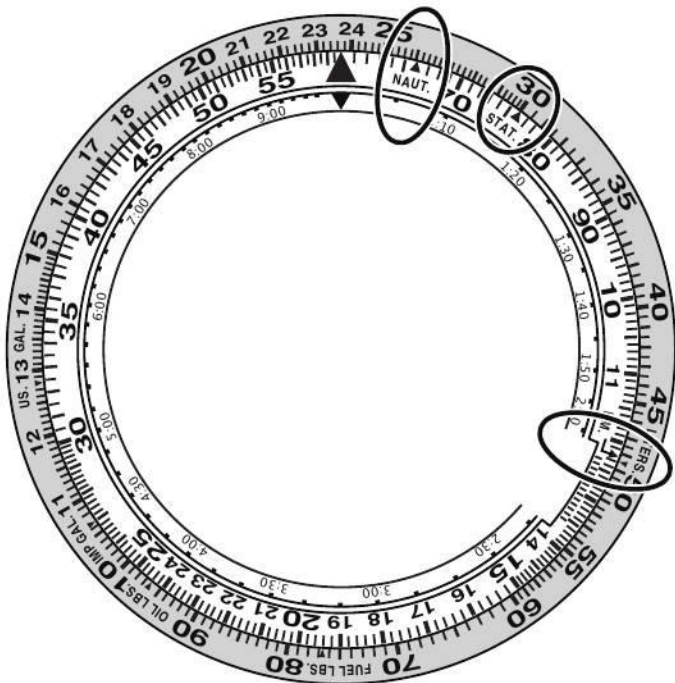

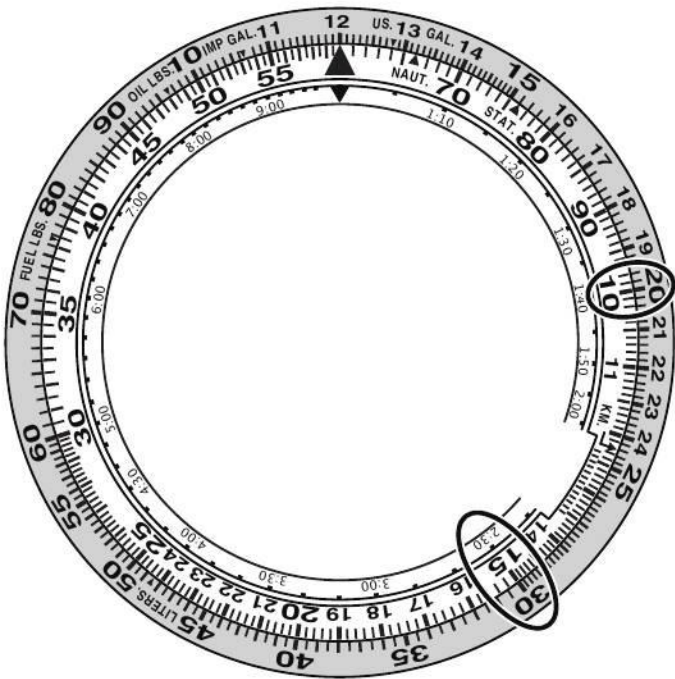

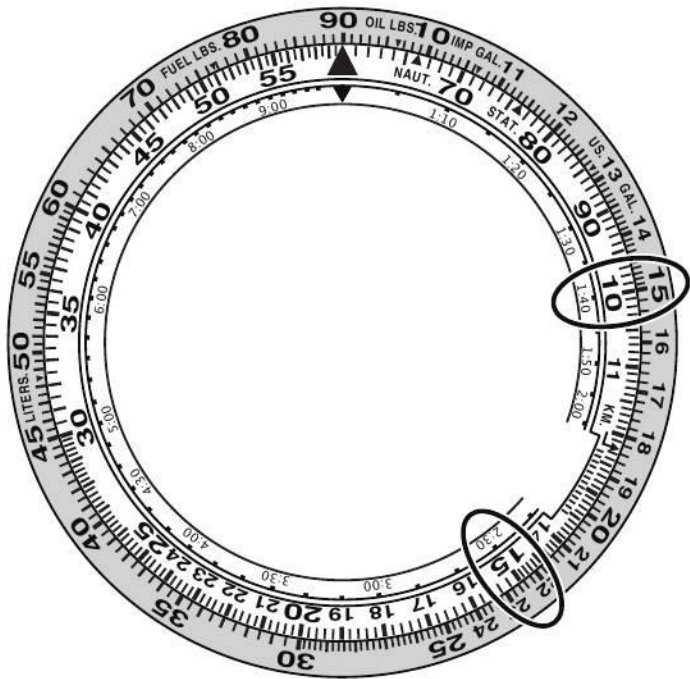

CE

