

**PowerLite® Home Cinema 8345
Home Theater Projector**

User's Guide

Copyright Notice

All rights reserved. No part of this publication may be reproduced, stored in a retrieval system, or transmitted in any form or by any means, electronic, mechanical, photocopying, recording, or otherwise, without the prior written permission of Seiko Epson Corporation. The information contained herein is designed only for use with this Epson product. Epson is not responsible for any use of this information as applied to other products.

Neither Seiko Epson Corporation nor its affiliates shall be liable to the purchaser of this product or third parties for damages, losses, costs, or expenses incurred by purchaser or third parties as a result of: accident, misuse, or abuse of this product or unauthorized modifications, repairs, or alterations to this product, or (excluding the U.S.) failure to strictly comply with Seiko Epson Corporation's operating and maintenance instructions.

Seiko Epson Corporation shall not be liable for any damages or problems arising from the use of any options or any consumable products other than those designated as Original Epson Products or Epson Approved Products by Seiko Epson Corporation.

Trademarks

Epson is a registered trademark, 1080Perfect and C'Fine are trademarks, and Epson Exceed Your Vision is a registered logomark of Seiko Epson Corporation.

PowerLite and PrivateLine are registered trademarks, DigiScan and AccuCinema are trademarks, and Extra Care and Epson Connection are service marks of Epson America, Inc.

HDMI, the HDMI logo, and High-Definition Multimedia Interface are registered trademarks of HDMI Licensing, LLC.



Pixelworks, DNX, and the DNX logo are trademarks of Pixelworks, Inc.

x.v.Color is a trademark of Sony Corporation.

x.v.Color

General Notice: Other product names used herein are for identification purposes only and may be trademarks of their respective owners. Epson disclaims any and all rights in those marks.

This information is subject to change without notice.

Contents

Introduction	6
Projector Parts	7
Remote Control	9
Optional Accessories	10
Registration and Warranty	10
Using This Manual	11
Setting Up the Projector	12
Choosing a Location	12
Installing the Projector	16
Connecting the Cables	18
Connecting Video and Computer Equipment	18
Making Other Connections	20
Installing Batteries in the Remote Control	21
Turning the Projector On and Off	21
Turning On the Projector	21
Turning Off the Projector	22
Selecting the Image Source	23
Positioning the Image	24
Making Basic Adjustments	26
Focusing and Zooming	26
Choosing the Aspect Ratio	27
Choosing the Color Mode	28
Advanced Color Adjustments	29
Adjusting the Gamma Setting	30
Adjusting RGBCMY	31
Locking the Projector	32

Making Detailed Adjustments	33
Using the Menu System	33
Changing How the Menus Display	35
Adjusting the Picture Quality	35
Input Brightness Settings	35
Sharpness and Picture Quality Settings	37
Color Settings	39
Adjustments for Computer Images	41
Selecting Memory Settings and Resetting the Projector	42
Selecting Memory Settings	42
Creating Memory Settings	42
Deleting Saved Memory Settings	43
Resetting the Projector	43
Customizing Projector Features	44
Image Sizing	44
Screen Options	45
Other Setup Options	45
Maintenance	48
Cleaning the Lens	48
Cleaning the Projector Case	49
Cleaning and Replacing the Air Filter	49
Replacing the Lamp	51
Resetting the Lamp Usage Timer	54
Checking the Projector Status	54
Storing the Projector	55
Transporting the Projector	55
Problem Solving	56
What To Do When the Lights Come On or Flash	56
Solving Picture Problems	58
Solving Remote Control Problems	61
Where to Get Help	62

Specifications	63
General	63
Lamp	63
Remote Control	63
Dimensions	64
Electrical	64
Environmental	64
Safety	64
Compatible Video Formats	65
ESC/VP21 Command Codes	67
Notices	68
Important Safety Information	68
FCC Compliance Statement	70
Declaration of Conformity	71
Epson America, Inc. Limited Warranty	71
Index	73

Introduction

The PowerLite® Home Cinema 8345 projector lets you enjoy theater-quality images in the relaxing environment of your own home. Designed especially for home cinema use, it offers these outstanding features:

- Native 1080p (1920 × 1080) resolution, dynamic contrast ratio up to 25000:1, and up to 1800 lumens of brightness (white light output and color light output) for incredibly rich, sharp images in any room lighting
- Auto Iris system that constantly controls the light output based on the gamma and black/white levels of your projected content, for perfectly adjusted images and deepest blacks
- Epson C²Fine™ 3LCD technology for reliable picture quality, increased contrast ratio and uniform colors
- 1080Perfect™ video processing for more film-like images free of noise or artifacts
- 10-bit color quality (digital only) for unmatched color accuracy, with over a billion colors available
- Epson AccuCinema™ color management delivered by the built-in optical Cinema Filter blocks out excess light for an expanded, purer color range and sophisticated grayscale tracking
- HDMI® (High-Definition Multimedia Interface®) port for superior, uncompressed digital video
- True 16:9 wide-format projection
- Flexible setup configurations, including front projection and ceiling mounted, with vertical and horizontal offset lens shift
- Five color modes, including x.v.Color™, to quickly optimize viewing for different lighting environments, and a vast array of custom color adjustments

Projector Parts

Front

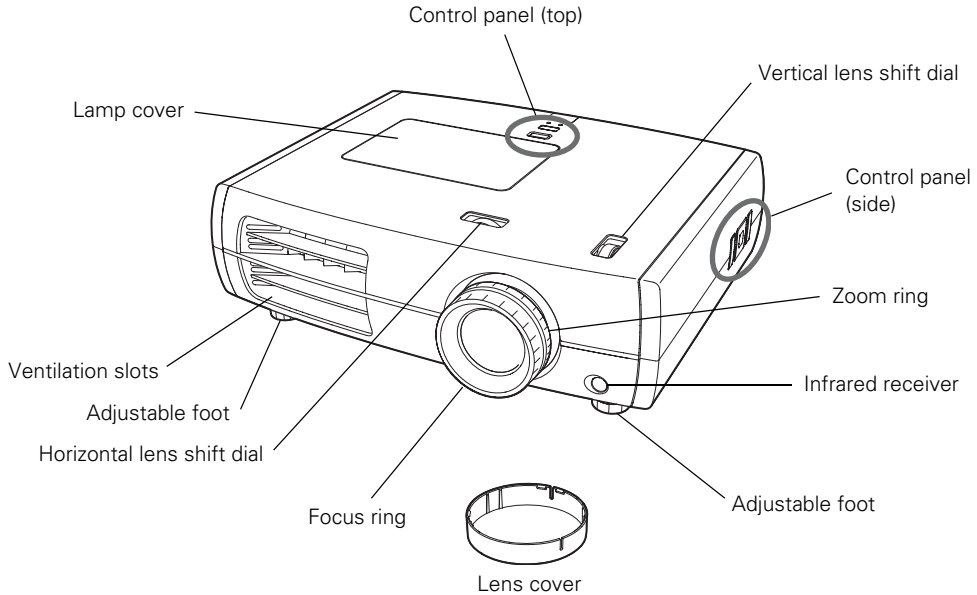

Back

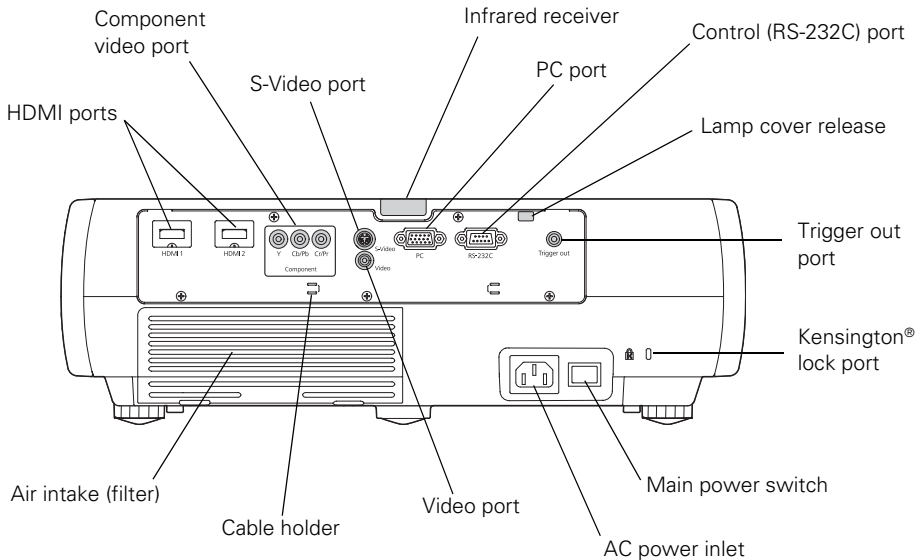

Bottom

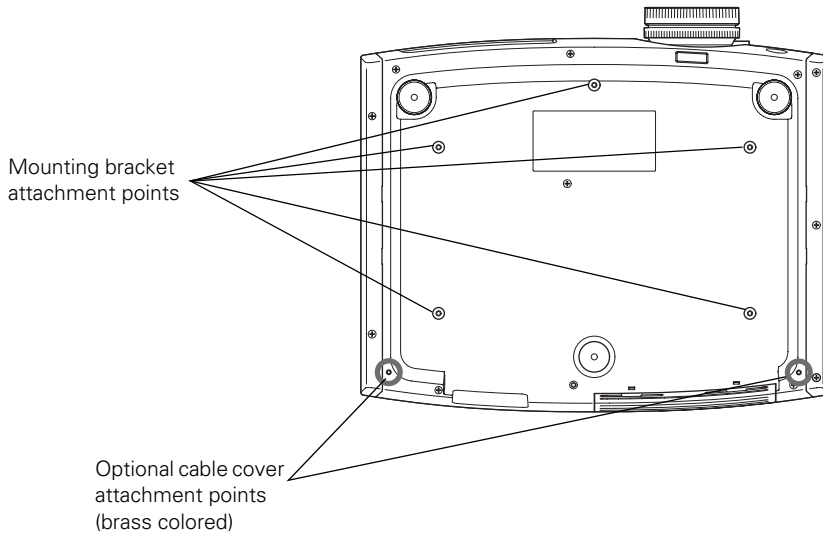

Projector Control Panel

Top control panel

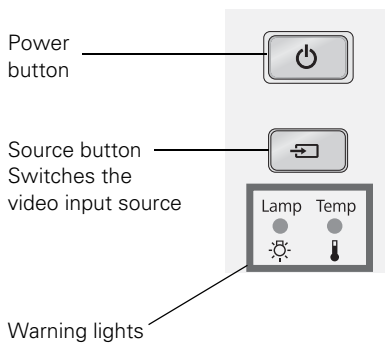

Side control panel

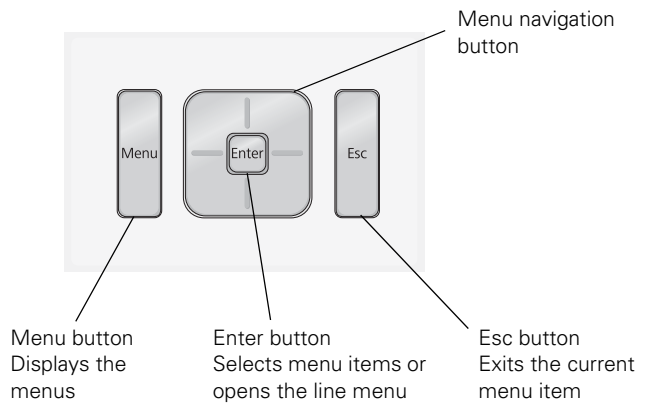

Remote Control

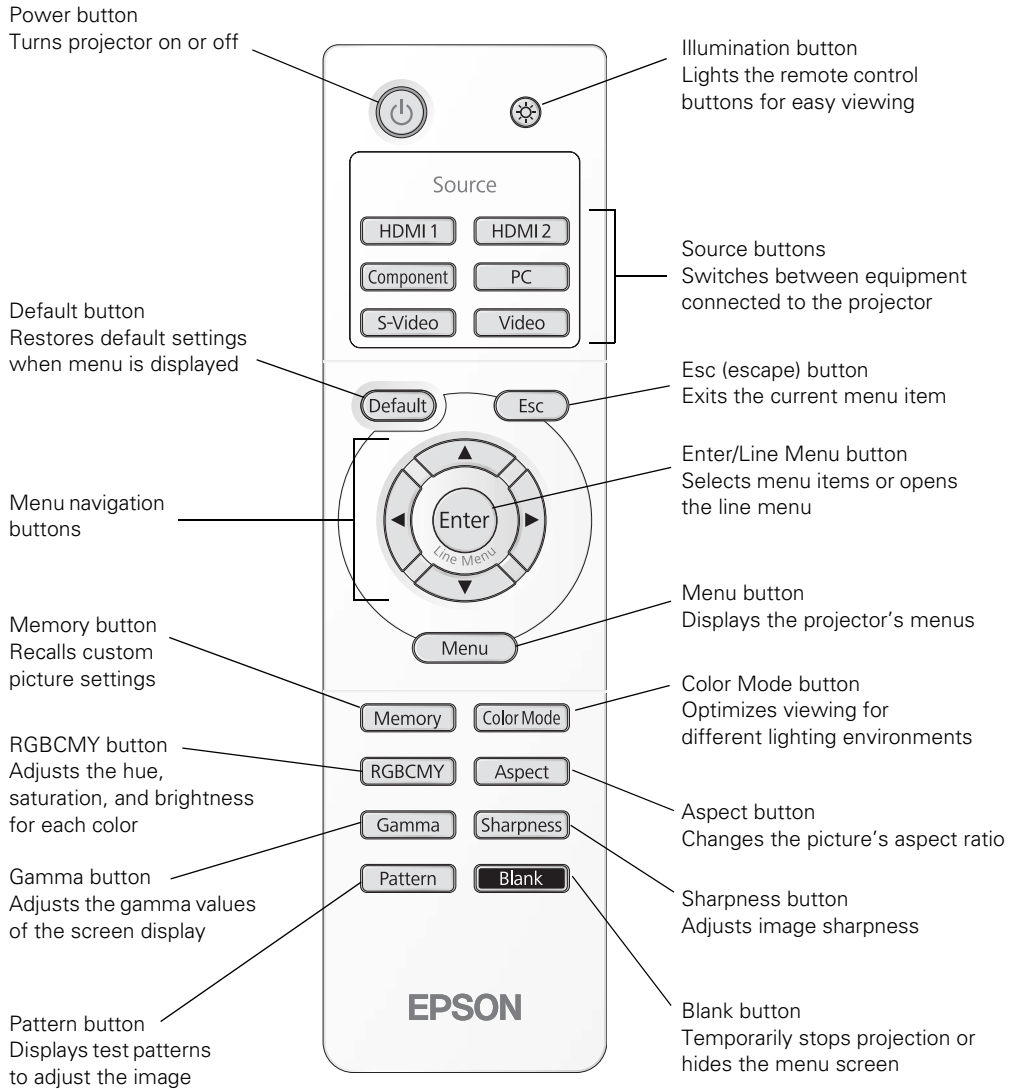

Optional Accessories

Epson provides the following optional accessories for the projector:

Product	Part number
Replacement lamp	V13H010L49
Air filter replacement	V13H134A21
Kensington security lock (anti-theft device)	ELPSL01
Cable cover	V12H003002
Projector mount	ELPHB550

In addition to the accessories listed above, 1-year and 2-year extended service plans are available. You can purchase these plans and other accessories from an authorized Epson reseller. To find the nearest reseller, please call 800-GO-EPSON (800-463-7766). To purchase online, visit www.epsonstore.com (U.S. sales) or www.epson.ca (Canadian sales).

Registration and Warranty

Your projector comes with a basic two-year carry-in warranty. For details, see page 71.

In addition, Epson offers free Extra CareSM Home Service. In the unlikely event of an equipment failure, you won't have to wait for your unit to be repaired. Instead, Epson will ship you a replacement unit anywhere in the United States or Canada. See your *Extra Care Home Service* brochure for details.

To register, simply follow the registration instructions on the CD, or register online at epson.com/webreg. Registering also lets you receive special updates on new accessories, products, and service.

Using This Manual

This book contains all the information you need to use the projector, in addition to basic setup and maintenance instructions, troubleshooting tips, important safety instructions, specifications, and warranty information.

Please follow these guidelines as you read through the manual:

WARNING: Must be followed carefully to avoid bodily injury.

Caution: Must be observed to avoid damage to your equipment.

Note: Contains important information about your projector.

Tip: Contains helpful projection tips.

Need additional help? Take advantage of Epson's automated support services 24 hours a day at epson.com/support (U.S.) or epson.ca/support (Canada). Use this site to view FAQs (Frequently Asked Questions) or product information and e-mail your questions to Epson support.

If you need more help, you can use the Epson PrivateLine® Support service. Call (800) 637-7661 and enter the PIN on the PrivateLine support card that came with your projector.

Setting Up the Projector

Follow the instructions in this section to choose a location for the projector, connect the cables, and display an image.

Choosing a Location

You can install the projector for the viewing setups shown below, as well as rear projection.

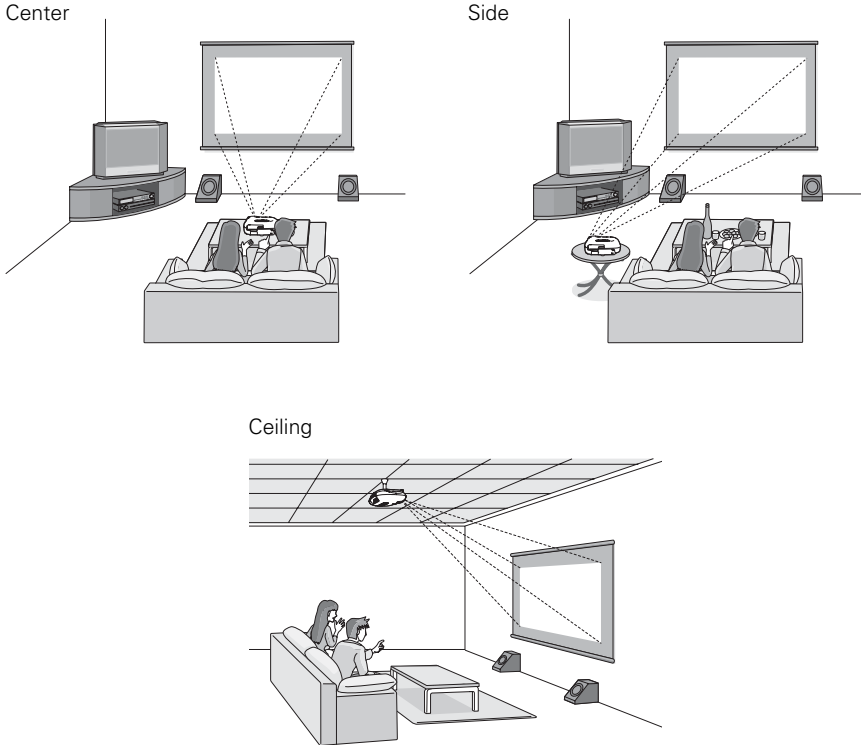

Ideally, keep the projector level and place it at a height so its lens is centered between the top and bottom of the screen, as shown below. If this is not possible, use the lens shift dials to reposition the image. As a rule of thumb, you can use lens shift to move the image up or down by nearly its full height, and left or right by about one-half its width (for details, see page 25).

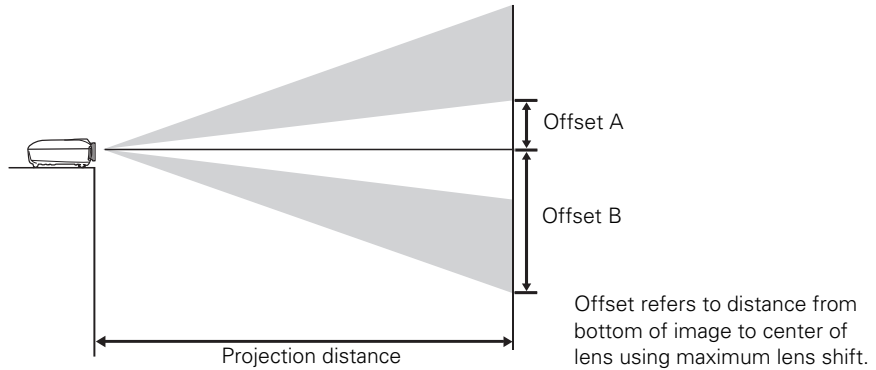

If you place the projector off to the side, aim it straight ahead (rather than at the center of the screen), then use the horizontal lens shift dial to center the image on the screen.

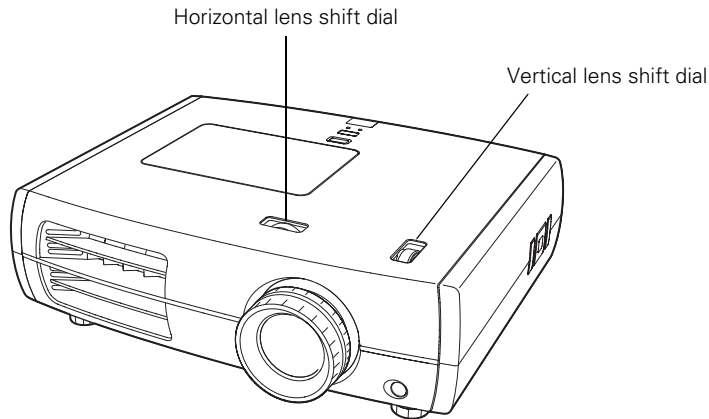

Caution: Do not try to move the lens by hand, or you may damage the projector. Always use the lens shift dials to change the lens position.

The size of the image is determined by the distance from the projector's lens to the screen. Depending on your display settings and how you use the Zoom ring, the actual size may differ. Use these tables as a guide for projector placement:

16:9 aspect ratio

Projection distance	Diagonal image size (width x height)	Offset A	Offset B	Horizontal Offset
2.8 to 6.2 feet 0.87 to 1.88 m	30 in. (26 x 15 in.) 76.2 cm (66 x 37 cm)	6.8 in. 17 cm	21.5 in. 55 cm	-11.5 to 11.5 in. -29 to 29 cm
3.8 to 8.3 feet 1.17 to 2.52 m	40 in. (35 x 20 in.) 101.6 cm (89 x 50 cm)	9.1 in. 23 cm	28.7 in. 73 cm	-15.4 to 15.4 in. -39 to 39 cm
5.8 to 12.5 feet 1.77 to 3.80 m	60 in. (51 x 28 in.) 152.4 cm (130 x 75 cm)	13.6 in. 35 cm	43.0 in. 109 cm	-23.1 to 23.1 in. -59 to 59 cm
7.8 to 16.7 feet 2.38 to 5.08 m	80 in. (71 x 39 in.) 203.2 cm (180 x 100 cm)	18.2 in. 46 cm	57.4 in. 146 cm	-30.8 to 30.8 in. -78 to 78 cm
9.8 to 20.9 feet 2.98 to 6.36 m	100 in. (87 x 47 in.) 254 cm (220 x 120 cm)	22.7 in. 58 cm	71.7 in. 182 cm	-38.5 to 38.5 in. -98 to 98 cm
11.8 to 25.1 feet 3.59 to 7.64 m	120 in. (106 x 59 in.) 305 cm (270 x 150 cm)	27.0 in. 69 cm	86.0 in. 219 cm	-46.1 to 46.1 in. -117 to 117 cm
14.7 to 31.4 feet 4.50 to 9.56 m	150 in. (130 x 75 in.) 381 cm (330 x 190 cm)	34.0 in. 86 cm	107.6 in. 273 cm	-57.7 to 57.7 in. -147 to 147 cm
19.7 to 41.9 feet 6.01 to 12.76 m	200 in. (173 x 98 in.) 508 cm (440 x 250 cm)	45.4 in. 115 cm	143.5 in. 364 cm	-76.9 to 76.9 in. -195 to 195 cm

4:3 aspect ratio

Projection distance	Diagonal image size (width x height)	Offset A	Offset B	Horizontal Offset
3.5 to 7.6 feet 1.07 to 2.31 m	30 in. (24 x 18 in.) 76.2 cm (61 x 46 cm)	8.3 in. 21 cm	26.3 in. 67 cm	-14.1 to 14.1 in. -36 to 36 cm
4.7 to 10.1 feet 1.44 to 3.09 m	40 in. (32 x 24 in.) 101.6 cm (81 x 61 cm)	11.1 in. 28 cm	35.1 in. 89 cm	-18.8 to 18.8 in. -48 to 48 cm
7.2 to 15.3 feet 2.18 to 4.66 m	60 in. (47 x 35 in.) 152.4 cm (120 x 90 cm)	16.7 in. 42 cm	52.7 in. 134 cm	-28.2 to 28.2 in. -72 to 72 cm
9.6 to 20.4 feet 2.92 to 6.23 m	80 in. (63 x 47 in.) 203.2 cm (160 x 120 cm)	22.2 in. 56 cm	70.2 in. 178 cm	-37.6 to 37.6 in. -96 to 96 cm
12 to 25.6 feet 3.66 to 7.79 m	100 in. (79 x 59 in.) 254 cm (200 x 150 cm)	27.8 in. 71 cm	87.8 in. 223 cm	-47.1 to 47.1 in. -120 to 120 cm

4:3 aspect ratio (continued)

Projection distance	Diagonal image size (width × height)	Offset A	Offset B	Horizontal Offset
14.4 to 30.7 feet 4.40 to 9.36 m	120 in. (94 × 71 in.) 305 cm (240 × 180 cm)	33.0 in. 85 cm	105.0 in. 268 cm	-56.5 to 56.5 in. -143 to 143 cm
18.1 to 38.4 feet 5.51 to 11.71 m	150 in. (118 × 91 in.) 381 cm (300 × 230 cm)	41.7 in. 106 cm	131.7 in. 334 cm	-70.6 to 70.6 in. -179 to 179 cm
24.1 to 51.2 feet 7.36 to 15.62 m	200 in. (161 × 118 in.) 508 cm (410 × 300 cm)	55.6 in. 141 cm	175.6 in. 446 cm	-94.1 to 94.1 in. -239 to 239 cm

To determine the exact image size when you know the projection distance (or the exact projection distance when you know the desired image size), you can use the Image Size Calculator. This program is available on the Epson website at epson.com/support (U.S.) or epson.ca/support (Canada).

Also keep these considerations in mind:

- Make sure there is plenty of space for ventilation around and under the projector. Do not set the projector on top of loose materials that could block the vents underneath.
- Make sure the projector is within 9.8 feet (3 m) of a grounded electrical outlet or extension cord.

Installing the Projector

To install the projector, you first need to determine the location, based on the size of your screen (maximum diagonal image size). Use the tables on page 14 as a guide to positioning the projector.

To suspend the projector from a ceiling, you will need the optional projector mount designed for the projector. See page 10 for ordering information. Follow the instructions included with the mount to install the projector.

WARNING: When installing or adjusting the ceiling mount, do not use adhesives to prevent the screws from loosening and do not use any type of oil or lubricant. These may cause the projector casing to crack and the projector may fall, causing serious injury and serious damage to the projector.

If you install the projector on the ceiling, you will need to invert the picture so that it appears right side up. Follow these steps:

1. Press the **Menu** button on the remote control.
2. Open the **Settings** menu, then select **Projection**.
3. Select **Front/Ceiling**.
4. Press the **Menu** button when done.

Note that you can rotate the Epson logo plate 180 degrees when suspending the projector from a ceiling.

If you are planning to use an AV controller with the projector, refer to the table of ESC/VP21 command codes on page 67. In addition, the projector's **Trigger out** port can be used to lower a projection screen (see page 46).

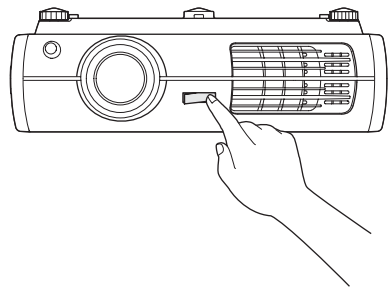

The following illustrations show the dimensions of the projector:

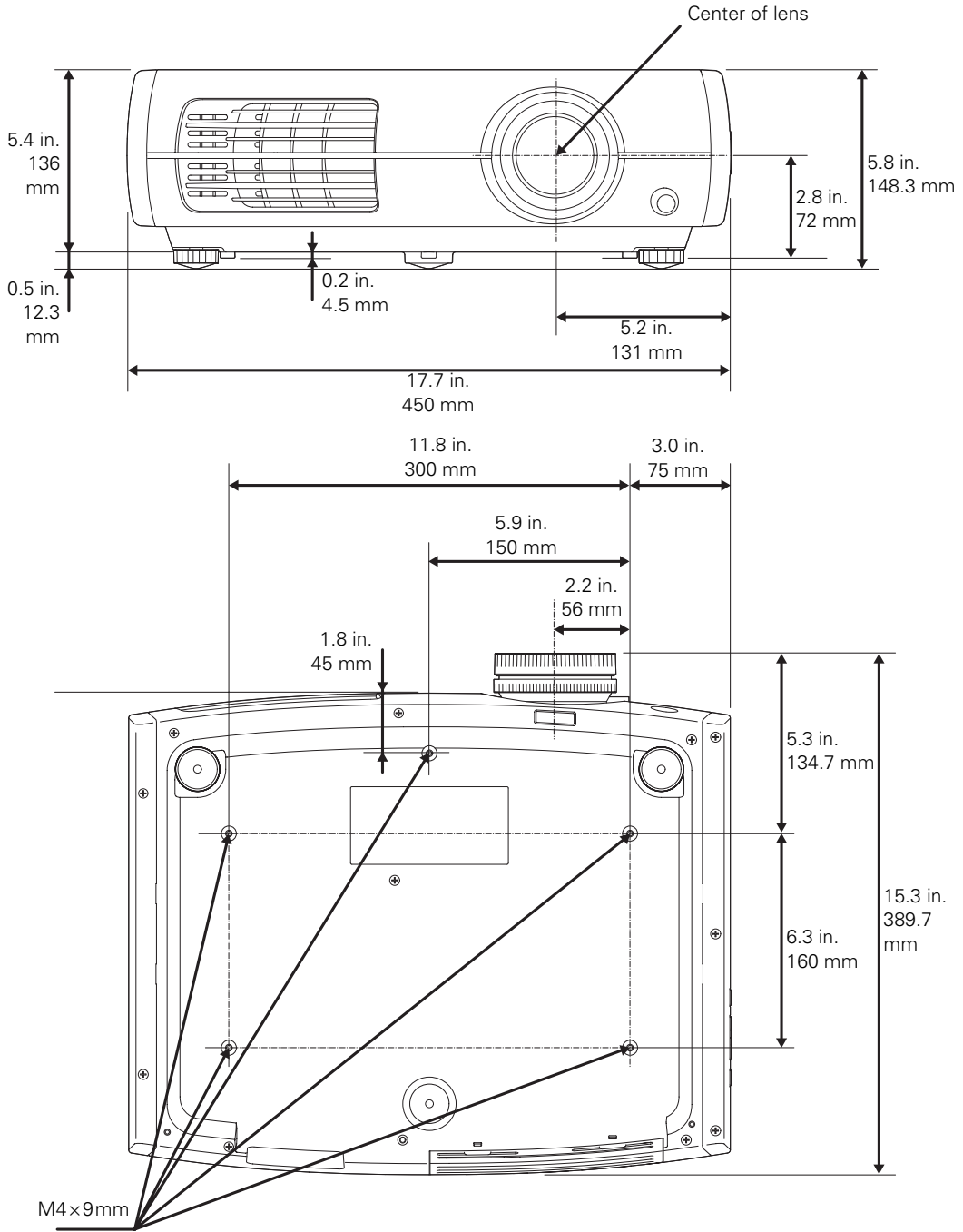









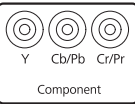

Connecting the Cables

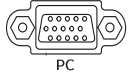
Connecting Video and Computer Equipment

You can connect the projector to many types of video equipment, such as a Blu-ray Disc™/DVD player, digital tuner, cable or satellite box, video game console, camcorder, or digital camera. You can also connect it to a desktop or laptop PC or Apple® Macintosh® system. For details on compatible video formats, see page 65.

You can connect up to six pieces of video equipment at the same time, using any of the commercially available cables shown below:

Port name	Video equipment connection	Computer connection
HDMI 1/ HDMI 2 	Use an HDMI cable: 	
Component 	Use a component video cable (with RCA-style connectors):  Connect the cable to the three component video ports. Match corresponding colors between the cable and the ports.	—
PC 	—	Use a Mini D-sub, 15-pin monitor cable to connect to a computer RGB (monitor) port: 
S-Video 	Use an S-video cable: 	—
Video 	Use an RCA video cable: 	—

For best results, connect your video equipment to the **HDMI** port, if possible. If your equipment doesn't support HDMI, connect it to one of the following ports (highest quality listed first): **Component** (for component video), **S-Video**, or **Video** (for composite video).

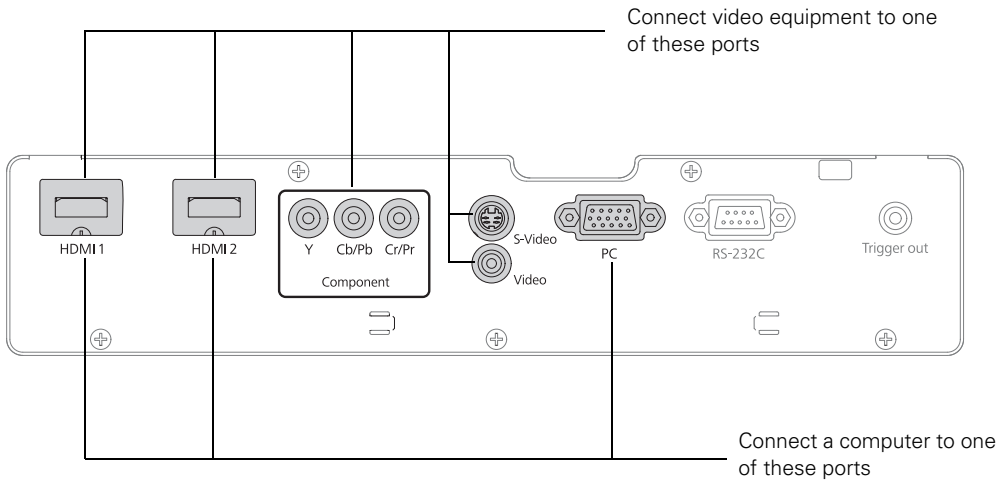

When you connect a large or heavy cable to the projector, such as an HDMI cable, it is recommended that you fasten it to one of the two cable holders using a commercially available cable tie.

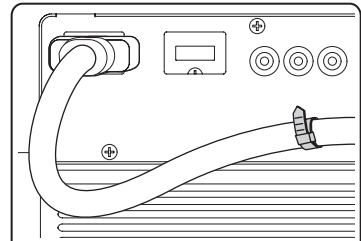

Making Other Connections

Connect the power cable and other cables described below, depending on how you plan to use the projector.

- Plug the power cable into the projector and a grounded electrical outlet.

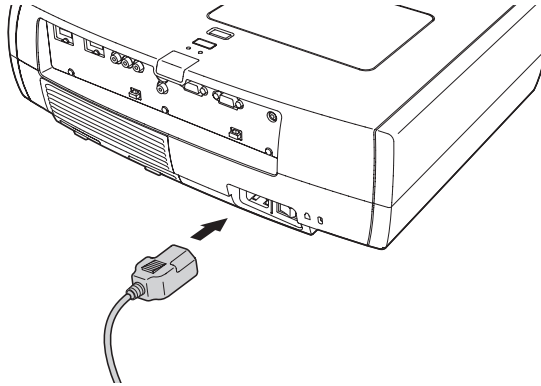

- The Trigger out port outputs a 12-volt DC signal when the projector is turned on. This lets a central control system monitor whether the projector is on or off, and can be used to raise or lower your projection screen automatically when the projector is in use.

Connect a 3.5-mm mini jack to the port, as shown. Use the Trigger Out setting to enable the port (see page 46).

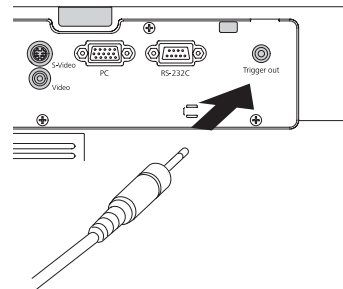

- To use an AV controller with the projector, connect a 9-pin null modem serial cable to the RS-232C port. Refer to the table of ESC/VP21 command codes on page 67.

Installing Batteries in the Remote Control

The remote control uses two AA batteries.

WARNING: Keep batteries away from children. If a battery is swallowed, contact your doctor immediately.

1. Release the tab and lift open the cover.
2. Insert two new AA batteries as shown.
3. Insert the tab on the cover and press it down until it clicks into place.

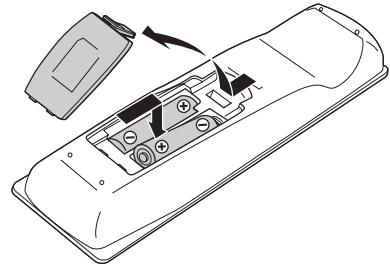

Aim the remote control at the screen, or at the front or back of the projector. Make sure you are within 30 feet of the projector.

If you suspect the batteries are weak, press the  illumination button. If the buttons do not glow, replace the batteries.

Turning the Projector On and Off

Turning On the Projector

1. Remove the lens cap.
2. Turn on any connected equipment you plan to use.

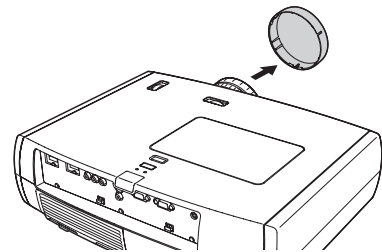

3. Turn on the main power switch on the back of the projector.

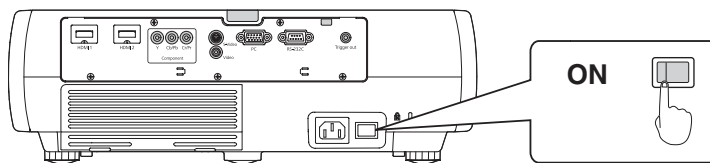

4. Press the  power button on the remote control or projector.

Remote control

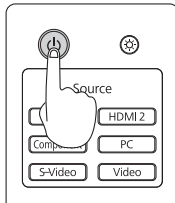

Projector

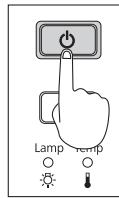



Note: To prevent children from turning on the projector, you can use the Child Lock feature. See page 32 for details.

If you'll be using the projector at an altitude above 4921 feet (1500 meters), turn on High Altitude Mode so the fan can properly cool the projector at the high altitude air pressure. See page 47 for details.

The projector takes about 30 seconds to warm up and display an image. If you don't see a picture, you may need to change the image source as described on page 23.

Turning Off the Projector

1. Turn off any equipment connected to the projector.
2. Press the  power button on the remote control or projector. When you see a confirmation message, press the  power button again to turn the projector off.

Caution: Turn off this product when not in use to prolong the life of the projector. Continuous 24-hour-a-day use may reduce the overall life of the product.

3. If you need to move the projector, wait for the  power light to stop flashing, then turn off the projector's main power switch on the back. You can now unplug the projector.



Caution: Never turn off the main power switch without first turning off the projector and letting it cool as described above, or you could damage it and reduce lamp life.

Selecting the Image Source

The source buttons on the projector and remote control let you switch between images from different pieces of equipment connected to the projector (such as a Blu-ray Disc/DVD player, cable or satellite box, or video game console).

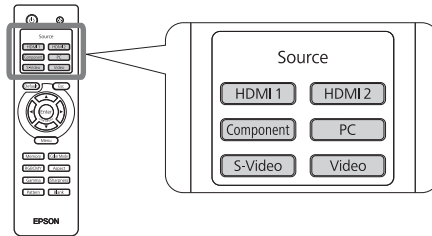
Press the **Source** button on the remote control that corresponds to the port to which your video source is connected.



If you press the  source button on the projector, you see a list of available sources. Press the  source button to move through the list and select the desired source.

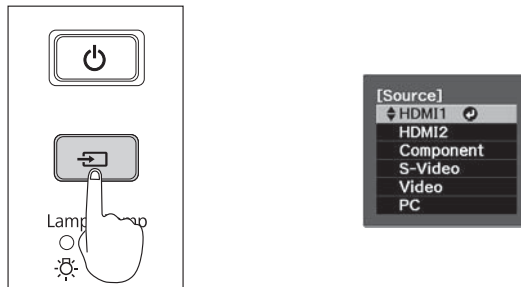

Note: If an image does not appear, see "Problem Solving" on page 56.

To temporarily turn off the image and darken the screen, press the **Blank** button on the remote control. Press the **Blank** button again to return to normal viewing.

Positioning the Image

If the image is not centered on the screen, use the horizontal and vertical lens shift dials to adjust its position.

Caution: Do not try to move the lens by hand, or you may damage the projector. Always use the lens shift dials to change the lens position.

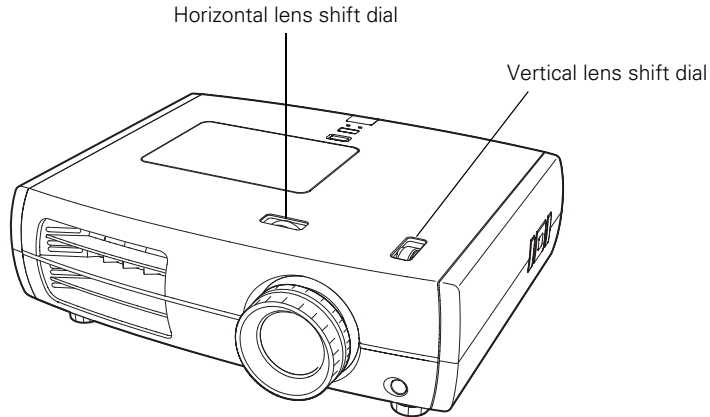

Note: You can display a test pattern to help adjust the image position by pressing the **Pattern** button on the remote control. Press the **Pattern** button again to turn off the test pattern.

When you hear a click, the lens position is almost centered. If the lens shift dial becomes difficult to turn, you cannot adjust the position any further.

If one side of the image is taller than the other, make sure the projector is parallel to the screen. If necessary, adjust the front feet so that the projector is horizontal.

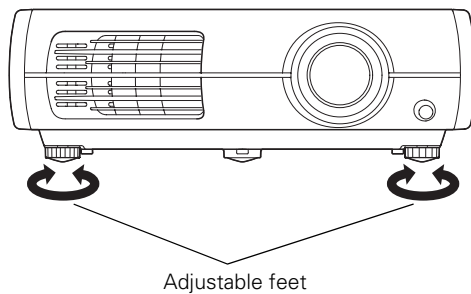

The image cannot be moved to the maximum distance in both the vertical and horizontal directions. For example, the image cannot be shifted vertically when it has been shifted horizontally by the full amount. When the image has been shifted vertically by the full amount, it can be shifted up to 9 percent of the width of the image. The amount by which you can shift the image is expressed in terms of the image width (W) and height (H), as shown below:

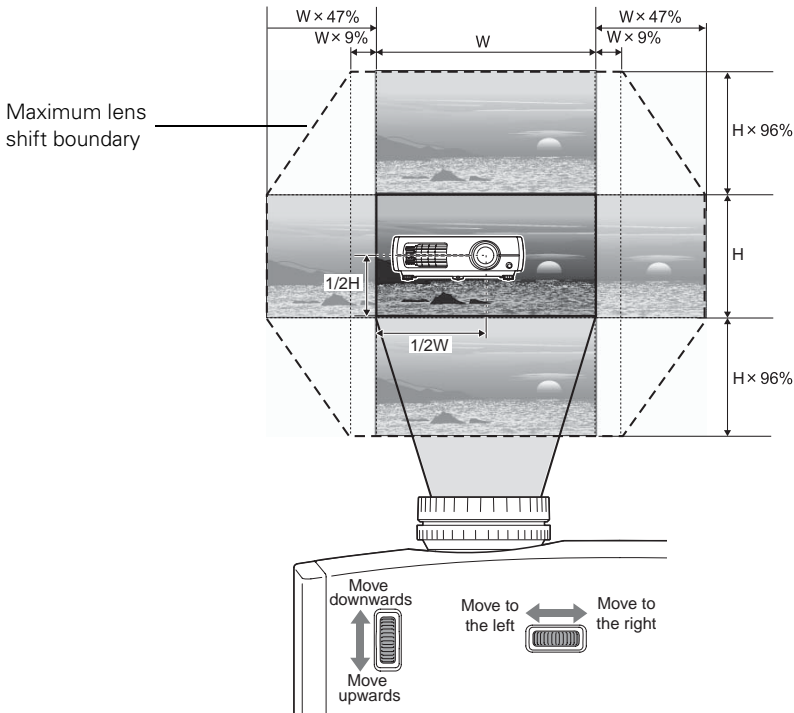

Making Basic Adjustments

Follow the instructions in this chapter to make basic adjustments to the image shape, size, color, and quality. For further refinements, see “Making Detailed Adjustments” on page 33.

Focusing and Zooming

Use the focus ring to sharpen the image.

Use the zoom ring to reduce or enlarge the image.

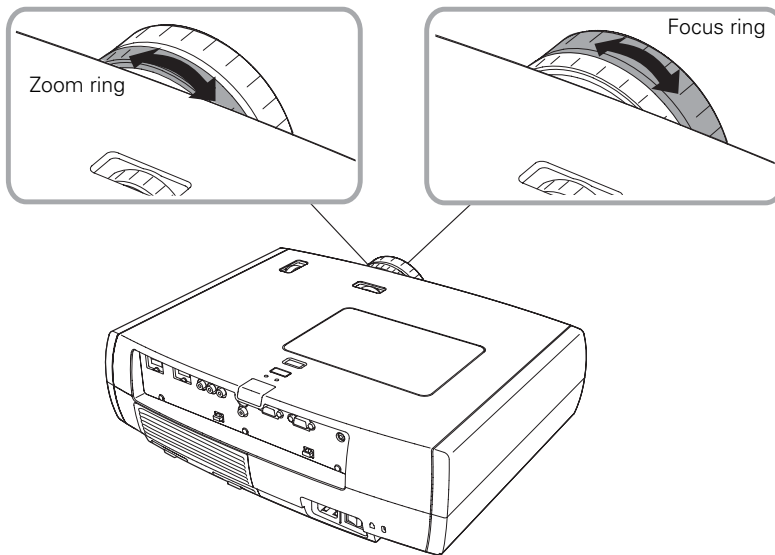

Choosing the Aspect Ratio

In many cases, video signals are automatically resized to fit on your screen when **Auto** is selected as the Aspect setting. You may need to change the size of the image (or aspect ratio) for certain image types by pressing the **Aspect** button on the remote control.

Select one of these settings:

- **Normal** for standard TV broadcasts, computer images, or images with a 4:3 aspect ratio.
- **Full** for images recorded in squeeze mode.
- **Zoom** for images recorded in 16:9 (wide-screen) format.

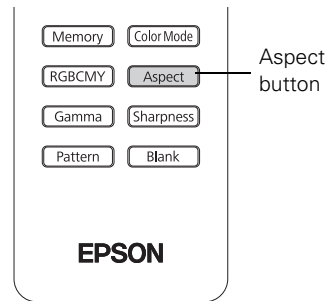

4:3 image using Normal setting



16:9 image using Zoom setting



- **Wide** for expanding a 4:3 image to 16:9 so it fills the whole screen. This stretches only the right and left sides of the image; the central part is unchanged.

Note: When displaying 720p, 1080i, or 1080p signals through the HDMI or Component video port, the aspect ratio is automatically selected and you cannot change it.

If you display a 4:3 image using the Zoom setting, the top and bottom will be cut off. You can use the Zoom Caption Pos. option and other settings to resize and reposition the image. For details, see page 45.

For details on how the projector resizes the picture when you choose an Aspect setting, see page 65.

Choosing the Color Mode

You can change the Color Mode to automatically adjust brightness, contrast, and color, letting you quickly optimize the projected image for various lighting environments. You can also select a different color mode for each input source—which is useful if you view different types of images from different sources. (For example, you might set the HDMI 1 source to **Living Room** if it's usually used for watching movies in the daytime with the blinds closed, and the PC source to **Dynamic** for playing video games with the blinds open.)

Select the image source you want to adjust, then press the **Color Mode** button on the remote control. Choose from these settings:

- **Dynamic** for projecting the brightest picture available.
- **Living Room** for watching television programs during the day.
- **Natural** for projecting natural, accurate colors in a dimly lit room.
- **Cinema** for viewing movies in a dimly lit room.
- **x.v.Color** for the most natural color reproduction when viewing movies through HDMI.

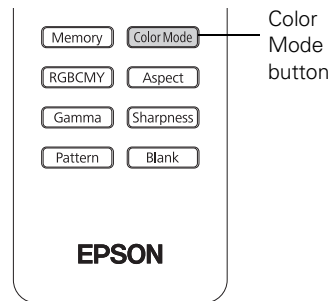

The built-in Epson Cinema Filter automatically improves color reproduction in a darkened room; it is not used when you select **Dynamic** or **Living Room**.

Advanced Color Adjustments

To further customize the color and image quality, you can adjust the gamma and individual RGBCMY color tones using the RGBCMY and Gamma buttons on the remote control (not available when x.v.Color is selected as the Color Mode).

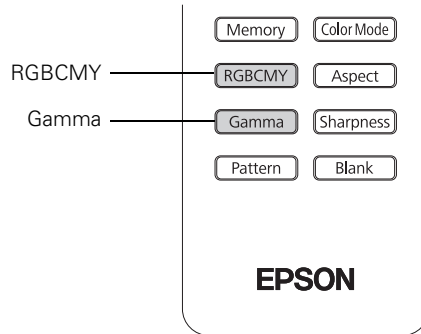

Note: You can fine-tune these and other color and image quality settings using the projector's menu system (see page 33). You can also save combinations of picture settings with the Memory feature for easy recall (see page 42). If you don't like the settings you have selected on a particular menu screen, you can press the Default button to restore the factory settings.

Adjusting the Gamma Setting

You can select from five gamma settings (2.0 to 2.4) or customize your own setting from your image or a displayed graph. Lower values will increase the contrast of dark areas, but tend to blur the bright areas. Higher values will darken the light areas. Gamma presets make minor adjustments to mid-tone values. The larger the gamma preset, the lower the midtone values. Changing these settings affects contrast which can be seen as a blur in bright areas.

Note: This setting cannot be used when the Color Mode is set to x.v.Color (see page 28).

1. Press the **Gamma** button. You see the following displayed on the screen:

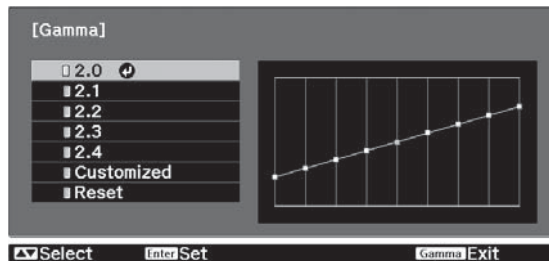

2. Do one of the following:

- Select one of the numeric correction values using the ▲ or ▼ button on the remote control and press the **Enter** button. You see the setting reflected in the graph on the right. The horizontal axis represents the input signal level, and the vertical axis represents the output signal level. Press the **Gamma** button to exit.
- Select **Customized**. Then continue with the next step.

3. Do one of the following:

- Select **Adjust it from the image**. You see a gamma icon on the projected image. Use the arrow buttons to move the icon to the area of brightness you want to adjust, then press **Enter**. The custom gamma graph appears with the channel selected for adjustment. Press the ▲ or ▼ button to adjust and then press **Enter**.
- Select **Adjust it from the graph**. When the gamma graph appears, use the ◀ or ▶ button to select the point on the graph that you want to adjust, and then use the ▲ or ▼ button to adjust the settings. Press **Enter** to save your setting and exit.

Adjusting RGBCMY

Use this feature to adjust the hue, saturation, and brightness for each of the red (R), green (G), blue (B), cyan (C), magenta (M), and yellow (Y) color components.

Note: This setting cannot be used when the Color Mode is set to x.v.Color (see page 28).

1. Press the RGBCMY button. You see the following displayed on the screen:

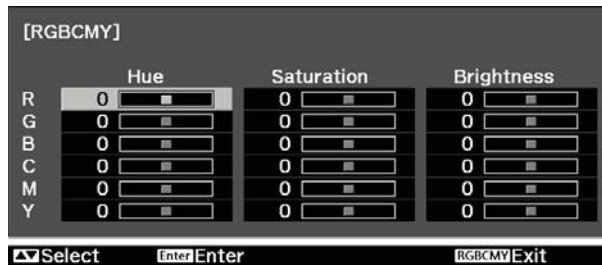

2. Use the ▲ or ▼ button on the remote control to select the color you want to adjust, and press the Enter button.
3. Select the Hue, Saturation, or Brightness for that color, and use the ◀ or ▶ button to make the adjustment.
4. Press Esc to adjust another color, or press RGBCMY to exit.

Note: You can also adjust the offset and gain using the RGB setting in the projector's menu system (see page 40).

Locking the Projector

The projector includes two lock settings to prevent the image from being accidentally changed once it's adjusted, and to keep children from turning on the projector without adult supervision.

To access the lock settings, follow these steps:

1. Press the **Menu** button on the remote control.
2. Use the menu navigation buttons to open the **Settings** menu.
3. Choose from these options:

- **Child Lock** to disable the **Power** button on the projector's control panel unless it is pressed for about 3 seconds. (You can use the **Power** button to turn it off, however.) Since you can still use the remote control to turn on the projector, you may want to keep it away from children's reach.
- **Control Panel Lock** to disable all the buttons on the projector's control panel. A lock icon appears on the screen whenever you press a button with Control Panel Lock turned on. To operate the projector, you must use the remote control. To cancel Control Panel Lock, press and hold the **Enter** button on the projector's control panel for at least 7 seconds.

4. Press **Menu** to exit the menu system.

If you turned on the Control Panel Lock, the projector buttons are now locked.

If you turned on the Child Lock, turn off the projector and let it cool down. The Child Lock takes effect after the cool-down period.

Caution: If the Direct Power On setting is turned on (see page 46), using the main power switch can cause the projector to start even though the Child Lock is in use.

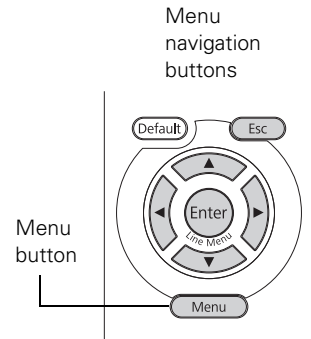

Making Detailed Adjustments

You can use the projector's on-screen menus to make detailed adjustments to the image quality—such as the brightness, contrast, sharpness, and color. You can also change the menu display, sleep mode settings, and other projector features.

Using the Menu System

You can access the menu system either from the remote control or the buttons on the projector's control panel. You can access the full menu or a line menu that lets you change selected settings. You can also change the menu language and control how the menus display (see page 35).

Note: If you press **Blank** on the remote control while a menu is being displayed, the menu screen disappears. This is useful for checking the effects of your image adjustments. Press **Blank** again to make the menu reappear.

To display the full menu, press the **Menu** button on the projector or remote control. You see a display like this one:

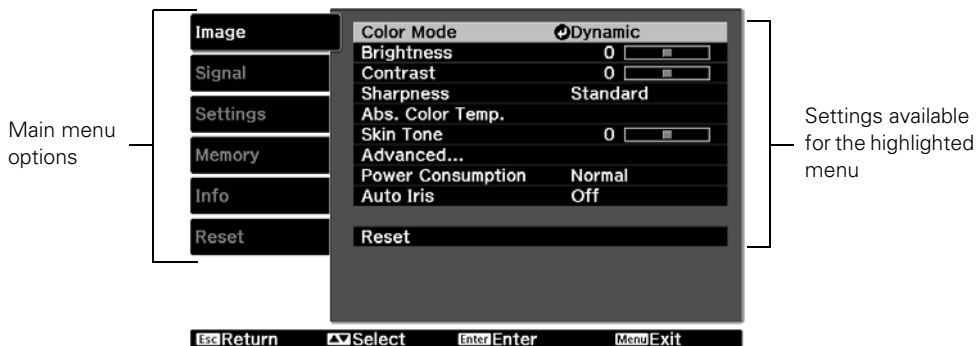

Note: You may see different options, depending on how your equipment is connected to it.

1. Press the ▲ or ▼ button to highlight a main menu option (Image, Signal, Settings, Memory, Info or Reset), then press the Enter button to select it.
2. Press the ▲ or ▼ button to highlight a setting, then press the Enter button.

3. Press the ▲, ▼, ◀, or ▶ button to change settings as necessary. You may have to press the **Enter** button to confirm your choice.
4. When you're finished, press the **Esc** button to return to the previous menu or press the **Menu** button to exit the menu system.

To display one of the line menus, press the **Enter** button. You see a display like this at the bottom of the image:

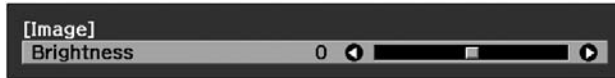

1. Press the ▲ or ▼ button to select the setting you want to adjust:
 - Brightness (see page 36)
 - Contrast (see page 36)
 - Sharpness (see page 37)
 - Color Saturation (see page 39)
 - Tint (see page 39)
 - Absolute Color Temperature (see page 39)
 - Skin Tone (see page 39)
2. Press the ◀ or ▶ button to adjust the setting.
3. Press the **Menu** or **Esc** button to close the line menu when you're done.

Note: When a line menu is displayed, you can press **Default** on the remote control to reset the menu to its factory setting.

Changing How the Menus Display

Use these options to control how the menus display.

■ Language

Settings > Language

Select from 21 languages to use in the menu system.

■ Menu Position

Settings > Display > Menu Position

Use the arrow buttons to choose a position on the screen for displaying the menu.

■ Menu Color

Settings > Display > Menu Color

Select a color scheme for displaying the menus.

Adjusting the Picture Quality

Before fine-tuning the image using these adjustments, make sure you have already selected the best Color Mode for your picture and viewing environment, as described on page 28. Then use the settings in this section to finish adjusting the picture to your liking.

Most image quality settings are saved independently for each input source (Video, S-Video, HDMI, Component, PC) and color mode. After you finish adjusting the settings for one input source, switch to the other input sources you'll be using and make any necessary adjustments.

Input Brightness Settings

If the signal from connected equipment is weak and images appear dark, you can adjust the Brightness and Contrast settings. You can adjust brightness and contrast for each image source and color mode.

The Brightness setting controls how much light is produced by the projector, and the Contrast setting adjusts the difference between the bright and dark areas of the projected image. The other settings in this section control how the projector interprets the light and dark areas of the picture.

■ Brightness

Image > Brightness

Note: This setting cannot be used when the Color Mode is set to x.v.Color (see page 28).

Adjust the brightness so it's suitable for your viewing conditions. For example, if you're projecting in a brightly lit room or onto an especially large screen, you may need to increase the brightness. Decrease the brightness for dark rooms or small screens; this also reduces power consumption and fan noise, and helps to prolong the life of the lamp.

■ Contrast

Image > Contrast

Note: This setting cannot be used when the Color Mode is set to x.v.Color (see page 28).

This setting adjusts the difference between bright and dark areas.

■ Auto Iris

Image > Auto Iris

Note: This setting cannot be used when the Color Mode is set to x.v.Color (see page 28).

When this setting is on, the light output is automatically adjusted according to the brightness of the image. Select either **Normal** or **High Speed** to indicate how quickly you would like the projector to respond to changes in the brightness of the image. The setting is stored separately for each image source and color mode.

■ Setup Level

Signal > Advanced > Setup Level

Note: This setting can be used only when an NTSC signal is being input through the Video or S-Video port, or when a video signal is being input through the Component video ports.

This setting adjusts the threshold at which dark areas of the image are rendered black (0 IRE). For compatibility with most DVD and video equipment sold in the United States, leave this setting at 0%. Check your video equipment's specifications to be sure of the correct setting.

■ EPSON Super White

Signal > Advanced > EPSON Super White

Note: This setting can be used only when the signal is input through the HDMI 1 or HDMI 2 ports with the Color Mode set to Natural or Cinema (see page 28).

If bright parts of the image are washed out or overexposed (when the input signal contains values over 100 IRE), turn this setting on to compensate.

■ HDMI Video Range

Signal > Advanced > HDMI Video Range

Note: This setting can be used only when HDMI 1 or HDMI 2 is selected as the image source (see page 23). This setting cannot be used when the Color Mode is set to x.v.Color (see page 28).

If your video equipment has an HDMI port and you've connected it to the projector using an HDMI cable, set the level of the projector to match that of the video equipment.

■ Power Consumption

Image > Power Consumption

This setting controls the light output from the projector. On **Normal**, the projector produces a brighter image and the lamp uses more power. To save power and extend the life of the lamp, select **ECO**.

Sharpness and Picture Quality Settings

If the image looks fuzzy, or if it contains noise or flickering, you can use these settings to correct it.

■ Sharpness

Image > Sharpness

Use this function to make lines and edges appear more distinct in the image. This setting is stored separately for each image source and color mode setting. You can select **Standard** to adjust the sharpness of the entire image, or select **Advanced** to access the following submenu:



Note: The Advanced setting cannot be used with a signal input through the PC port.

Choose **Thin-Line Enhancement** to sharpen details such as hair and clothing. Choose **Thick-Line Enhancement** to sharpen large contours and backgrounds. Choose **Vert. Line Enhancement** to increase vertical image sharpness. Choose **Horiz. Line Enhancement** to increase horizontal image sharpness.

You can also access this setting by pressing the **Sharpness** button on the remote control.

■ Progressive

Signal > Progressive

Note: This setting can be used only when viewing composite video or S-video signals, or 480i, 576i, or 1080i signals input through the Component, HDMI 1, or HDMI 2 ports (see page 65).

Converts interlaced to progressive signals. The projector uses 3D DigiScan™ HD Circuitry Processing for video-sourced images. For film-sourced images, you can select from 2-2 or 2-3 pulldown detection (see below).

Leave the setting on **Film/Auto** for viewing movies on a player that produces interlaced output. Select **Video** for watching videos captured with a video camera. Set to **Off** when viewing images with a large amount of movement.

■ Motion Detection

Signal > Motion Detection

Note: This setting can be used only when viewing composite video or S-Video signals, or 480i or 576i, or 1080i signals input through the Component, HDMI 1, or HDMI 2 ports (see page 65).

This setting specifies how signals are converted to progressive signals. Select a lower setting for slow-moving or still images (**S**) or select a higher number for video images (**M**).

■ Noise Reduction

Signal > Advanced > Noise Reduction

Note: This setting cannot be used with a signal input through the PC port.

This setting reduces flickering of analog images. You can select from 3 levels of noise reduction.

■ 2-2 Pull-down

Signal > 2-2 Pull-down

Note: This setting can be used only when viewing a 1080p/24Hz signal input through the Component, HDMI 1, or HDMI 2 ports (see page 65). This setting cannot be used with a signal input through the PC port.

This setting allows you to select whether images are projected with 2-2 pulldown detection or 2-3 pulldown detection. Select **On** for 2-2 pulldown detection.

Color Settings

If the image colors don't look correct, you can adjust them using these settings. Use the first three settings described below to make the most visible changes. If you only need to make slight adjustments, you can fine-tune the picture with the remaining settings. Most color settings are stored separately for each image source and color mode.

Note: If you're using a commercially available color calibration DVD, you can display a color-bar test pattern and then filter colors in the image by pressing the **Pattern** button. Select one of the **Color Isolation** options for the color you want to filter (R/G/B). This lets you adjust color settings without holding a filter over your eyes while making adjustments. Press the **Esc** button when you're done.

■ Color Saturation

Image > Color Saturation

Note: This setting cannot be used when the Color Mode is set to x.v.Color (see page 28) or with a signal input through the PC port.

Adjusts the color intensity of the image.

■ Tint

Image > Tint

Note: This setting cannot be used when the Color Mode is set to x.v.Color (see page 28) or with a signal input through the PC port.

Shifts the color balance between magenta and green.

■ Abs. Color Temp.

Image > Abs. Color Temp.

Note: This setting cannot be used when the Color Mode is set to x.v.Color (see page 28).

Shifts the color balance between red and blue, making the image appear warmer or cooler.

■ Skin Tone

Image > Skin Tone

Note: This setting cannot be used when the Color Mode is set to x.v.Color (see page 28).

Makes fine adjustments to the tint and controls the amount of magenta or green in the image. Also useful for correcting black-and-white images, if they look tinted.

■ RGB

Image > Advanced > RGB

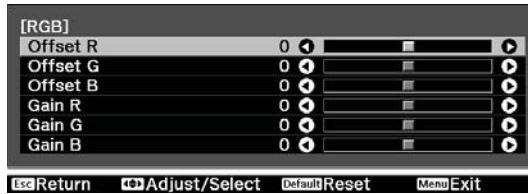

Note: This setting cannot be used when the Color Mode is set to x.v.Color (see page 28).

Use the RGB settings to fine-tune the color of the image. You can adjust the offset and gain for each signal color (red, green, and blue). Use **Offset** to adjust darker shades and **Gain** for the lightest shades.

■ RGBCMY

Image > Advanced > RGBCMY

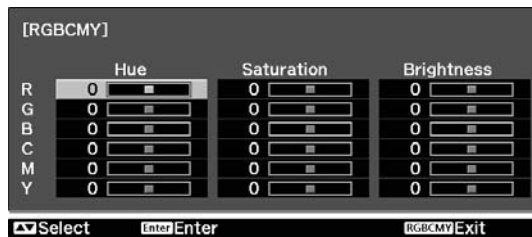

Note: This setting cannot be used when the Color Mode is set to x.v.Color (see page 28).

Use the RGBCMY settings to adjust the hue, saturation, and brightness of the six color components (red, green, blue, cyan, magenta, yellow). After adjusting each color, press **Esc** to move to another menu option. You can also access this setting by pressing the RGBCMY button on the remote control. See page 31 for more information.

■ Gamma

Image > Advanced > Gamma

Note: This setting cannot be used when the Color Mode is set to x.v.Color (see page 28).

You can select from five gamma settings (2.0 to 2.4) or customize your own setting from your image or a displayed graph. Lower values will increase the contrast of dark areas, but tend to blur the bright areas. Higher values will darken the light areas.

You can also access this setting by pressing the **Gamma** button on the remote control. See page 30 for more information.

Adjustments for Computer Images

In addition to the settings described previously, you can adjust the Tracking and Sync settings for analog RGB computer images. Normally, these settings are adjusted automatically by the projector. If you notice that the image is blurry or contains dark vertical bands, you may need to adjust the settings yourself.

■ Auto Setup

Signal > Auto Setup

Leave this setting on so that the projector automatically adjusts the tracking, sync, and position of the image.

■ Tracking

Signal > Tracking

Adjust the tracking to eliminate vertical bands. It is easiest to adjust the tracking when the image contains a lot of fine detail (such as black text on a white background).

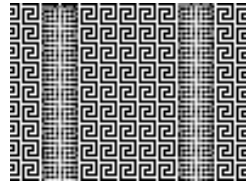

■ Sync.

Signal > Sync.

Adjust the synchronization to eliminate blurriness. For best results, make sure the tracking is properly adjusted first.

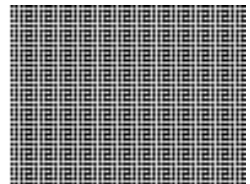

Selecting Memory Settings and Resetting the Projector

Your projector comes with 10 memory locations where you can save customized settings to obtain the best picture quality for each of your video inputs.

Selecting Memory Settings

You can easily recall the memory settings by using the memory button on the remote control.

1. Press the **Memory** button on the remote control.
2. Select **Load Memory**.
3. Use the arrow buttons to select the desired setting, then press the **Enter** button.

After a moment, the image appears on the screen using the retrieved settings. Certain settings may not be applied, depending on the input signal.

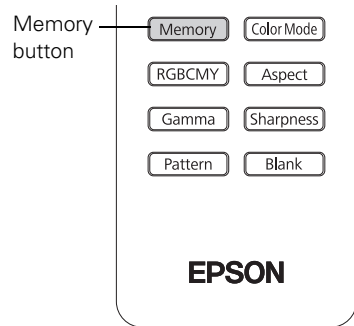

Creating Memory Settings

Memory settings can be used to store most of the picture quality settings on page 37 and color settings on page 39. Before saving them to memory, adjust the settings to the desired levels.

1. Press the **Memory** button on the remote control.
2. Select **Save Memory**.
3. Select the memory name you want to use, then press the **Enter** button to save your settings.

Note: Saved settings are indicated by a green highlight  next to the memory name. If you select a name that is already in use, the existing settings will be erased and new ones saved in their place.

Deleting Saved Memory Settings

You can clear all your memory settings at once.

1. Press the **Menu** button on the remote control.
2. Open the **Reset** menu, then select **Reset Memory**.
3. Select **Yes**, then press the **Enter** button to delete the memory settings.

Note: You can delete memory settings one at a time with the **Erase Memory** setting under the **Memory** menu.

Resetting the Projector

If the image quality isn't what you expect, one or more settings may be adjusted improperly. If necessary, you can restore the projector to its factory-default (original) settings.

To restore the settings in a specific menu (such as the Image or Settings menu), open that menu, select **Reset**, and confirm as needed. The example below shows how to reset the Image menu settings:

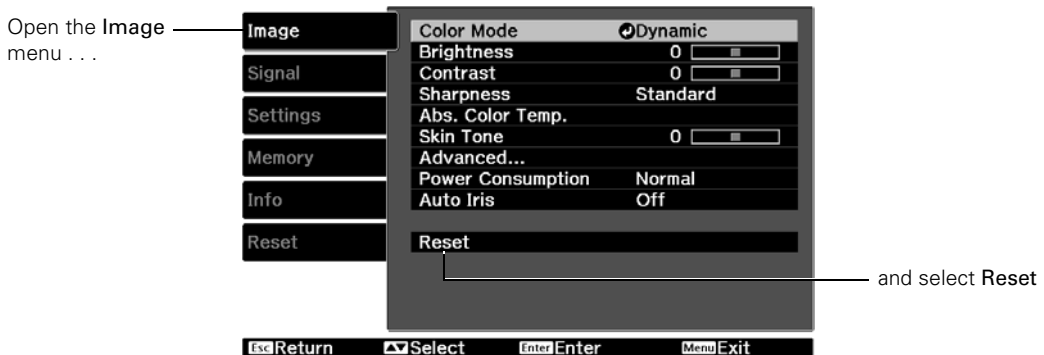

You can also reset the lamp usage timer or restore all the projector settings to their original values. Follow these steps:

1. Press the **Menu** button on the remote control.
2. Open the **Reset** menu.

3. Do one of the following:
 - Select **Reset Lamp Hours** to clear the lamp usage timer and reset it to zero. You should reset the lamp timer only when you install a new projector lamp. See page 54 for more information.
 - Select **Reset Memory** to clear all memory settings.
 - Select **Reset All** to return all projector settings to their original defaults (except Component, Save Memory, Language, and Lamp Hours).

Customizing Projector Features

Use the settings in this section to adjust the image size and position, suppress on-screen text, and select basic setup options.

Image Sizing

Before adjusting any of these settings, make sure you have already selected an appropriate aspect ratio for the type of picture you're viewing (see page 27).

■ Overscan

Signal > Advanced > Overscan

For component video formats, this setting lets you see the edges of the image that are not normally visible in the picture (see page 65). If you see interference when you set **Overscan** to 100%, try adjusting the **Position** as described below.

■ Position

Signal > Position

Note: This setting cannot be used with a signal input through the HDMI 1 or HDMI 2 port.

Use the arrow buttons to fine-tune the position of the image on the screen.

■ Aspect

Signal > Aspect

This setting lets you change the aspect ratio of your image, and works the same as pressing the **Aspect** button on the remote control. See page 27 for more information.

■ Zoom Size

Signal > Zoom Size

Lets you reduce the image size in the vertical direction so that the top and bottom of the image are visible (available only if the aspect ratio has been set to **Zoom**).

■ Zoom Caption Pos.

Signal > Zoom Caption Pos.

Lets you adjust the position of the image so that subtitles are visible (available only if the aspect ratio has been set to **Zoom**). Use **Zoom Caption Pos.** to move the image up or down. Adjust overscan before changing the zoom position.

Screen Options

■ Messages

Settings > Display > Messages

Turn this setting off if you want to prevent on-screen messages from appearing (such as the no-signal message, or the identifying text that appears when you switch between image sources or color modes).

■ Startup Screen

Settings > Display > Startup Screen

Turn this setting off if you want to prevent the startup screen from appearing while the projector is warming up.

■ Display Background

Settings > Display > Display Background

Changes the screen that's used when the projector is not receiving a signal or when you press the **Blank** button to temporarily stop projection.

Other Setup Options

■ Projection

Settings > Projection

You can select different options for projecting the image: **Front**, **Front/Ceiling**, **Rear**, **Rear/Ceiling**.

■ Direct Power On

Settings > Direct Power On

Sets projection to start when the main power switch is turned on, without pressing the  power button on the remote control or the projector.

Note: When direct power on is enabled, power surges that occur after a power outage can cause the projector to turn on.

■ Video Signal

Settings > Input Signal > Video Signal

Leave this setting on **Auto** so the projector can automatically interpret the format, such as NTSC or PAL (for standard TV formats).

■ Component

Settings > Input Signal > Component

Change this setting to match the type of equipment connected to the Component port. For component video, select **Auto** to let the projector automatically interpret the signal; or select YCbCr or YPbPr to manually select your video equipment's signal.

■ Trigger Out



Settings > Trigger Out

Turn on this setting to have the **Trigger out** port output a 12-volt signal to lower your projection screen when the projector is running.

Note: If you change this setting, the new setting will take effect the next time you turn the projector on.

■ Illumination

Settings > Illumination

Turn off this setting to deactivate the lights on the projector's  power and  source buttons. Use this setting if you find the lights distracting in a darkened room.

■ Sleep Mode

Settings > Sleep Mode

Turn off this setting if you don't want the projector to enter sleep mode. (Sleep mode shuts the projector off automatically when there is no video signal.)

Select **5min.**, **10min.**, or **30min.** as the length of time before shutoff; decreasing the time conserves power and extends the life of the lamp.

To turn the projector back on, press the  power button on the remote control or the projector.

■ Child Lock

Settings > Child Lock

Lets you lock the  power button on the projector's control panel to make it more difficult for a child to turn on the projector. See page 32 for more information.

■ Control Panel Lock

Settings > Control Panel Lock

Lets you disable all the buttons on the projector's control panel to prevent the image from being accidentally changed once it is adjusted. See page 32 for more information.

■ High Altitude Mode

Settings > High Altitude Mode

Adjusts the speed of the fan so it can properly cool the projector at higher altitudes. Turn this setting on if you are using the projector at an altitude of 4921 feet (1500 meters) or higher.

Maintenance

Your projector needs little maintenance. All you need to do on a regular basis is keep the lens clean. You also may need to clean the air filter to prevent overheating.

WARNING: Before you clean any part of the projector, turn it off and unplug the power cord. Never open any cover on the projector, except the lamp and filter covers. Dangerous electrical voltages in the projector can injure you severely. Do not try to service this product yourself, except as specifically explained in this *User's Guide*.

The only parts you should replace are the air filter and the lamp. If another part needs replacing, contact your dealer or a qualified servicer.

Cleaning the Lens

Clean the lens whenever you notice dirt or dust on the surface.

- Use a blower brush that is designed for camera equipment to remove dust from the lens.
- To remove dirt or smears, use a lens cloth or tissue. If necessary, moisten the cloth with lens cleaner and gently wipe the lens surface.

Caution: Never rub the lens with abrasive materials. Use only lens cleaning fluids that are designed for cleaning optics.

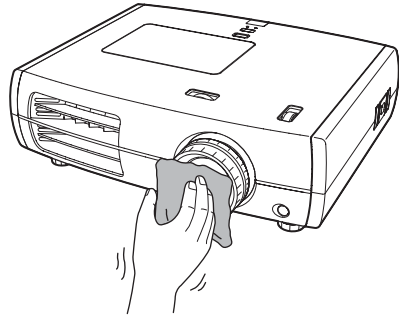

Cleaning the Projector Case

Before you clean the case, turn off the projector and unplug the power cord.

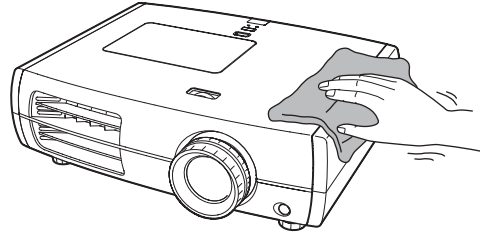

- To remove dirt or dust, wipe the case with a soft, dry, lint-free cloth.
- To remove stubborn dirt or stains, moisten a soft cloth with water and a neutral detergent. Then wipe the case and dry it with a dry cloth.



Caution: Never use wax, alcohol, benzene, thinner, or other chemical detergents. These can damage the case.

Cleaning and Replacing the Air Filter

Your projector includes an air filter to ensure the best performance. If dust collects on the air filter, clean it as described below. Dust clogs prevent proper ventilation and cause overheating and damage to the projector.

1. Press the  power button and wait for the  power light to stop flashing. The projector cools down.
2. Turn off the projector using the power switch on the back.
3. Unplug the power cord and disconnect any cables.
4. Turn the projector over (unless it's ceiling mounted).
5. Push down on the tabs on the filter cover to remove it.

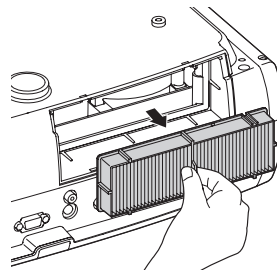
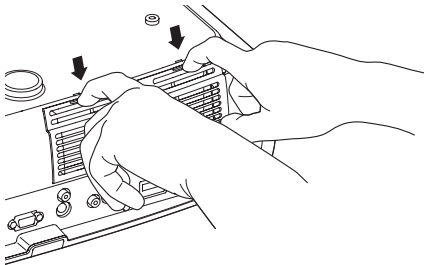

6. Remove the air filter as shown.

7. Gently tap both sides of the air filter against a hard surface four or five times to remove loose dust from the air filter.

Note: Do not tap the filter too hard. This can cause it to bend or break.

8. Use a small vacuum cleaner that is designed for computers and other office equipment to remove any remaining dust from the surface of the filter. If you don't have one, gently clean the filter using a very soft brush (such as a clean artist's paintbrush).

If the dirt is difficult to remove or the filter is broken, replace it. You can purchase air filter part number V13H134A21 from an authorized Epson reseller. To find the nearest reseller, please call 800-GO-EPSON (800-463-7766). To purchase online, visit www.epsonstore.com (U.S. sales) or www.epson.ca (Canadian sales).

9. Insert the air filter as shown with the groove on the right.

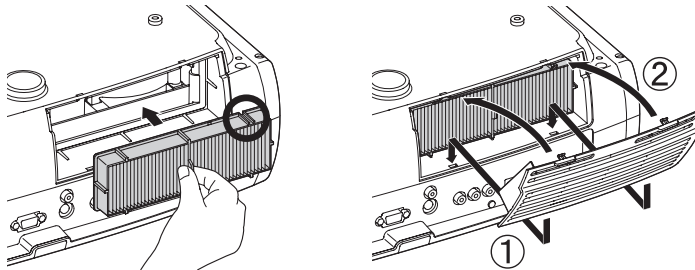

10. Reattach the air filter cover by inserting the tabs as shown and pressing the cover against the projector until it clicks into place.

Replacing the Lamp

The projection lamp lasts for up to 4000 hours. You can use the Info menu to check how long it's been in use (see page 54). It's time to replace the lamp when:

- The projected image gets darker or starts to deteriorate.
- The projector's lamp light flashes red at half-second intervals.
- The message **Replace the lamp** appears on the screen when you start projecting.

Note: Lamp life results will vary depending on mode selected, environmental conditions, and usage.

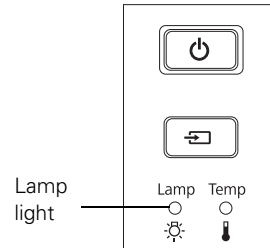

Turn off this product when not in use to prolong the life of the projector.

You can purchase lamp part number V13H010L49 from an authorized Epson reseller. To find the nearest reseller, please call 800-GO-EPSON (800-463-7766). To purchase online, visit www.epsonstore.com (U.S. sales) or www.epson.ca (Canadian sales).

Be sure to read the “Important Safety Information” on page 68 before replacing the lamp.

WARNING: Let the lamp cool fully (about 1 hour) before replacing it. In the unlikely event that the lamp has broken, small glass fragments may be present and should be removed carefully to avoid injury.

Caution: Never touch the glass portion of the lamp with your bare hands; the invisible residue left by the oil on your hands may shorten the lamp life. Use a cloth or glove to handle the new lamp.

Follow these steps to replace the lamp:

1. If the projector is on, press the  power button and wait for the light to stop flashing.
2. Turn off the power switch on the back of the projector.
3. Unplug the power cord and any cables.
4. Wait about an hour to make sure the lamp is no longer hot.

5. Insert the screwdriver that came with the lamp (or a similar tool) into the slot on the back of the projector to release the lamp cover. Then lift up the cover to remove it.

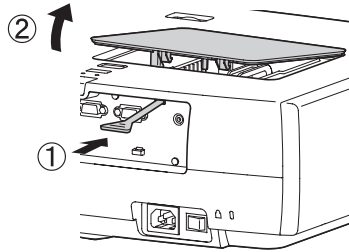

6. Loosen the two screws securing the lamp (they don't come all the way out).

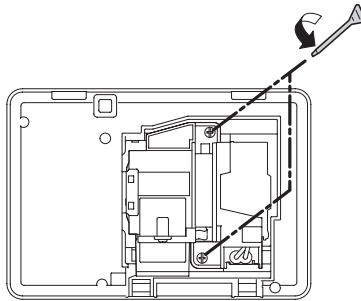

7. Grasp the lamp as shown and pull it straight out.

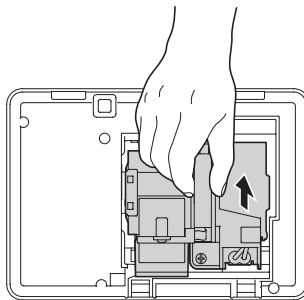

WARNING: (Hg) The lamp(s) in this product contain mercury. Please consult your state and local regulations regarding disposal or recycling. Do not put in the trash.

8. Gently insert the new lamp and tighten its screws.

Caution: Don't touch the glass portion of the lamp assembly. Touching the glass could result in premature lamp failure.

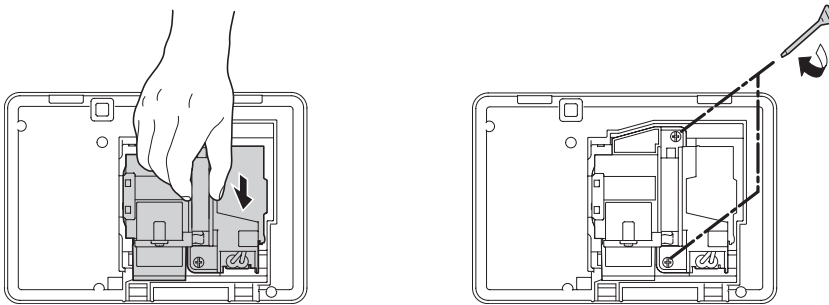

9. Replace the lamp cover. (The projector won't work if the lamp cover is open or loose.)

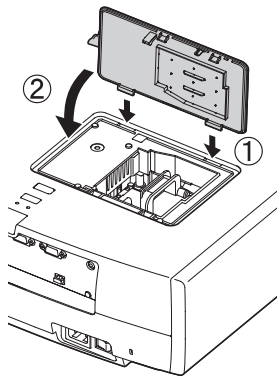

10. Reset the lamp usage timer, as described on page 54.

Resetting the Lamp Usage Timer

After replacing the lamp, plug the projector back in, turn on the power switch on the back, and press the  power button. Then follow these steps to reset the lamp usage timer:

1. Press the **Menu** button on the projector or remote control.
2. Use the menu navigation buttons to open the **Reset** menu, then select **Reset Lamp Hours**.
3. When you see a confirmation prompt, highlight **Yes** and press the **Enter** button.
4. When you're finished, press the **Menu** button to exit.

The lamp usage timer shows 0H until you've used the lamp for at least 10 hours.

Checking the Projector Status

You can use the Info menu to view information about the current display settings and how long the projection lamp has been in use. To access the Info menu:

1. Press the **Menu** button on the projector or remote control.
2. Use the menu navigation buttons to open the **Info** menu. The following information appears:

- | | |
|----------------|------------------------------|
| ■ Lamp Hours | ■ Refresh Rate |
| ■ Source | ■ Sync Info |
| ■ Input Signal | ■ Video Signal |
| ■ Resolution | ■ Deep Color (color depth) |
| ■ Scan Mode | ■ Status (error information) |

Note: The information displayed depends on the currently selected image source. The Lamp Hours shows 0H until you've used the lamp for at least 10 hours.

The resolution indicates the total number of scan lines in the source signal. The number of visible scan lines depends on the signal format standard and selected display settings (see page 65).

Storing the Projector

If you need to store the projector for an extended time, do the following:

- Make sure the temperature of the storage area is within 14 to 140 °F (–10 to 60 °C).
- Attach the lens cover and retract the feet.
- Remove the batteries from the remote control.
- Pack the projector in its original packaging or equivalent.

Transporting the Projector

Note: Epson shall not be liable for any damages incurred during transportation.

The projector contains many glass and precision parts. When shipping the projector for repairs, use the original packaging material if possible. If you do not have the original packaging, use equivalent materials. Do not use materials that can become lodged in the projector vents. Be sure the carrier is capable of transporting fragile equipment and is aware that the projector is fragile.

Before transporting the projector, make sure you center the lens from left to right by turning the horizontal lens shift dial until it clicks. Then lower the lens all the way down by turning the vertical lens shift dial until it stops.

Caution: Do not try to move the lens by hand, or you may damage the projector. Always use the lens shift dials to change the lens position. If the lens shift dial becomes hard to turn, you cannot adjust the position any further.

Problem Solving

This section explains how to interpret the projector's status lights, solve problems with the picture and remote control, and contact technical support.







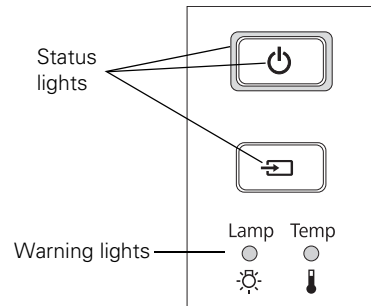

What To Do When the Lights Come On or Flash

The lights on top of the projector indicate the projector's status and let you know when a problem occurs.







If the projector isn't working correctly, first press the  power button, let the projector cool down, turn off the power switch on the back, and unplug the power cord. Then plug the power cord back in and turn on the projector. If this doesn't solve the problem, check the status lights on top of the projector.



Lights indicating normal operation

Light state	Cause and solution
All lights are off	The projector is turned off. If necessary, connect the power cord and turn on the power switch on the back of the projector.
 Power light is on	The projector is in standby (sleep) mode. Turn off the power switch in back to turn off the projector, or press the  power button to turn it on.
 Power light flashes and  source light is on	The projector is warming up. Wait for the picture to appear.
 Power light and  source light are on	Projection is in progress.
 Power light flashes; no other lights are on	The projector is cooling down. Wait until the light stops flashing and remains on. Then turn off the power switch in back to turn off the projector, or press the  power button to turn it back on.



Lights indicating a problem

Light state	Cause and solution
All lights are off	The projector is not receiving power. Make sure the power switch on the back of the projector is turned on and the power cord is connected securely at both ends.
 <p>The temperature light flashes orange and the power light is flashing</p>	<p>High-speed cooling is in progress. If the temperature rises further, projection will stop automatically. Make sure there is plenty of space around the projector for ventilation. Clean or replace the air filter if necessary (see page 49).</p> <p>If you are using the projector at an altitude above 4921 feet (1500 meters), turn on High Altitude Mode so the fan can cool the projector properly (see page 47).</p>
 <p>The temperature light is red</p>	<p>The projector is too hot, which turns off the lamp automatically. Let the projector cool for five minutes, then turn it back on. Make sure there is plenty of space around the projector for ventilation. Also, clean or replace the filter if necessary (see page 49).</p> <p>If you are using the projector at an altitude above 4921 feet (1500 meters), turn on High Altitude Mode so the fan can cool the projector properly (see page 47).</p>
 <p>The lamp light flashes orange and the power light is flashing</p>	The lamp needs to be replaced soon (see page 51). Make sure you have a spare lamp handy. If you just replaced the lamp, you may need to reset the lamp usage timer (see page 54).
 <p>The lamp light flashes red</p>	The lamp needs to be replaced. If you just replaced the lamp, make sure the lamp and its cover are securely installed (see page 51). Clean the air filter if necessary (see page 49).
 <p>Both warning lights are flashing red</p>	There is an internal problem. Turn off the power switch on the back of the projector, and unplug it from the electrical outlet. Then contact Epson for assistance (see page 62).
 <p>The temperature light flashes red</p>	There is a fan or sensor problem. Turn off the power switch on the back of the projector, and unplug it from the electrical outlet. Then contact Epson for assistance (see page 62).
 <p>Both warning lights are red</p>	There is an internal problem. Turn off the power switch on the back of the projector, and unplug it from the electrical outlet. Then contact Epson for assistance (see page 62).







Note: If the power and source lights don't come on, they may have been turned off using the **Illumination** setting (see page 46).

Solving Picture Problems

You cannot turn on the projector.

- Make sure the power cord is connected and the power switch in back of the projector is turned on. Then wait a moment for the  power light to come on before pressing the  power button.
- If you've set the **Control Panel Lock**, the control panel buttons are disabled; you must use the remote control to turn on the projector (see page 32).
- If you've set the **Child Lock**, you have to press the  power button for 3 seconds to turn on the projector, or use the remote control (see page 32).

No picture appears on the screen or you see the No Signal message displayed.

- Press one of the **Source** buttons on the remote control, or press the  source button on the projector, to select the correct input source. Allow a few seconds for the projector to sync up after pressing the button.
- Press the **Blank** button on the remote control to make sure the picture hasn't been turned off temporarily.
- Check that the  power light is on, the  power light is not flashing, and the lens cover is off.
- The projector may be in standby (sleep) mode. If the  power light is on and the  source light is off, press the  power button to turn the projector back on.
- Make sure your video equipment is turned on.
- Make sure your cable(s) are connected correctly (see page 18).

Only part of the picture is displayed, or the picture is distorted.

- Press the **Aspect** button to select a different aspect ratio (see page 27).
- If the Aspect is set to **Zoom**, you may need to use the **Zoom Caption Pos.** option to see the top or bottom section of the screen so that subtitles are visible (see page 45).
- Check the **Overscan** to make sure it's adjusted correctly (see page 44).
- Use the **Position** setting to reposition the image on the screen (see page 44).
- If you've connected a computer and you see only half the image, make sure the computer's **Dual Display** setting is turned off. If part of the image is cut off, reset the projector settings (see page 43).

You're using a computer and no picture appears on the screen.

If you're using a Windows® laptop:

- Press the function key that lets you display on an external monitor. It's often labeled with an icon such as , but it may also be labeled CRT/LCD. You may have to hold down the Fn key while pressing it. Check your laptop's manual or online help.

On most systems, the  key lets you toggle between the LCD screen and the projector, or display on both at the same time. Allow a few seconds for the projector to sync up after pressing it.

- If the function key doesn't let you display simultaneously on both screens, you might need to use the Display utility in the Windows Control Panel to make sure that both the LCD screen and external monitor port are enabled. From the Windows Control Panel, open the Display utility. In the Display Properties dialog box, click the **Settings** tab, then click **Advanced**. The method for adjusting the setting varies from computer to computer; you may need to click a **Monitor** tab, then make sure the external Monitor port is set as your primary display or enabled. See your computer manual or online help for details.

If you're using Mac OS X:



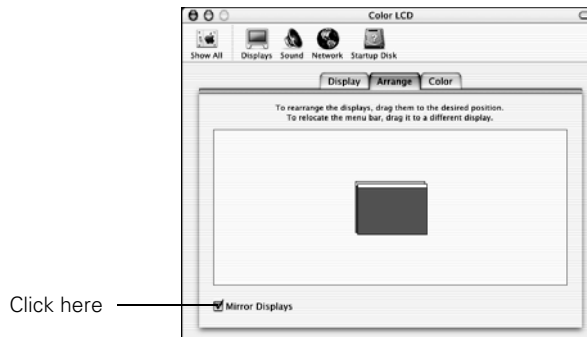

1. Open the **System Preferences** utility and select **Displays**.
2. Select **Detect Displays**.
3. On the **Arrange** or **Arrangement** screen, check the **Mirror Displays** checkbox. (See your computer manual for details.)



The picture is upside-down or reversed.

Change the **Projection** setting in the Settings menu (see page 45).

The picture isn't rectangular.

- If the image looks like  or , the projector has been placed off to one side of the screen and angled toward it. Face the projector straight ahead (instead of at the center of the screen), then use the horizontal lens shift dial to center the image (see page 24).
- If the image looks like  or , make sure the projector is not tilted up or down.

The picture contains static or noise.

- Make sure the **Input Signal** is set correctly for your connected video equipment (see page 46).
- If you're viewing still images and you notice flickering or horizontal lines, turn on the **Progressive** setting (see page 38).
- Make sure your cables are securely connected at both ends.
- If you're using an extension cable, you may pick up interference if the cable is not adequately shielded. You may need to use a signal amplifier for longer cables.
- If you're displaying the same image on your computer and projector screen, try turning off your laptop's LCD display (see page 59).

The picture is blurry.

- Make sure the **Input Signal** is set correctly for your video equipment (see page 46).
- There may be dirt on the lens. Clean the lens as described on page 48.
- Adjust the focus (see page 26).
- Make sure the lens is not fogged by condensation. If you've just moved the projector from a cold environment, wait a couple of minutes before using it.
- Adjust the **Sharpness** setting (see page 37).
- If you're projecting from a computer, you may need to adjust the **Tracking and Sync** settings (see page 41).

The colors on the screen don't look right.

- Make sure the **Input Signal** is set correctly for your connected video equipment (see page 46).
- Press the **Color Mode** button on the remote control to select a different color mode (see page 28).
- Check the brightness and contrast settings (see page 35).

- Fine-tune the colors with the settings listed on page 39.
- If the picture looks dark, you may need to replace the lamp. Check the lamp usage timer to see how long the lamp has been in use (see page 54). Replace the lamp if it's close to the end of its service life (see page 51).

Solving Remote Control Problems

The projector doesn't respond to remote control commands.

- Make sure you're within about 30 feet of the projector, and the remote control is aimed at the projector's front or back sensor within the ranges shown below.

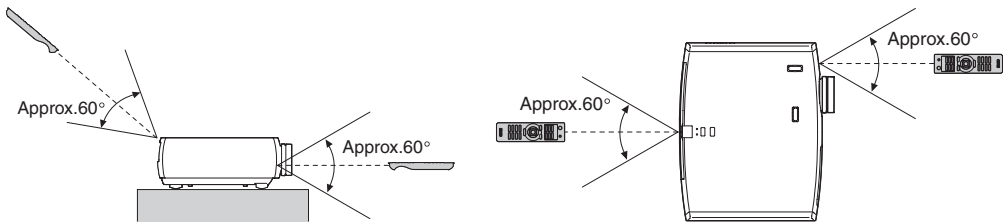

- You may need to replace the remote control batteries (see page 21). Press the  illumination button and check if the buttons glow. If they don't, replace the batteries.
- Dim the room lights and turn off any fluorescent lights. Make sure the projector is not in direct sunlight.
- Turn off nearby equipment that emits infrared energy, such as a radiant room heater.
- Make sure there are no objects between the remote control and the IR receiver.

Where to Get Help

Internet Support

Epson provides technical assistance 24 hours a day at epson.com/support (U.S.) or epson.ca/support (Canada). Here you can access troubleshooting information, download product documentation, and receive technical advice through e-mail.

Speak to a Support Representative

To use the Epson PrivateLine Support service, call (800) 637-7661 and enter the PIN on the Epson PrivateLine Support card that came with your projector. This is the fastest way of speaking to a live representative, and it's free. This service is available 6 AM to 6 PM, Pacific Time, Monday through Friday, for the duration of your warranty period.

You may also speak with a projector support specialist by dialing one of these numbers:

- U.S.: (562) 276-4394, 6 AM to 6 PM, Pacific Time, Monday through Friday
- Canada: (905) 709-3839, 6 AM to 6 PM, Pacific Time, Monday through Friday

Days and hours of support are subject to change without notice. Toll or long distance charges may apply.

Before you call, please have the following information ready:

- Product name (PowerLite Home Cinema 8345)
- Product serial number (located on the bottom of the projector)
- Computer configuration, if you're connected to a computer
- Description of the problem

Purchase Supplies and Accessories

You can purchase screens, carrying cases, or other accessories from an authorized Epson reseller. To find the nearest reseller, call 800-GO-EPSON (800-463-7766). To purchase online, visit www.epsonstore.com (U.S. sales) or www.epson.ca (Canadian sales).

Specifications

General

Type of display	Poly-silicon TFT active matrix
Size of LCD panels	0.74 inch (18 mm) wide
Lens	F=2.0 to 3.17
Resolution (native format)	1920 × 1080 pixels, 1080p
Brightness	Normal mode: White light output 1800 lumens (ISO 21118 standard) Color light output 1800 lumens
Dynamic contrast ratio	25000:1
Image size	30 to 300 inches
Projection distance	2.85 to 62.83 feet (0.87 to 19.15 m)
Zoom ratio	1 to 2.1
Aspect ratio	16:9
Fan noise level	22 to 28 dB

Lamp

Note: Lamp life will vary depending on mode selected, environmental conditions, and usage. Brightness decreases over time.

Turn off this product when not in use to prolong the life of the projector.

Type	UHE (Ultra High Efficiency), E-TORL
Power consumption	200 W
Lamp life	4000 hours
Part number	V13H010L49

Remote Control

Range	Approximately 30 feet (9 m)
Batteries	AA × 2

Dimensions

Height	5.4 inches (136 mm), not including adjustable feet
Width	17.7 inches (450 mm)
Depth	14.2 inches (360 mm); not including lens protrusion
Weight	16.1 lb (7.3 kg)

Electrical

Rated frequency	50/60 Hz AC
Power supply	100 to 120 VAC: 3.1 A 200 to 240 VAC: 1.3 A
Power consumption	100 to 120 VAC: Operating: 272 W Standby: 0.2 W 220 to 240 VAC: Operating: 261 W Standby: 0.3 W

Environmental

Temperature	Operating: 41 to 95 °F (5 to 35 °C) Storage: 14 to 140 °F (-10 to 60 °C)
Humidity	Operating: 20 to 80% RH, non-condensing Storage: 10 to 90% RH, non-condensing
Operating altitude	Up to 7500 feet (2286 meters); over 4921 feet (1500 meters), enable High Altitude mode in the Settings menu (see page 47)

Safety

United States	FCC Part 15B Class B (DoC) UL60950-1
Canada	ICES-003 Class B CSA C22.2 No. 60950-1



Pixelworks DNX™ ICs are used in this projector.

Compatible Video Formats

The projector supports analog video in NTSC, PAL, and SECAM formats, and it automatically adjusts to the incoming signal. It can receive these formats as composite video, S-video, or component video—which it accepts through the Video, S-Video, and Component ports, respectively.

The projector also supports digital video (SDTV, HDTV) and various monitor display formats. Digital video is accepted by the HDMI and Component video ports. The PC port accepts analog RGB computer monitor signals.

If necessary, you can select a different Aspect setting to optimize the image. The resolution at which the image displays for a given setting depends on the currently active picture source, as listed in the following tables.

Composite video or S-Video

Format	Refresh rate (Hz)	Resolution
NTSC	60	720 × 480
PAL	50	720 × 576
SECAM	50/60	720 × 576

Component video

Format/ Signal	Refresh rate (Hz)	Resolution
SDTV 480i 576i 480p 576p	60 50 60 50	720 × 480 720 × 576 720 × 480 720 × 576
HDTV 720p 1080i 1080p	50/60 50/60 50/60	1280 × 720 1920 × 1080 1920 × 1080

Analog RGB (computer display)

Signal	Refresh rate (Hz)	Resolution
VGA	60/72/75/85	640 × 480
SVGA	56/60/72/ 75/85	800 × 600
XGA	60/70/75/85	1024 × 768
SXGA	70/75/85 60/75/85 60/75/85	1152 × 864 1280 × 960 1280 × 1024

Signal	Refresh rate (Hz)	Resolution
WXGA	60	1280 × 768
	60	1360 × 768
	60/75/85	1280 × 800
MAC13"	67	640 × 480
MAC16"	75	832 × 624
MAC19"	59/75	1024 × 768
MAC21"	75	1152 × 870

HDMI

Signal	Refresh rate (Hz)	Resolution
VGA	60	640 × 480
SDTV		
480i	60	720 × 480
576i	50	720 × 576
480p	60	720 × 480
576p	50	720 × 576
HDTV		
720p	50/60	1280 × 720
1080i	50/60	1920 × 1080
1080p	24/30/50/60	1920 × 1080

ESC/VP21 Command Codes

You can use an AV controller with a 9-pin null modem serial cable to control the projector. You can download the complete *ESC/VP 21 Communication Manual* for home theater projectors from the Epson website at epson.com/support (U.S.) or epson.ca/support (Canada). Following are some of the available codes:

Item		Command	
Power ON/OFF	ON	PWR ON	
	OFF	PWR OFF	
A/V Mute ON/OFF	ON	MUTE ON	
	OFF	MUTE OFF	
A/V Mute selection	Black	MSEL 00	
	Blue	MSEL 01	
Source change	Terminal	Signal name	
	Component	Component video	SOURCE 10
		YCbCr	SOURCE 14
		YPbPr	SOURCE 15
		Auto	SOURCE 1F
	PC	HDB15	SOURCE 20
		RGB	SOURCE 21
	HDMI 1	HDMI 1	SOURCE 30
	Video	Video/S-Video	SOURCE 40
		Video (RCA)	SOURCE 41
		S-Video	SOURCE 42
	HDMI 2	HDMI 2	SOURCE A0
Color Mode	Theatre	CMODE 05	
	Dynamic	CMODE 06	
	Natural	CMODE 07	
	x.v.Color	CMODE 0B	
	Living Room	CMODE 0C	
Aspect ratio	Normal	ASPECT 00	
	Full	ASPECT 40	
	Zoom	ASPECT 50	
	Wide	ASPECT 70	

Notices

Important Safety Information

Follow these safety instructions when setting up and using the projector:

- Never look into the projector lens when the lamp is turned on; the bright light can damage your eyes. Never let children look into the lens when it is on.
- Never open any cover on the projector, except the lamp and filter covers. Dangerous electrical voltages inside the projector can severely injure you.
- Except as specifically explained in this *User's Guide*, do not attempt to service this product yourself. Refer all servicing to qualified service personnel.
- The projector and its accessories come packaged in plastic bags. Keep plastic bags away from small children to avoid any risk of suffocation.
- Don't place the projector on an unstable cart, stand, or table. Also, don't use the projector near water or sources of heat.
- Use the type of power source indicated on the projector. If you're not sure of the power available, consult your dealer or power company.
- Place the projector near a wall outlet where the plug can be easily unplugged.
- Don't insert the plug into an outlet with dust present, and insert the plug firmly into the outlet. Failure to do so could result in sparks or fire.
- Don't overload wall outlets, extension cords, or integral convenience receptacles. This can cause fire or electric shock.
- Don't block the slots and openings in the projector case. They provide ventilation and prevent the projector from overheating. Don't operate the projector on a sofa, rug, or other soft surface, or in a closed-in cabinet unless proper ventilation is provided.
- Never push objects through the cabinet slots or spill liquid into the projector.
- Unplug the projector from the wall outlet and refer servicing to qualified service personnel under the following conditions: when the power cord or plug is damaged or frayed; if liquid has been spilled into the projector, or if it has been exposed to rain or water; if it doesn't operate normally when you follow the operating instructions, or if it exhibits a distinct change in performance, indicating a need for service; if it has been dropped or the housing has been damaged.
- Don't place the projector where the cord can be walked on. This may result in fraying or damage to the plug.
- Unplug the projector from the wall outlet before cleaning. Use a damp cloth for cleaning. Do not use liquid or aerosol cleaners.

- (Hg) The lamp(s) in this product contain mercury. Please consult your state and local regulations regarding disposal or recycling. Do not put in the trash.
- Allow the lamp to cool for one hour before replacing it.
- Unplug the projector during lightning storms or when not in use for extended periods.
- Don't place the projector or remote control on top of heat-producing equipment.
- If you use the projector in a country other than where you purchased it, use the correct power cord for that country.
- Don't stand on the projector or place heavy objects on it.
- Don't use the projector outside of the required temperature range of 41 to 95 °F (5 to 35 °C). Doing so may cause an unstable display and could lead to projector damage.
- Don't store the projector outside of the required temperature range of 14 to 140 °F (-10 to 60 °C) or in direct sunlight for long periods of time. Doing so may cause damage to the case.

WARNING: The cords included with this product contain chemicals, including lead, known to the State of California to cause birth defects or other reproductive harm. *Wash hands after handling.* (This notice is provided in accordance with Proposition 65 in Cal. Health & Safety Code § 25249.5 and following.)

FCC Compliance Statement

For United States Users

This equipment has been tested and found to comply with the limits for a Class B digital device, pursuant to Part 15 of the FCC Rules. These limits are designed to provide reasonable protection against harmful interference in a residential installation. This equipment generates, uses, and can radiate radio frequency energy and, if not installed and used in accordance with the instructions, may cause harmful interference to radio or television reception. However, there is no guarantee that interference will not occur in a particular installation. If this equipment does cause interference to radio and television reception, which can be determined by turning the equipment off and on, the user is encouraged to try to correct the interference by one or more of the following measures:

- Reorient or relocate the receiving antenna.
- Increase the separation between the equipment and receiver.
- Connect the equipment into an outlet on a circuit different from that to which the receiver is connected.
- Consult the dealer or an experienced radio/TV technician for help.

WARNING

The connection of a non-shielded equipment interface cable to this equipment will invalidate the FCC Certification of this device and may cause interference levels which exceed the limits established by the FCC for this equipment. It is the responsibility of the user to obtain and use a shielded equipment interface cable with this device. If this equipment has more than one interface connector, do not leave cables connected to unused interfaces. Changes or modifications not expressly approved by the manufacturer could void the user's authority to operate the equipment.

For Canadian Users

This Class B digital apparatus meets all requirements of the Canadian Interference-Causing Equipment Regulations.

Cet appareil numérique de la classe B respecte toutes les exigences du Règlement sur le matériel brouilleur du Canada.

Declaration of Conformity

According to 47CFR, Part 2 and 15 for Class B Personal Computers and Peripherals; and/or CPU Boards and Power Supplies used with Class B Personal Computers:

We: Epson America, Inc.
Located at: 3840 Kilroy Airport Way
MS 3-13
Long Beach, CA 90806-2469
Telephone: (562) 290-5254

Declare under sole responsibility that the product identified herein, complies with 47CFR Part 2 and 15 of the FCC rules as a Class B digital device. Each product marketed is identical to the representative unit tested and found to be compliant with the standards. Records maintained continue to reflect the equipment being produced can be expected to be within the variation accepted, due to quantity production and testing on a statistical basis as required by 47CFR §2.909. Operation is subject to the following two conditions: (1) this device may not cause harmful interference, and (2) this device must accept any interference received, including interference that may cause undesired operation.

Trade Name: Epson
Type of Product: Projector
Model: H416A
Marketing Name: PowerLite Home Cinema 8345

Epson America, Inc. Limited Warranty

Two-Year Projector Limited Warranty and 90-Day Lamp Limited Warranty

What Is Covered: Epson America, Inc. ('Epson') warrants to the original retail purchaser of the Epson projector product enclosed with this limited warranty statement that the product, if purchased new and operated in the United States, Canada, or Puerto Rico will be free from defects in workmanship and materials for a period of two (2) years from the date of original purchase. This limited warranty applies only to the projector and not to the projector lamp, which carries a limited warranty period of ninety (90) days from the date of original purchase. For warranty service, you must provide proof of the date of original purchase.

What Epson Will Do To Correct Problems: If your product requires service during the limited warranty period, please call Epson at the number on the bottom of this statement and be prepared to provide the model, serial number, and date of original purchase. Epson will, at its option, repair or replace the defective unit, without charge for parts or labor. When warranty service involves the exchange of the product or of a part, the item replaced becomes Epson property. The exchanged product or part may be new or refurbished to the Epson standard of quality, and at Epson's option, the replacement may be another model of like kind and quality. Epson's liability for replacement of the covered product will not exceed the original retail selling price of the covered product. Exchange or replacement products or

parts assume the remaining warranty period of the product covered by this limited warranty. If Epson replaces the lamp as part of the warranty service, the replacement lamp carries the limited 90-day warranty stated above.

What This Warranty Does Not Cover: This warranty covers only normal use in the United States, Canada or Puerto Rico. Twenty-four hours per day or other excessive continual use is not considered normal use. This warranty does not cover consumables such as filters. This warranty is not transferable. Epson is not responsible for warranty service should the Epson label or logo or the rating label or serial number be removed. Epson is not responsible for warranty service should the product fail to be properly maintained or fail to function properly as a result of misuse, abuse, improper installation, neglect, improper shipping, damage caused by disasters such as fire, flood, and lightning, improper electrical current, software problems, interaction with non-Epson products, or service other than by Epson or an Epson Authorized Servicer. Postage, insurance, or shipping costs incurred in presenting your Epson product for carry-in warranty service are your responsibility. Epson will pay for all freight charges if you choose to send your unit to Epson for repair. If a claimed defect cannot be identified or reproduced in service, you will be held responsible for costs incurred.

THE WARRANTY AND REMEDY PROVIDED ABOVE ARE EXCLUSIVE AND IN LIEU OF ALL OTHER EXPRESS OR IMPLIED WARRANTIES INCLUDING, BUT NOT LIMITED TO, THE IMPLIED WARRANTIES OF MERCHANTABILITY OR FITNESS FOR A PARTICULAR PURPOSE. SOME LAWS DO NOT ALLOW THE EXCLUSION OF IMPLIED WARRANTIES. IF THESE LAWS APPLY, THEN ALL EXPRESS AND IMPLIED WARRANTIES ARE LIMITED TO THE WARRANTY PERIOD IDENTIFIED ABOVE. UNLESS STATED HEREIN, ANY STATEMENTS OR REPRESENTATIONS MADE BY ANY OTHER PERSON OR FIRM ARE VOID. IN THE EVENT THE REMEDIES ABOVE FAIL, EPSON'S ENTIRE LIABILITY SHALL BE LIMITED TO A REFUND OF THE PRICE PAID FOR THE EPSON PRODUCT COVERED BY THIS LIMITED WARRANTY. EXCEPT AS PROVIDED IN THIS WRITTEN WARRANTY, NEITHER EPSON AMERICA, INC. NOR ITS AFFILIATES SHALL BE LIABLE FOR ANY LOSS, INCONVENIENCE, OR DAMAGE, INCLUDING DIRECT, SPECIAL, INCIDENTAL, OR CONSEQUENTIAL DAMAGES, RESULTING FROM THE USE OR INABILITY TO USE THE EPSON PRODUCT, WHETHER RESULTING FROM BREACH OF WARRANTY OR ANY OTHER LEGAL THEORY.

In Canada, warranties include both warranties and conditions.

Some jurisdictions do not allow limitations on how long an implied warranty lasts and some jurisdictions do not allow the exclusion or limitation of incidental or consequential damages, so the above limitations and exclusions may not apply to you. This warranty gives you specific legal rights, and you may also have other rights, which vary from jurisdiction to jurisdiction.

To find the Epson Authorized Reseller nearest you, please visit our website at: www.epson.com.

To find the Epson Customer Care Center nearest you, please visit www.epson.com/support.

To contact the Epson ConnectionSM, please call (800) 637-7661 + PIN or (562) 276-4394 in the U.S. and (905) 709-3839 in Canada or write to Epson America, Inc., P.O. Box 93012, Long Beach, CA 90809-3012.

Index

Numerics

2-2 Pull-down, 38

A

Abs. Color Temp. setting, 39

Accessories, 10, 62

Air filter

cleaning and replacing, 49 to 50

ordering, 10

Anti-theft device, 7, 10

Aspect button, 9, 27, 58

Aspect ratio, selecting, 27, 44

Auto Iris setting, 36

Auto Setup, 41

B

Batteries, remote control, 21

Blank button, 23

Blurry picture, 60

Brightness

setting, 36

specification, 63

Buttons

projector, 8

remote control, 9

C

Cables, connecting, 18 to 20

Child Lock, 32, 47

Cleaning

air filter, 49 to 50

lens, 48

projector case, 49

Codes, AV controller, 67

Color

adjusting, 29 to 31, 39 to 40

isolating, 39

problems, 60

Color Mode, 9, 28, 60

Color Saturation setting, 39

Color temperature setting, 39

Component setting, 46

Component video connection, 18

Computer

adjusting image, 41

displaying image, 59

Contrast

button, 9

ratio, 63

setting, 36

Control Panel Lock, 47

Control panel lock, 32

Control panel, projector, 8

D

Declaration of Conformity, 71

Direct Power On, 46

Display Background setting, 45

Documentation, 11

E

Electrical requirements, 64

Epson

accessories, 10, 62

Home Service, 10

PrivateLine Support, 11, 62

technical support, 11, 62

warranty, 10, 71 to 72

EPSON Super White setting, 36

ESC/VP21 command codes, 67

F

FCC Compliance Statement, 70
Filter, *see* Air filter
Flickering, 38, 60
Focus ring, 26

G

Gain, color, 40
Gamma, 29 to 30, 40
Gamma button, 9

H

HDMI, 18, 19, 36 to 37
Help, 62
High Altitude Mode, 47
Home Service, 10

I

Illumination of buttons
 projector, 46, 56 to 57
 remote control, 21
Illumination setting, 46, 57
Image
 adjusting, 29 to 31, 35 to 41
 changing aspect ratio, 27
 inverting, 16, 45
 positioning, 24 to 25, 44
 resizing, 27, 44
 selecting source, 23
 size, 14 to 15
Image menu, 43
Image problems, 58 to 61
Image Size Calculator, 15
Info menu, 54
Installing projector, 16
Interference, signal, 60

K

Kensington anti-theft device, 7, 10

L

Lamp
 checking usage timer, 54
 life, 63
 ordering, 10, 51
 replacing, 51 to 53
 resetting usage timer, 54
 safety instructions, 68 to 69
 specifications, 63
Language setting, 35
Lens shift dials, 13, 24
Lens, cleaning, 48
Lights, projector, 46, 56 to 57
Line menu, 9
Lock
 Child Lock, 32, 47
 control panel lock, 32
 Kensington, 7, 10
 projector buttons, 32

M

Memory button, 9, 42
Memory settings
 creating, 42
 using, 42
Menu button, 9, 33
Menus
 available settings, 35 to 47
 customizing display, 35
 line menu, 9
 using, 33 to 35
Message setting, 45
Motion Detection, 38
Mounting projector, 16
Moving projector, 55

N

No image, 58 to 59
Noise Reduction, 38

O

Offset, color, 40
Overscan, 44

P

Pattern button, 9, 24, 39
Picture problems, 58 to 61
Pixelworks, 64
Positioning image, 24 to 25, 44
Positioning projector, 12 to 15
Power Consumption setting, 37
PrivateLine Support, 11, 62
Problems

- indicator lights, 56 to 57
- picture, 58 to 61
- remote control, 61

Progressive mode setting, 38
Projection distance, 14 to 15, 63
Projector

- checking status, 54
- cleaning, 49
- control panel, 8
- dimensions, 17, 64
- installing, 16
- lights, 46, 56 to 57
- locking buttons, 32
- menus, 35 to 47
- parts, 7 to 8
- positioning, 12 to 15
- resetting menu options, 43
- security lock, 7, 10
- storing, 55
- transporting, 55
- turning on and off, 21 to 22, 58

R

Registration, 10
Remote control

- batteries, 21
- buttons, 9
- lighting up buttons, 21
- problems, 61

Replacing lamp, 51 to 53
Resetting

- lamp usage timer, 44, 54
- projector settings, 43

Resolution

- compatible formats, 65 to 66
- projector, 54, 63

RGB settings, 40
RGBCMY setting, 29 to 31, 40

S

Safety approvals, 64
Safety instructions, 68 to 69
Setup level, 36
Sharpness, 37
Signal menu, 36
Skin Tone setting, 39
Sleep mode, 46
Source buttons, 8, 9
Source, selecting image, 23
Specifications

- compatible video formats, 65 to 66
- dimensions, 64
- electrical, 64
- environmental, 64
- general, 63
- lamp, 63
- remote control, 63

Startup screen, selecting, 45
Static, 60
Storing projector, 55
Support, 11, 62
S-Video connection, 18
Sync (Synchronization) setting, 41

T

Technical support, 11, 62
Test pattern, 24, 39
Tint, 39
Tracking, 41
Transporting projector, 55
Trigger out port, 20

Trigger out setting, 46
Turning on and off projector, 21 to 22, 58

V

Video Signal setting, 46
Video, compatible formats, 65 to 66
VP21 codes, 67

W

Warranty, 10, 71 to 72
Where to Get Help, 62
Wide setting, 27

X

x.v.Color setting, 28

Z

Zoom Caption Pos. setting, 27, 45
Zoom ring, 26
Zoom setting, 27
Zoom Size setting, 45