

Dive computer watch

CYBER AQUALAND™ Nx

ManualsLib.com

 **CITIZEN**

CITIZEN IS A REGISTERED TRADEMARK OF CITIZEN WATCH CO., JAPAN.

ManualsLib.com

ManualsLib.com

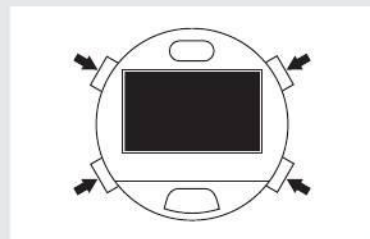
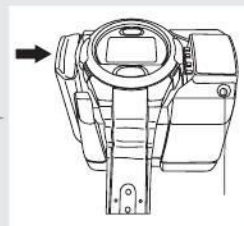
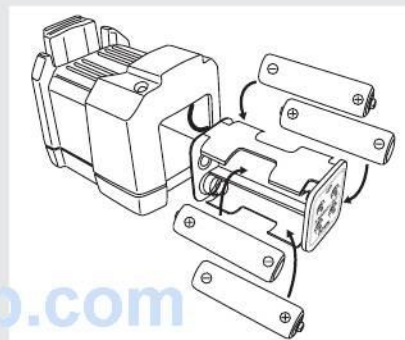



ManualsLib.com



ManualsLib.com





ManualsLib.com



ManualsLib.com





ManualsLib.com



ManualsLib.com



ManualsLib.com

ManualsLib.com

ManualsLib.com

ManualsLib.com

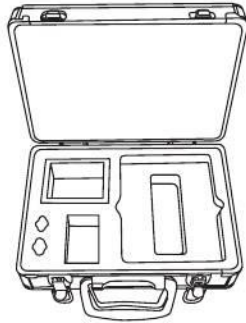

ManualsLib.com

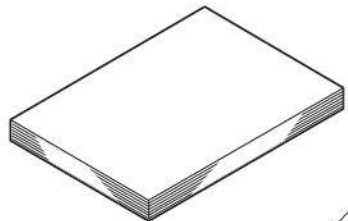
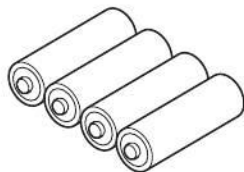
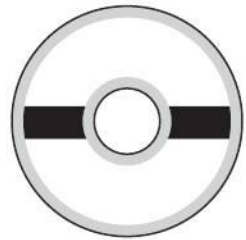



ManualsLib.com



2



ManualsLib.com





ManualsLib.com



ManualsLib.com

ManualsLib.com





ManualsLib.com

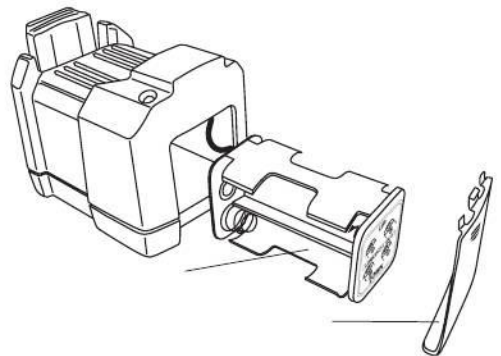
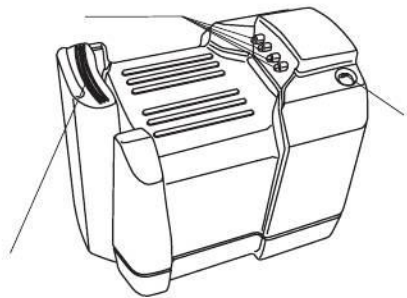



ManualsLib.com

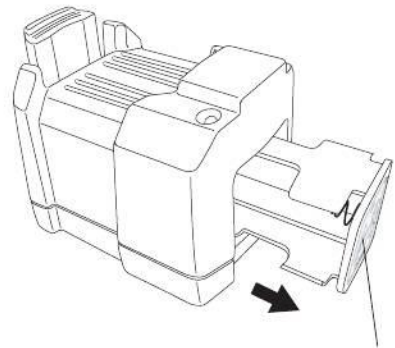
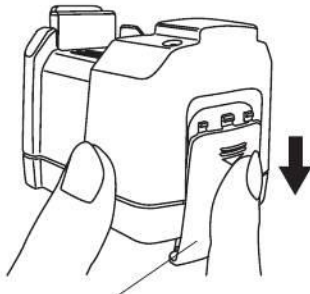

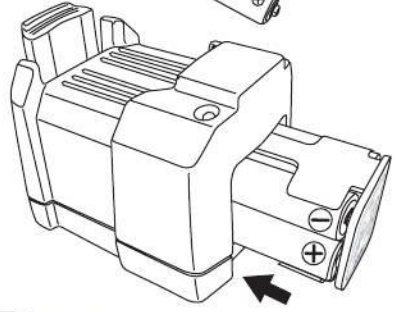
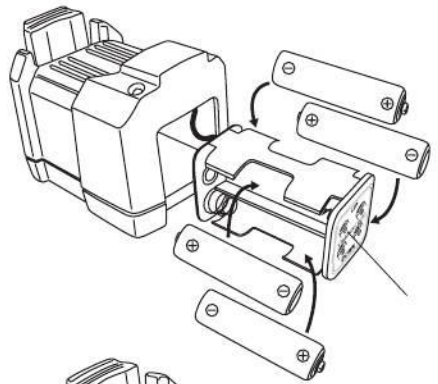

ManualsLib.com



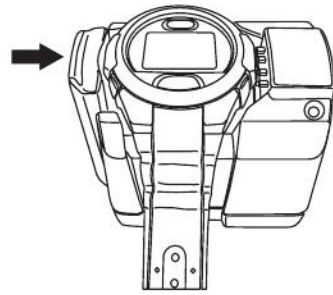
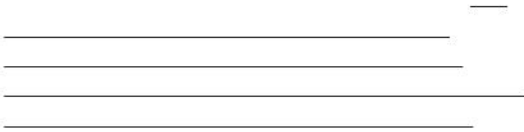

ManualsLib.com





ManualsLib.com

TRV

DST

ALM

CHR

TMR

BATT FILE

DV-FL

SCUBA LOG

SKIN LOG



SURF
ManualsLib.com

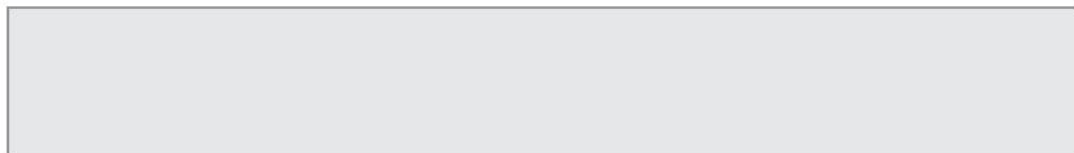

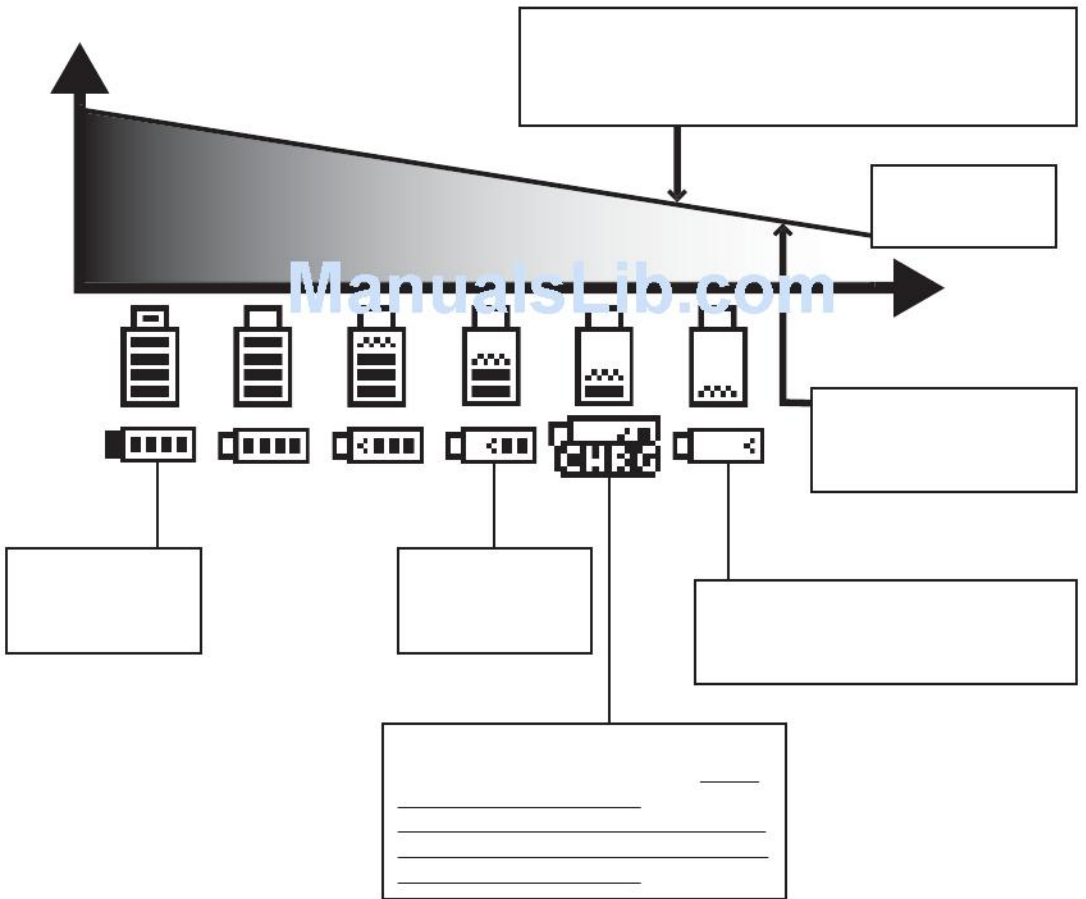

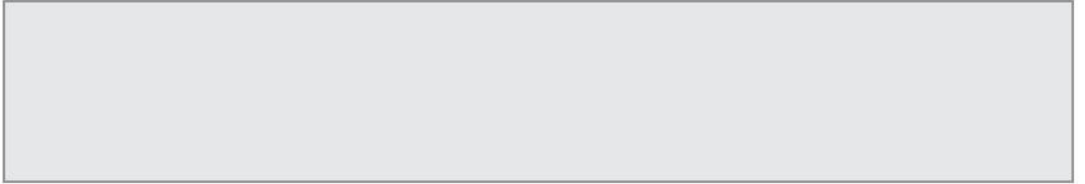

ManualsLib.com

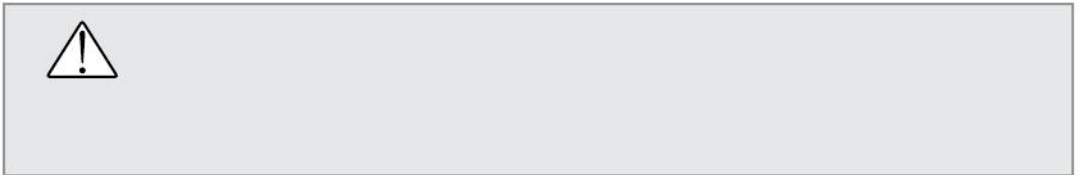
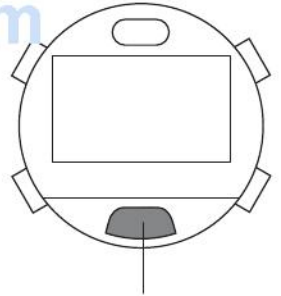

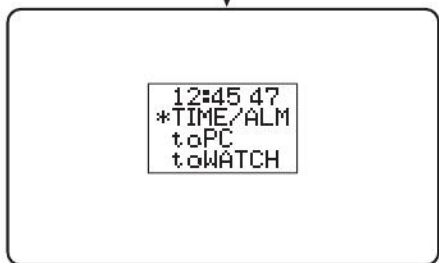
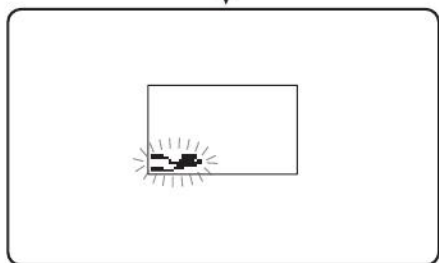
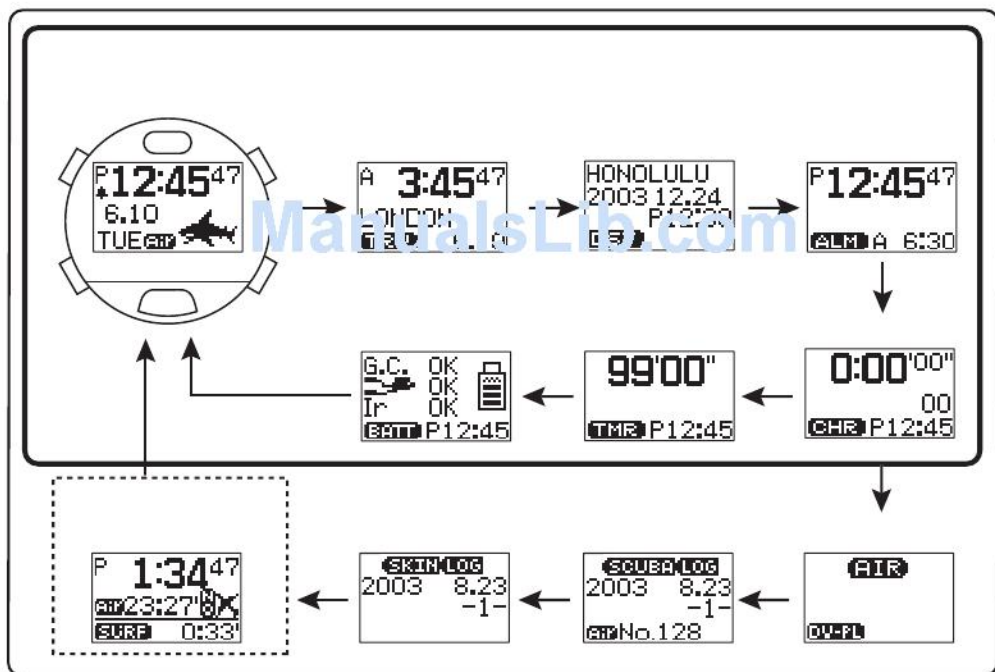

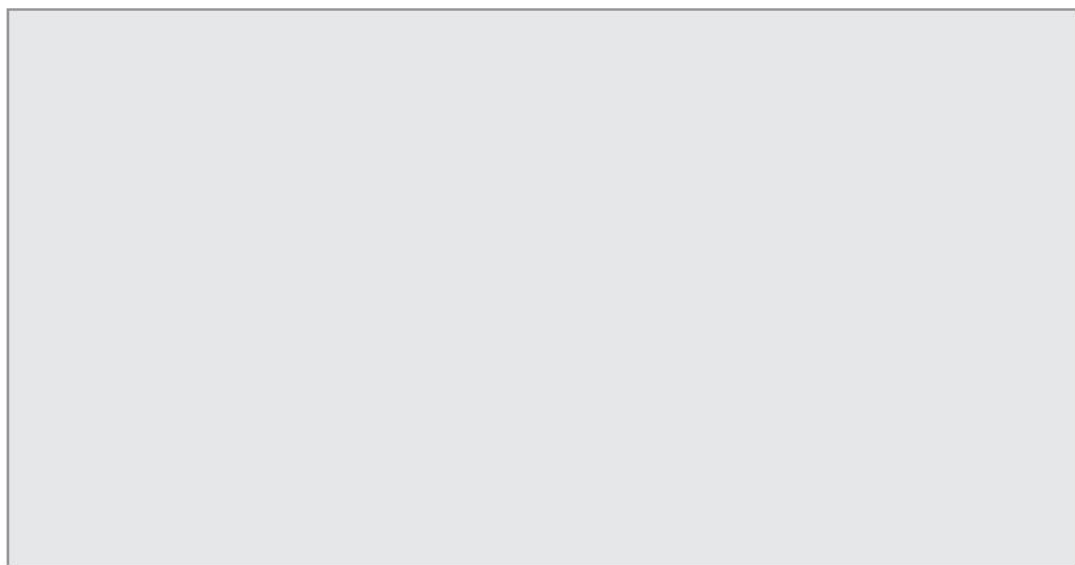

ManualsLib.com

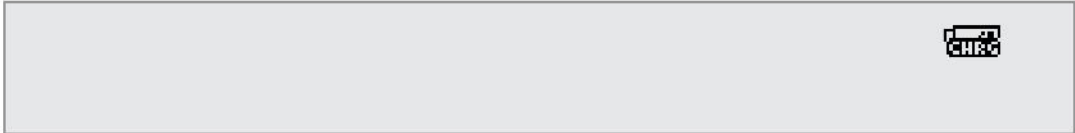
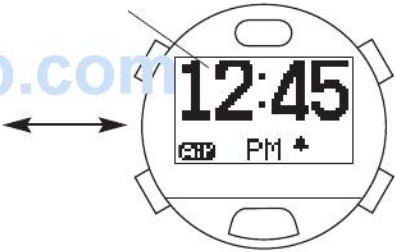
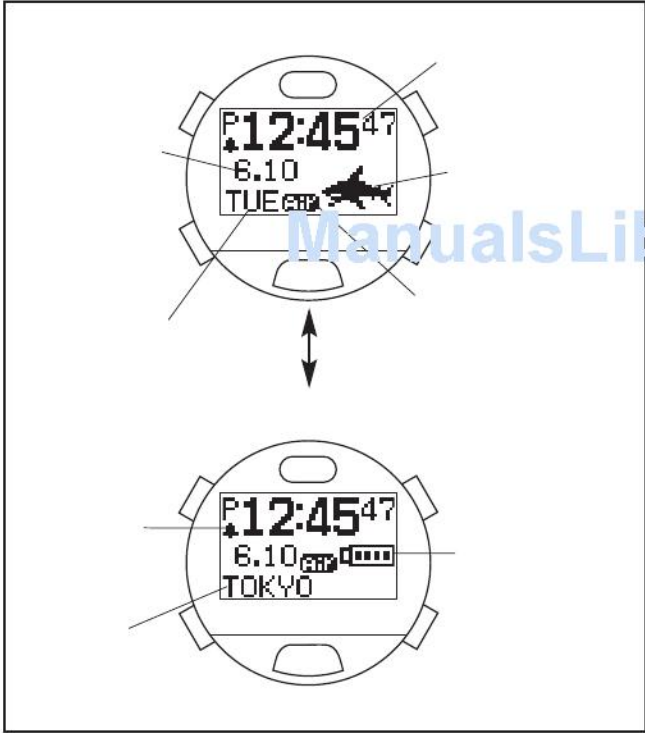

P 12:45⁴⁷
ST OFF
TOKYO

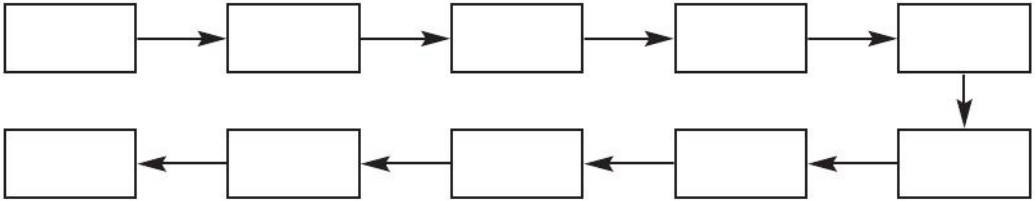

ManualsLib.com

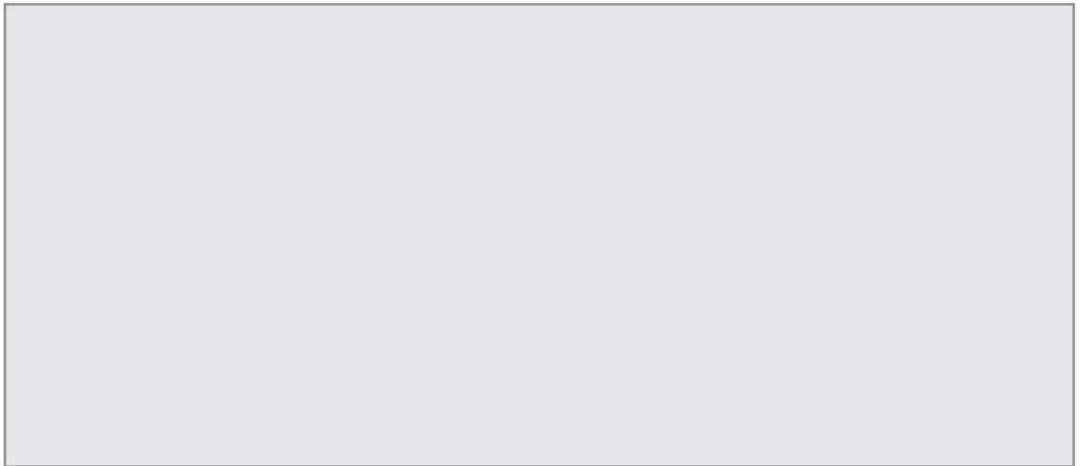



ManualsLib.com

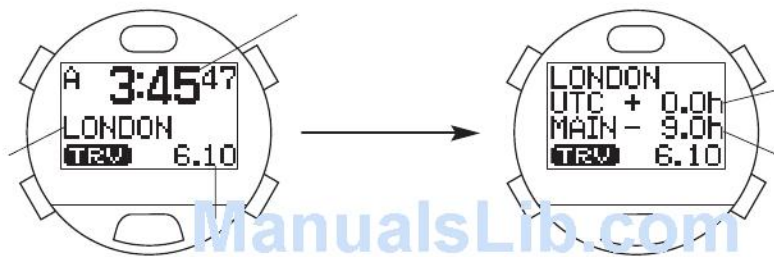

LONDON
ST OFF
UTC + 0.0h
TRV 6.10

ManualsLib.com

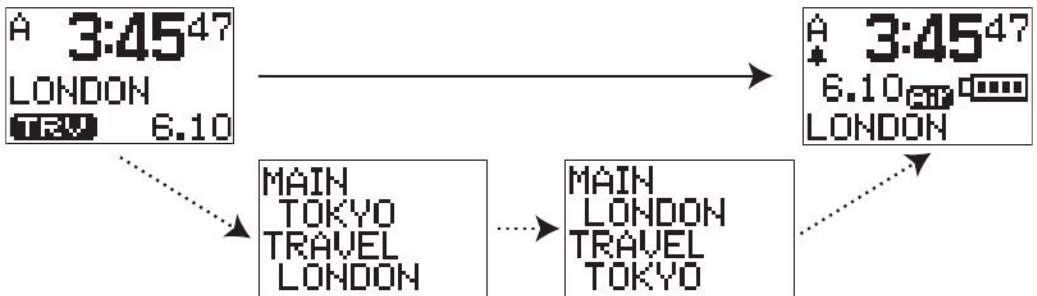



ManualsLib.com

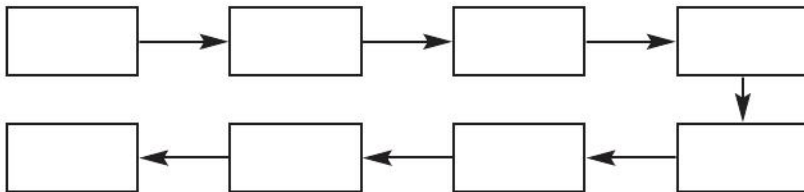

ManualsLib.com

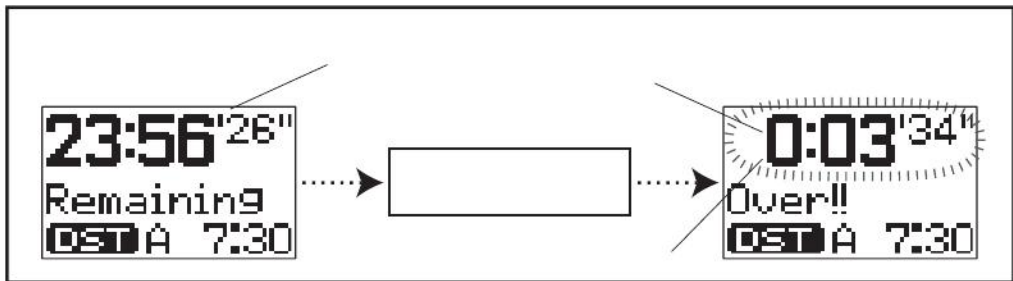

HONOLULU
2003 12.24
P12:30
DST

TOKYO
2001 12.25
A 7:30
DST

ManualsLib.com

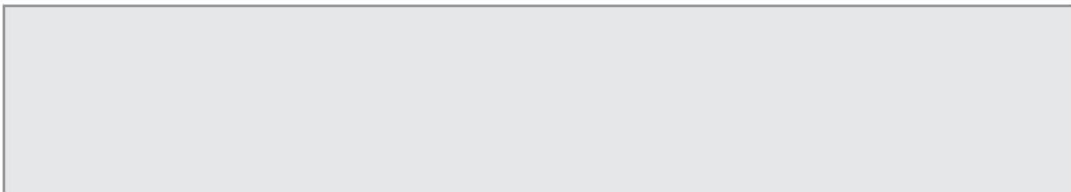

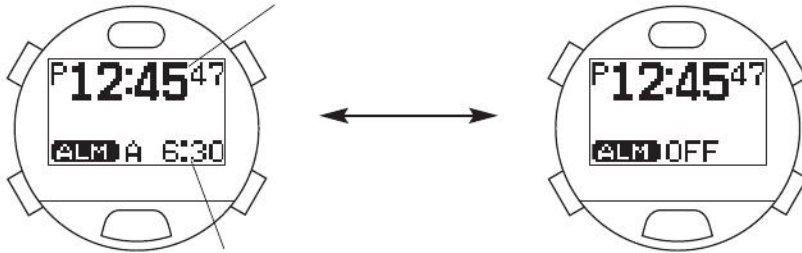

[ManualsLib.com](https://www.ManualsLib.com)



ManualsLib.com



ManualsLib.com

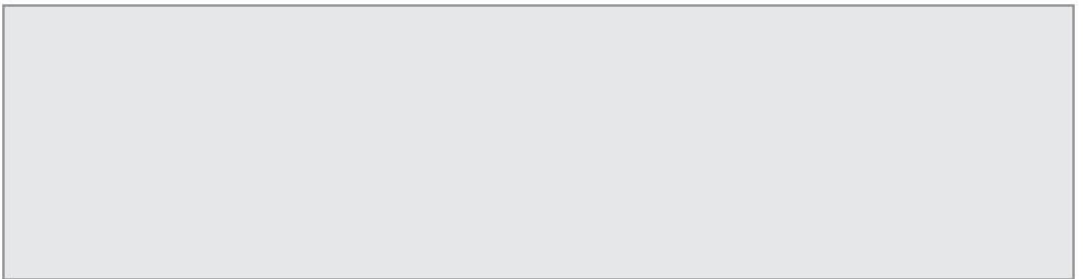
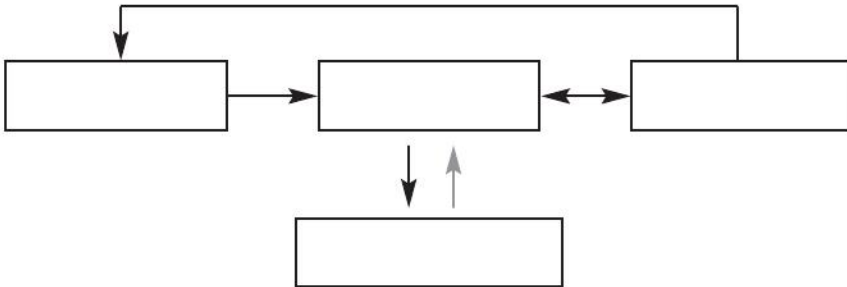



ManualsLib.com

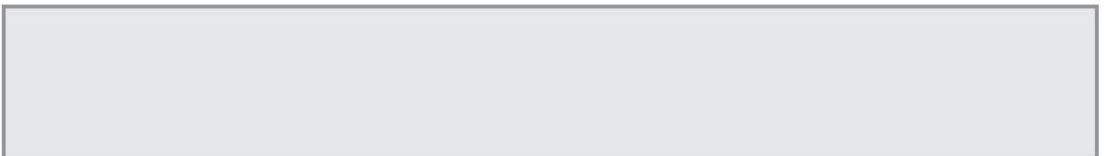

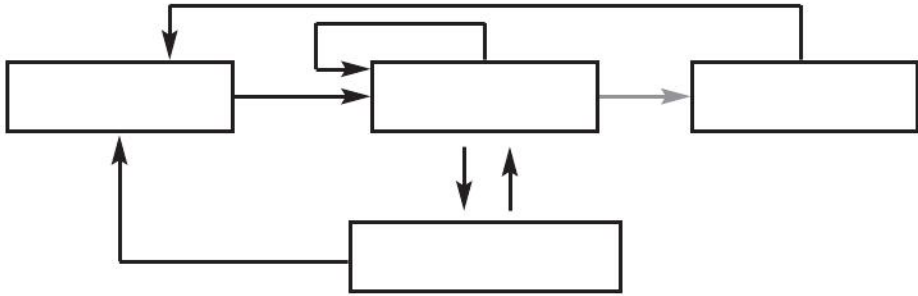

ManualsLib.com

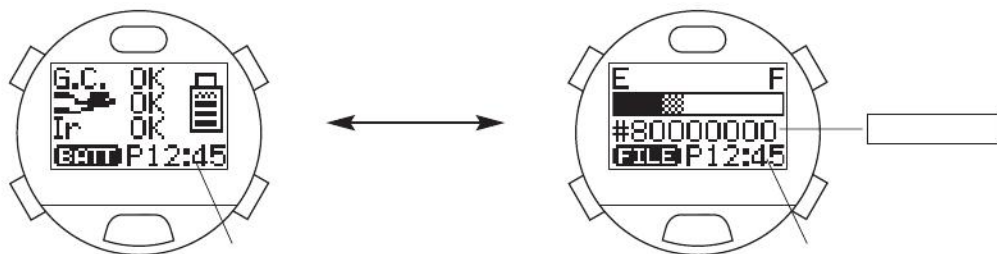

ManualsLib.com



CHRG



CHRG

ManualsLib.com

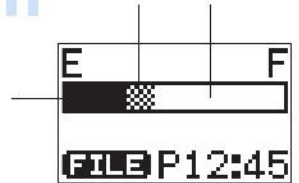



ManualsLib.com

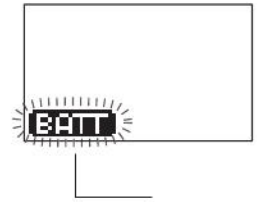

ManualsLib.com

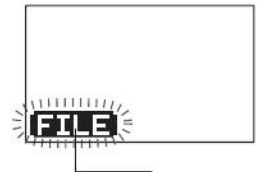

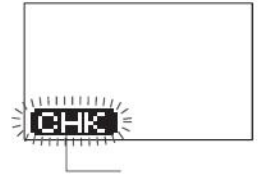
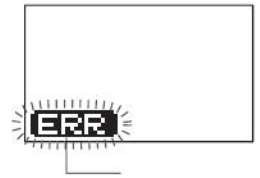

ManualsLib.com





ManualsLib.com

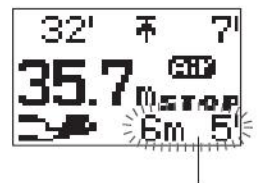
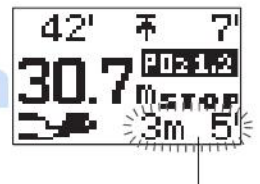



ManualsLib.com





ManualsLib.com

ManualsLib.com

ManualsLib.com

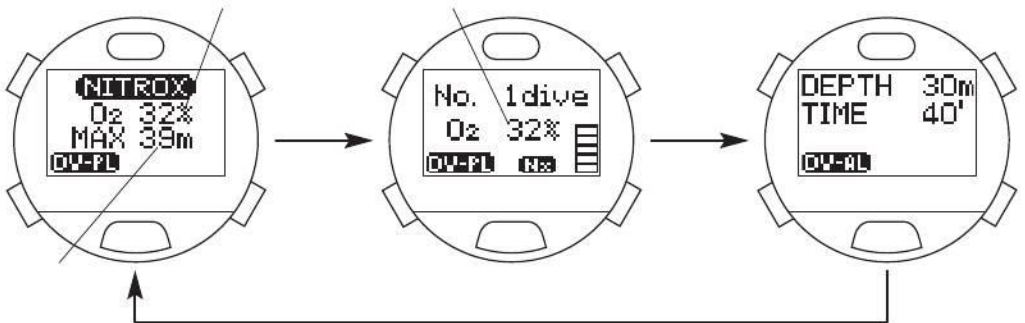
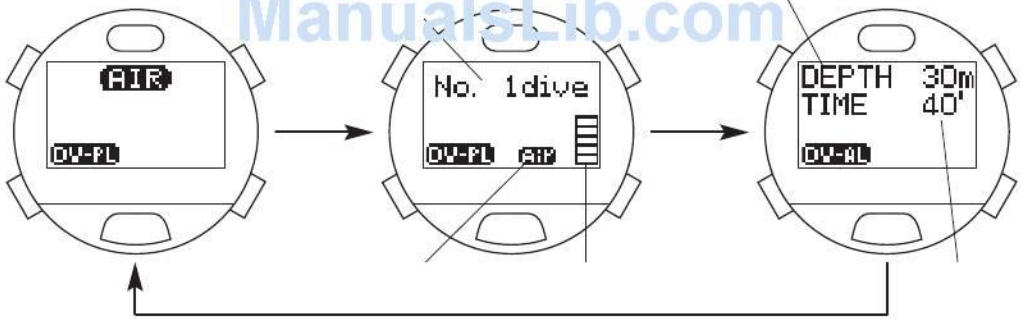

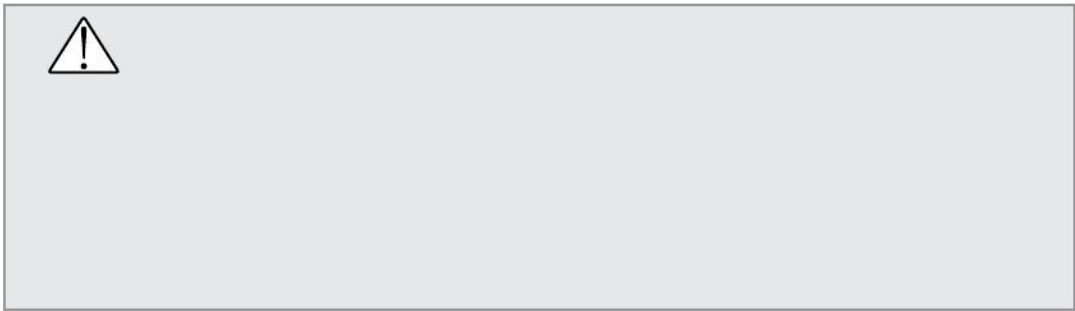
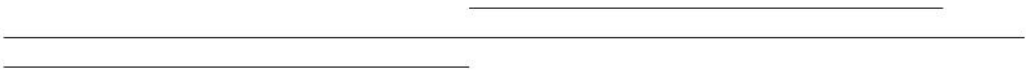
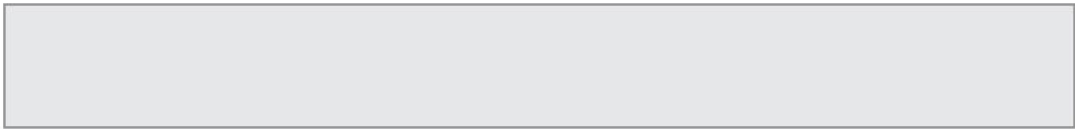

AIR

Nx

AIR

AIR

AIR

Nx

AIR
DU-PL



NITROX
O₂ 32%
MAX 39m
DU-PL



NITROX
O₂ 32%
MAX 39m
DU-PL



ManualsLib.com

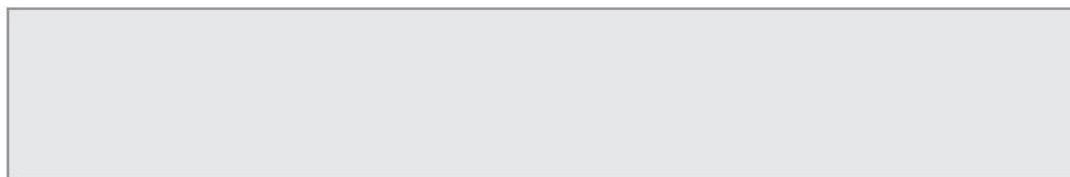

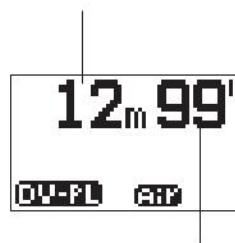

ManualsLib.com

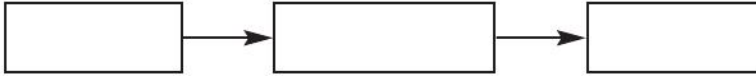

ManualsLib.com

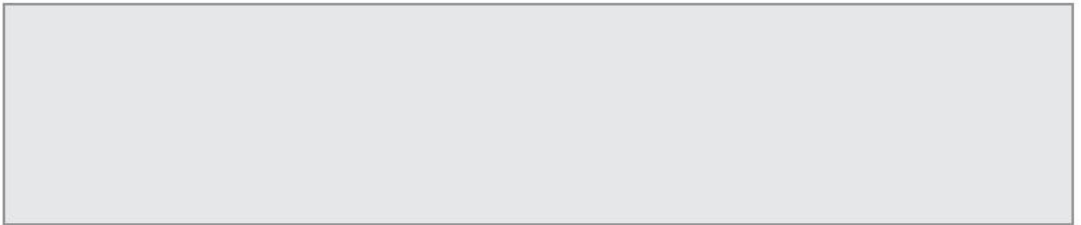

ManualsLib.com

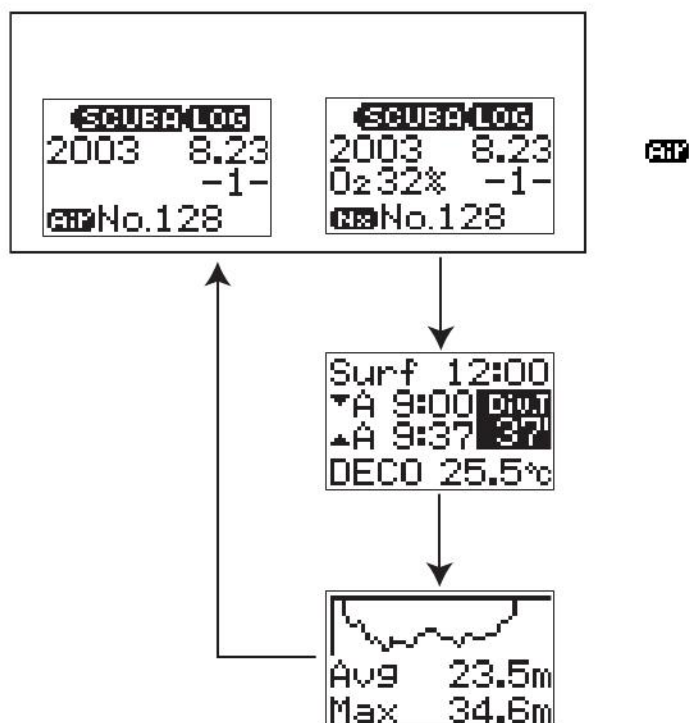

ManualsLib.com

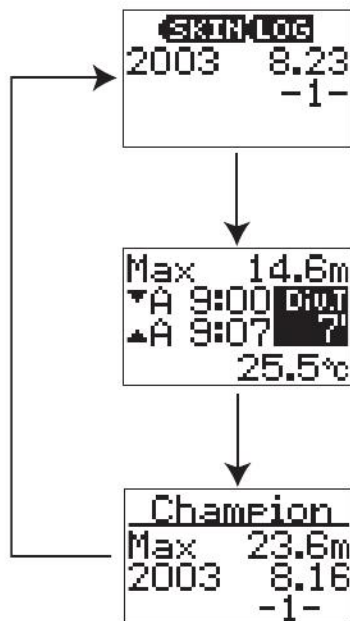



ManualsLib.com

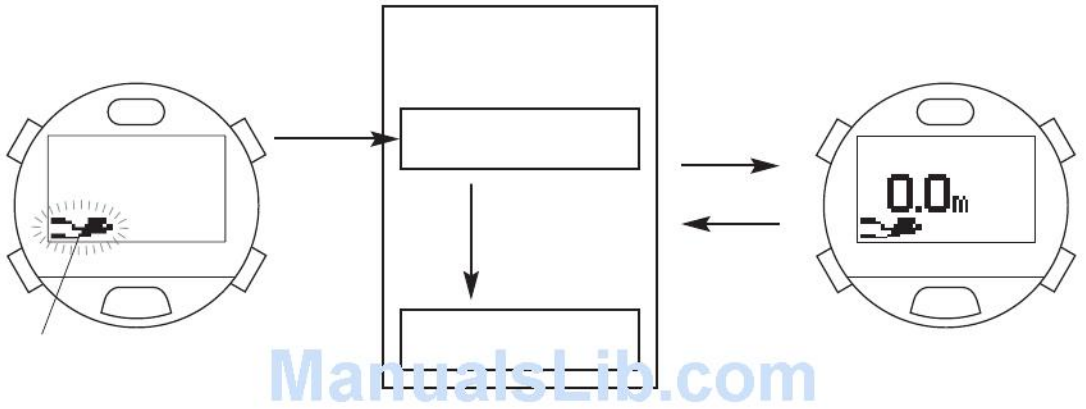

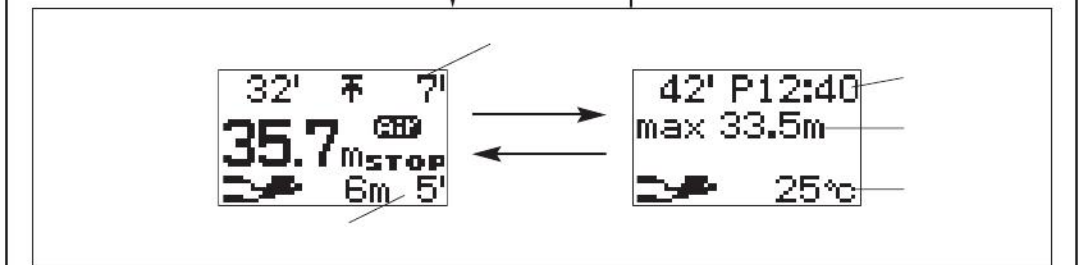
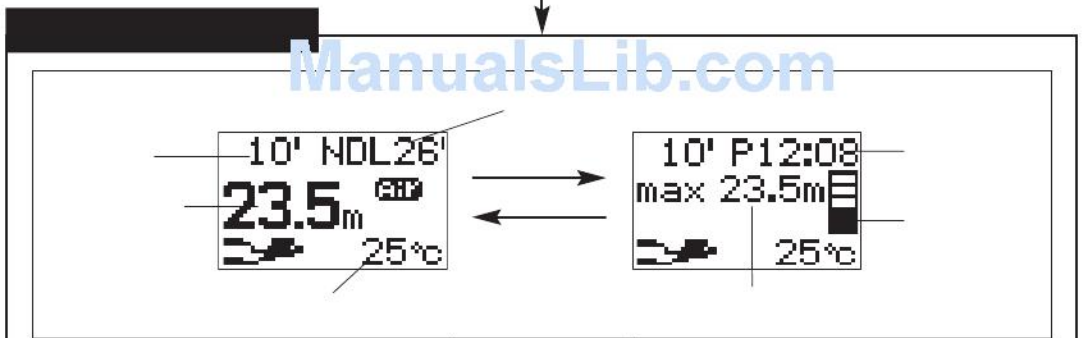
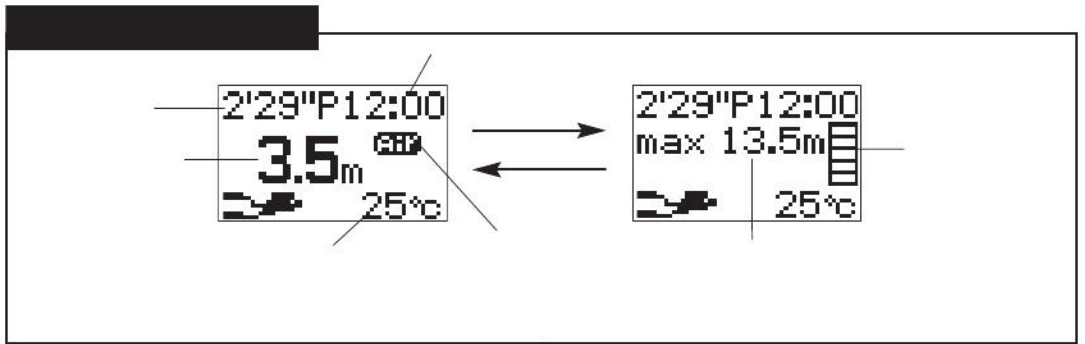

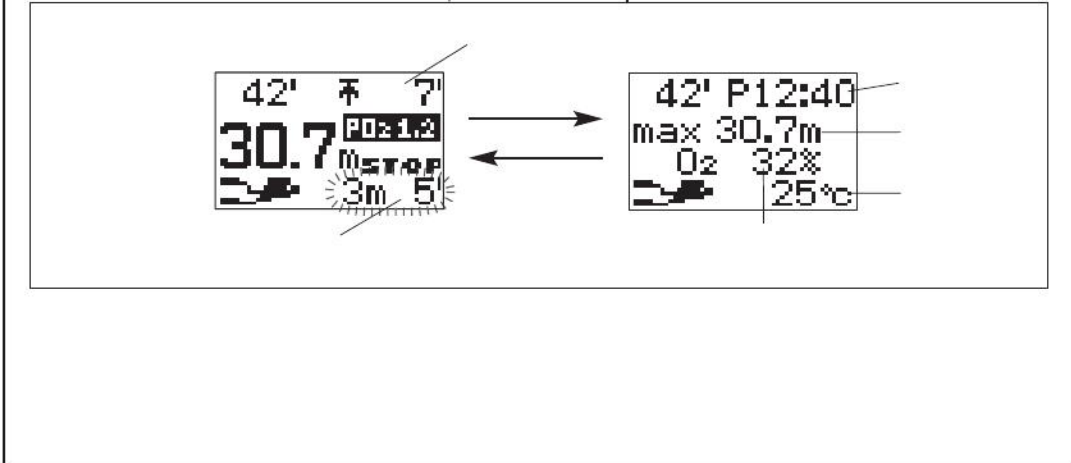
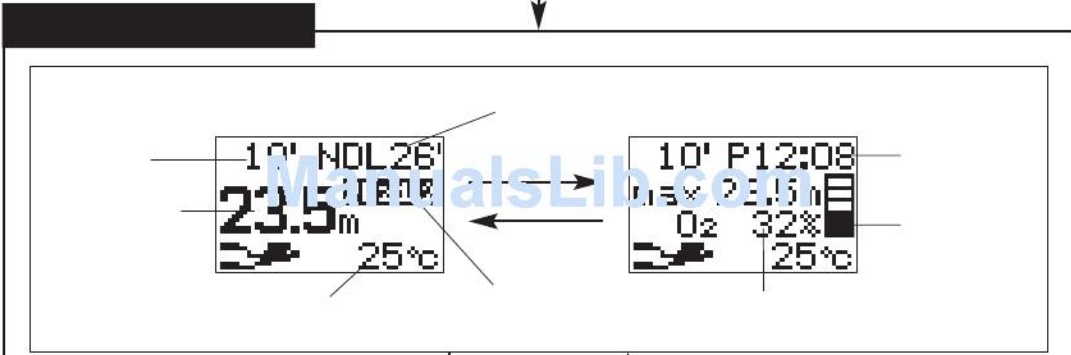
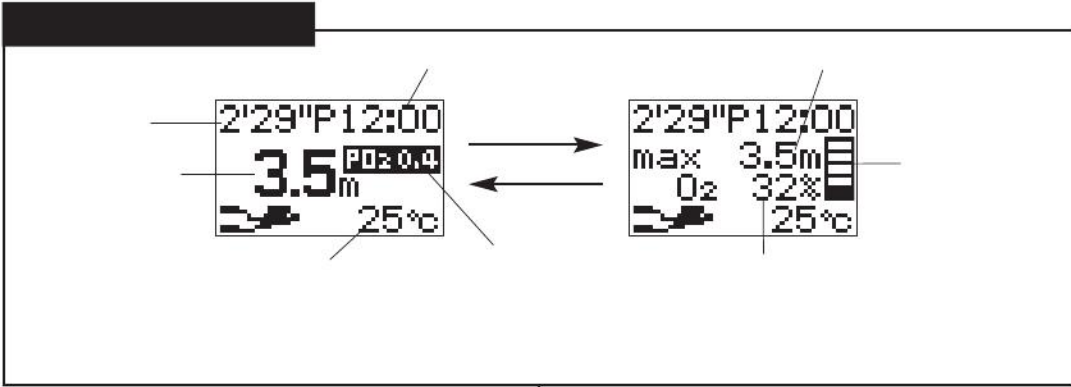



ManualsLib.com



ManualsLib.com

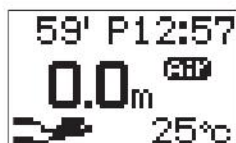



SURF

CHRG
CHRG

ManualsLib.com

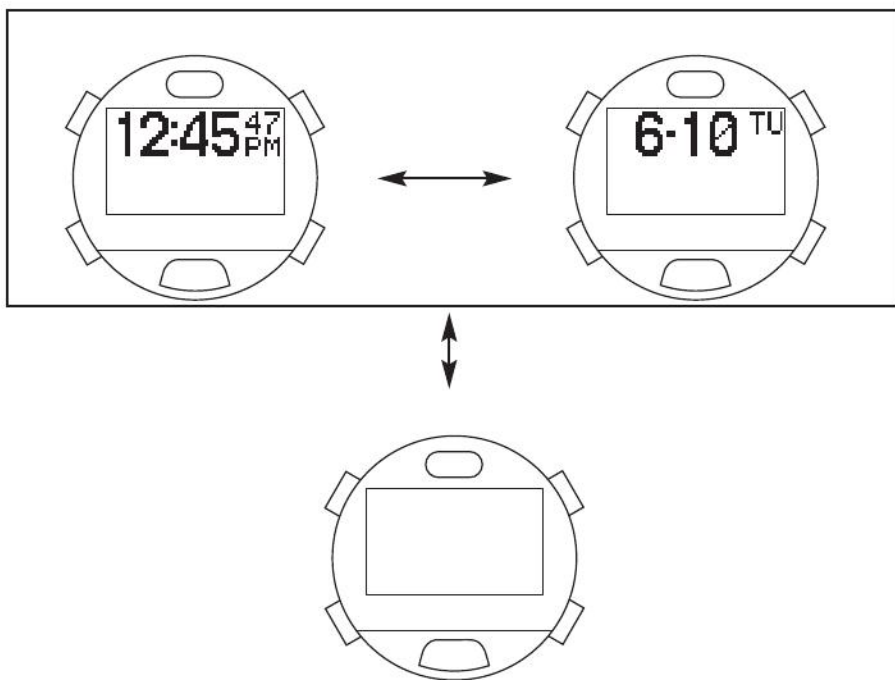

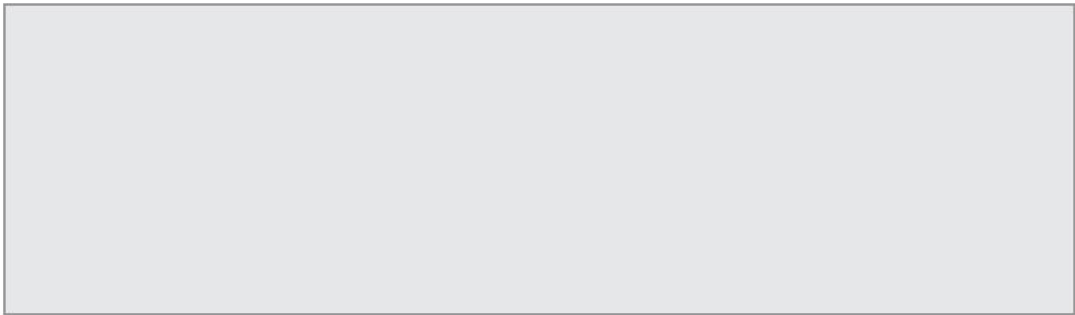

12:45⁴⁷ PM

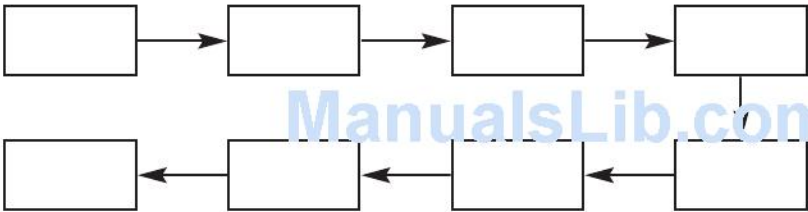

ManualsLib.com





ManualsLib.com

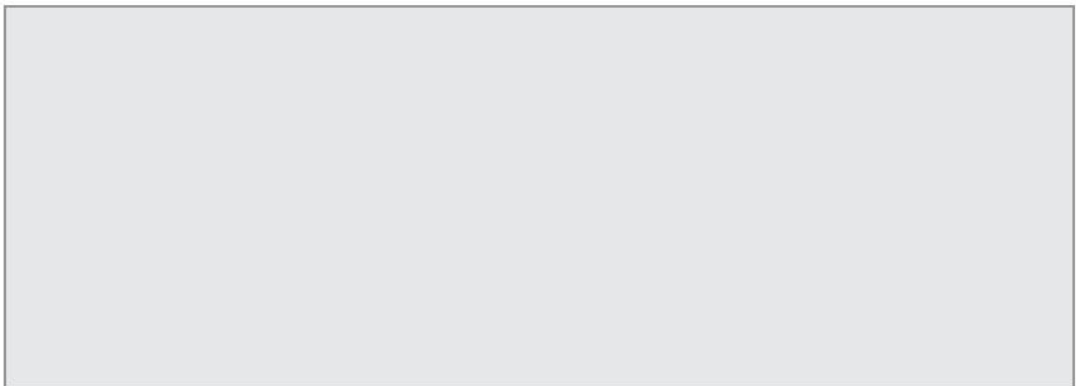
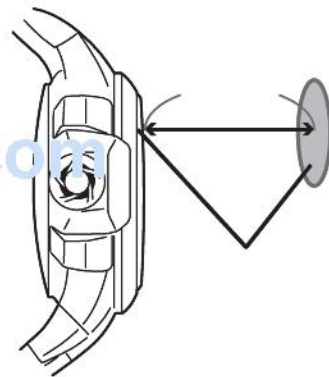

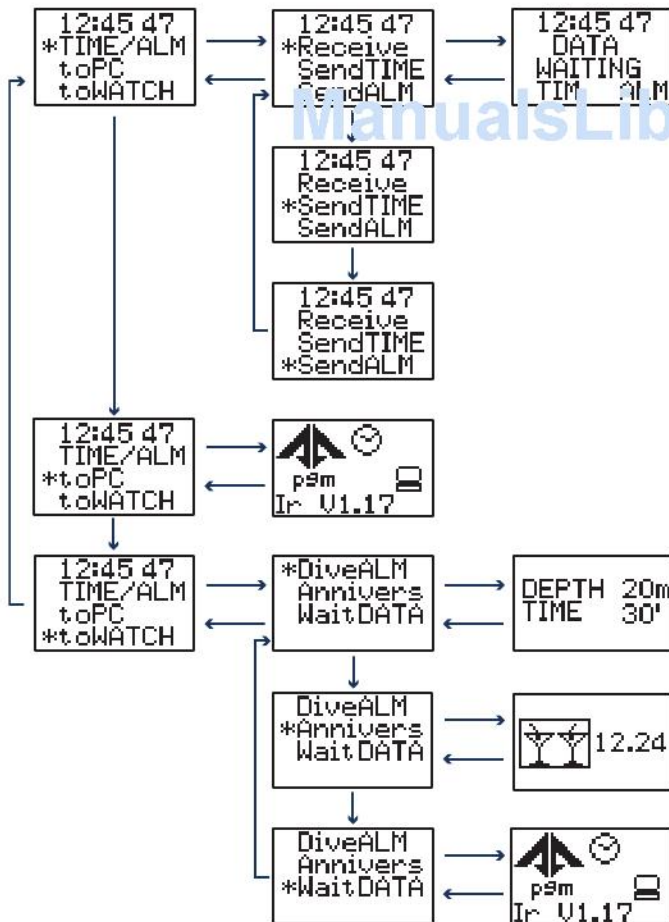
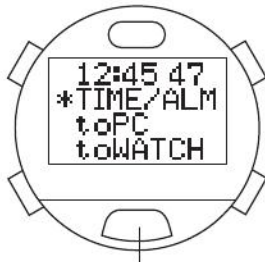



ManualsLib.com





ManualsLib.com

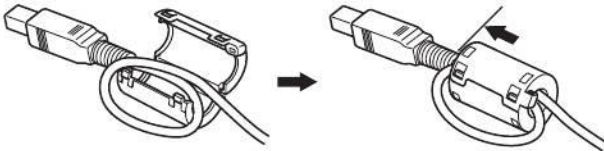
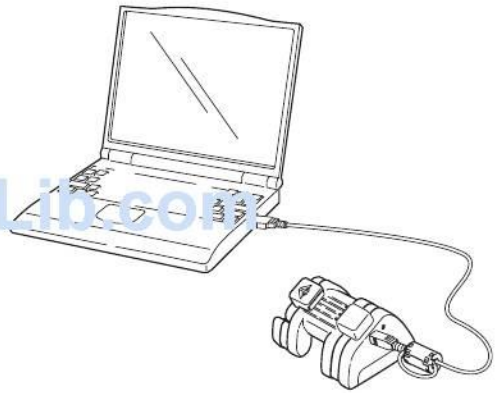

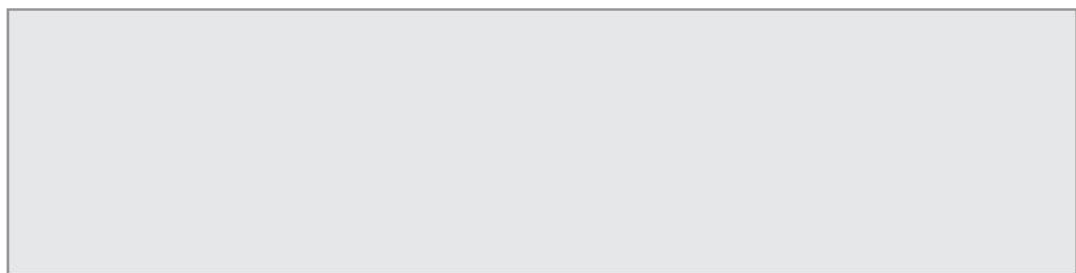

ManualsLib.com

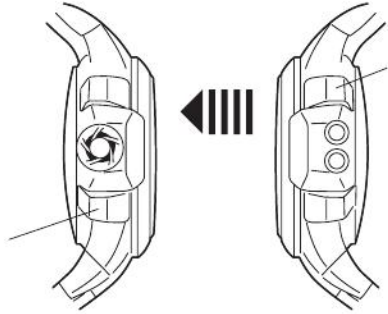

ManualsLib.com

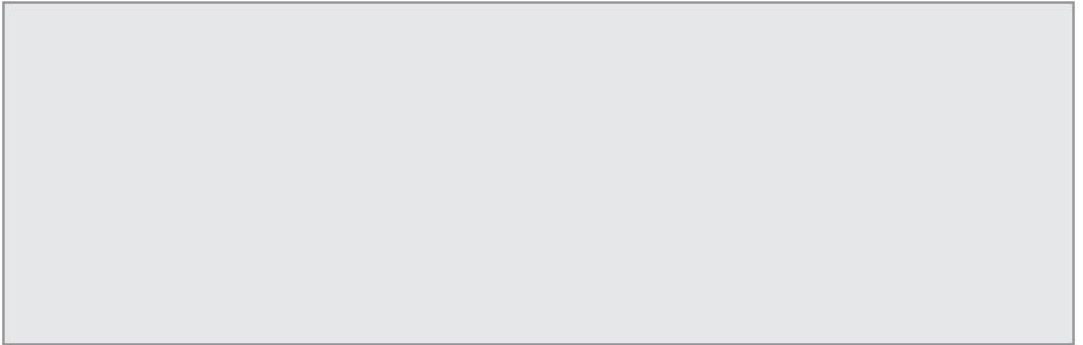

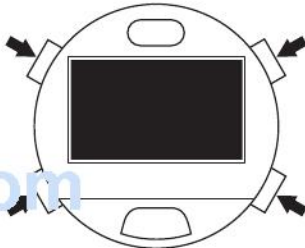

ManualsLib.com

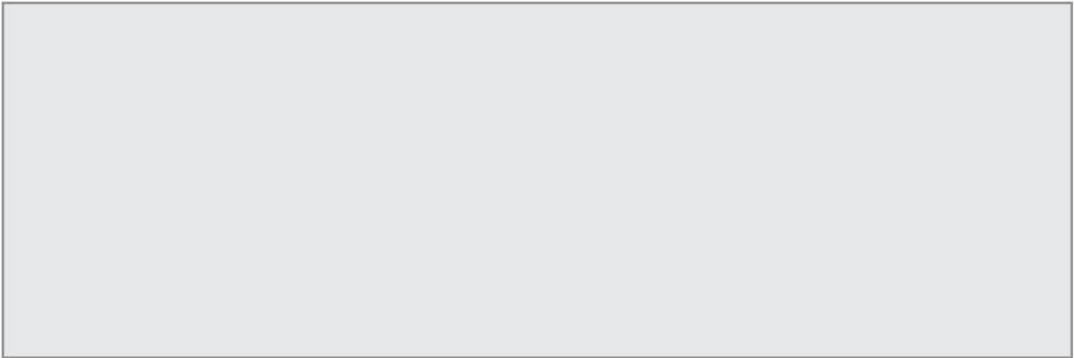



ManualsLib.com

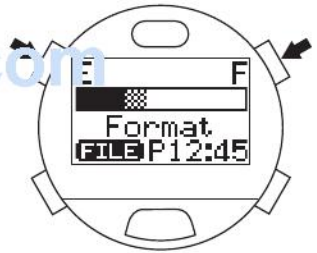

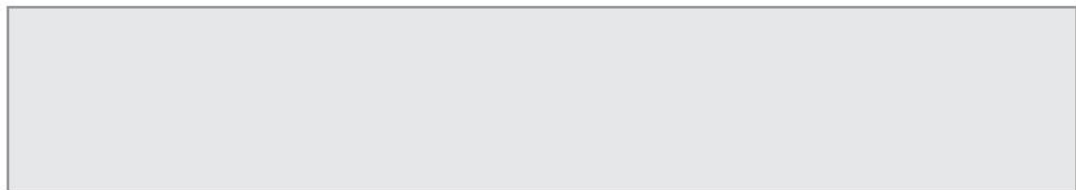

ManualsLib.com

ManualsLib.com



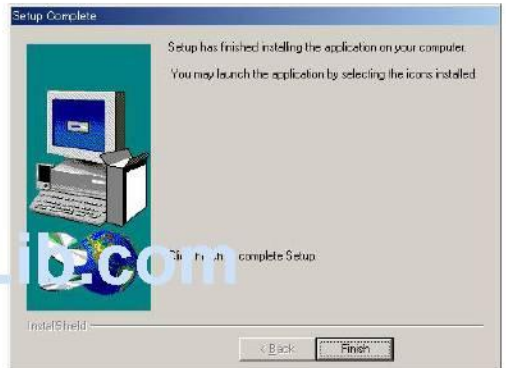

ManualsLib.com

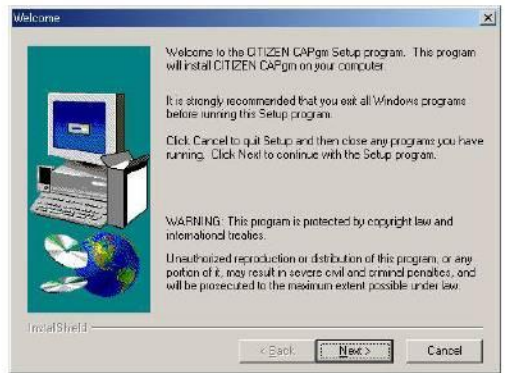

ManualsLib.com



ManualsLib.com

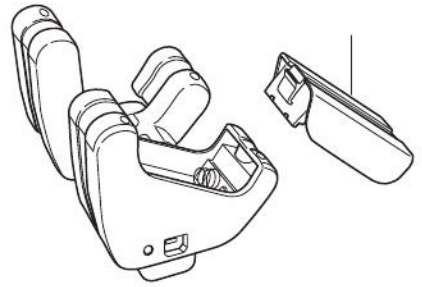
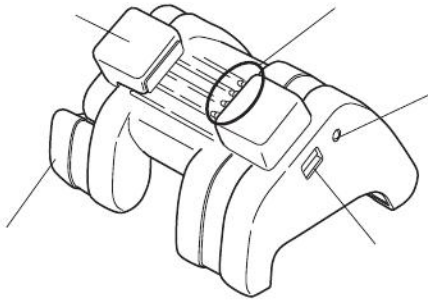

ManualsLib.com



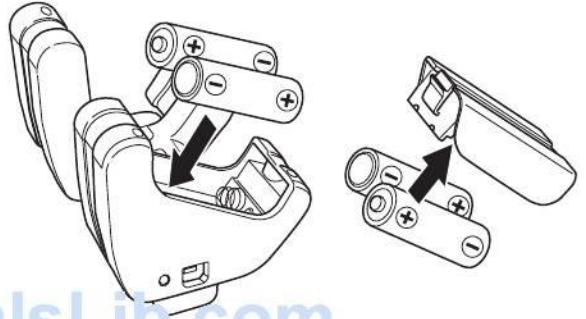
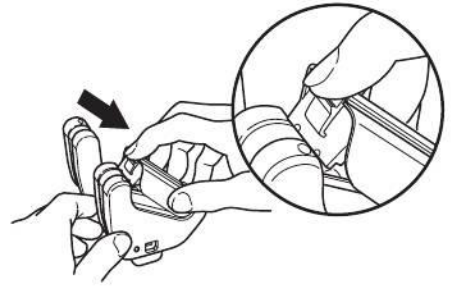

ManualsLib.com

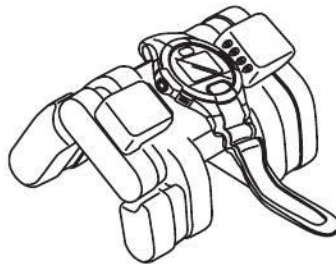

ManualsLib.com





ManualsLib.com







ManualsLib.com





ManualsLib.com



- (5) Confirm that [Install the software automatically {Recommended}] is selected and then click on “Next”. The software is automatically detected and will start installing it .
Notice: It may take some time to detect the software.

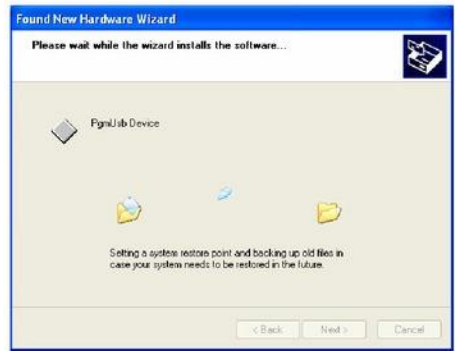
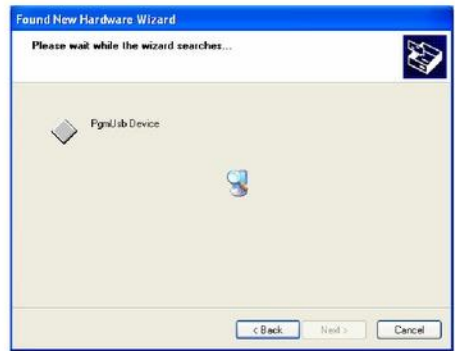

- (6) After installation is completed, the screen shown at right is displayed.
- (7) Click on “Finish”. Data can now be transferred using the USB interface.







- * After installing the USB driver, remove the CD-ROM from the CD-ROM drive and keep it in a safe place.
- * Installation of the USB driver is only performed once before transferring data using the communication unit for the first time. It is no longer required to be installed prior to subsequent data transfer. However, when transferring data using the communication unit for the first time with a different PC, the driver must again be installed in that PC.

	ManualsLib.com		

	ManualsLib.com		

ManualsLib.com





ManualsLib.com





ManualsLib.com



ManualsLib.com



ManualsLib.com

ManualsLib.com

ManualsLib.com