

CASIO®









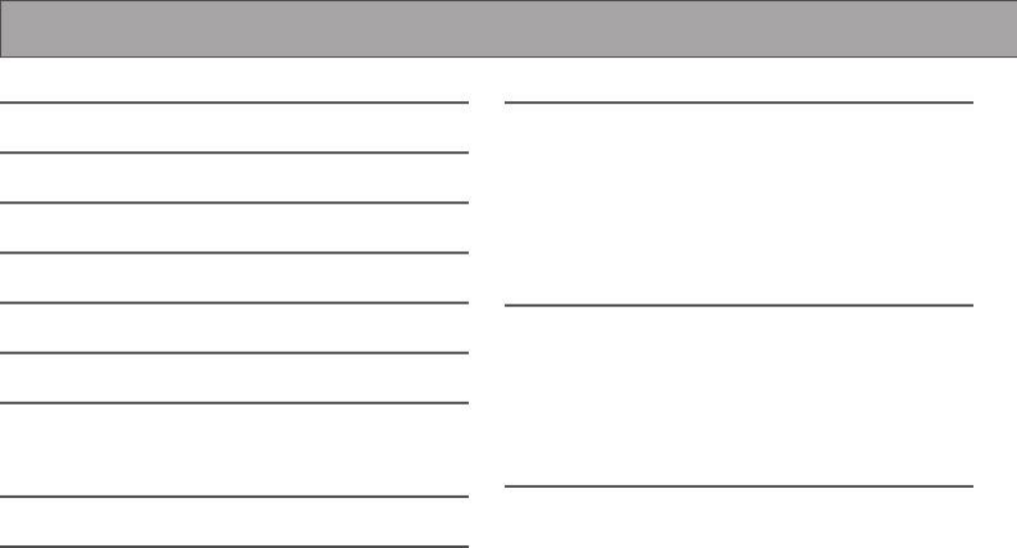





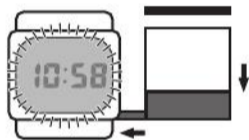
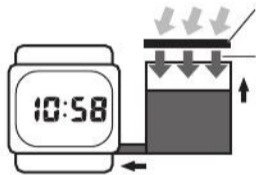

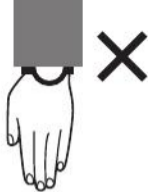
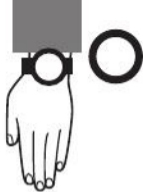
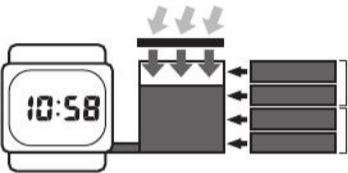

I



II

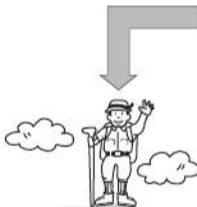







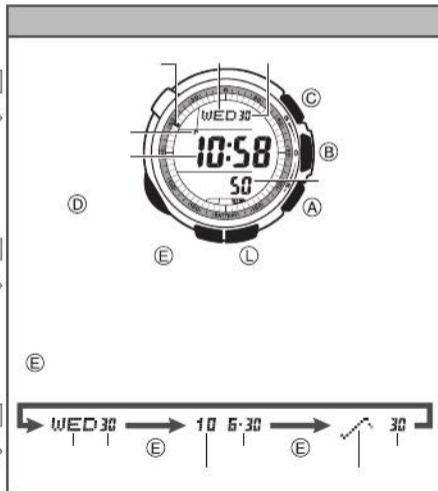

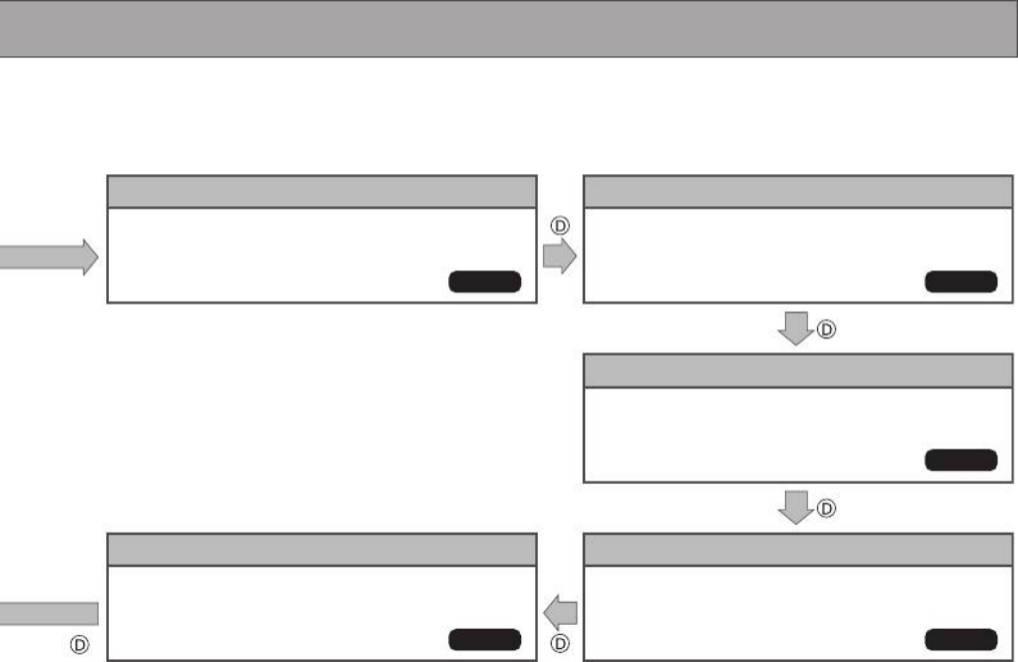
III

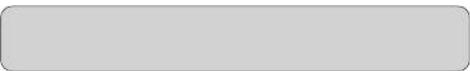













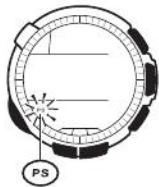

A.EL

A.EL

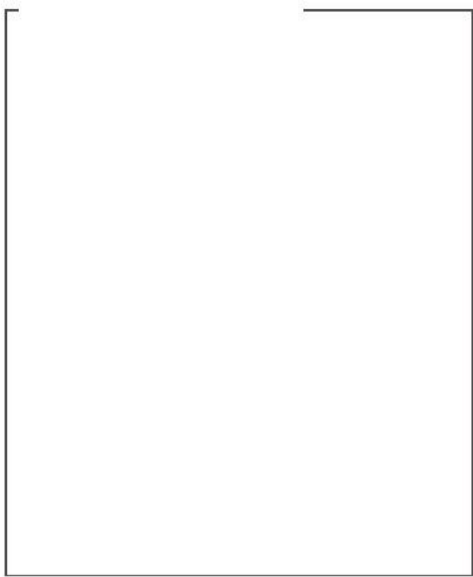
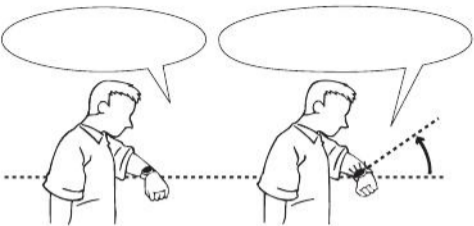

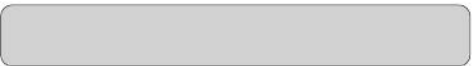
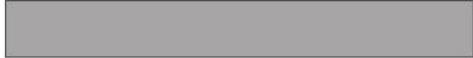
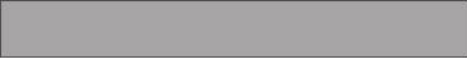

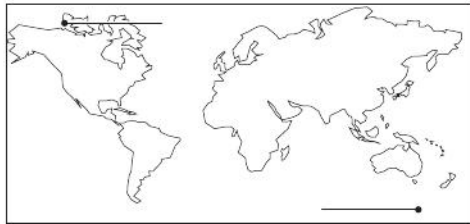

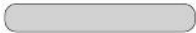

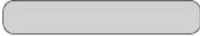

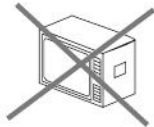
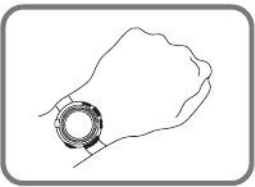
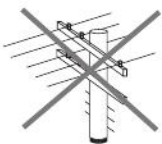
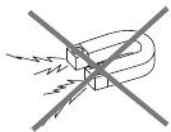
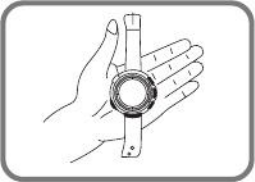

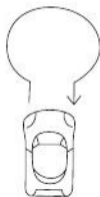
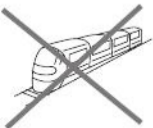

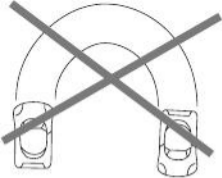

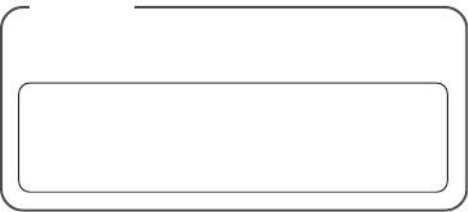

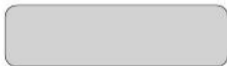
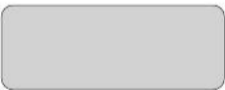
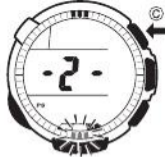
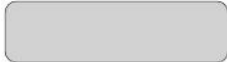
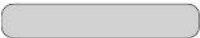

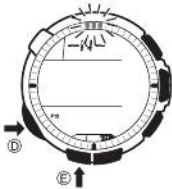
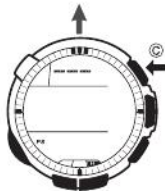

■ 方位計測の基準を「真北」に変更する（磁気偏角補正）

磁北と真北との角度の差（磁気偏角）の値をもとに補正を行なうと、「真北」を基準に方位を計測することができます。

● 「磁気偏角」の調べ方

- 地形図や登山地図のような等高線が描かれた地図に記載されています。
- 国土地理院のホームページ上で調べることができます。

● 本機で設定する「磁気偏角」について

- 本機では、ご使用になる地域の「磁気偏角の値」と「磁北が東偏か、西偏か」の2項目を設定します。
例えば、お調べになった資料に「磁針方位は西偏 約 7°」と記載されている場合は、「磁気偏角の値」には「7」を、「磁気偏角の方向」には「W」を設定してください。
- 本機に入力する「偏角値」は、1°（度）単位です。磁気偏角の値をお調べになった資料によっては、0.1°（度）単位、10'（分）単位などで表記されている場合があります。そのときは、以下の例を参考に、1°（度）単位に換算してください。

〔例1〕 7.0° ~ 7.4° : 7°
7.5° : 7° または 8°
7.6° ~ 7.9° : 8°

〔例2〕 7° 00' ~ 7° 20' : 7°
7° 30' : 7° または 8°
7° 40' ~ 7° 50' : 8°

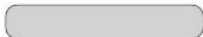
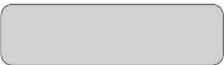
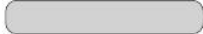

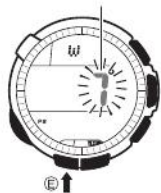
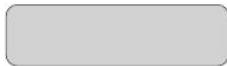
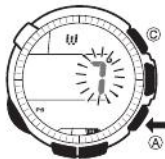
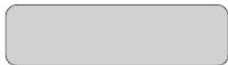
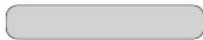
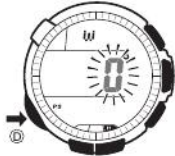
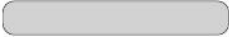

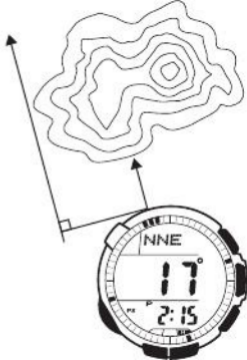

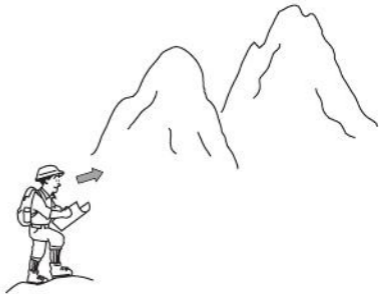

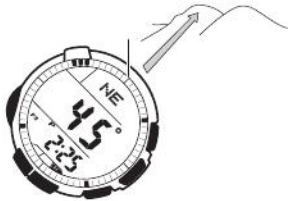
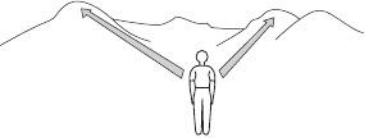

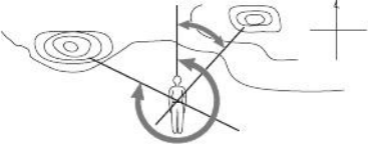

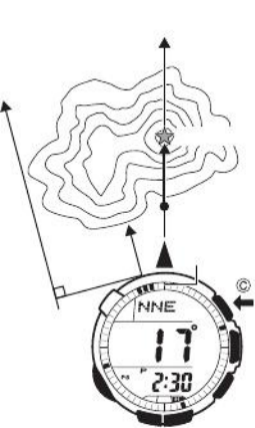

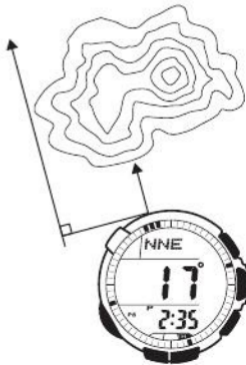
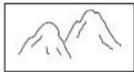





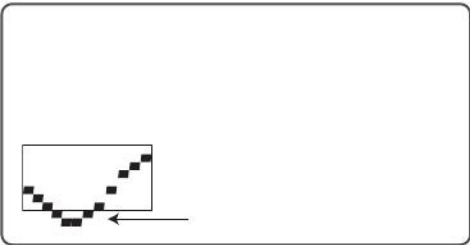



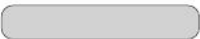
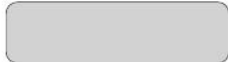
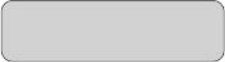

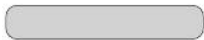

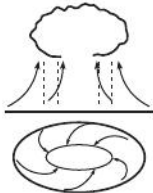
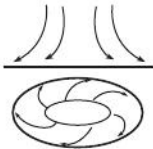









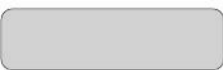

E ↑

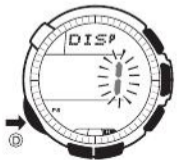
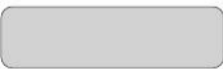
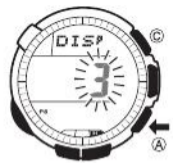
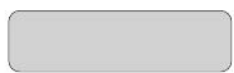

D ↓

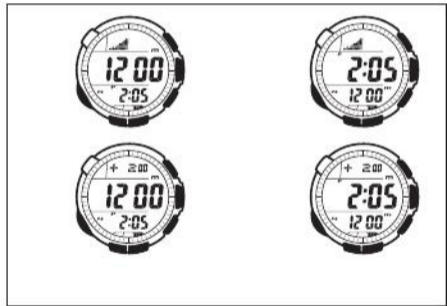

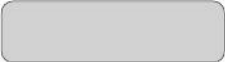

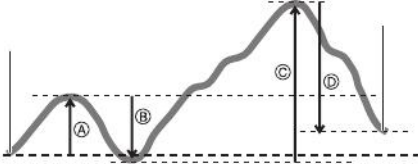

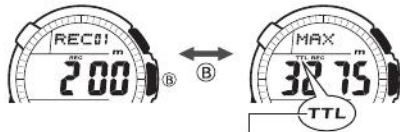

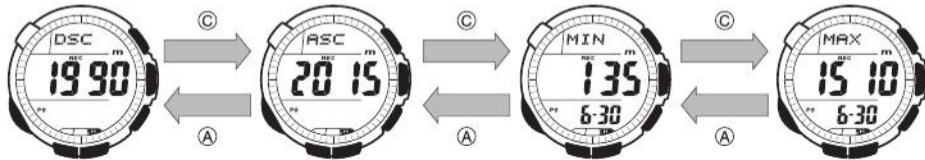
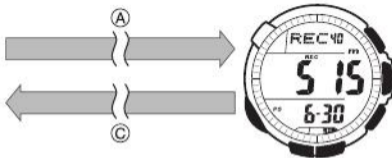
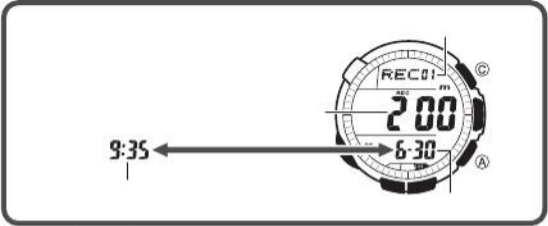

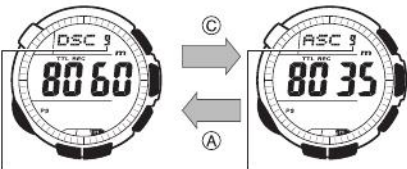
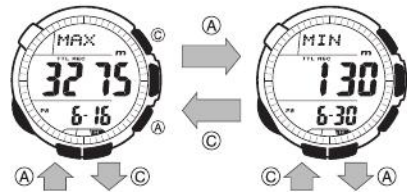

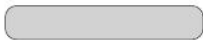

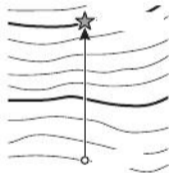

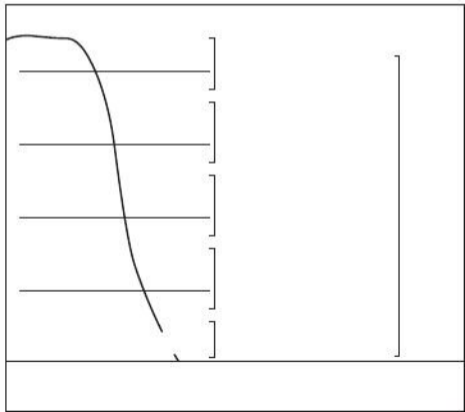

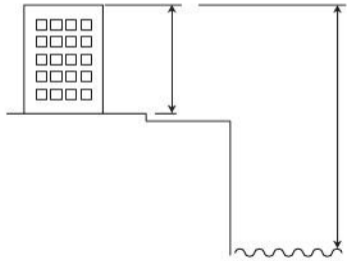
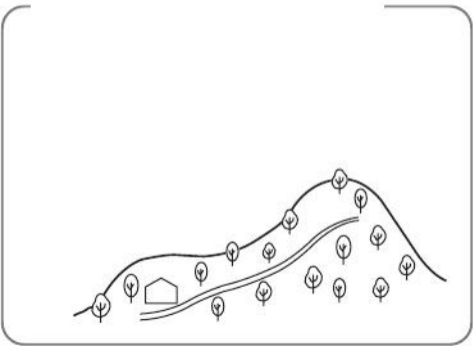

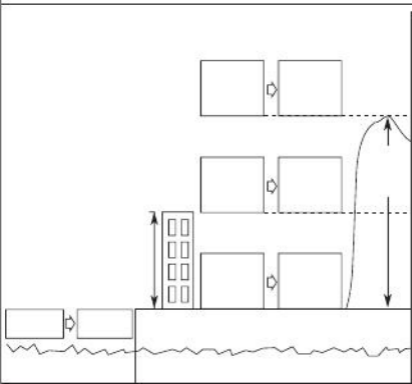

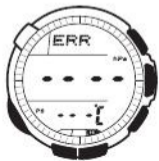

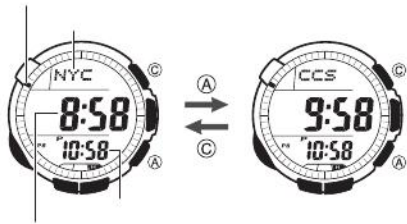
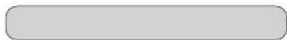



A → A → C

A → C → C → A → C



A → C → A → C → C

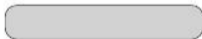
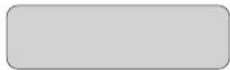

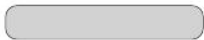

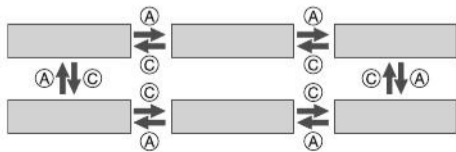
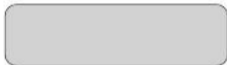
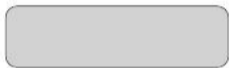

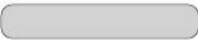
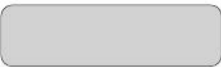

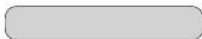
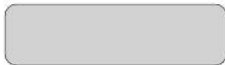
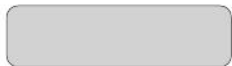

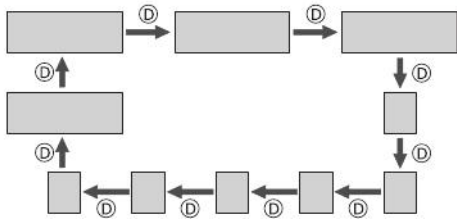
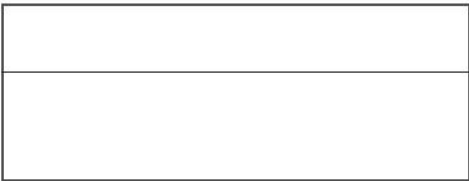





WENT TO

MENTING

WENT TO



		<input type="radio"/>	<input type="radio"/>	<input type="radio"/>	<input type="radio"/>
		<input checked="" type="checkbox"/>	<input type="radio"/>	<input type="radio"/>	<input type="radio"/>
		<input checked="" type="checkbox"/>	<input checked="" type="checkbox"/>	<input type="radio"/>	<input type="radio"/>
		<input checked="" type="checkbox"/>	<input checked="" type="checkbox"/>	<input type="radio"/>	<input type="radio"/>



