



Citrea

Instruction
Manual

GET STARTED

1. Charge

Connect and charge the smartwatch to activate the smartwatch when it is started for the first time.

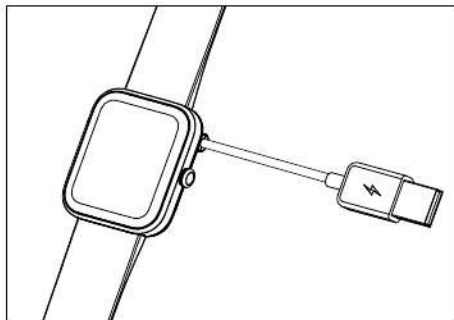
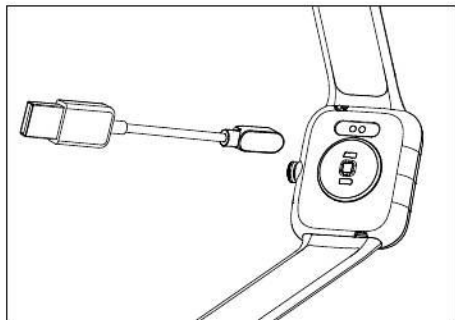

2. Wear

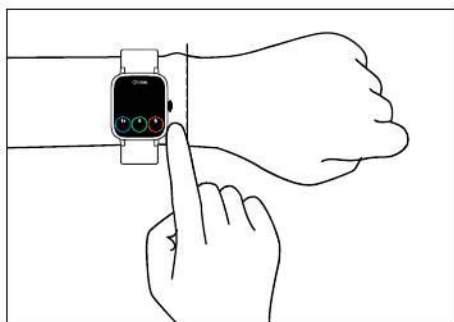

Wear the device a finger's distance from the wrist bone and adjust the tightness of the strap to a comfortable position.

Note: Wearing too loosely may affect the accuracy of heart rate data.

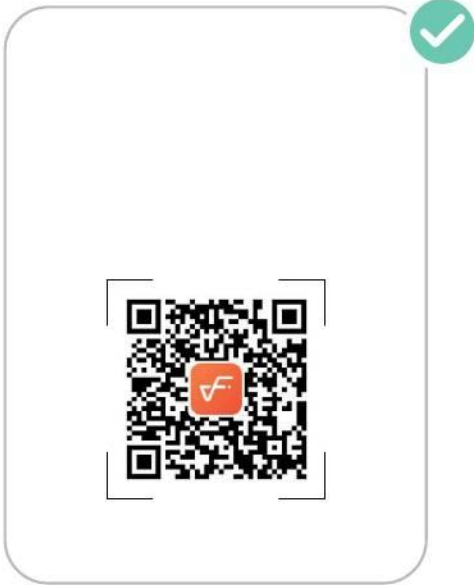

-
-
-
-

PAIR

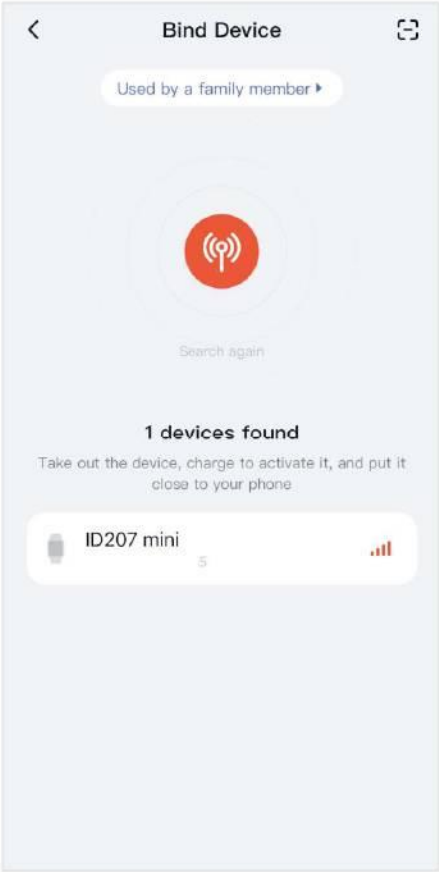

PAIR

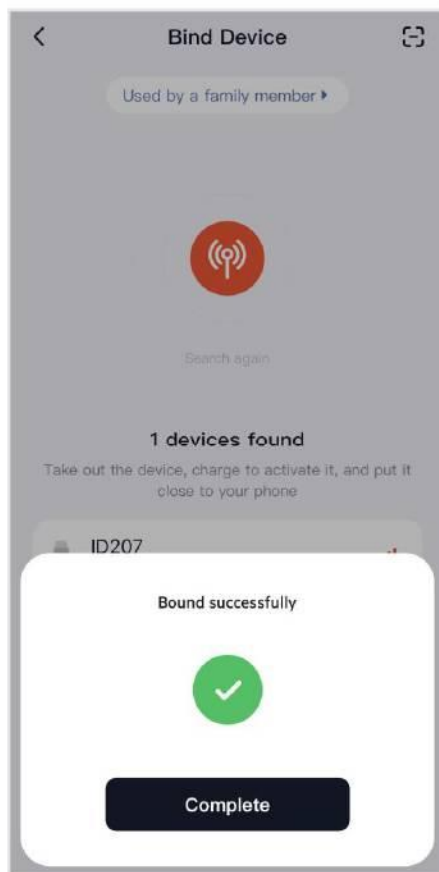
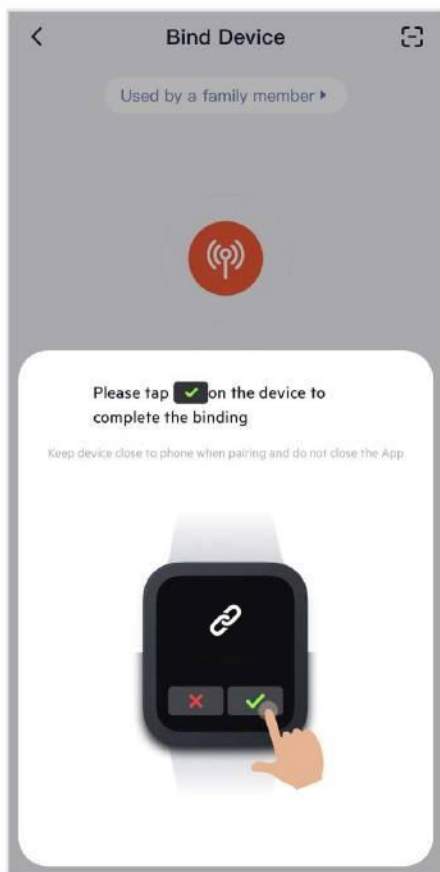

*

*

FUNCTIONS

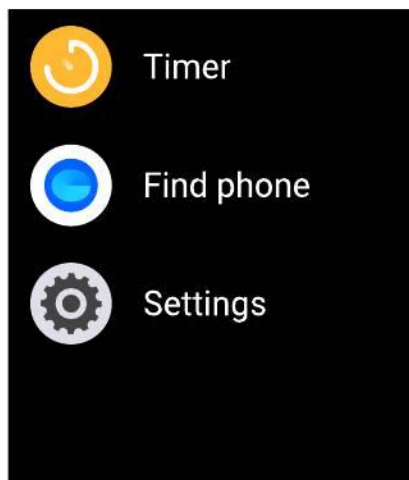
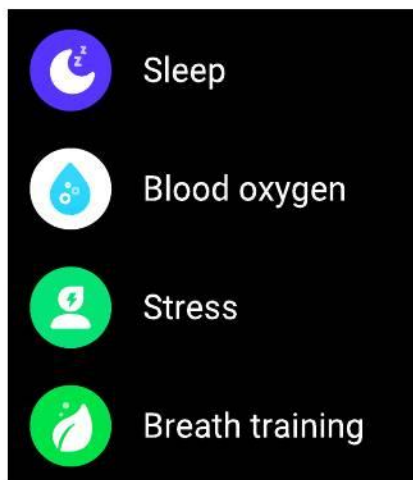
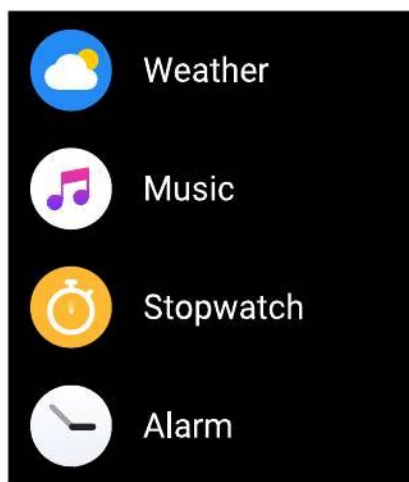
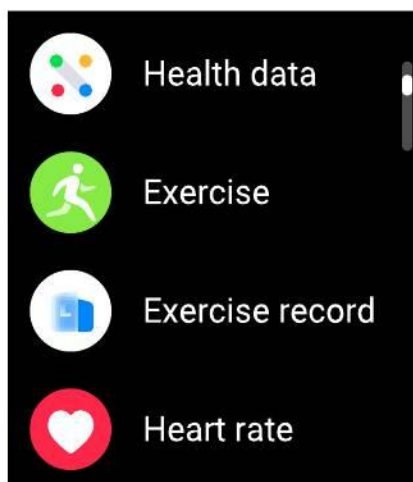

FUNCTIONS



Keep track of your daily steps



Keep track of your daily distance



Keep track of your daily calories burnt



Get notifications and read messages



Perform a heart rate test to check your heart rate data for the day



Note: For more functions and operation, please check VeryFit software of the mobile phone.

WATCH FACE

Built-in

Choose one from the 3 built-in watch faces



Step, Calory, Km/Mile



Step

Date chosen one from 7 languages:

English, Spanish, German, Italian, French, Swedish, Japanese

Cloud (Date supported only in English)

Download one from VeryFit App



Step, Calory



Step, Calory, Km/Mile



Step, Calory



Step, Calory, Km/Mile



Step, Calory, Km/Mile

Note: For more Cloud Watch Face, please check VeryFit software of the mobile phone.

WATCH FACE

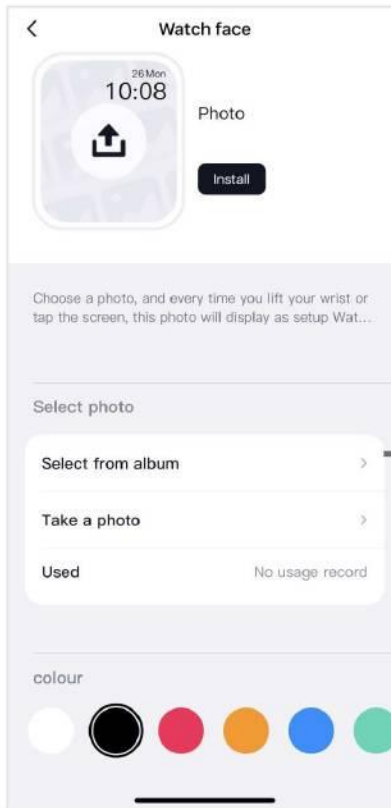
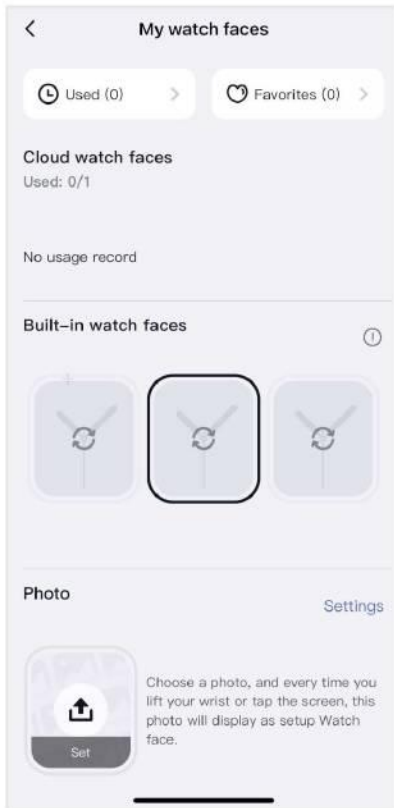

Note: Please enjoy this function with only the photos you take.

	°C ~ °C
	°C ~ °C
	~
	-



-
-
-

MAINTENANCE

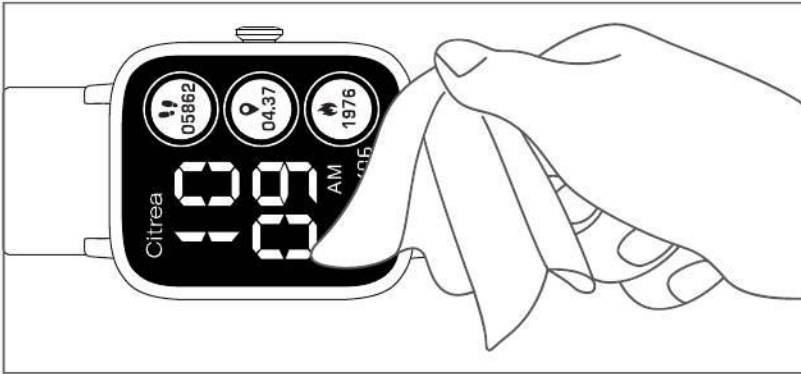

It is recommended to wear and maintain according to the following three points:

- ① Keep the product clean;
 - ② Keep the product dry;
 - ③ Do not wear the product too tight.
-
- ★ Do not use household cleaners to clean the smartwatch, but use the soap free detergent.
 - ★ It is recommended to use alcohol to scrub stains that are not easy to remove.

①

②

③

①

②

③

①

②

③

①

②

*





Warning

CYCLING WARNING

Please maintain good judgment at all times and ride in safe manner. Make sure your bike and hardware are properly maintained, and all components are properly installed.

MATTERS NEEDING ATTENTION

- Smartwatch data needs to be kept once every 7 days to avoid data loss.
- The smartwatch has no waterproof effect on seawater, acidic and alkaline solutions, chemical reagents and other corrosive liquid.
- Sports mode supports up to 6 hours of exercise at a time.
- Avoid wearing the smartwatch too tight in daily use. Please keep the parts of the smartwatch touching the skin dry.
- When your heart rate is measured, keep your arm still during the test.



The device meets the EU RoHS criterion.

Please refer to IEC 62321, EU RoHS Directive 2011/65/EU and revised directive.

CE / UKCA

CITIZEN WATCH CO., LTD hereby declares that this product is in the compliance with the essential requirements and other relevant provisions of directives 2011/65/EU, the Restriction of the Use of Certain Hazardous Substances in Electrical and Electronic Equipment legislations 2012 and all other relevant EU directives and UK legislations.

You can find your product's Declaration of Conformity at

"<https://qq-watch.jp/eng/citrea/>"



FCC

This device complies with Part 15 of the FCC Rules. Operation is subject to the following two conditions:

- (1) this device may not cause harmful interference, and
- (2) this device must accept any interference received, including interference that may cause undesired operation.

Changes or modifications not expressly approved by the party responsible for compliance could void the user's authority to operate the equipment. This equipment has been tested and found to comply with the limits for a Class B digital device, pursuant to Part 15 of the FCC Rules. These limits are designed to provide reasonable protection against harmful interference in a residential installation. This equipment generates, uses and can radiate radio frequency energy and, if not installed and used in accordance with the instructions, may cause harmful to radio communications. However, there is no guarantee that interference will not occur in a particular installation.

If this equipment does cause harmful interference to radio or television reception, which can be determined by turning the equipment off and on, the user is encouraged to try to correct the interference by one or more of the following measures:

- Reorient or relocate the receiving antenna.
- Increase the separation between the equipment and receiver.
- Connect the equipment into an outlet on a circuit different from that to which the receiver is connected.
- Consult the dealer or an experienced radio/TV technician for help.

CAUTION

Risk of explosion if battery is replaced by an incorrect type.
Dispose of used batteries according to local environmental regulations.



Old electrical appliances must not be disposed of together with the residual waste, but have to be disposed of separately. The disposal at the communal collecting point via private persons is for free. The owner of old appliances is responsible to bring the appliances to these collection points or to similar collection points. With this little personal effort, you contribute to recycle valuable raw materials and the treatment of toxic substances.

■ IMPORTER:

■ MANUFACTURER:

CITIZEN WATCH CO., LTD.
Q&Q SALES DEPARTMENT
6-1-12, Tanashi-cho, Nishi-Tokyo-shi,
Tokyo 188-8511, Japan