 <p>A diagram of a steering wheel with a central hub and a spoke. The letters 'SFTWTMS' are arranged in a semi-circle along the bottom edge of the wheel. On the left side, there is a label 'STD' with a small rectangular icon. On the right side, there is a label 'SMT' with a small rectangular icon. A dashed line connects the left side of the wheel to a callout box above it.</p>	
	 <p>A diagram of a steering wheel with a central hub and a spoke. The letters 'SFTWTMS' are arranged in a semi-circle along the bottom edge of the wheel. On the left side, there is a label 'STD' with a small rectangular icon. On the right side, there is a label 'SMT' with a small rectangular icon. A dashed line connects the right side of the wheel to a callout box above it.</p>

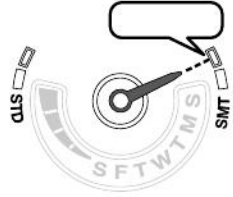

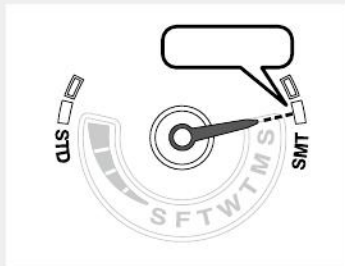

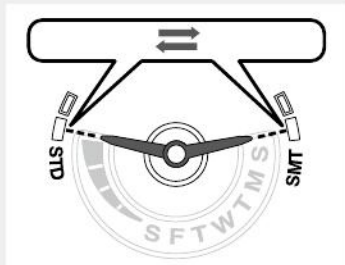

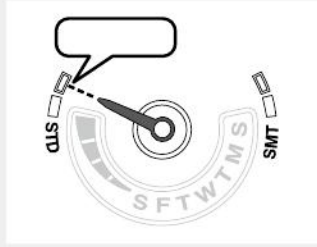

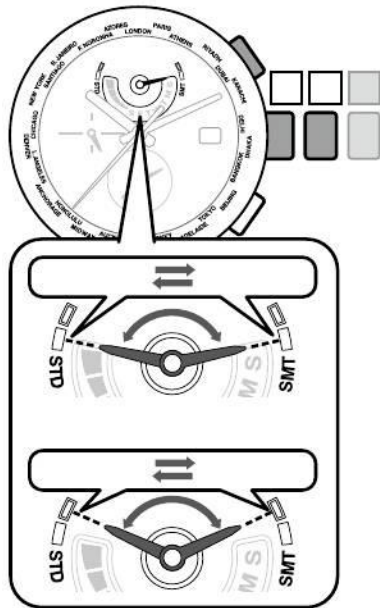
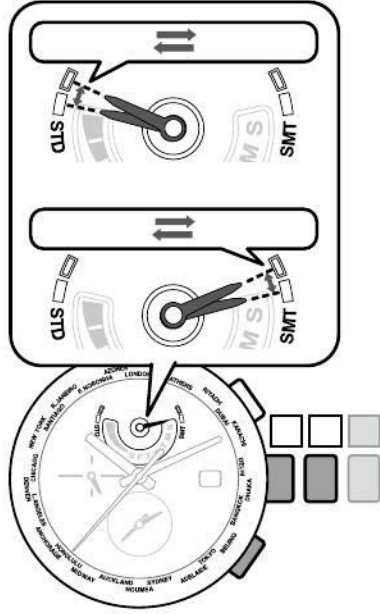



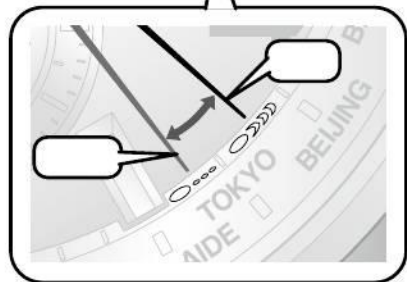
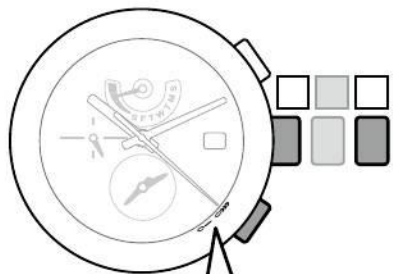

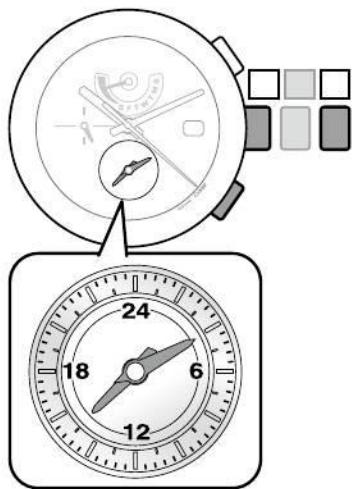

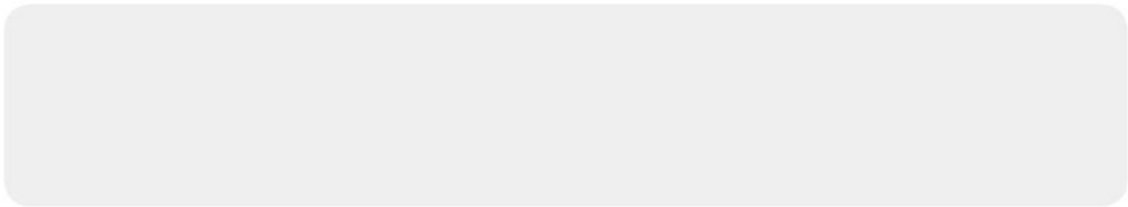

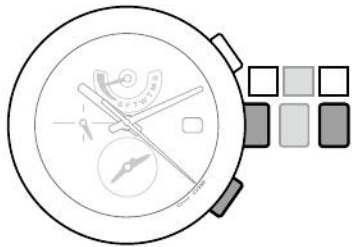





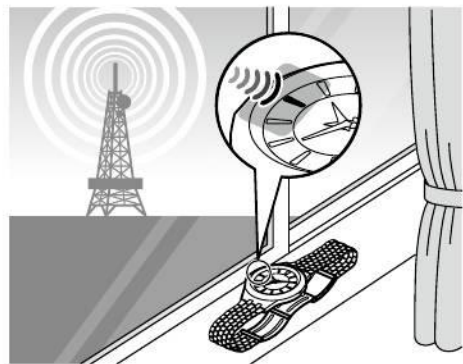

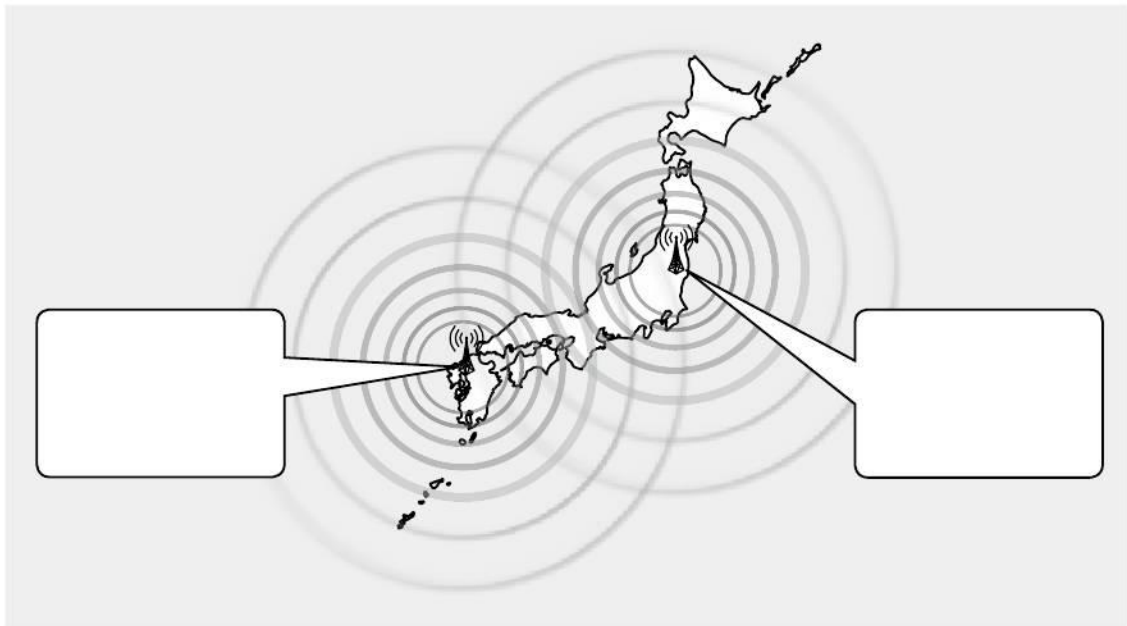





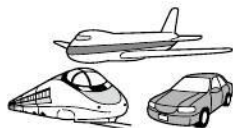



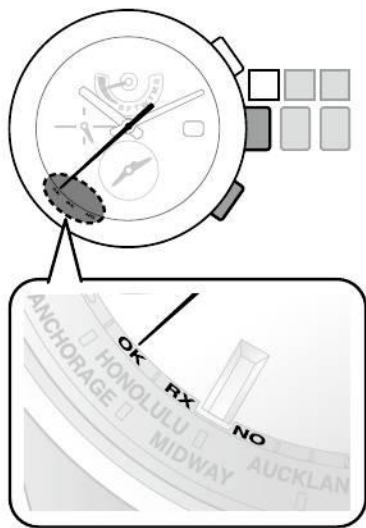

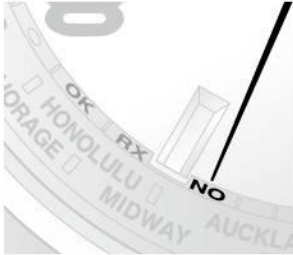

	 <p>A close-up of a radio tuner scale. The scale is curved and has several markings: 'OK', 'HONOLULU', 'MIDWAY', 'AUCKLAND', 'NO', and 'RX'. A black pointer is pointing to the 'OK' marking. The 'RX' marking is to the right of 'OK', and 'NO' is to the right of 'RX'. The 'HONOLULU' and 'MIDWAY' markings are to the left of 'OK'. The 'AUCKLAND' marking is to the right of 'NO'. The scale is part of a larger device, with a '0' visible at the top left.</p>	 <p>A close-up of a radio tuner scale. The scale is curved and has several markings: 'OK', 'HONOLULU', 'MIDWAY', 'AUCKLAND', 'NO', and 'RX'. A black pointer is pointing to the 'NO' marking. The 'RX' marking is to the left of 'NO', and 'OK' is to the left of 'RX'. The 'HONOLULU' and 'MIDWAY' markings are to the left of 'OK'. The 'AUCKLAND' marking is to the right of 'NO'. The scale is part of a larger device, with a '0' visible at the top left.</p>	 <p>A close-up of a radio tuner scale. The scale is curved and has several markings: 'OK', 'HONOLULU', 'MIDWAY', 'AUCKLAND', 'NO', and 'RX'. A black pointer is pointing to the 'RX' marking. The 'OK' marking is to the left of 'RX', and 'NO' is to the right of 'RX'. The 'HONOLULU' and 'MIDWAY' markings are to the left of 'OK'. The 'AUCKLAND' marking is to the right of 'NO'. The scale is part of a larger device, with a '0' visible at the top left.</p>

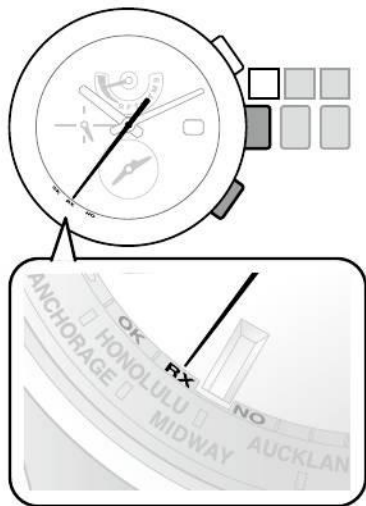



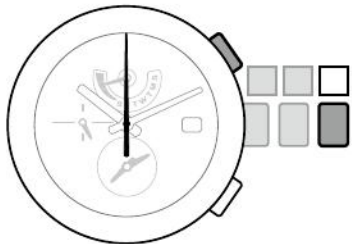
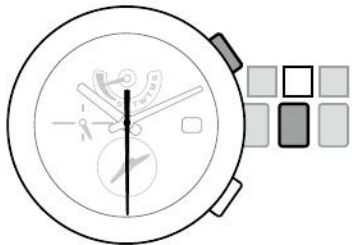

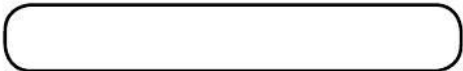
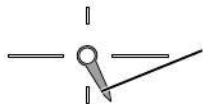
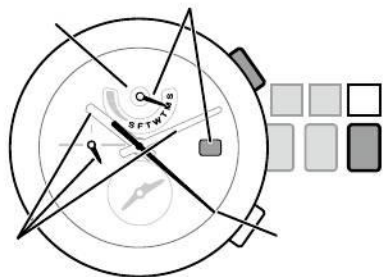



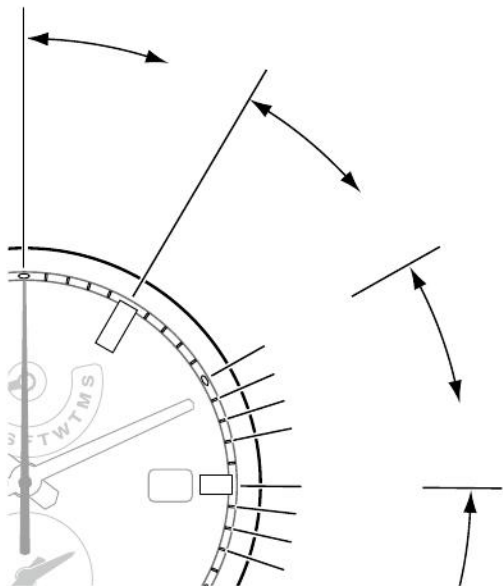

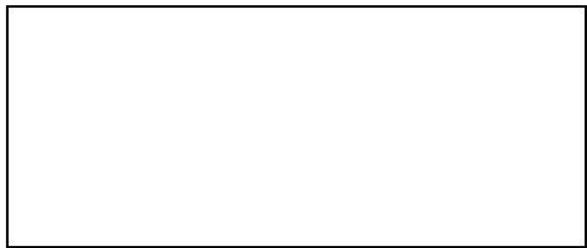
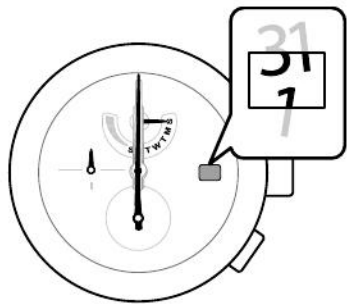

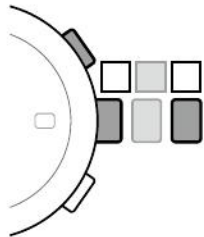

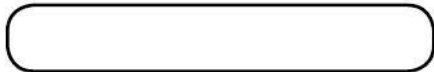
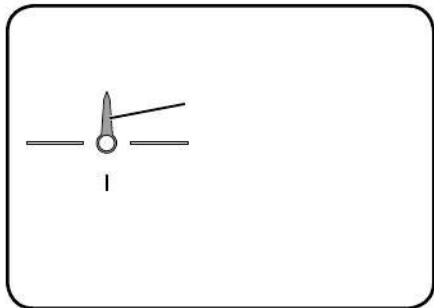
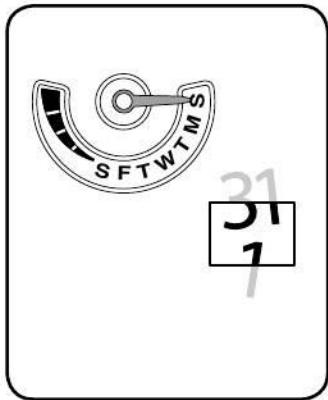
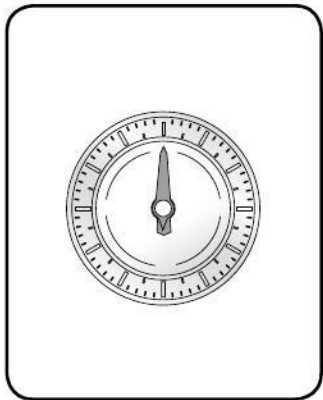
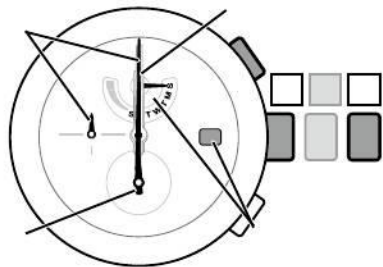



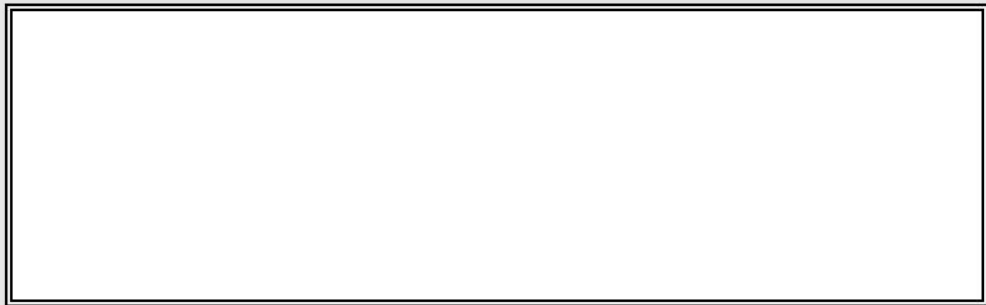

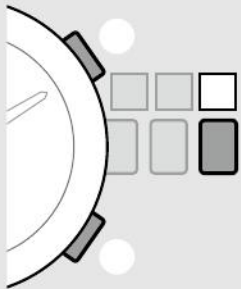

















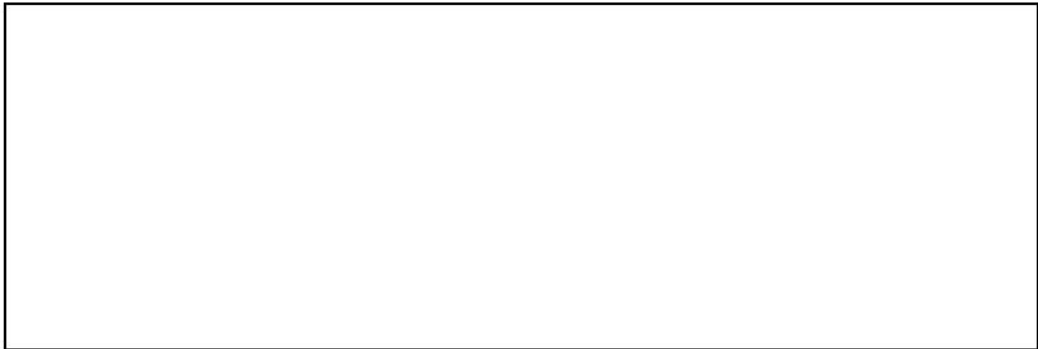



--	--

CE

