

Dive computer watch
CYBER AQUALAND™ Nx

INSTRUCTION MANUAL

D710/D716

 **CITIZEN**
CITIZEN IS A REGISTERED TRADEMARK OF CITIZEN WATCH CO., JAPAN.

Unauthorized reproduction of any or all of this manual is strictly prohibited.
The contents of this manual are subject to change without notice.

The manufacturer is not responsible for any or all damages, lost profits or demands from a third party resulting from use of this manual or products described therein.

- Windows 98, Windows 98SE, Windows Me, Windows 2000 and Windows XP are registered trademarks or trademarks of the Microsoft Corporation, USA.
- Other firm names and product names contained in this manual are also the registered trademarks or trademarks of their respective firms.
- The algorithm of this dive computer is licenced from the Defence and Civil Institute of Environmental Medicine (DCIEM) of Canada.

Before Using

Please make sure to adequately charge the watch using the charger provided.

This watch is rechargeable.

The watch display has been turned off prior to shipment from the factory in order to reduce power consumption by the energy storage cell of the watch.

* Remove the display seal affixed to the watch display before using the watch.

Before using, fully charge the watch by following the procedure described below.

The display can then be illuminated by performing the all-reset procedure.

* Refer to the section entitled, "Charger", for details on the procedure for installing the 4 pcs. of size AA alkaline batteries and the procedure for charging the watch.

- (1) Install 4 pcs. of size AA alkaline batteries in the charger provided.

Charger

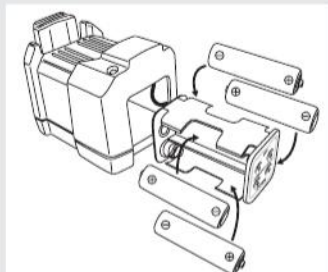

- (2) Place the watch in the charger and charge the watch until the LED on top of the charger goes out. (It takes about 7 hours to fully charge the watch.)

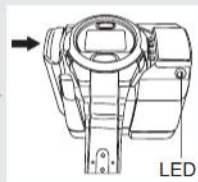

*** We advise recharging to be done at stable flat surface to avoid unexpected disengagement of the watch.**

- (3) When the lower right button (A), upper right button (B), upper left button (C) and lower left button (D) are pressed simultaneously and released, an alarm tone sounds after "INITIALIZE" is displayed and the entire display is illuminated (all-reset).
- (4) When any one of the buttons is pressed and released, the time and date are displayed after "LOADING" is displayed.

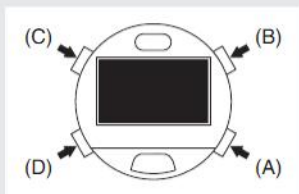

- (5) Correctly set the time, date and each mode by referring to the respective sections of the instruction manual.

* Refer to "Using the Standard Mode: 1. Using the Time Mode" of this manual for information on correcting the time and date.

Introduction

Thank you for your purchase of this Citizen CYBER AQUALAND Nx. Please make sure to read this manual carefully before using your watch to ensure that it is used properly. Furthermore, store this manual in a safe place for future reference as necessary.

CYBER AQUALAND Nx is a divers watch equipped with its own depth gauge, and features an internal dive computer compatible with both NITROX and high-altitude diving. The watch automatically stores various data (including maximum depth, dive time and other parameters) as well as diving profile data during diving, and displays that data in the form of log data.

Diving data stored in the watch can be loaded into a personal computer using an infrared communication interface or separately sold communication unit (USB interface) by installing AQUALAND GRAPH Nx in your personal computer from the CD-ROM disc provided.

Once diving data has been loaded into your personal computer, you can enter characters, generate graphs of diving data or paste still images or animated data, and manage them collectively in the form of a daily log. Since the daily log can be printed out or converted to an HTML format, it offers considerable convenience in storing diving records.

In addition, installing the CAPgm software provided with the watch not only lets you set various functions of the watch (travel time, alarm time, timer setting and so forth) on your personal computer, but also lets you display your favorite graphic on the watch display on different days of the week.

We hope that the use of your CYBER AQUALAND Nx will let you get more enjoyment from your diving.

*** For Customers Using Our Existing CYBER AQUALAND (Movement No. D70*) and HYPER AQUALAND (Movement No. D20*) Products:**

- In the case of using CYBER AQUALAND or HYPER AQUALAND software, existing diving data managed with the respective versions of AQUALAND GRAPH can continue to be used by importing to AQUALAND GRAPH Nx.
- CYBER AQUALAND and HYPER AQUALAND data can be received using AQUALAND GRAPH Nx. However, the communication unit and connection cable for use with HYPER AQUALAND are required to receive data from HYPER AQUALAND.
- The communication unit and USB cable provided with CYBER AQUALAND can continue to be used as a charger and USB interface for CYBER AQUALAND Nx.
(Please refer to the AQUALAND GRAPH Nx instruction manual contained on the CD-ROM provided for further information regarding the procedures for importing and receiving data.)

Safety Precautions: Observe at All Times

The following provides an explanation of those matters that should be observed at all times to prevent injury to the wearer or other persons as well as damage to property before they occur.

Important Notes

- The degree of injury or damage resulting from incorrect use while ignoring the indicated matters is classified and explained using the following markings.



DANGER

This marking indicates matters for which there is a high risk of death or serious injury.



WARNING

This marking indicates matters for which there is the risk of death or serious injury.



CAUTION

This marking indicates matters for which there is the risk of injury or property damage only.

- The types of matters to be observed are classified and explained using the following mark (the following indicates two examples of icons).



This mark indicates that caution or attention is required.



This mark indicates prohibited matters.



WARNING

Read this manual carefully and pay attention to all dangers, warnings and cautions. Make sure you fully understand the use, displays and limitations of the watch. Neglecting to understand and follow the instruction manual may cause errors to be made during diving that may lead to serious injury or death.

Diving is a potentially dangerous sport. When using this watch for diving, make sure to have a correct understanding of this watch as described in this manual and strictly adhere to the procedures for its operation.

The watch may not function properly if handled in a manner not described in this manual.

General Cautions Regarding Diving



WARNING

In the case of using this watch for diving, always make sure to receive the proper scuba diving training from a certified instructor so that you have the necessary experience and skills required for safe diving. In addition, make sure that you have completely mastered the handling and operation of this watch.

Even though you may only be engaged in recreational diving, any type of diving can be potentially dangerous. Attempting to engage in diving with improper or inadequate training can result in a fatal or serious accident.



WARNING

Never attempt NITROX diving unless you have received special training for NITROX diving.

Although this watch is also compatible with NITROX diving, NITROX diving presents serious or potentially fatal risks unlike ordinary diving using compressed air.



WARNING

Each diver should be responsible for formulating and executing a diving plan to ensure safety that matches his or her own abilities.

The dive computer function of this watch is not designed to completely prevent the occurrence of decompression sickness. In addition, it is unable to monitor differences in the physiological functions of individual divers or differences in physical condition on a particular day. Since physical condition has a considerable effect on the occurrence of decompression sickness, the degree of the risk of decompression sickness varies depending on the physical condition of the diver on that day. It is therefore recommended to avoid diving when physical condition is poor, such as in the case of illness, fatigue, lack of sleep or hangover.

Cautions Regarding Use of this Watch



DANGER

Do not use this watch during decompression diving, especially during NITROX diving.

Although this watch will provide data on decompression diving in an emergency, using this watch for decompression diving entails risks. Since decompression diving during NITROX diving in particular is very dangerous, never use this watch under these conditions. Decompression diving during NITROX diving can lead to an accident causing death or serious injury. (The DCIEM algorithm generates a particularly hard error in the case of decompression diving during NITROX diving.)



DANGER

Never loan or share the watch with another person when resting on the surface (while the watch is operating in the surface mode). In addition, do not use the data displayed by the watch as the data for a person other than the user.

This watch is designed on the premise of use by a single user. Since calculations made by the dive computer based on previous diving are continued to be used during operation in the surface mode, use of the watch by another person can prevent the dive computer from making calculations suitable for the user, resulting in the risk of an accident causing death or serious injury.



DANGER

Avoid traveling in an aircraft while the surface mode is activated.

Traveling in an aircraft without allowing sufficient time to rest after diving results in the risk of decompression sickness. It is recommended to avoid traveling in an aircraft for at least 24 hours after diving whenever possible even if the surface mode is no longer displayed. There are no rules for completely preventing decompression sickness caused by flying in an aircraft after diving.



WARNING

In the case of using this watch for diving, always make sure to also use other backup equipment (including a DCIEM dive table, divers watch, residual pressure gauge and water depth gauge).

Sudden fluctuations in the atmosphere and changes in water temperature may have an effect on the display and performance of the watch. Always make sure to use this watch in combination with other backup instruments in case the watch should happen to malfunction. The dive computer functions of this watch are not intended to completely protect you from decompression sickness and oxygen toxication. Since the watch is only intended to display information to serve as a reference for minimizing the risk of decompression sickness and so forth, it is not intended to completely ensure the safety of the user.



WARNING

Always make sure to inspect all functions of the watch prior to each dive to prevent malfunction of the watch and accidents caused by use of the watch at improper settings. (Refer to the section entitled, “Cautions Regarding Use During Diving” (p. 17), for information on the inspection procedure.) In particular, always make sure to check whether the watch is sufficiently charged, whether the oxygen concentration (O₂%) is set correctly, and whether there are warnings being displayed.



WARNING

Diving when using this watch is limited to recreational diving at a water temperature from +10°C to +40°C (50°F to 104°F).

Do not use this watch for saturation diving using helium gas, diving at a water temperature outside the above temperature range or high-altitude diving at 3,000 m (10,000 ft) above sea level or higher since this can prevent the watch from functioning properly or lead to an accident resulting in danger. In addition, this watch does not display depth properly when used in water other than seawater (specific gravity of 1.025).



WARNING

In order to ensure safe diving, dive while allowing an adequate margin of safety relative to the displayed no-decompression limit time.



WARNING

If decompression diving should happen to occur, immediately start to ascend while observing an ascent rate of no more than 18 m (60 ft)/min.

Since decompression diving is associated with a high risk of decompression sickness, observe the following matters at all times.

- Make a decompression stop while ascending in accordance with decompression stop instructions.
- When making a decompression stop, never ascend to a depth less than the instructed depth.
- Since it is difficult to maintain a constant depth when there are high waves and so forth, make decompression stops at depths a little deeper than the instructed depth to prevent decompression sickness.

* A permanent error (ERROR) occurs when continuing to dive while ignoring decompression stop instructions during the course of decompression diving, and the watch will not switch to the dive mode for 24 hours after that time.



WARNING

Skin diving after scuba diving is not recommended since it can have a serious effect on your health. It is recommended to avoid skin diving for at least two hours after scuba diving and not to exceed a depth of 5 m (15 ft).



CAUTION Data Storage

Always make sure to keep a separate record of important data recorded in the watch.

Diving data in particular should be transferred to your PC or recorded in a log book as quickly as possible. The various data recorded in the watch may be lost when subjected to incorrect use or the effects of strong electricity and electrical noise as well as during a malfunction and repair.

CONTENTS

Before Using	3
Introduction	4
Checking Accessories	14
Cautions Regarding Use During Diving	15
Features	18
Charger	20
1. Names and Functions of Components	20
2. 4 pcs. of size AA Alkaline Batteries Installation Procedure	21
3. Charging the Watch	22
Names of Components	24
Watch Display Modes (Functions)	24
Charge Level Indicator and Continuous Usage Time	26
1. How to Read the Charge Level Indicator of the watch	26
2. Continuous Usage Time	27
Using the EL Light	27
Switching the Mode	28
Using the Standard Mode	30
1. Using the Time Mode	30
A. Switching the Display	30
B. Setting the Time and Date	31
C. Daily Graphic Display	32
2. Using the Travel Time Mode	33
A. Switching the Display	33
B. Setting the Travel Time	33
C. Interchanging Locations Between Travel Time Mode and Time Mode	34
3. Using the Destination Timer Mode	35
A. Setting the Destination Timer	35
B. Destination Timer Measuring Procedure	36
4. Using the Alarm Mode	38
A. Alarm ON/OFF and Alarm Monitor	38
B. Setting the Alarm	38

5. Using the Chronograph Mode	40
A. Reading the Display	40
B. Chronograph Timing Procedure	40
6. Using the Timer Mode	41
A. Setting the Timer	41
B. Timer Measuring Procedure	42
7. Using the System Monitor Mode	43
A. Switching the Display	43
B. Charge Level Indicator	43
C. Flash Memory Status Display	44
D. Garbage Collection Operating Procedure	44
Locations Displayed by this Watch	46
Warning Functions	47
1. Types of Warning Functions and Conditions for Activation of Warning Functions	47
2. Explanation of Warning Functions	48
Diving Terms Used by this Watch	52
Using the Dive Plan Mode	55
1. Switching the Display	55
2. NITROX Setting	56
3. High-Altitude Setting	56
4. Dive Condition Marks	57
5. Switching Dive Condition and Setting Oxygen Concentration (O ₂ %)	57
A. NITROX Setting and Oxygen Concentration Setting	57
B. Switching from NITROX Setting to AIR Setting	57
6. Calling Up No-Decompression Limit Time	58
7. Dive Alarm	58
A. Setting the Dive Alarm	59
B. Dive Alarm Monitor	59

Using the Scuba Diving Log Mode and Skin Diving Log Mode	60
1. Calling Up Scuba Diving Log Data	60
2. Calling Up Skin Diving Log Data	61
3. Deleting Log Data	62
Using the Dive Mode	63
1. Explanation of Display During Water Depth Measurement	64
A. Display during AIR Setting	64
B. Display during NITROX Setting	65
2. Safety Stop Graph and Decompression Stop Graph	66
A. Safety Stop Graph Display	66
B. Decompression Stop Graph	66
3. Depth Measurement	66
4. Dive Time Measurement	67
5. Water Temperature Measurement	67
6. No. of Dives Per Day and Recording Log Data	67
7. Ending the Dive Mode	67
Using the Surface Mode	68
Low power mode (Temporary function)	69
1. Switching the Display	69
2. Setting the Time and Date	70
Data Communication Functions	71
1. Infrared Communication	71
A. Communication Range	71
B. Infrared Communication Mode Operating Procedure	72
2. Communication by USB Interface	73
3. Data Communication with PC	73
A. Preparations for Communication	74
B. Sending and Receiving Data	75
4. Data Communication Between Watches	75
All Reset	77
Formatting Flash Memory	78

Accessory Software	79
1. Operating Environment	79
2. Installing AQUALAND GRAPH Nx (Diving Data Management Software)	80
3. Installing CAPgm (Watch Setting Software)	81
4. Startup and Ending AQUALAND GRAPH Nx and CAPgm	83
A. Startup of AQUALAND GRAPH Nx and CAPgm	83
B. Ending AQUALAND GRAPH Nx and CAPgm	83
Communication Unit	84
1. Names and Functions of Components	85
2. Using the Communication Unit	86
A. Installing Batteries	86
B. Attaching and Removing the Watch	86
3. Installing the USB Driver	87
Troubleshooting	93
Handling Precautions (for the watch)	97
Specifications	100
1. Watch	100
2. Charger	101
3. Communication Unit (Sold Separately)	102

Checking Accessories

After opening the package, first check that all of the following products and accessories are present.

Special-Purpose Trunk



Watch - 1 pc.



Charger - 1 pc.



CD-ROM - 1 pc.



Instruction Manual (this manual)

Size AA alkaline
batteries - 4 pcs.

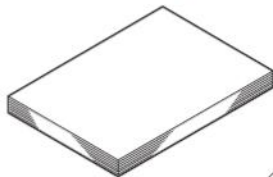
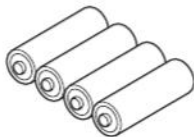

Cautions Regarding Use During Diving



WARNING

When using the watch during diving, always make sure to receive the proper diving instruction and training and use the watch while obeying all rules. Failure to observe these matters can lead to decompression sickness, oxygen toxication or other accidents involving death or serious injury.

* Please refer to these matters along with the section describing "Safety Precautions" on pp. 7-11 for further details.

- In the case of using this watch for diving, always make sure to also use other backup equipment (including a DCIEM dive table, divers watch, residual pressure gauge and water depth gauge) to ensure safety.
- Inspect the watch to make sure that all functions operate properly before diving.
- It is recommended to only use this watch for recreational diving down to a depth of about 18 m (60 ft). Do not attempt to dive below the limit depth of 40 m (131 ft) during recreational diving.
- Always make sure to allow an ample margin for no-decompression time.
- Perform adequate safety stops and decompression stops. Even in the case of no-decompression diving, always make a safety stop at 5 m (15 ft) to ensure safety. In addition, in the case the decompression stop display appears, try to stop for a period longer than that indicated on the display.
- Allow for a sufficient rest period after diving in accordance with safety rules. Boarding an airplane or moving to a high altitude without allowing for a sufficient rest period after diving results in the risk of decompression sickness.



PROHIBITED Prohibited Use During Diving

Never attempt to use this watch for diving under the following circumstances.

- When diving is prohibited in the system monitor mode:
 - ... The watch will not switch to the dive mode when [] has changed to NG.
- When the watch has stopped running or an error has occurred (be careful not to bump the watch against hard objects such as equipment or rocks when diving).
- When measuring water depth outside the guaranteed temperature range or at an altitude of 3,000 m (10,000 ft) or higher
 - ... The temperature range for which the water depth measurement accuracy of this watch is guaranteed is from +10°C to +40°C (50°F to 104°F).
 - ... The water depth measurement function does not operate at high altitudes equivalent to 3,000 m (10,000 ft) above sea level or higher.
- When engaged in dangerous behavior or when a situation is judged to be dangerous:
 - ... This watch is not built to function as a preventive or emergency instrument such as for use during marine accidents.
- When using in a helium gas atmosphere (saturation diving, etc.):
 - ... Use under these conditions can cause a malfunction or damage to the watch.

Cautions Regarding Use During Diving

Please make sure to observe the following matters before, during and after diving.



WARNING Cautions Before Diving

- Sufficiently charge the watch and confirm that the watch is reliably charged and that the watch can be used for diving by referring to the system monitor mode. If the watch is not sufficiently charged, the watch will not switch to the dive mode even if diving is started. In addition, try to start a dive after first sufficiently charging the watch before diving to avoid having the watch become insufficiently charged while diving.
- During NITROX diving, check that the oxygen concentration (O₂%) is correctly set to the oxygen concentration of the tank actually used before each dive. Diving with the oxygen concentration set incorrectly may cause incorrect information to be displayed during diving, greatly increasing the risk of decompression sickness and oxygen toxication. The oxygen concentration (O₂%) cannot be set or changed while in the water and after a dive has been started. Always make sure to check and set the oxygen concentration prior to diving.
- Check whether “ERR (Error)”, “CHK (Check)” or “CHRG (Charge)” is displayed on the display. The watch will not switch to the dive mode when “ERR” or “CHK” are displayed. If “CHRG (Charge)” is displayed, since this indicates that the watch is not fully charged, the watch may become insufficiently charged while diving.
- Confirm that the band is securely attached to the watch body.
- Confirm that the band and glass are free of cracks, scratches, chips and other abnormalities.
- Confirm that the time and date are set correctly.
- Confirm that the depth alarm and dive time alarm are set correctly.
- When there is a large difference between the temperature of the watch and the water temperature, immerse the watch in the water for at least 5 minutes to acclimate the temperature of the watch to the water temperature and then remove it from the water before diving. A large difference between the watch temperature and water temperature (such as in the case of placing the watch in water having after allowed it to sit in direct sunlight) can prevent water depth from being measured accurately.



WARNING Cautions During Diving

- Avoid ascending too rapidly. A rapid ascent can cause decompression sickness and have other detrimental effects on the body. Observe the safe ascent rate at all times.
- Please note that when underwater, it may be difficult to hear the sound of the dive alarm or other alarms depending on surrounding conditions (such as breathing noise and air bubble noise) and the manner in which the watch is worn.
- Be careful not to run out of air. This watch does not manage the amount of air remaining in the air tank. The diver is responsible for managing the amount of air remaining.
- In the event the watch should happen not to operate properly while underwater, either ascend immediately while following the instructions of the instructor or begin ascending immediately at an ascent rate of no more than 18 m (60 ft) per minute and make a safety stop at 5 m (15 ft) as long as your air lasts.



WARNING Cautions After Diving

- Make sure to rest sufficiently after diving by referring to the surface mode (which measures the amount of time elapsed after diving and no fly time).
- After removing any moisture, mud, sand or other foreign matter adhered to the watch by thoroughly rinsing with fresh water, completely wipe off the watch with a dry cloth.
- Do not attempt to remove the sensor cover or poke at it with a sharp object to attempt to remove any dirt or debris trapped in the pressure sensor. In addition, do not spray the pressure sensor with air under high pressure such as that from an air gun. In the case that debris has become trapped in the pressure sensor, rinse it out with fresh water. If it is still unable to be removed, consult your nearest Citizen Service Center.



CAUTION Diving in Fresh Water

- Although this watch is compatible with high-altitude diving, since it is ultimately designed on the premise of diving in seawater, it does not display the correct water depth if used in water other than seawater.
- Only use this watch for diving in fresh water after having received special safety training. Since this watch displays water depth by converting on the basis of seawater (specific gravity: 1.025), the water depth is actually 2.5% deeper than the displayed depth.

Example: Displayed water depth of 20 m \times 1.025 = 20.5 m (actual water depth)
(66 ft \times 1.025 = 68 ft)

- * Although an error occurs in the displayed water depth during freshwater diving at high altitudes and so forth, the calculations of the dive computer are performed correctly.

Features

This watch is provided with numerous convenient functions used during diving.

- Various information is displayed to serve as a reference for safe diving by calculating residual body nitrogen based on depth during diving, dive time and previous dive history, etc. (Dive Computer Function).

* Decompression Calculation Algorithm

This watch employs the calculation formula of the Canadian Defense and Civil Institute of Environmental Medicine (DCIEM).

- This watch is compatible with NITROX diving (NITROX: mixed gas having an oxygen concentration that differs from compressed air used in ordinary diving) and high-altitude diving.
 - The oxygen concentration (O₂%) of the mixed gas can be set within the range of 22% to 50%.
 - Since the pressure sensor periodically measures air pressure even when on land and calculates the body's nitrogen level each time, decompression calculations are performed corresponding to altitude based on actual air pressure prior to diving during high-altitude diving as well.
- Measurement of water depth begins automatically simply by placing the watch on your wrist and entering the water, and various data (depth, elapsed time, etc.) are measured automatically while diving.
- This watch distinguishes between skin diving and scuba diving according to diving conditions (depth and dive time), and a maximum of 100 sets of log data are automatically recorded for both types of diving.
- This watch is also provided with various warning functions necessary for safe diving.
- Log data and profile data (up to 2 hours) automatically recorded in the watch can be transferred to a PC by using the infrared communication interface or communication unit* 1, making it possible to easily manage and generate graphic representations of transferred data on your PC.

Various watch functions can be set on your PC.

- The following watch settings can be transferred to and edited on your PC using the infrared communication interface or communication unit* 1.
 - Addition, deletion and alteration of locations displayed in each mode by the watch.
 - Various travel time, alarm and destination timer settings.
 - Setting of dive alarm used during diving and entry of the number of previous dives.
 - Setting of daily graphics and graphics displayed on anniversaries (graphic display).

This watch is also equipped with an infrared communication function.

- The wrist watch infrared communication standard (IrWW) is used for infrared communication. This enables the time and alarm time to be set between watches using this standard.
- If a friend or acquaintance has the same watch, data can be transferred between those watches (including time, date, alarm and dive alarm settings). In addition, communication with a PC can also be performed using infrared communication.

This watch is of the rechargeable type.

- The energy storage cell used for the power source of the watch is completely free of mercury and other hazardous substances making it environmentally friendly.
- The energy storage cell of the watch is charged using the charger or communication unit*1. Once fully charged, the watch can be used continuously for about one month under standard operating conditions. (Continuous usage time varies according to the use of additional functions and other conditions of use. For further details, refer to the section on "Charge Level Indicator and Continuous Usage Time".)
- This watch is also equipped with a charge level indicator that provides a general indication of the charge level of the watch, as well as an insufficient charge warning function that informs the wearer that the watch is insufficiently charged on the display.

Other Convenient Functions

- This watch is also equipped with a travel time function that enables you to easily display local time when traveling or on business overseas, as well as a destination timer function that displays the amount of time remaining until you reach your destination.
- You can select from 15 types of preset sounds that are heard in each of the alarm, destination timer and timer modes.
- An EL illumination function is provided that makes it possible to confirm display contents even in dark locations.
- Other convenient functions offered by this watch include a 24 hour format alarm, chronograph capable of timing up to 99 hours 59 minutes 59.99 seconds in 1/100 second increments, and a timer function that can be set up to 99 minutes.

*1: The communication unit (USB interface which also serves as a charger) is sold separately.

Since this product requires special techniques and equipment for final adjustment and confirmation following completion of repairs, all repairs (excluding the watch band) must be performed at a Citizen Service Center. Please contact your nearest Citizen Service Center when requesting repairs or inspections.

Charger



CAUTION Handling of the Charger

- Do not allow water to contact the charger or allow the charger to become wet. The charger is not of water resistant construction. In addition, entrance of sand, dust or other debris inside the charger can cause a malfunction. Particular caution is required when using the charger outdoors. Make sure that the watch is not wet when placing it in the charger.
- When transporting the charger, always make sure to place it in its special-purpose trunk or place it in a bag wrapped in cloth or sponge that prevents the passage of electricity. Carrying the charger unprotected can cause generation of heat or the 4 pcs. of size AA alkaline batteries inside the charger to become worn down due to shorting between the terminals. When storing the charger at home, be careful so that the terminals of the charger are not shorted due to contact with metal.
- Use and store the charger within a temperature range of +10°C to +40°C (50°F to 104°F), and humidity range of 20% to 80% (with no condensation of moisture). Avoid storing and using in environments subject to sudden changes in temperature.
- Avoid storing and using the charger in locations subject to direct sunlight or high levels of sand and dust. Do not allow the charger to remain inside an automobile in particular.
- Do not attempt to disassemble or modify the charger. This can cause a malfunction.
- Do not connect the charger to other brands of watches or other models of Citizen watches. This charger is to be used exclusively with CYBER AQUALAND Nx (Movement No. D71*).
- Do not drop the charger or subject it to strong shocks. This can cause the risk of cracking and malfunction.
- Please be aware that the manufacturer is not responsible for any damage, lost revenues or demands for compensation from a third party that occur as a result of the use of this product.
- Please be aware that the manufacturer is not responsible for any damage, lost revenues or demands for compensation from a third party attributable to repair or malfunction of this product.

1. Names and Functions of Components

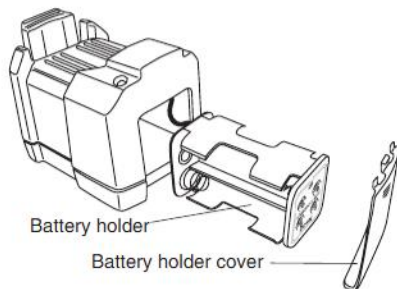
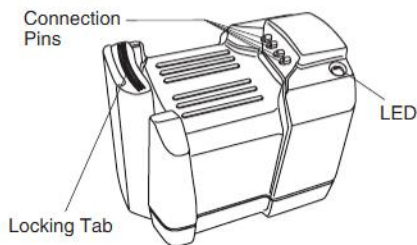

LED (Light Emitting Diode)

The LED lights during charging. When the watch is placed in the charger, the LED lights to indicate that charging has started. The LED goes out when charging is completed.

Connection Pins

There are four connection pins. The two center pins are contacted with the charging terminal and water sensor of the watch, while the two outside pins are contacted with the watch case.

Locking Tab

This is used to clamp the watch to the connection pins and lock it in position.

Battery Holder (inside of the charger)

The battery holder holds 4 pcs. of size AA alkaline batteries. The battery holder is connected to the charger with a cable.

Battery Holder Cover

This battery holder cover is opened when installing or replacing the 4 pcs. of size AA alkaline batteries to install or remove the 4 pcs. of size AA alkaline batteries.

2. 4 pcs. of size AA Alkaline Batteries Installation Procedure



CAUTION Handling of Size AA Alkaline Batteries

Since improper use of the batteries can result in the risk of leakage of battery fluid or rupture, use particular caution with respect to the following items.

- Install the size AA alkaline batteries with the polarity (+,-) correctly aligned.
- Use same types of size AA alkaline batteries installed in the charger.
- Do not use fresh size AA alkaline batteries with old ones. When replacing the size AA alkaline batteries, replace all of the size AA alkaline batteries with 4 pcs. of fresh size AA alkaline batteries of the same type.

- (1) Open the battery holder cover on the side of the charger. The battery holder cover can be opened by sliding in the direction of the arrow while pressing lightly on the battery holder cover.

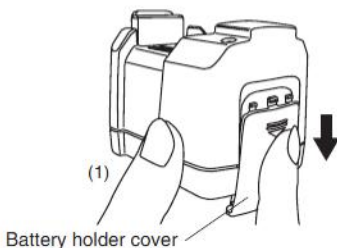

- (2) Pull out the battery holder from the charger.

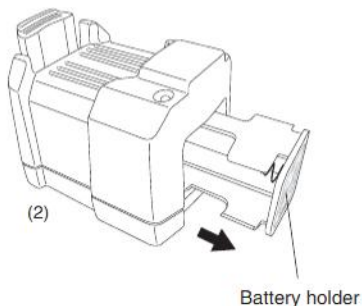

(3) Place 4 pcs. of size AA alkaline batteries in the battery holder aligned in the proper manner by referring to the illustration seal on the front of the battery holder.

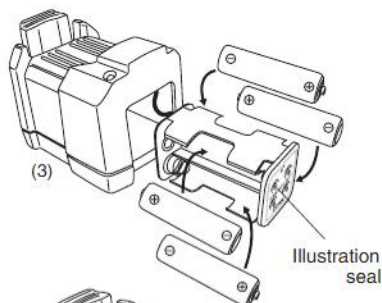

(4) Place the battery holder in the charger with the front of the battery holder (side with the illustration) facing towards you.

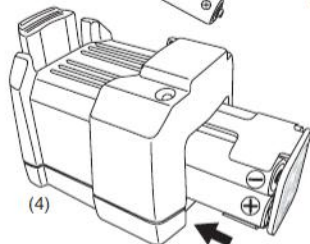

(5) Securely close the battery holder cover.

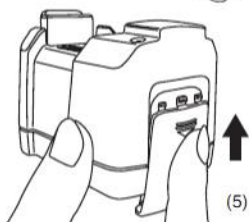

- * Do not pull on the battery holder with excessive force when pulling out the battery holder from the charger or installing the battery holder in the charger. Subjecting the connection cable connecting the charger and battery holder can cause a poor connection.
- * Close the battery holder cover tightly. Be careful not to lose the battery holder cover when removing it.
- * Be careful not to damage the tab when removing the battery holder cover.
- * 4 pcs. of size AA alkaline batteries in the charger will continue to wear down, although very slowly, even when they are not being charged. It is recommended to remove 4 pcs. of size AA alkaline batteries from the charger if they are not to be charged for a long period of time.

3. Charging the Watch

We advise recharging to be done at stable flat surface to avoid unexpected disengagement of the watch.

(1) Sufficiently open up the locking tab on the left side of the charger.

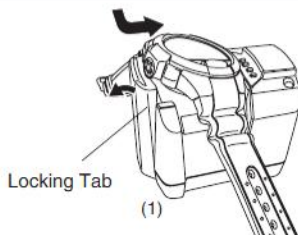

- (2) Attach the watch to the charger so that the two center connection pins of the four connection pins on the right side of the charger make contact with the two terminals (gold) at the 3:00 position on the watch.

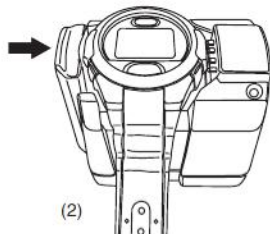

- * If the watch display is not showing before charging, simultaneously press the lower right button (A), upper right button (B), upper left button (C) and lower left button (D) and then release with the watch attached to the charger to perform the all reset procedure. (Refer to the section on "All Reset" for information on the all reset procedure.)
- (3) Charging will begin if the watch is properly connected to the charger. The LED on the top of the charger lights when charging begins, and goes out when charging is completed (when the watch is fully charged).
- (4) Sufficiently open the locking tab of the charger and remove the watch from the charger.

- * Approximately 7 hours is required for charging when the energy storage cell of the watch is completely discharged.
- * Try to recharge the watch before the energy storage cell of the watch becomes completely discharged. There is no risk of overcharging no matter how long the watch is connected to the charger.
- * When the LED does not light and the charge level indicator of the watch does not indicate that the watch is fully charged even if the watch has been attached to the charger, the 4 pcs. of size AA alkaline batteries of the charger are worn out. Replace all 4 pcs. of size AA alkaline batteries with fresh size AA alkaline batteries and repeat charging.
- * Attempting to attach or remove the watch without opening the locking tab sufficiently may cause the connection pins to become worn or damaged resulting in malfunction of the charger. However, please note that opening the locking tab beyond what is necessary can damage the locking tab.
- * This charger has been designed for use with CYBER AQUALAND Nx equipped with an original urethane band. Please note that if this charger should happened to be used with a different band other than the original urethane band or the urethane band is replaced with a metal band, the contacts of the watch and charger may become unstable, thereby preventing the watch from being charged properly.

Watch Display During Charging

Once charging begins, the watch automatically switches to the system monitor mode (charge level indicator) after the  mark in the lower left section of the watch display flashes. ("CHRG" is displayed in the lower left section of the display.)



- * When the watch has been charged to a certain extent (when all the sections of the charge level indicator are lit), although the diver mark remains flashing without the watch switching to the system monitor mode, charging is still performed correctly even in this state.
- * Although "CHK" may flash in the lower left section of the display during charging, charging is performed correctly in this case as well. "CHK" is no longer displayed and the display returns to normal when the watch is removed from the charger after charging is completed.

Names of Components

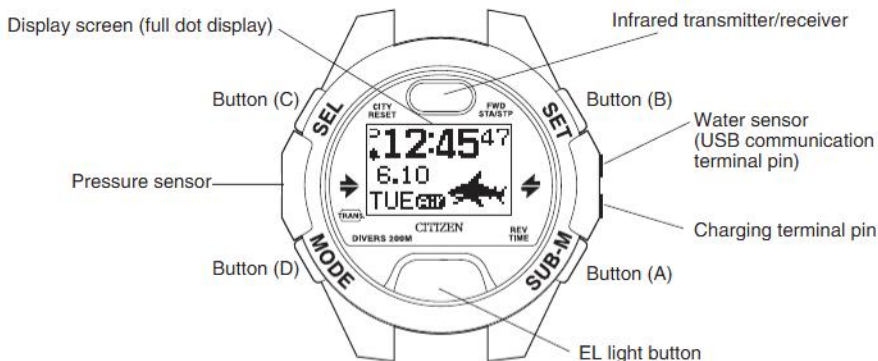

Watch Display Modes (Functions)

Standard Mode

The watch is usually used in this mode. The standard mode consists of the following seven modes.

1. Time Mode

In this mode, the watch displays the time and date (main time) that are the basic parameters of this watch. This mode is normally displayed when wearing the watch.

2. Travel Time Mode **TRV**

In this mode, the watch displays the time and date for a different location from the time mode.

3. Destination Timer Mode **DST**

In this mode, the watch displays the time remaining until a preset arrival time in 1 second units after a destination and arrival time have been preset. This convenient function can be used when traveling or on business overseas.

* Maximum measuring range: 99 hours 59 minutes 59 seconds

4. Alarm Mode **ALM**

In this mode, the watch displays the preset alarm time.

5. Chronograph Mode **CHR**

In this mode, the watch measures time with a chronograph up to 99 hours, 59 minutes 59.99 seconds in 1/100-second units.

6. Timer Mode **TMR**

In this mode, the watch measures time with a count down timer in 1 second units (and can be set up to 99 minutes in 1 minute units).

7. System Monitor Mode **BATT / FILE**

In this mode, the watch displays the charge level of the watch along with a general indication of the usage status of flash memory.

Dive Plan Mode

This mode is used to set the plan for the next dive. It can be used to change the AIR or NITROX settings and set the oxygen concentration (O₂%) for the next dive, display the no-decompression limit time and set the dive alarms used during diving.

Scuba Diving Log Mode

This mode is used to confirm the logs of previous scuba diving. In this mode, the watch displays various data (logs) for scuba diving automatically recorded while diving.

Skin Diving Log Mode

This mode is used to confirm the logs of previous skin diving. In this mode, the watch displays various data (logs) for skin diving automatically recorded while diving.

Dive Mode

This mode is used for diving. The watch automatically switches to the dive mode when a dive is started, and displays current water depth, dive time and other data required while diving during the course of a dive.

Surface Mode

In this mode, the watch displays the elapsed time since completion of the most recent scuba dive and the amount of time flying in an aircraft is prohibited (maximum 24 hours) (no fly time). The surface mode is no longer displayed once the no fly time has elapsed.

Infrared Communication Mode

This mode is for communicating with a PC or communicating between watches using the infrared communication function.

Low power mode (Temporary function)

The low power mode is a temporary function for powering the watch with the minimum amount of current consumption. The watch automatically switches to the low power mode when it has become insufficiently charged.

Do not wear the watch in the low power mode during daily use. Although the watch can be manually switched to this mode by operating the buttons, all functions except for time and date display and correction do not operate. In addition, the watch cannot be switched from the low power mode to the dive mode.

Charge Level Indicator and Continuous Usage Time

An approximate indication of the amount of charge remaining in the watch can be confirmed on the display. The charge level indicator can be displayed in either the time mode of the standard mode (location display) or the system monitor mode.

1. How to Read the Charge Level Indicator of the watch

The charge level indicator changes in the manner shown below according to the amount of elapsed time the watch has been used.

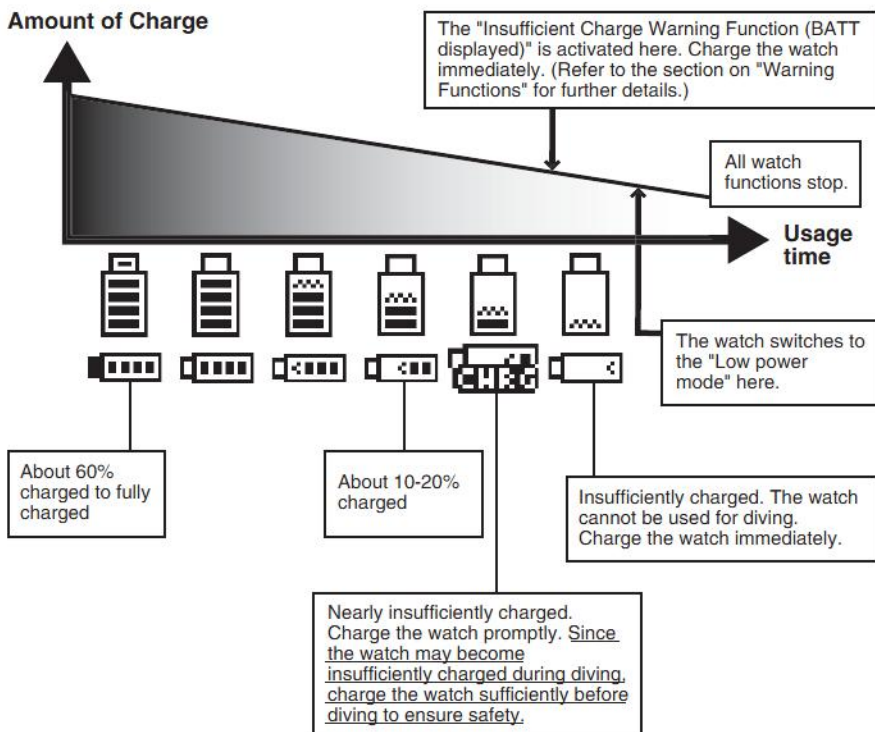

* The above illustration provides a graphic representation of the amount of residual charge in the watch and the changes in the charge level indicator.

2. Continuous Usage Time

This watch will continue to run for about 1 month (until the insufficient charge warning function is activated) once it has been fully charged.

This is roughly based on the conditions of use indicated below.

- Diving (water depth measurement): Twice/week (30 min./dive)
- Alarm: 30 seconds/day
- Chronograph measurement: 1 hour/week
- EL light: 4 seconds/day

- * The continuous usage time of the watch becomes shorter the more often the alarm, chronograph and other functions are used. In addition, the continuous usage time is further reduced by infrared communication.
- * Since the water sensor is activated when the watch gets wet even when not diving, the continuous usage time becomes correspondingly shorter.

Using the EL Light

The EL light is illuminated for about 1 second when the EL light button on the front of the watch is pressed in any of the modes except for the infrared communication mode. The EL light is illuminated for about 5 seconds when the EL light button is pressed continuously.

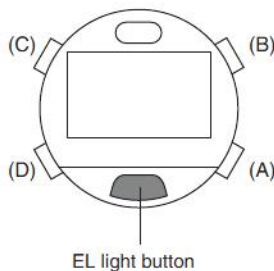

CAUTION

The EL light is designed to enhance daylight viewing. At night an external light source may be required to view the display.

Switching the Mode

- The mode of the standard mode changes in the order of time, travel time, destination timer, alarm, chronograph, timer and system monitor each time the lower right button (A) is pressed in the standard mode.
- The mode changes in the order of standard mode, dive plan mode, scuba diving log mode and surface mode each time the lower left button (D) is pressed.
- The watch automatically switches to the dive mode (preliminary dive display) when the water sensor gets wet in any mode (excluding the infrared communication mode and low power mode).
- The watch switches to the infrared communication mode (initial display) when the lower left button (D) is pressed for at least 2 seconds and then released in any mode (excluding the dive mode and low power mode).

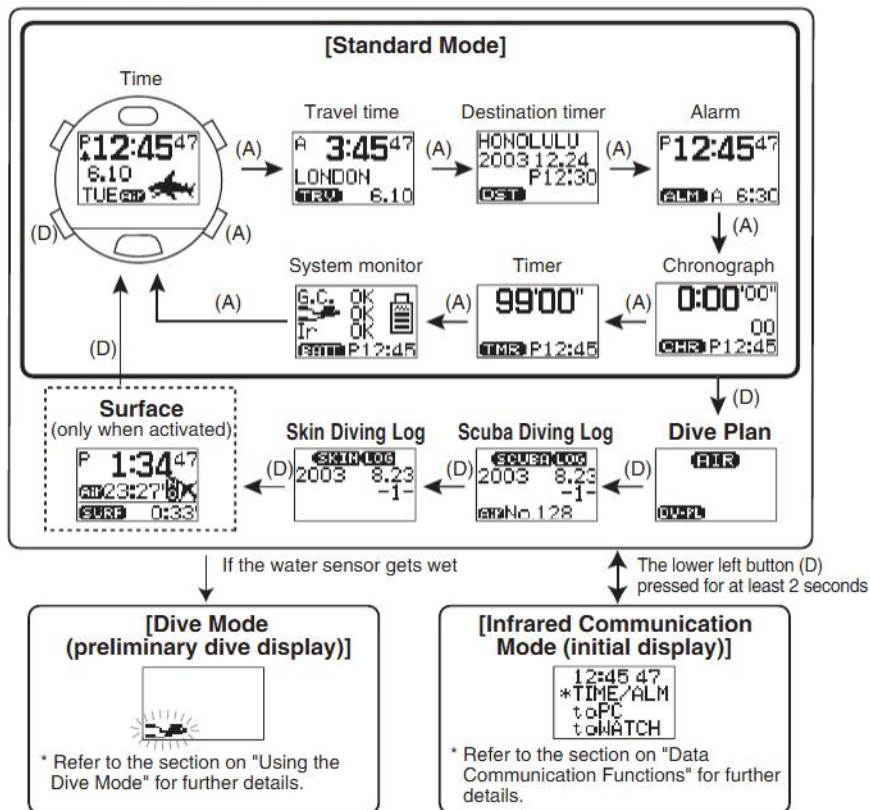

- * The surface mode is no longer displayed once measurement of no fly time (timer) is completed after scuba diving. The watch switches to the time mode of the standard mode when the lower left button (D) is pressed in the skin diving log mode when the surface mode is not activated.
- * When none of the buttons are pressed for about 3 minutes in any of the modes of the standard mode, dive plan mode, scuba diving log mode or skin diving log mode, the watch automatically returns to the time mode of the standard mode (except that it returns to the surface mode when the surface mode has been activated).
- * The watch switches to the low power mode when the lower right button (A) and lower left button (D) are pressed for at least 2 seconds and then released in the time mode of the standard mode.
- * If "BATT", "ERR" or "CHK" is flashing in the lower left section of the display in any of the modes (indicating that a warning function has been activated), and during correction in any mode, the watch does not switch to the dive mode even if the water sensor gets wet.
- * The hourglass mark or "LOADING" are displayed when switching to and from the dive mode, infrared communication mode or low power mode. The water sensor along with all button operations do not function while these are displayed.

Using the Standard Mode

1. Using the Time Mode

This mode is the basic mode of this watch that displays the time and date.

A. Switching the Display

- The display switches between the Day Display and Location Display each time the upper left button (C) is pressed once.
- When the upper right button (B) is pressed once when either the Day Display or Location Display is displayed, the display changes to the Enlarged Display. Pressing the upper right button (B) again returns it to the original display.

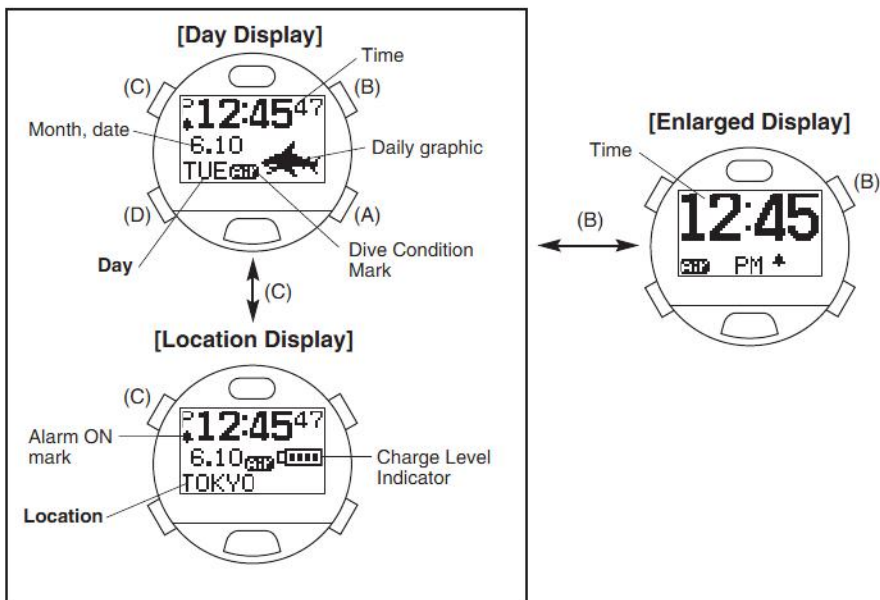

* When the charge of the watch becomes low (when the charge level indicator indicates ) , the "Day Display" or "Enlarged Display" automatically change to the "Location Display" after about 3 minutes to indicate that the watch should be charged.

B. Setting the Time and Date

- (1) The watch enters the correction state (display is flashing) when the upper left button (C) is pressed for at least 2 seconds and then released during any display of the time mode.



- (2) The location on the display that is flashing changes in the order shown below each time the upper left button (C) is pressed once.

- The watch returns to the normal display when the upper left button (C) is pressed and then released in the contrast correction state.

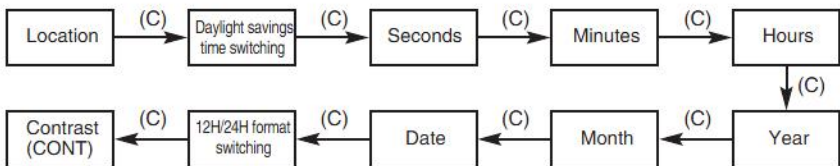

- (3) Correct the flashing item by pressing either the upper right button (B) or lower right button (A).

- Pressing the upper right button (B) advances the display by one step at a time each time it is pressed, while pressing the lower right button (A) moves the display back by one step at a time each time it is pressed. (Pressing either button continuously causes the display to change rapidly.)
- Refer to the section on "Locations Displayed by this Watch" for information on displayed locations.
- The watch returns to 00 seconds when the upper right button (B) or lower right button (A) is pressed. (If the seconds are between 30 and 59 seconds at that time the minutes advance by 1.)
- When the display is set to switching daylight savings time (ON or OFF is flashing) or switching the 12H/24H format, the display switches back and forth between the settings each time the lower right button (A) or upper right button (B) is pressed.

- (4) Pressing and then releasing the lower left button (D) returns the watch to the normal display.

- The year can be set from 2000 to 2099. However, January 1, 2000 is designated as a special date for use by the hardware system of this watch. If the watch is attempted to be used for infrared or USB communication or is switched to the low power mode while set to this date, all the display elements on the watch are displayed and the watch returns to the initial setting (12:00 AM, January 1, 2003). Please do not set your watch to January 1, 2000.
- Once the date has been set, it is not necessary to correct for leap years or the end of the month. (Dates such as February 30 that do not actually exist are not displayed even during correction.)
- Pay attention to AM (A) and PM (P) when using the 12 hour format.
- When daylight savings time has been set (ON), the time advances by 1 hour from the current time and "ST" appears on the display. Daylight savings time cannot be set for Coordinated Universal Time (UTC).
- The day is corrected automatically by correcting the year, month and date.
- The watch automatically returns to the normal display when none of the buttons are pressed for about 3 minutes in the correction state (display flashing).
- The watch can be immediately returned to the normal display by pressing the lower left button (D) and then releasing in the correction state (display flashing).

C. Daily Graphic Display

A single daily graphic is pre-registered in your watch at the time of purchase. Images displayed for the daily graphic can be changed, added or deleted by using the “CAPgm” software provided. Images registered for the daily graphic are displayed in order each day in the lower right corner of the “Day Display”. In addition, on those days that have been set as anniversaries, the daily graphic registered for that anniversary is displayed.

Please refer to the “CAPgm” manual contained in the CD-ROM for further details regarding the procedures for setting and displaying daily graphics.



Daily graphic

2. Using the Travel Time Mode

The travel time mode is used to display the date and time of another location separate from the Main Time of the time mode (Main time). Simply select a location desired to be displayed in the travel time mode from the pre-registered locations to automatically display the time and date for that location as determined by converting the time difference. In addition, the location displayed in the travel time mode and the location displayed in the time mode can be easily interchanged.

A. Switching the Display

The time difference from the Coordinated Universal Time (UTC) along with the time difference from the time in the time mode are displayed for as long as the upper right button (B) is pressed in the travel time mode.

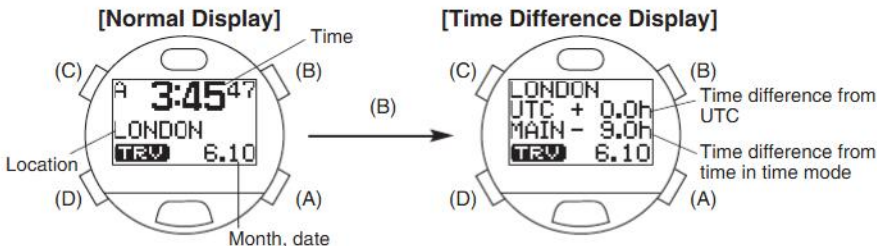

B. Setting the Travel Time

- (1) The location flashes when the upper left button (C) is pressed for at least 2 seconds and then released in the travel time mode.
- (2) The location is changed by pressing the upper right button (B) or lower right button (A).
 - Pressing the upper right button (B) once calls up the next location each time it is pressed, while pressing the lower right button (A) once calls up the next location in the reverse order each time it is pressed. (Pressing either button continuously enables the location to be changed rapidly.)
 - Refer to the section on "Locations Displayed by this Watch" for information on displayed locations.
- (3) The setting for daylight savings time (ST ON (set) or ST OFF (canceled)) flashes when the upper left button (C) is pressed once.
- (4) Daylight savings time is corrected by pressing the upper right button (B) or lower right button (A).
 - The display switches back and forth between the settings each time the lower right button (A) or upper right button (B) is pressed once.
- (5) Pressing the lower left button (D) and then releasing returns the watch to the normal display.



- * The 12 hour or 24 hour format is used in accordance with the setting in the time mode.
- * Daylight savings time cannot be set for Coordinated Universal Time (UTC).
- * In the case the setting for daylight savings time is changed when the location in the travel time mode is the same as the location in the time mode, the setting for daylight savings time is applied to the time mode as well.
- * The watch automatically returns to the normal display of the travel time mode when none of the buttons are pressed for about 3 minutes in the correction state (display flashing).
- * The watch can be immediately returned to the normal display of the travel location mode by pressing the lower left button (D) and then releasing in the correction state (display flashing).
- * The watch automatically returns to the time mode when none of the buttons are pressed for about 3 minutes in the travel time mode.

C. Interchanging Locations Between Travel Time Mode and Time Mode

When a location in a time zone that is frequently used is set in the travel time mode, and this interchanging procedure is performed after having arrived at that location, the time and date of the location displayed in the travel time mode can be displayed in the time mode. As a result, the time and date of the location that had been displayed in the time mode is now displayed in the travel time mode.

<Procedure>

Press the upper right button (B) and upper left button (C) simultaneously for at least 2 seconds and then release in the travel time mode. The location in the time mode and location in the travel time mode are interchanged and the watch switches to the time mode.

Example: Location set in time mode (main time): TOKYO

Location set in travel time mode: LONDON

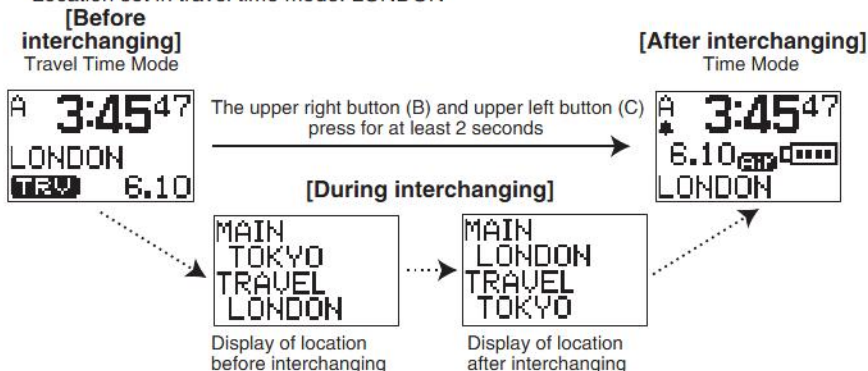

3. Using the Destination Timer Mode

The destination timer measures and displays the amount of time remaining until arriving at a destination up to a maximum of 99 hours, 59 minutes and 59 seconds after having set the destination and arrival time when traveling or on business overseas. Once the arrival time is reached, an alarm informing you of arrival sounds for about 30 seconds and "Dest" is displayed on the display. After arrival, elapsed time from the time of arrival is measured for up to 99 hours, 59 minutes and 59 seconds.

In addition, the alarm informing you of arrival at your destination can be selected from 15 types of alarm sounds.

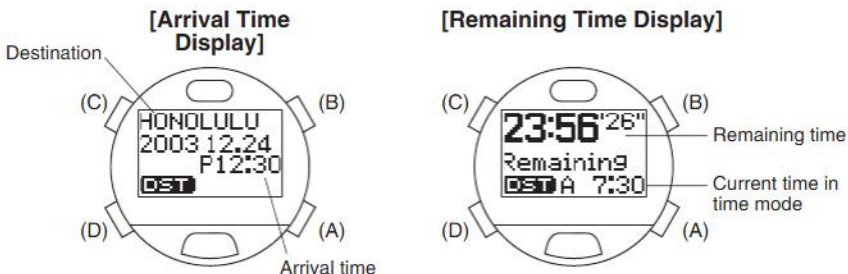

A. Setting the Destination Timer

- (1) The watch switches to the correction state (display flashes) when the upper left button (C) is pressed for at least 2 seconds and then released in the destination timer mode.
- (2) The flashing item changes in the order shown below each time the upper left button (C) is pressed once.
 - Pressing the upper left button (C) and then releasing in the alarm number correction state returns the watch to the normal display.

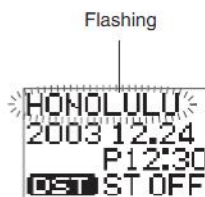
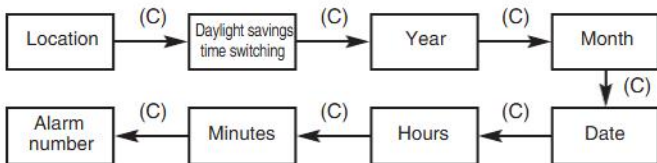

- (3) The flashing item can be corrected by pressing either the upper right button (B) or lower right button (A).
 - Pressing the upper right button (B) advances the display by one step at a time each time it is pressed, while pressing the lower right button (A) moves the display back by one step at a time each time it is pressed. (Pressing either button continuously causes the display to change rapidly.)
 - Refer to the section on "Locations Displayed by this Watch" for information on displayed locations.
 - When switching daylight savings time (ON or OFF is flashing), the display switches back and forth between the settings each time the lower right button (A) or upper right button (B) is pressed once.

- When the upper right button (B) is pressed once while in the alarm number selection state (an alarm number is flashing), the next alarm number is called up each time it is pressed. When the lower right button (A) is pressed once in the alarm number selection state, the next alarm number is called up in the reverse order each time it is pressed. Select "Silent" when you do not want the alarm to sound.
 - You can monitor the alarm corresponding to the flashing alarm number by pressing the upper right button (B) or lower right button (A) in the alarm number selection state for as long as the button is pressed. (The next or previous alarm number is momentarily displayed the instant the button is pressed, while pressing either button continuously causes the set alarm to sound.)
- (4) Pressing the lower left button (D) and then releasing finalizes the setting after which the destination timer starts to run and the remaining time until the arrival time is displayed.

- * The 12 hour or 24 hour format setting is in accordance with the setting in the time mode.
- * In the case the remaining time until the set arrival time exceeds 100 hours, the destination timer stops at the arrival time display and then starts running automatically when the remaining time until the arrival time is within 99 hours, 59 minutes and 59 seconds.
- * When the arrival time has been set going back more than 100 hours, the destination timer stops at the arrival time display.
- * In the case of correcting the arrival time while the destination timer is running, the destination timer starts running according to the newly set arrival time.
- * The remaining time is recalculated in the case the time or daylight savings time setting is corrected for the location set with the destination timer in the time mode or travel time mode while the destination timer is running.
- * The watch automatically returns to the arrival time display or remaining time display when none of the buttons are pressed for about 3 minutes in the correction state (display flashing).
- * The watch can be immediately returned to the arrival time display or remaining time display by pressing the lower left button (D) and then releasing in the correction state (display flashing).

B. Destination Timer Measuring Procedure

Once the destination timer has been set, measurement begins automatically. Once the timer reaches the arrival time, an alarm sounds for about 30 seconds informing you that the time is up. After the time on the destination timer is up, elapsed time from the arrival time flashes on the display for up to 99 hours, 59 minutes and 59 seconds. After this time has elapsed, the watch returns to the arrival time display.

- * The alarm that sounds when the arrival time is reached can be turned off by pressing any button.
- * If the alarm to inform of arrival is set to "Silent", arrival time is notified only with the "Dest" display on the display.

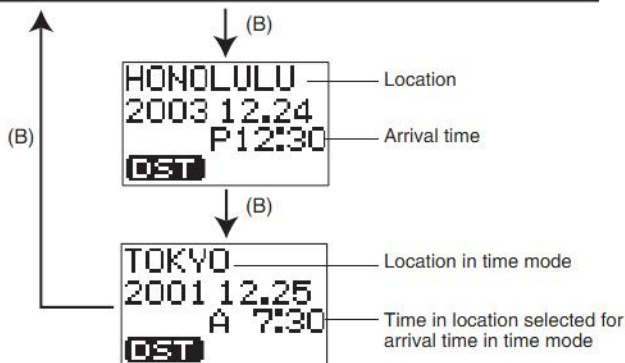
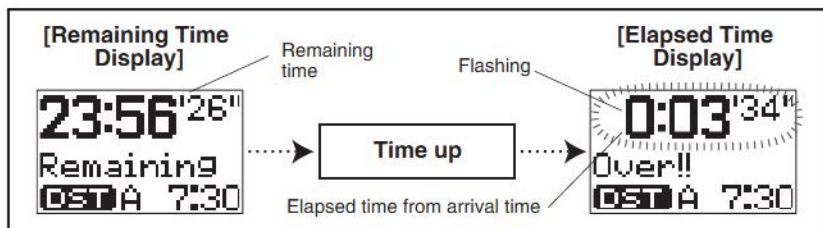

<Displaying Arrival Time Set during Measurement>

- (1) When the upper right button (B) is pressed once while the destination timer is running, the set arrival time (destination location and time) is displayed.
- (2) When the upper right button (B) is pressed once again while the arrival time is displayed, the time and location of the location selected in the time mode for the set arrival time are displayed.
- (3) Pressing the upper right button (B) once again returns the watch to the remaining time display.

- * The watch automatically returns to the remaining time display when none of the buttons are pressed for about 3 minutes during the arrival time confirmation displays described in steps (1) and (2) above.
- * The watch automatically returns to the time mode when none of the buttons are pressed for about 3 minutes in the destination timer mode (including when the destination timer is running).

4. Using the Alarm Mode

Once this alarm is set (ON), the alarm sounds for approximately 30 seconds at the same time every day and "Alarm" is displayed on the display. The alarm can be turned off by pressing any button when it is sounding. In addition, the alarm tone can be selected from 15 types of alarm sounds when setting the alarm.

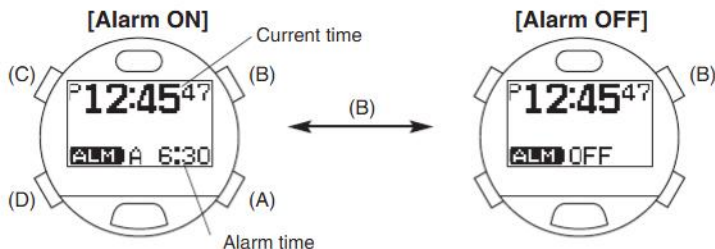

A. Alarm ON/OFF and Alarm Monitor

The alarm is switched between ON (set) and OFF (canceled) each time the upper right button (B) is pressed once in the alarm mode. Once the alarm has been set, the alarm ON mark  is displayed in the time mode. When the upper right button (B) is pressed continuously in the alarm mode, you can monitor the selected alarm tone for as long as the upper right button (B) is pressed.

B. Setting the Alarm

- (1) The watch switches to the correction state (display flashes) when the upper left button (C) is pressed for at least 2 seconds and then released during then the normal display in the alarm mode. The flashing item can be corrected.
- (2) The flashing item changes in the order shown below each time the upper left button (C) is pressed once.
 - Pressing the upper left button (C) and then releasing in the alarm number correction state returns the watch to the normal display.



(3) The flashing item can be corrected by pressing either the upper right button (B) or lower right button (A).

- Pressing the upper right button (B) once advances the display by one step at a time each time it is pressed, while pressing the lower right button (A) once moves the display back by one step at a time each time it is pressed. (Pressing either button continuously causes the display to change rapidly.)
- When the upper right button (B) is pressed once while in the alarm number selection state (an alarm number is flashing), the next alarm number is called up each time it is pressed. When the lower right button (A) is pressed once in the alarm number selection state, the next alarm number is called up in the reverse order each time it is pressed. Select "Silent" when you do not want the alarm to sound. In this case, the alarm time is notified only with "Alarm" on the display.
- You can monitor the alarm corresponding to the flashing alarm number by pressing the upper right button (B) or lower right button (A) in the alarm number selection state for as long as the button is pressed. (The next or previous alarm number is momentarily displayed the instant the button is pressed, while pressing either button continuously causes the set alarm to sound.)

(4) Press and release the lower left button (D) to finalize the alarm setting.

- * The 12 hour or 24 hour format setting is in accordance with the setting in the time mode.
- * The watch automatically returns to the normal alarm display when none of the buttons are pressed for about 3 minutes in the correction state (display flashing).
- * The watch can be immediately returned to the normal alarm display by pressing the lower left button (D) and then releasing in the correction state (display flashing).
- * The watch automatically returns to the time mode when none of the buttons are pressed for about 3 minutes during the normal alarm display.

5. Using the Chronograph Mode

The chronograph function of this watch is able to measure time in 1/100-second units for up to 99 hours, 59 minutes and 59.99 seconds. The chronograph returns to the reset display (0:00'00"00) and stops after 100 hours have elapsed.

A. Reading the Display

[Chronograph Reset Display]

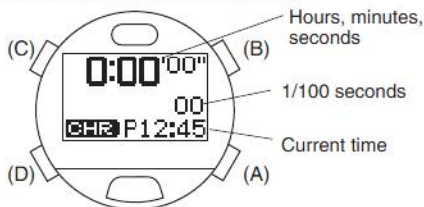

<1/100 Second Display>

The digits for 1/100 seconds of the chronograph are only displayed for 1 minute when the chronograph is started and after returning to the measurement display from the split time display, after which they are no longer displayed. However, the 1/100 second digits are also displayed when the chronograph is stopped and during the split time display.

B. Chronograph Timing Procedure

- (1) The chronograph is repeatedly started and stopped each time the upper right button (B) is pressed once.
- (2) The split time is displayed for about 10 seconds when the upper left button (C) is pressed once during measurement. The most recent split time is measured and displayed each time the upper left button (C) is pressed once. ("SPL" flashes while split time is displayed.)
- (3) Pressing the upper left button (C) while the chronograph is stopped returns the watch to the reset display.

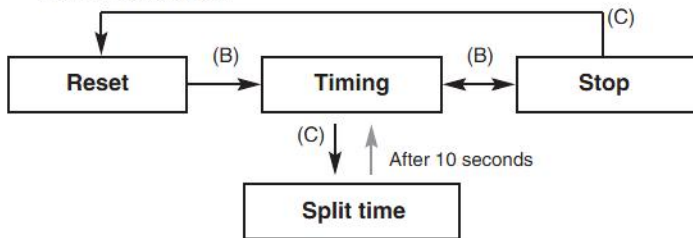

- * Split time refers to the amount of time that has elapsed from the starting line to some intermediate point.
- * The watch automatically returns to the time mode when none of the buttons are pressed for about 3 minutes during the chronograph reset display.
- * The watch automatically returns to the surface mode when none of the buttons are pressed for about 3 minutes in the chronograph mode (including during timing) when the surface mode has been activated (while resting on the surface).
- * If the mode is switched to the low power mode during chronograph timing, chronograph timing is interrupted and the watch returns to the reset display.

6. Using the Timer Mode

The timer of this watch can be set up to 99 minutes in 1 minute units. An alarm sound indicating that the time is up sounds for about 30 seconds and "Timer" is displayed on the display when the time on the timer is up. The timer then returns to the initial set time and stops.

In addition, the alarm sound indicating that time is up following completion of timing can be selected from 15 types of alarm sounds.

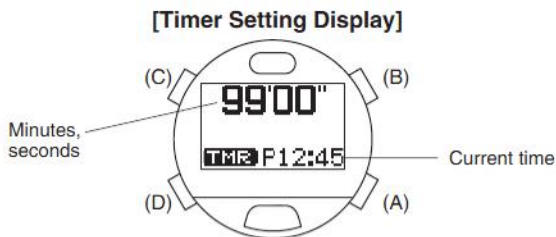

A. Setting the Timer

- (1) The minutes flash when the upper left button (C) is pressed for at least 2 seconds and then released in the timer mode.
- (2) Set the minutes by pressing the upper right button (B) or lower right button (A).
 - Pressing the upper right button (B) advances the display by one minute at a time each time it is pressed while pressing the lower right button (A) moves back the display by one minute at a time each time it is pressed. (Pressing either button continuously causes the display to change rapidly.)
- (3) The time up alarm number flashes each time the upper left button (C) is pressed.
- (4) Set the time up alarm number by pressing the upper right button (B) or lower right button (A).
 - Pressing the upper right button (B) once calls up the next time up alarm number each time it is pressed, while pressing the lower right button (A) once calls up the next time up alarm number in the reverse order each time it is pressed. Select "Silent" when you do not want the time up alarm to sound.
 - You can monitor the time up alarm of the number that is flashing by pressing the upper right button (B) or lower right button (A) for as long as the button is pressed. (The next or previous time up alarm number is momentarily displayed the instant the button is pressed, while pressing either button continuously causes the set time up alarm to sound.)
- (5) Press and release the lower left button (D) to return the watch to the timer setting display.

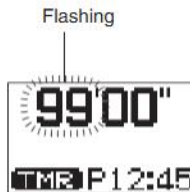

- * The watch automatically returns to the timer setting display when none of the buttons are pressed for about 3 minutes in the correction state (display flashing).
- * The watch can be immediately returned to the timer setting display by pressing the lower left button (D) and then releasing in the correction state (display flashing).

B. Timer Measuring Procedure

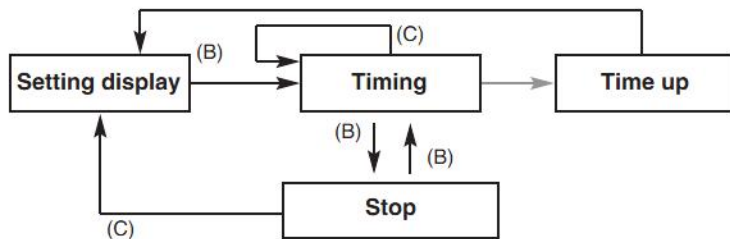

- (1) The timer is repeatedly started and stopped each time the upper right button (B) is pressed once.
- (2) The watch returns to the setting display when the upper left button (C) is pressed while the timer is stopped.

- * The alarm that sounds when the time is up can be turned off by pressing any button.
- * Only "Timer" appears on the display to indicate that the time is up when the time up alarm has been set to "Silent".
- * The watch automatically returns to the time mode after about 3 minutes have passed during the timer setting display.
- * The watch returns to the surface mode when none of the buttons have been pressed for about 3 minutes in the timer mode (including during timing) when the surface mode has been activated (while resting on the surface).
- * If the mode is switched to the dive mode, infrared communication mode or low power mode during timing, timing is interrupted and the watch returns to the setting display.

<Repeating Measurement>

The timer is instantly returned to the setting display and resumes timing when the upper left button (C) is pressed once during timer measurement.

7. Using the System Monitor Mode

This mode provides a general indication of the amount of charge remaining in the watch along with the usage status of flash memory.

A. Switching the Display

- The display switches back and forth each time the upper right button (B) is pressed once in the system monitor mode.
- The watch's identification number is displayed when the upper left button (C) is pressed and then released during the flash memory status display.

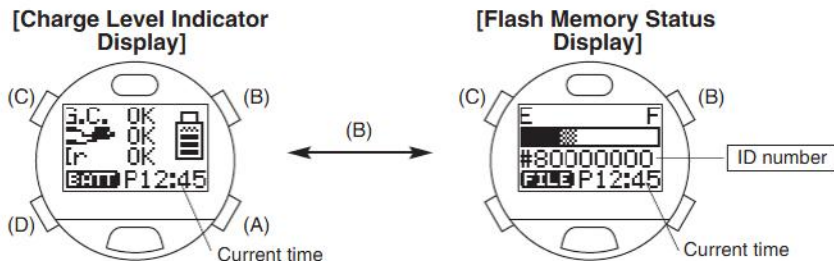

* The watch automatically returns to the time mode when none of the buttons are pressed for about 3 minutes in the system monitor mode.

* The watch identification number displayed here is required during user registration.

B. Charge Level Indicator

The charge level indicator provides a general reference for determining the amount of charge remaining in the watch. In addition, it also indicates whether or not each function can be operated ("OK" or "NG") at the current charge level. In case of insufficient power it will display "NG", however if the watch has sufficient power for a function, it will display "OK", and that function can be operated. The **CHRG** indicates that a function can be operated, but additional charging is recommended.

* Please refer to "Charge Level Indicator and Continuous Usage Time" for information on a general indicator of the amount of charge.

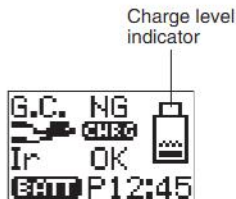

G.C.: Garbage Collection

This indicates whether or not the garbage collection operation can be performed.

* This watch uses flash memory to store the various settings and diving data of the watch edited with a personal computer. Whenever new data is recorded in flash memory, areas of memory that are no longer used as well as areas of memory in the gaps between data are generated in the flash memory. Garbage collection refers to an operation that creates continuous areas of available memory so that these areas can be reused automatically.

: Diving Function

This indicates whether or not the watch can be used for diving.

- The **CHRG** display means that the watch is insufficiently charged for use during diving. Although the dive mode continues to operate even in this state, if diving is performed while in this state, the watch may become insufficiently charged during diving. Sufficient charge the watch prior to diving to ensure safety.
- When "NG" is displayed, the watch will not switch to the dive mode. The watch can therefore not be used for diving in this state.

Ir: Infrared Communication Function

This indicates whether or not the infrared communication function can be used for data transfer with a personal computer or between watches.

C. Flash Memory Status Display

This display provides a general indication of the amount of flash memory available. In addition, garbage collection can also be performed during this display by pressing one of the buttons.

<Reading the Bar Graph>

- a: Black segment: Area in which data has been written and then deleted.
→The area corresponding to this segment is transformed into available memory by performing garbage collection.
- b: Gray segment: Area currently used by files.
→This segment becomes larger the greater the amount of diving data, daily graphic data and so forth.
- c: White segment: Area of available memory.

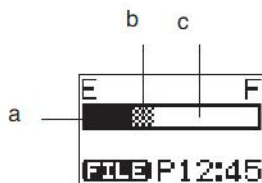

D. Garbage Collection Operating Procedure

Garbage collection begins when the upper left button (C) is pressed for at least 2 seconds and then released during the flash memory status display.

- During the garbage collection operation, an alarm sounds and "G.C." is displayed on the display. When garbage collection is completed, "Done" is displayed on the display.
- Garbage collection cannot be performed when "G.C." has changed to "NG" on the charge level indicator. "Fail" is displayed on the display at this time.

<General Reference for Performing Garbage Collection>

Try to perform garbage collection when the black segment on the flash memory status display is larger than the white segment (available memory). Garbage collection consumes considerable power. For this reason as well, in order to ensure that flash memory is used efficiently, it is recommended to perform garbage collection whenever the watch is charged (fully charged).

- * If "Error" appears on the display or "G.C." remains displayed during garbage collection, there may be a problem in the flash memory. In this case, after formatting flash memory while referring to "Formatting Flash Memory", try repeating the garbage collection procedure. If "Error" is still displayed, the watch may have a malfunction. Please request that the watch be repaired at the Citizen Service Center.
- * Garbage collection is only performed to organize the contents of flash memory. There is no risk of deleting watch settings or diving logs as a result of performing garbage collection.

Locations Displayed by this Watch

The locations displayed in the time, travel time and destination timer modes of the standard mode can be edited with a personal computer using the "CAPgm" software provided (including changing, adding and deleting locations as well as changing the order in which they are called up).

* Refer to the section on "Data Communication Functions" in this manual along with the "CAPgm" instruction manual contained on the CD-ROM provided for further details.

Locations Pre-registered in this Watch

The following locations are registered in the watch when using the watch for the first time (default status) or after having formatted flash memory. The following locations are displayed in alphabetical order (except for UTC which is the first location shown) in the correction state of each mode.

No.	Watch display	Location	Time difference	No.	Watch display	Location	Time difference
-	UTC	Coordinated Universal Time	±0	16	KUWAIT	Kuwait	+3
1	ANCHORAGE	Anchorage	-9	17	LONDON	London	±0
2	AUCKLAND	Auckland	+12	18	LA	Los Angeles	-8
3	BANGKOK	Bangkok	+7	19	MEXICO	Mexico City	-6
4	BEIJING	Beijing	+8	20	MONTREAL	Montreal	-5
5	BUENOS	Buenos Aires	-3	21	MOSCOW	Moscow	+3
6	CAIRO	Cairo	+2	22	NEW DELHI	New Delhi	+5.5
7	CARACAS	Caracas	-4	23	NEW YORK	New York	-5
8	CHICAGO	Chicago	-6	24	NOUMEA	Noumea	+11
9	DENVER	Denver	-7	25	PARIS	Paris	+1
10	DHAKA	Dhaka	+6	26	RIO	Rio de Janeiro	-3
11	DUBAI	Dubai	+4	27	ROME	Rome	+1
12	HONG KONG	Hong Kong	+8	28	SINGAPORE	Singapore	+8
13	HONOLULU	Honolulu	-10	29	SYDNEY	Sydney	+10
14	ISTANBUL	Istanbul	+2	30	TOKYO	Tokyo	+9
15	KARACHI	Karachi	+5				

Location "IrWW"

In the case the time difference (time difference from UTC) of a location of the time mode of the transmitting watch is not present in the receiving watch during transfer of time setting data between watches using the infrared communication function, "IrWW" is temporarily displayed in the location display of the receiving watch.

* Refer to section "4. Data Communication Between Watches" of "Data Communication Functions" in this manual.

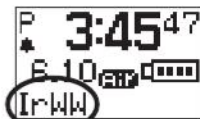

Warning Functions

This watch is equipped with various warning functions for the purpose of avoiding risks and problems when diving as much as possible.



WARNING

*** Do not dive in a manner that activates any of the warning functions.**

Since the degree of risk varies according to experience, physical condition and diving conditions, do not assume that diving is completely safe just because none of the warning functions are activated. Please use the warning functions as a general indicator of diving safety.



CAUTION

If a warning alarm sounds during diving, first begin to ascend to a shallow depth at an ascent rate of no more than 18 m (60 ft)/min to ensure safety.

Since the risk involved increases as you dive to greater depths, multiple alarms may continue simultaneously, causing multiple warning alarms to sound.

1. Types of Warning Functions and Conditions for Activation of Warning Functions

The warning functions provided by this watch along with the conditions under which each warning function is activated are as shown below.

Types of warnings	Condition for activation of warning function		
	When using on land	During AIR diving	During NITROX diving
Insufficient charge warning	●	●	●
File error warning	●	●	●
Abnormal pressure detection error warning	●		
Water sensor check warning	●		
Ascent rate warning		●	●
Abnormal depth warning		●	●
Exceed maximum depth warning		●	●
Decompression diving warning		●	
Decompression diving error			●
Permanent error warning		●	●
Permanent error		●	●
PO ₂ limit warning			●
PO ₂ limit error			●
Oxygen toxication time warning			●
Oxygen toxication time error			●

2. Explanation of Warning Functions

Insufficient Charge Warning

When the watch becomes insufficiently charged, "BATT" flashes in the lower left corner of the display in all of the modes of the standard mode. Operation of the following functions is limited while this warning function is activated.

- The watch does not switch to the dive mode even if the water sensor gets wet. (The watch automatically switches to the charge level indicator display of the system monitor mode when the water sensor gets wet.)
- None of the alarms sound.
- Data cannot be transferred by infrared communication. (However, data can be transmitted to a personal computer by USB communication.)
- The EL light is not illuminated.

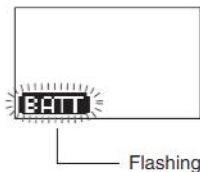

When this warning function is activated, charge the watch by attaching to the charger as soon as possible. The display will return to normal once the watch is sufficiently charged.

- * None of the dive alarms sound when the insufficient charge warning function is activated during diving. Although the dive computer will function normally for about 30 minutes after "BATT" starts to flash, the log data for that dive is not recorded after "BATT" has started flashing. Promptly begin to ascend if this warning function is activated during diving.
- * If the watch remains insufficiently charged after the insufficient charge warning function has been activated, it switches to the low power mode after about 2 days. Please note that if the watch continues to be left uncharged in the low power mode, all functions stop and all watch settings return to the initial (default) settings.

File Error Warning

When the amount of available memory in flash memory becomes low, "FILE" flashes in the lower left corner of the display in all of the modes of the standard mode as well as in the dive mode. The watch automatically switches to the flash memory status display of the system monitor mode when the water sensor gets wet while this warning function is activated. Please note that although it is possible to use the watch for diving in this state, log data may not be recorded in flash memory during diving.

The file error warning function is also activated and additional log data is not recorded if the duration of a single dive exceeds 2 hours or if more than 15 dives are made in a single day. The file error warning function may also be activated when the water temperature during diving is low. It may not be possible to receive watch settings by data communication while the file error warning function is activated.

When the watch has switched to the file error warning display, perform the garbage collection procedure in the system monitor mode of the standard mode. The display returns to normal following completion of garbage collection.

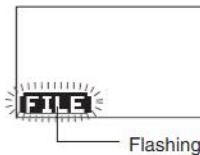

Abnormal Pressure Detection Error Warning

When abnormal atmosphere pressure is detected during use on land, or when ascending to high locations more than 3,000 m (10,000 ft) above sea level, "ERR" (Error) flashes in the lower left corner of the display. The watch does not switch to the dive mode even if the water sensor gets wet while this warning function is activated.

If "ERR" does not disappear from the display even after a long period of time, there may be a problem with the pressure sensor. When this happens, discontinue using the watch and consult a Citizen Service Center.

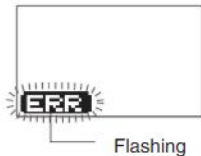

Water Sensor Check Warning

If the preliminary dive display continues to be displayed for more than 1 hour after the water sensor has gotten wet and the watch has switched to the preliminary dive display in the dive mode, "CHK" (Check) flashes in the lower left corner of the display to inform the wearer that the water sensor should be checked.

* "CHK" also flashes when the watch returns to the normal display from any of the correction states, when the watch is returned to the time mode of the standard mode from the infrared communication mode, and when the water sensor is operating during the all reset procedure.

The watch does not switch to the dive mode (water depth measurement display) when "CHK" is flashing.

To check the sensor, remove any debris or moisture from the water sensor with a dry cloth. The display returns to normal when the water sensor is canceled.

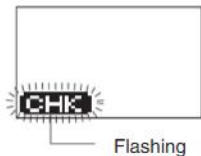

Ascent Rate Warning

When the ascent rate during scuba diving exceeds 18 m (60 ft)/min, the ascent rate warning alarm sounds for 5 seconds and "SLOW" and an illustration of a turtle are displayed at the bottom of the display.

The ascent rate warning alarm stops sounding when a proper ascent rate is resumed.

* The ascent rate warning alarm does not sound during skin diving (continuous diving for less than 3 minutes at a depth of 1 m (4 ft) or more).



Abnormal Depth Warning

When a sudden change in depth of more than 4 m (13 ft)/sec is detected during diving, the watch assumes that the watch has reached an abnormal depth. At this time, "ERR" and the diver mark are alternately displayed in the lower left corner of the display.

Once "ERR" has been displayed during diving, it continues to be displayed until the dive mode is terminated.

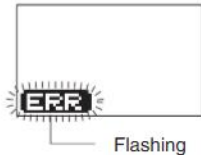

CAUTION

Avoid using this watch in environments subject to sudden changes in water pressure such as when using ocean floor excavation or similar equipment.

The vibrations from such equipment may cause a change in water pressure of "4 m (13 ft) or more per second" to be locally and momentarily applied to the pressure sensor of the watch, causing "ERR" to be displayed and preventing water depth from being displayed correctly.

Exceed Maximum Depth Warning

When the limit depth of 40 m (131 ft) for recreational diving is surpassed during the course of diving, an exceed maximum depth error occurs, the current depth flashes and the alarm sounds for 15 seconds. During diving at a depth greater than 40 m (131 ft), the warning alarm sounds for 15 seconds every minute.

This warning function is canceled when the depth returns to 40 m (131 ft) or less.

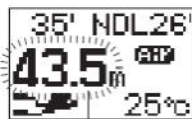

Flashing

Decompression Diving Warning

This alarm sounds for 3 seconds and the decompression stop indicator (STOP) is displayed on the display when the no-decompression limit time has been exceeded resulting in decompression diving during the course of diving.

The display returns to the no-decompression diving display when decompression stop is performed in accordance the decompression stop instructions.



Decompression Diving Error

When decompression diving takes place beyond the no-decompression limit time during diving in the NITROX setting, together with the alarm sounding for 1 second and the decompression stop indicator (STOP) being displayed on the display, the instructed depth and instructed time flash. During a decompression diving error, the instructed depth and instructed time continue to flash, and the alarm sounds for 15 seconds every minute.

Ascend to a shallow depth at a safe ascent rate as soon as possible. The display returns to the no-decompression diving display when a decompression stop is performed in accordance with the decompression stop instructions.



Flashing

Permanent Error Warning

The instructed depth flashes and an alarm sounds continuously when either of conditions 1 or 2 below are met. If hazardous diving or ascending is continued while ignoring this warning, a permanent error (ERROR) occurs:

1. When not ascending to the instructed depth and continuing to dive at an excessively low depth (diving at which the instructed decompression stop depth exceeds 9 m (30 ft),) even though having been instructed to make a decompression stop (Permanent Error Warning 1).

The warning stops when the diver begins to ascend immediately and the decompression stop instructed depth reaches 9 m (30 ft) or less.

2. When having ascended to a depth 1 m (4 ft) or more less than the instructed depth after having been instructed to make a decompression stop (Permanent Error Warning 2).

In this case, the warning is canceled when the diver returns to the instructed depth.



Flashing

Permanent Error

If hazardous diving or ascending is continued even after the permanent error warning function has been activated, a permanent error results, "ERROR" appears on the display and the entire display flashes.

When a permanent error has occurred, the next dive cannot be made for 24 hours. (The water depth measurement function does not operate for 24 hours. In addition, "ERROR" is displayed when the watch is switched to the dive plan mode, and the no-decompression limit time is not displayed.)

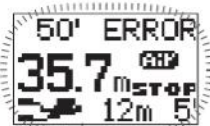

Flashing

PO₂ Limit Warning

PO₂ flashes to warn that the PO₂ limit is approaching at the depth where PO₂ (body partial pressure of oxygen) reaches 1.4 during diving in the NITROX setting.

The alarm stops when you ascend to a shallow depth and PO₂ falls below 1.4.



Flashing

PO₂ limit Error

An alarm sounds for 15 seconds every minute in addition to PO₂ flashing display when PO₂ exceeds the limit of 1.6 as a result of not ascending to a shallow depth even after the PO₂ limit warning has been activated.

The error is canceled and the display returns to the PO₂ limit warning display when you ascend to a shallow depth and PO₂ falls below 1.6.



Flashing

Oxygen Toxication Time Warning

When the amount of time remaining until the oxygen toxication time (OTT) decreases to less than 10 minutes during diving in the NITROX setting, the display in the upper right corner of the display changes from no-decompression limit time (NDL) to remaining OTT time (flashing). In the case of decompression diving, remaining OTT time flashes instead of the total ascent time in the upper right corner of the display.

The warning stops if you ascend to a shallow depth and the remaining OTT time returns to 10 minutes or more.



Flashing

Oxygen Toxication Time Error

If the remaining OTT time reaches 0 minutes as a result of not ascending to a shallow depth even after the oxygen toxication time warning has been activated, an oxygen toxication error occurs, and in addition to "0" flashing for the remaining OTT time, the alarm sounds for 15 seconds every minute.

The error is canceled and the display returns to the oxygen toxication time warning state when you ascend to a shallow depth and the remaining OTT time increases.



Flashing

Diving Terms Used by this Watch

The following provides an explanation of the diving terms displayed by this watch along with their basic meanings.

<Algorithm>

This watch employs the calculation formula of the Canadian Defense and Civil Institute of Environmental Medicine (DCIEM).

<Scuba Diving and Skin Diving>

This watch automatically distinguishes between skin diving and scuba diving according to the following conditions, and records log data separately for each type of diving.

- Scuba diving: Continuously diving for 3 minutes or more to a depth of 1 m (4 ft) or more
- Skin diving: Continuously diving for less than 3 minutes to a depth of 1 m (4 ft) or more

<No-Decompression Diving and No-Decompression Limit (NDL) Time>

No-decompression diving (NDL = No-Decompression Limit) refers to diving that allows the diver to ascend to the surface without stopping for decompression during the course of ascending following completion of a dive. The limit time during which this no-decompression diving is allowed is referred to as the no-decompression limit time. No-decompression limit time varies according to the diving depth and diving time of the previous dives.

<One Dive>

In this watch, one dive constitutes the time from initially diving to a depth of 1 m (4 ft) (start of dive) from the preliminary dive mode state to the time the dive mode is terminated (end of dive).

<NITROX Diving>

NITROX diving refers to diving in which a mixed gas of oxygen and nitrogen is used that has a higher oxygen concentration than ordinary air tanks. This watch allows the oxygen concentration (O₂%) to be set within the range of 22% to 50% in the dive plan mode.

* NITROX diving reduces the diver's risk of decompression sickness by reducing the nitrogen ratio (%) to a level lower than ordinary AIR diving. However, increasing the oxygen ratio (%) also invites the risk of "oxygen toxication" for the diver, a condition that is unpredictable in the case of AIR diving. In the case of performing NITROX diving, always make sure to receive safety training relating to NITROX diving in advance.

<AIR Diving>

AIR diving refers to diving using an ordinary air tank (compressed air having an oxygen concentration of 21%). This watch uses the term AIR diving to distinguish it from NITROX diving in which the oxygen concentration is 22% or higher.

<High-Altitude Diving and Altitude Setting>

High-altitude diving refers to diving at a high altitude of 300 m (1,000 ft) or more above sea level (such as in lakes, ponds or rivers). Since this watch calculates no-decompression time when diving by calculating body nitrogen level based on actual atmospheric pressure periodically measured while on land prior to diving, special settings are not required during high-altitude diving. However, water depth is displayed based on seawater (specific gravity: 1.025) even when diving in fresh water.

* Since atmospheric pressure at high altitudes differs from that at lower altitudes where ordinary diving is performed, high-altitude diving requires special skills. In the case of performing high-altitude diving, always make sure to receive safety training regarding high-altitude diving in advance.

<Repetitive Diving>

Repetitive diving refers to diving that is repeated while there is still residual nitrogen in the body from the previous dive. The number of the next dive for repetitive diving is displayed on the second display of the dive plan mode.

<Decompression Diving>

This refers to diving beyond the no-decompression limit time. Decompression diving is extremely dangerous since nitrogen accumulates in the body beyond allowable levels. Never dive in this manner.

<Decompression Stop>

This refers to a stop that must be made to ensure the necessary decompression in the case of having performed decompression diving. It is necessary to make a decompression stop at a predetermined depth (decompression stop instructed depth) and predetermined time (decompression stop instructed time) when ascending.

<Safety Stop>

Safety stop refers to a temporary stop made during ascending for safety reasons in order to promote expulsion of nitrogen in the body, and is performed even if the no-decompression limit time has not been exceeded. In the case of having dove to a depth of 18 m (60 ft) or more, a safety stop should always be made at 5 m (15 ft) of depth to ensure safety.

<Total Ascent Time>

This refers to the minimum time required to ascend to the surface from the current depth in the case of ascending at the rate of 18 m (60 ft)/min or less while making a decompression stop in accordance with the decompression stop instructions during decompression diving.

<Body Nitrogen Level>

This refers to the amount of nitrogen dissolved in the body as a result of diving. This watch displays a general indicator of the amount of nitrogen dissolved in the body in the form of a bar graph. The higher the level of the black portion of the graph, the greater the body nitrogen level.

<Total number of Dives (Log Count)>

This indicates the total number of dives for scuba diving.

* Arbitrarily resetting the number of past dives with the "CAPgm" software provided before using the watch for diving enables this to display the total number of scuba dives made throughout your life.

<Dive Date>

This is the date (year, month and date) on which a dive was made.

<Dive Number>

This is the number of dives made in one day. A maximum of 15 dives are counted per day for skin diving and scuba diving, respectively.

* This indicates the number of a dive for a particular dive date.
The counter is reset to 1 when the day changes.

<Surface Interval Time (S.I. Time)>

This refers to the elapsed time following completion of scuba diving (surface interval time (S.I. Time)). This watch measures surface interval time up to a maximum of 24 hours.

* S.I. Time as referred to in the scuba diving log mode represents the elapsed time from completion of the dive of the previous log until the start of the dive of the current log.

<Dive Time>

This is the total time at a depth of 1 m (4 ft) or more during a single dive.

* Measurement of dive time starts when first going below a depth of 1 m (4 ft), and stops when depth reaches less than 1 m (4 ft). However, if a dive is resumed to a depth of more than 1 m (4 ft) within 10 minutes from the time measurement of dive time stopped, dive time is continued to be measured from the time measurement stopped.

<Time In>

This is the time when the depth exceeds 1 m (4 ft) for the first time during the dive.

<Minimum Water Temperature (Min.w.temp)>

This is the minimum water temperature encountered during the course of a single dive.

<Maximum Depth (Max. Depth)>

This is the depth when having dove the deepest during the course of a single dive.

<Average Depth (Ave. Depth)>

This is the average depth during the course of a single dive.

* This refers to the average value of depth measured for every 5 seconds of dive time.

<Profile Log>

The watch displays a simple graph of the changes in depth during a dive.

* Data relating to depths measured every 5 seconds and water temperature measured every 5 minutes can be confirmed on a personal computer.

<Oxygen Concentration (O₂ %)>

This refers to the ratio (%) of oxygen in the tank used for diving. During NITROX diving, always make sure to set the oxygen concentration according to the oxygen concentration of the tank actually used in the dive plan mode. The oxygen concentration (O₂%) can be set within a range of 22% to 50%.

<Oxygen Toxication>

This refers to a rejection reaction (consisting of symptoms such as dizziness, nausea and paralysis) that occurs due to the infusion of large amounts of oxygen into the human body. This condition can be fatal in extreme circumstances.

<Partial Pressure of Oxygen in the Body (PO₂)>

The partial pressure of oxygen in the body (PO₂) refers to the absolute pressure (ATA) of oxygen that acts within the body. The partial pressure of oxygen in the body is determined by the NITROX oxygen concentration and depth, and increases as depth becomes deeper. In general, the limit at which oxygen toxication occurs in the human body is said to be PO₂ = 1.6 (ATA). The display of this watch flashes when PO₂ is between 1.4 and 1.5, and when PO₂ reaches 1.6 or higher, an alarm sounds to warn the diver.

<Oxygen Toxication Time (OTT)>

Oxygen toxication time (OTT) refers to the limit time of oxygen toxication. The oxygen toxication time is determined by the NITROX oxygen concentration, depth and dive time. In this watch, when the amount of time remaining until oxygen toxication time decreases to less than 10 minutes, the amount of time remaining until OTT flashes on the display, and when the oxygen toxication time reaches 0 minutes, an alarm sounds to warn the diver.

Using the Dive Plan Mode

This mode is used to set the plan for the next dive. The dive plan mode uses the three displays described below.

- Dive Condition Display: This lets you change between AIR diving and NITROX diving and set the oxygen concentration (O₂%). Continuously displays the current settings.
- Dive Plan Display: This lets you display the number of the next dive for repetitive diving, a graph of the body nitrogen level, and the no-decompression limit time corresponding to initial and repetitive diving.
- Dive Alarm Display: This lets you display and set the depth alarm and dive time alarm.

1. Switching the Display

The display changes each time the lower right button (A) is pressed once in the dive plan mode. The displayed contents differ between when the watch is set to AIR and when it is set to NITROX diving.

<AIR Diving>

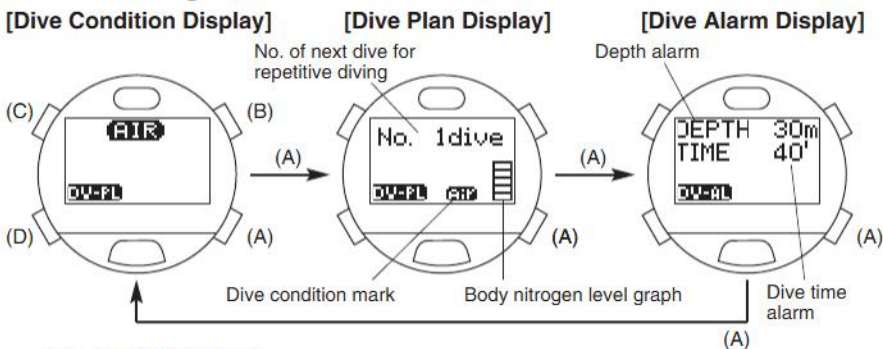

<NITROX Diving>

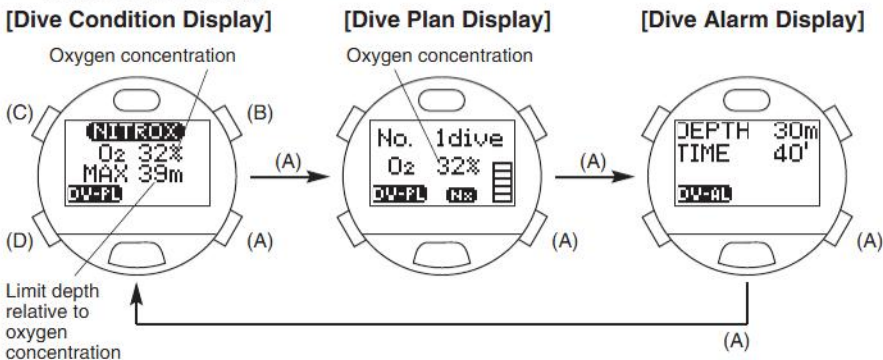

- * If none of the buttons are pressed for about 3 minutes during each of the displays of the dive plan mode, the watch automatically returns to the time mode of the standard mode.
- * The dive condition mark of the dive plan display changes to the high altitude mark in environments at an air pressure equivalent to high-altitude diving.

2. NITROX Setting

The NITROX setting is for use when diving with a mixed gas having an oxygen concentration that differs from that of air tanks used for ordinary diving (oxygen concentration: 21%). Set the watch to AIR for all other types of diving. The watch will return to the AIR dive mode automatically after 6 hours have elapsed without diving, or, 30 minutes have elapsed during surface interval time after NITROX diving.





DANGER

Always double check the oxygen concentration (O₂%) before each and every NITROX dive.

It is very important to ensure that the percentage of oxygen carried in your tank, matches the setting of the watch exactly. Failure to comply with this instruction may result in decompression sickness, oxygen toxication or death .

The oxygen concentration (O₂%) setting cannot be changed whilst diving, therefore always check that the correct O₂% is set before diving.

3. High-Altitude Setting

Since air pressure decreases at high altitudes, it is necessary to take this change in air pressure into consideration when calculating the body partial pressure of oxygen. This watch periodically measures air pressure and then calculates the body partial pressure of oxygen each time based on the measured air pressure, thereby eliminating the need to manually set the watch for high altitudes. In environments where air pressure is low, the watch automatically judges the environment to be a high-altitude environment, and the dive condition mark changes to the high altitude mark ( or ). The altitude at which the dive condition mark changes to the high altitude mark is about 300 m (1,000 ft) above sea level.



CAUTION

The high altitude mark is only intended to serve as a general indicator of high altitude. There may be times when the dive condition mark does not change to the high altitude mark even at altitudes above 300 m (1,000 ft) above sea level, or times when the dive condition mark changes to the high altitude mark even though the watch is at a low altitude below 300 m (1,000 ft) above sea level. In any case, the watch can still be used without risk since the dive computer calculates the body partial pressure of oxygen corresponding to the air pressure at that time.

4. Dive Condition Marks

The dive condition currently set for each of the time modes of the standard mode, the dive plan display in the dive plan mode and the surface mode is displayed using one of the four types of marks indicated below.

- Identification of the AIR or NITROX setting for the next dive set in the dive plan mode
- Identification of high-altitude diving automatically set according to the air pressure measured by the pressure sensor

 AIR setting

 AIR setting and high-altitude diving

 NITROX setting

 NITROX setting and high-altitude diving

* The dive condition mark ( or ) flashes for about 1 hour to warn the diver in the case the watch has automatically returned to the AIR setting from the NITROX setting.

5. Switching Dive Condition and Setting Oxygen Concentration (O₂%)

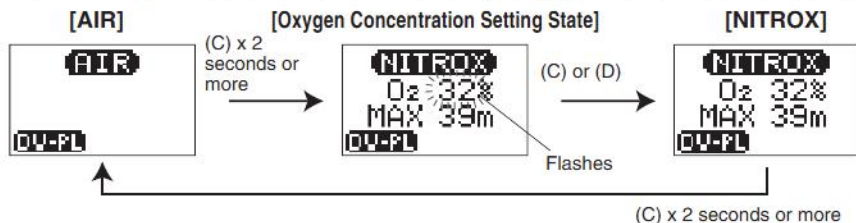

A. NITROX Setting and Oxygen Concentration Setting

- (1) The watch switches to the NITROX "Oxygen Concentration Setting State" (display flashes) when the upper left button (C) is pressed for 2 seconds or more and then released during the dive condition display ("AIR" display).
- (2) Set the oxygen concentration (O₂%) by pressing the lower right button (A) or upper right button (B).
 - * Oxygen concentration increased by 1% each time the upper right button (B) is pressed once, and decreases by 1% each time the lower right button (A) is pressed once. (Oxygen concentration can be corrected rapidly by continuously depressing either button.)
- (3) The oxygen concentration setting is finalized by pressing the upper left button (C) or lower left button (D) and then releasing.

* Oxygen concentration (O₂%) can be set between 22% and 50%.

* If none of the buttons are pressed for about 3 minutes in the oxygen concentration setting state (display flashing), the flashing oxygen concentration setting is finalized automatically and the watch changes to the NITROX setting display.

* In the case of changing the oxygen concentration setting after it has been set, reset the oxygen concentration after first returning to the "AIR" setting display.

B. Switching from NITROX Setting to AIR Setting

After about 30 minutes have elapsed for surface interval time after having performed scuba diving in the "NITROX" setting, an alarm sounds and the watch automatically returns to the "AIR" setting. In addition, if scuba diving is not performed for about 6 hours after having set the watch to NITROX, the watch automatically returns to the "AIR" setting. In the case of returning to the "AIR" setting after having set the watch to "NITROX", return the watch to the "AIR" setting by pressing the upper left button (C) for 2 seconds or more and then releasing during the "NITROX" display.

6. Calling Up No-Decompression Limit Time

- (1) The no-decompression limit time corresponding to a depth of 12 m (40 ft) is displayed when the upper right button (B) is pressed once during the dive plan display.
- (2) No-decompression limit times are called up in order for every 3 m (10 ft) of depth each time the upper right button (B) is pressed once. Repeatedly press the upper right button (B) until the depth corresponding to the depth of the next scheduled dive is displayed.

* No-decompression limit time changes according to the diving depth of the previous dive, dive time and surface interval time.



Displayed Depth

This watch displays no-decompression limit time for the following 12 depths.
12m, 15m, 18m, 21m, 24m, 27m, 30m, 33m, 36m, 39m, 42m, 45m
(40 ft, 50 ft, 60 ft, 70 ft, 80 ft, 90 ft, 100 ft, 110 ft, 120 ft, 130 ft, 140 ft, 150 ft)



WARNING

Please dive while allowing ample margin with respect to the displayed no-decompression limit time to ensure safety.

7. Dive Alarm

<Depth Alarm>

The depth display flashes and an alarm sounds for 15 seconds at 1 minute intervals (for the set number of times) to warn the diver when the diver remains at a depth deeper than the set depth while diving. The alarm stops sounding when the diver ascends to a depth less than the set depth, and sounds again if the diver descends deeper than the set depth.

- Setting range: 10 m (33 ft) to 39 m (130 ft) (1 m (4 ft) units), OFF
- No. of times alarm sounds: 1 to 5 times, ON (no limit)

<Dive Time Alarm>

The dive time display flashes and an alarm sounds for 15 seconds when the set time elapses from the start of the dive. This alarm sounds only once.

- Setting range: 5 min to 90 min (5 min intervals), OFF

A. Setting the Dive Alarm

- (1) The watch enters the correction state (display is flashing) when the upper left button (C) is pressed for at least 2 seconds and then released during the dive alarm display. The flashing item on the display can be corrected.
- (2) The flashing item changes in the order shown below each time the upper left button (C) is pressed once.
 - The display returns to the normal display when the upper left button (C) is pressed and then released in the dive time correction state.

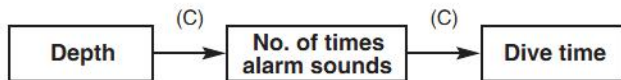
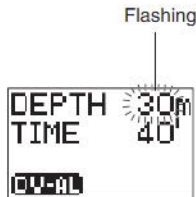

- (3) Correct the flashing item by pressing either the upper right button (B) or lower right button (A).
 - Pressing the upper right button (B) advances the display by one step at a time each time it is pressed, while pressing the lower right button (A) moves the display back by one step at a time each time it is pressed. (Pressing either button continuously causes the display to change rapidly.)
 - Correction of the number of times the alarm sounds is skipped when the depth alarm is set to OFF.
- (4) Press and release the lower left button (D) finalize the settings.

- * Set each parameter to OFF when you do not want the depth alarm and dive time alarm to sound.
- * The watch automatically returns to the normal dive alarm display when none of the buttons are pressed for about 3 minutes in the correction state (display flashing).
- * The watch can be immediately returned to the normal dive alarm display by pressing the lower left button (D) and then releasing in the correction state (display flashing).

B. Dive Alarm Monitor

Each alarm sound repeatedly sounds for 4 seconds each in the order of the depth alarm, dive time alarm and ascent rate alarm for as long as the upper right button (B) is pressed during the dive alarm display.

- * Refer to the section on "Warning Functions" for information on the ascent rate warning alarm.

Using the Scuba Diving Log Mode and Skin Diving Log Mode

The scuba diving log mode is used to display the scuba diving log automatically recorded by the watch during scuba diving. The skin diving log mode is used to display the skin diving log automatically recorded by the watch during skin diving. A maximum of 100 sets of log data can be recorded for both scuba diving and skin diving (provided that the dive time of a single dive is within 2 hours and no more than 15 dives per day). The contents of log data for a single dive are displayed using three displays for both the scuba diving log and skin diving log modes.

1. Calling Up Scuba Diving Log Data

- (1) The most recent scuba diving log data is displayed when the watch is switched to the scuba diving log mode by pressing the lower left button (D).
- (2) The log data that you want to view can be selected by pressing either the lower right button (A) or upper right button (B). Logs are identified according to the number of the dive (No.) among the total number of dives.

* Old log data is called up each time the lower right button (A) is pressed once, while new log data is called up each time the upper right button (B) is pressed once. (Pressing either button continuously causes the log data to change rapidly.)

- (3) The display of the selected log data changes each time the upper left button (C) is pressed once.

<1st Display>

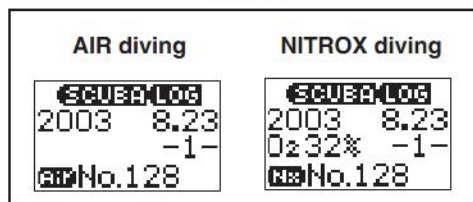

- Dive date
- -1-: Number of dive (first dive on that day)
- O₂**%: Oxygen concentration
- No. : Total number of dives
- **Air** : Dive condition mark (Air)

(C)
<2nd Display>



- Surf: Surface interval time
- ▼ : Time in
- ▲ : Time out
- Div. T: Dive time
- Minimum water temperature
- DECO: Decompression dive record

(C)
<3rd Display>

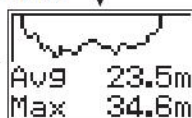

- Profile log
- Avg: Average depth
- Max: Maximum depth

- * The dive condition mark displayed on a first display represents the dive condition for that dive.
- * The oxygen concentration set before diving on the first display is displayed for the log data during NITROX diving.
- * "DECO" is displayed on the second display in the case decompression diving has occurred during diving.
- * "NO LOG" is displayed when there is no log data stored in the watch.
- * "--. m" is displayed for maximum depth when the maximum depth during diving has exceeded 80.0 m (266 ft).
- * The average depth flashes when an error has occurred in water depth measurement while diving.
- * The minimum water temperature flashes when the water temperature has exceeded the water temperature measuring range while diving.
- * Reference values for dive time, time out, maximum depth, average depth and minimum water temperature are displayed flashing while recording of log data is interrupted during diving due to the watch becoming insufficient charged.
- * Slightly more time may be required to call up log data when there is a large amount of log data stored in the watch. In such cases, "WAIT" is displayed while the log data is being called up. The water sensor and all buttons do not function while "WAIT" is being displayed.

2. Calling Up Skin Diving Log Data

- (1) The most recent skin diving log data is displayed when the watch is switched to the skin diving log mode by pressing the lower left button (D).
- (2) The log data that you want to view can be selected by pressing either the lower right button (A) or upper right button (B). Logs are identified according to the date and dive number.
 - Old log data is called up each time the lower right button (A) is pressed once, while new log data is called up each time the upper right button (B) is pressed once. (Pressing either button continuously causes the log data to change rapidly.)
- (3) The display of the selected log data changes each time the upper left button (C) is pressed once.

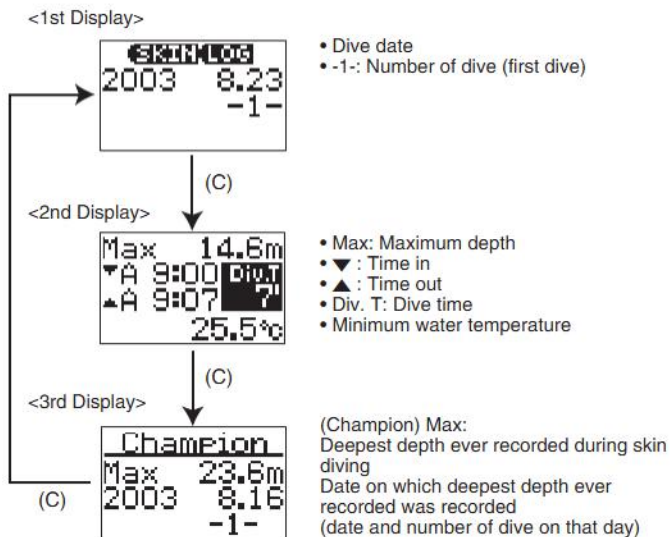

- * "NO LOG" is displayed when there is no skin diving log data recorded.
- * Maximum depth is displayed as "--. m" when the maximum depth has exceeded 80.0 m (266 ft) while diving.
- * "--. °C" is displayed for minimum water temperature in the case of log data for which the dive time is less than 1 minute.
- * Calling up log data may take some time when there is a large amount of log data recorded. In such cases, "WAIT" is displayed while log data is being called up. The water sensor and none of the button operations function while "WAIT" is displayed.

3. Deleting Log Data

Individual sets of log data cannot be deleted. When a new dive is made when there are already 100 sets of dive data recorded for the total dive data of scuba diving log data and skin diving log data, the oldest log data is automatically deleted.



CAUTION

It is strongly recommended to promptly record important log data in another storage medium.

When a new dive is made and there are already 100 sets of dive data recorded for the total dive data of scuba diving log data and skin diving log data, the oldest log data is automatically deleted. In addition, since there is also the possibility of data being lost due to a malfunction in the watch or during repairs or inspections, it is recommended to promptly transfer data to a personal computer following completion of diving. Please note that the manufacturer cannot be responsible for data that is lost due to a malfunction.

Using the Dive Mode

This mode measures water depth while in the water. The watch automatically switches to the dive mode when the water sensor detects water in any mode except for the infrared communication mode and power save mode. The watch automatically begins to measure water depth when the water depth reaches 1 m (4 ft) or more during the preliminary dive display. During diving, the dive computer performs calculations corresponding to the set dive condition, and displays information required by the diver, including the current depth, dive time and maximum depth.

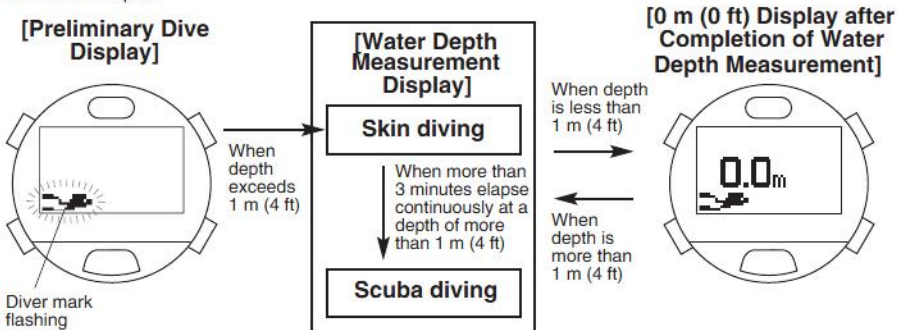

- During the preliminary dive display, the diver mark flashes in the lower left corner of the display and the display of each mode prior to switching to the preliminary dive display is maintained.
- Once measurement of water depth begins, if diving continues for more than 3 minutes at a depth of more than 1 m (4 ft), the watch switches to the scuba diving display and displays no-decompression limit time.
- The diver mark flashes in the lower left corner of the display while diving.



DANGER

During NITROX diving, always make sure to check that the oxygen concentration (O₂%) is correctly set to the oxygen concentration of the tank actually used prior to diving.

Oxygen concentration (O₂%) cannot be set or changed while in the water or after starting a dive. Always make sure to set oxygen concentration prior to diving.



WARNING

Before starting a dive, always make sure to check that the "Diver Mark" is flashing in the lower left corner of the display during the preliminary dive display.

The water depth measurement function will not operate if "BATT", "ERR" or "CHK" is flashing in the lower left corner of the display during the preliminary dive display (indicating that a warning function has been activated). In the state in which "CHRG" (Charge) is displayed, the watch may become insufficiently charged while diving. In addition, even if the insufficient charge warning function ("BATT" is displayed) has not been activated, to avoid the watch becoming insufficiently charged while diving, start the dive after first sufficiently charging the watch.

* Refer to "Warning Functions" for further details.

1. Explanation of Display During Water Depth Measurement

The display during diving differs between the AIR setting (air diving) and NITROX setting (NITROX diving). Even in the case of performing scuba diving, the watch displays the skin diving display until 3 minutes or more have elapsed continuously at a depth of 1 m (4 ft) or more.

A. Display during AIR Setting

During Skin Diving

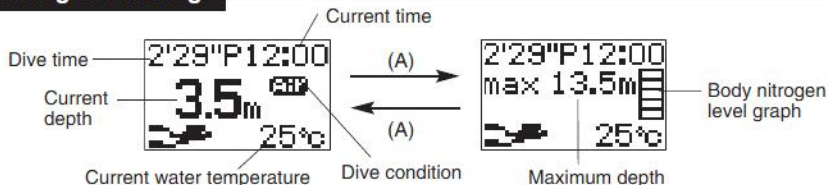

- Maximum depth and the body nitrogen level graph are called up for about 10 seconds when the lower right button (A) is pressed once.

When 3 minutes or more elapse continuously at a water depth of 1 m (4 ft) or more

During Scuba Diving

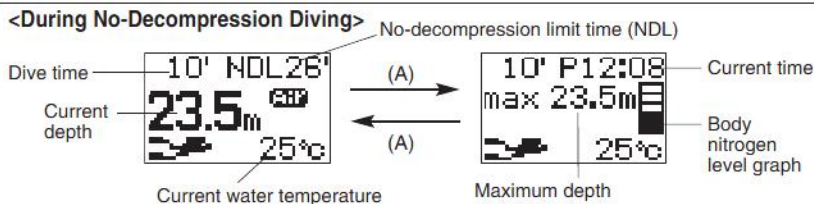

When no-decompression limit time is exceeded

When decompression stop instructions are followed

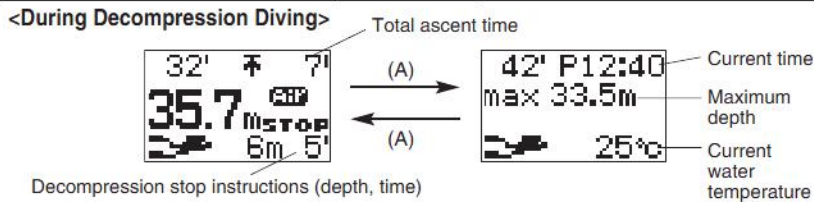

- If diving is continued beyond the no-decompression limit time, an alarm sounds and decompression stop instructions (STOP) are displayed on the display indicating that decompression diving has occurred.
- Pressing the lower right button (A) once during scuba diving calls up the current time, maximum depth, water temperature and body nitrogen level graph (the body nitrogen level graph is not displayed during decompression diving).

B. Display during NITROX Setting

During Skin Diving

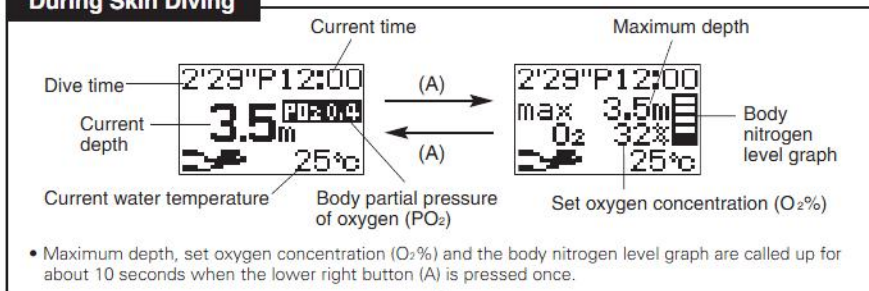

When 3 minutes or more elapse continuously at a water depth of 1 m (4 ft) or more

During Scuba Diving

<During No-Decompression Diving>

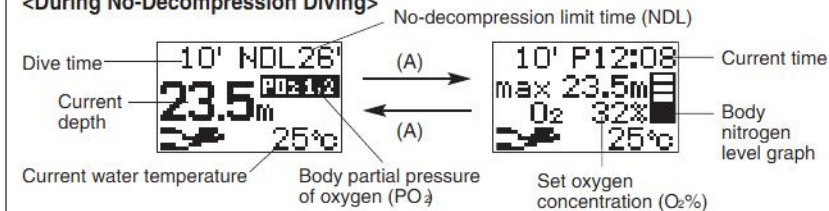

When no-decompression limit time is exceeded

When decompression stop instructions are followed

<During Decompression Diving>

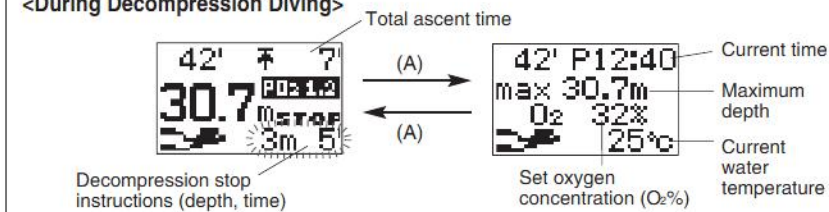

- If diving is continued beyond the no-decompression limit time, an alarm sounds and decompression stop instructions (STOP) are displayed on the display indicating that decompression diving has occurred.

- Pressing the lower right button (A) once during scuba diving calls up the current time, maximum depth, set oxygen concentration, water temperature and body nitrogen level graph (the body nitrogen level graph is not displayed during decompression diving).



DANGER

Never dive in a manner that requires a decompression stop (decompression diving).

If decompression diving should happen to occur, immediately start to ascend while observing an ascent rate of no more than 18 m (60 ft)/min. Make a decompression stop while ascending in accordance with decompression stop instructions.

When making a decompression stop, never ascend to a depth less than the instructed depth. In addition, since it is difficult to maintain a constant depth when there are high waves and so forth, make decompression stops at depths a little deeper than the instructed depth to prevent decompression sickness.

* A permanent error (ERROR) occurs when continuing to dive while ignoring decompression stop instructions during the course of decompression diving, and the watch will not switch to the dive mode for 24 hours after that time.

2. Safety Stop Graph and Decompression Stop Graph

A. Safety Stop Graph Display

A graph serving as a general reference for changes in depth during safety stop and the elapsed time during a safety stop are displayed after having descended to a depth of more than 5 m (15 ft) and then ascended to a depth of 5 m (15 ft) during scuba diving (no-decompression diving).

Reading the Safety Stop Graph

The horizontal axis of the graph represents elapsed time, while the vertical axis represents changes in depth over a range of 3 m (10 ft) to 7 m (23 ft) centering around a depth of 5 m (15 ft).

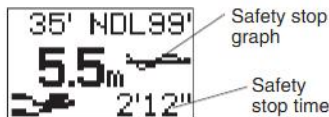

B. Decompression Stop Graph

When having ascending to the instructed depth of the decompression stop during decompression diving, a graph is displayed that provides a general reference for changes in depth during decompression stop at a depth of the instructed depth ± 1 m (4 ft).

Reading the Decompression Stop Graph

The horizontal axis of the graph represents elapsed time, while the vertical axis represents changes in depth over a range of ± 1 m (4 ft) from the decompression stop instructed depth.

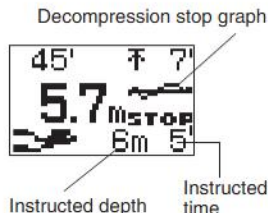

3. Depth Measurement

This watch measures depth every second, and continuously displays the current depth in 0.1 m (0.3 ft) units during the course of diving.

• Measuring range: 1 m to 80 m (4 ft to 266 ft)

* 0 m (0 ft) is displayed at depths of less than 1 m (4 ft), while --. m is displayed at depths greater than 80 m (266 ft).

* When an error has occurred in depth measurement during the course of diving, "ERR" and the diver mark are alternately displayed until that dive is completed.

4. Dive Time Measurement

The elapsed time of dives made to a depth of more than 1 m (4 ft) is displayed. Measurement of dive time starts automatically when the depth exceeds 1 m (4 ft) for the first time, and stops when the depth again is less than 1 m (4 ft). However, if a dive is resumed to a depth of more than 1 m (4 ft) within 10 minutes from the time measurement of dive time stopped, dive time is continued to be measured from the time measurement stopped. Dive time is displayed for up to 9 minutes 59 seconds from the start of measurement in 1 second units. Beyond that time, dive time is displayed in 1 minute units.

- Measuring range: 0 minutes 00 seconds to 999 minutes 59 seconds

5. Water Temperature Measurement

The watch begins to measure water temperature one minute after the water depth reaches a depth greater than 1.0 m (4 ft), and the most recently measured water temperature is continuously displayed in 1°C (1°F) units at 1 minute intervals while diving. However, water temperature is only displayed when the lower right button (A) is pressed during decompression diving. (Water temperature measured in 0.1°C units rounded and displayed 1°C (1°F) units.)

- Measuring range: -9.4°C to +40.0°C (15°F to 104°F)

6. No. of Dives Per Day and Recording Log Data

A maximum of 15 dives of log data can be recorded per day for both skin diving and scuba diving. When the number of sets of log data exceeds 15, log data is no longer recorded during diving. Even though log data is not recorded, the watch will continue to measure depth and perform its various other functions during diving.

In case the number of dives per day for skin diving exceeds 15, and the number of dives per day for scuba diving is 14 or less, "FILE" mark is displayed for the first 3 minutes on the watch display. But scuba diving log is held properly. After 3 minutes, the watch display automatically changes to scuba diving instead of skin diving, then "FILE" mark disappears.

7. Ending the Dive Mode

- The watch returns to the surface mode or the time mode of the standard mode when the lower left button (D) is pressed for at least 2 seconds and then released when 0 m (0 ft) is displayed after completion of a dive.
- The watch automatically returns to the surface mode or time mode of the standard mode after roughly 10 minutes have elapsed since 0 m (0 ft) is displayed following water depth measurement.

<0 m (0 ft) Display After AIR Diving>



<0 m (0 ft) Display After NITROX Diving>



Using the Surface Mode

The surface mode is used to display elapsed time from the end of the most recent scuba dive (S.I. time) and the amount of time remaining until boarding an aircraft is permitted (no fly time).



DANGER

Avoid traveling in an aircraft while the surface mode is activated.

Traveling in an aircraft without allowing sufficient time to rest after diving results in the risk of decompression sickness. It is recommended to avoid traveling in an aircraft for at least 24 hours after diving whenever possible even if the surface mode is no longer displayed. There are no rules for completely preventing decompression sickness caused by flying in an aircraft after diving.

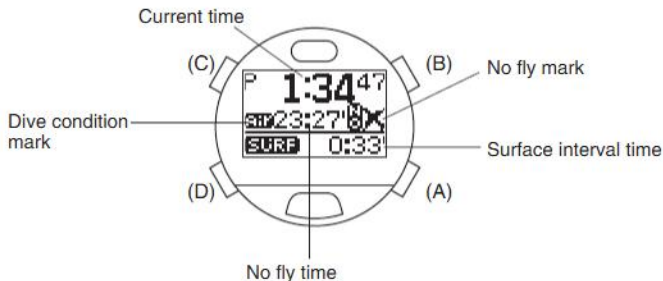

- * The surface mode is preferentially displayed at all times after scuba diving.
- * When the no fly time reaches 0 hours 00 minutes, the watch exits the surface mode, and returns to the time mode of the standard mode. The surface mode is not displayed after that time until completion of the next scuba dive.
- * If the watch is insufficiently charged (when the level of the charge level indicator is , **SURF** in the lower left corner of the display in the surface mode changes to **CHRG** to indicate that the watch should be charged.

Low power mode (Temporary function)

The low power mode is a special mode for allowing the watch to run while using the minimum amount of current consumption. When the watch becomes insufficiently charged, it automatically switches to this mode to conserve current consumption. In addition, the watch can be manually switched to the low power mode by pressing the lower right button (A) and lower left button (D) simultaneously for at least 2 seconds and then releasing in the time mode of the standard mode.

* Since all functions except for the time/date display and correction functions do not operate in the low power mode, do not use this mode when using (wearing) the watch under normal circumstances.

1. Switching the Display

- The time and date displays switch back and forth each time the lower right button (A) is pressed once.
- The entire display goes out (no display) when the lower left button (D) is pressed for at least 2 seconds and then released during the time display or date display. Pressing the lower left button (D) again for at least 2 seconds and then releasing returns the watch to the time display.
- The watch returns to the time mode of the standard mode (or to the surface mode when the surface mode has been activated) when the lower right button (A) and lower left button (D) are pressed simultaneously for at least 2 seconds and then released during the time display or date display.

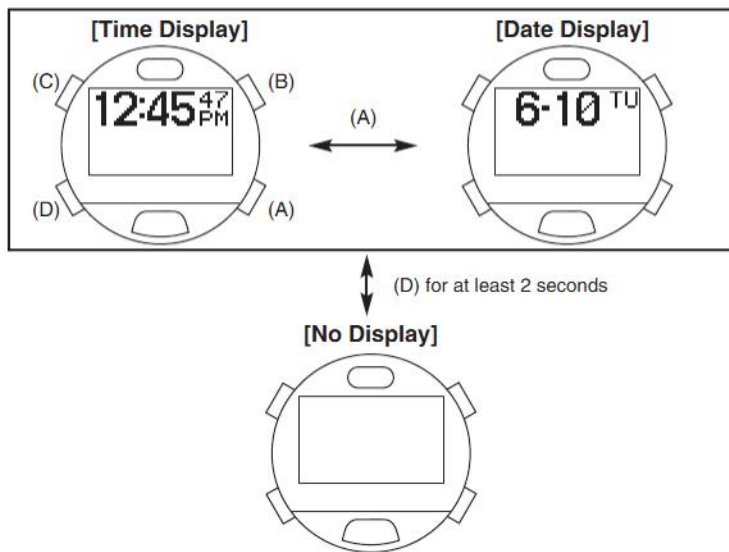

- * When the watch has switched to the low power mode as a result of being insufficiently charged, the watch does not return to the time mode of the standard mode even if the lower right button (A) and lower left button (D) are pressed simultaneously for at least 2 seconds and then released. In this case, the watch will only return to the time mode of the standard mode when the watch has been sufficiently charged and the lower right button (A) and lower left button (D) are again pressed simultaneously for at least 2 seconds. If the watch has been left not recharged in the low power mode, it will become completely discharged and all the functions will stop.
- * When there is no display, the amount of current consumed is even less than during the time display or date display.

2. Setting the Time and Date

Flashing

- (1) The watch enters the correction state (display is flashing) when the upper left button (C) is pressed for at least 2 seconds and then released during the time display or date display.
- (2) The flashing item changes in the order shown below each time the upper left button (C) is pressed and then released.

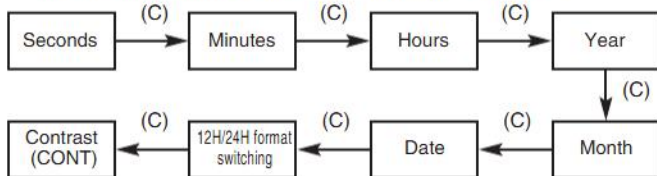

- (3) Correct the flashing item by pressing the upper right button (B).
 - Pressing the upper right button (B) advances the display by one step at a time each time it is pressed. (Pressing the upper right button (B) continuously causes the display to change rapidly.)
 - The watch returns to 00 seconds when the upper right button (B) is pressed while correcting seconds. (The minutes advance by 1 minute if the seconds are between 30 and 59 seconds at that time.)
 - When switching the 12H/24H format, the display switches back and forth between the 12 hour and 24 hour format each time the upper right button (B) is pressed.
- (4) Pressing the lower left button (D) once returns the watch to the normal display.

- * The time and date of the main location in the time mode of the standard mode can be displayed and corrected in the low power mode. Changes made to the time and date in the low power mode are retained even after returning to the time mode of the standard mode.
- * The year can be set from 2000 to 2099.
- * Dates such as February 30 that do not actually exist are not displayed even during correction.
- * Pay attention to AM (A) and PM (P) when using the 12 hour format.
- * The day is corrected automatically by correcting the year, month and date.
- * The watch automatically returns to the normal display (time display or date display) when none of the buttons are pressed for about 3 minutes in the correction state (display flashing).
- * The watch can be immediately returned to the normal display by pressing the lower left button (D) once in the correction state (display flashing).

Data Communication Functions

Data is transferred between watches or between the watch and personal computer using the data communication functions. There are two ways for transferring data: the first involves using the infrared communication interface, and the second involves using the communication unit (USB communication interface) function.

1. Infrared Communication

The infrared communication function of this watch uses an infrared (Ir) beam for communication in the same manner as the remote controllers of television sets and VCRs. Communication is performed between watches or between the watch and a personal computer by transmission and reception of this infrared beam by their respective infrared transmission/reception units.

* The infrared communication function of this watch complies with the wrist watch infrared communication standard IrWWW (IrDA for Wrist Watches).

A. Communication Range

The maximum distance infrared communication can be performed with this watch is 15 cm (5.9 inch) in the vertical direction to the infrared transmission/reception unit. Although directivity has a margin of about $\pm 15^\circ$, the communication distance becomes shorter as the angle becomes wider.

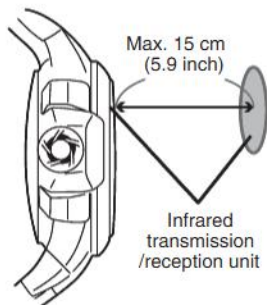

- * Remove any obstacles between the watches or between the watch and the personal computer during infrared communication.
- * Data may not be able to be transferred or an error may occur if other infrared communication devices are nearby during infrared communication.
- * Avoid moving the watch as much as possible during infrared communication.
- * Perform infrared communication within a temperature range of $+10^\circ\text{C}$ to $+35^\circ\text{C}$ (50°F to 95°F). Data may not be able to be transferred if outside this range.
- * Data may not be able to be transferred or an error may occur if infrared communication is performed directly beneath a fluorescent lamp or in direct sunlight.
- * When transferring data between the watch and a personal computer using infrared communication, the personal computer also must be set to be able to use infrared communication. Refer to the instruction manual of the personal computer for information on setting the personal computer for infrared communication.

B. Infrared Communication Mode Operating Procedure

The procedure for data transfer is performed with the "Infrared Communication Mode" of the watch.

Infrared Communication Mode (Initial Display)

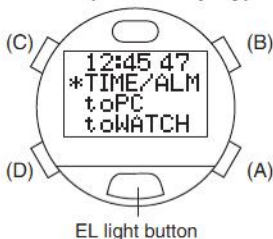

- (1) The watch enters the infrared communication mode initial display when the lower left button (D) is pressed for at least 2 seconds and then released in any mode.
- (2) The menu changes each time the upper left button (C) is pressed once, and the menu of the selected menu is displayed when either the upper right button (B) or the EL light button is pressed once. (The menu indicated with an asterisk mark is the selected menu.)
- (3) The selected communication menu is activated when the upper right button (B) or the EL light button is pressed once when the lowermost menu is displayed.

<Display Sequence in Infrared Communication Mode>

<Initial display>

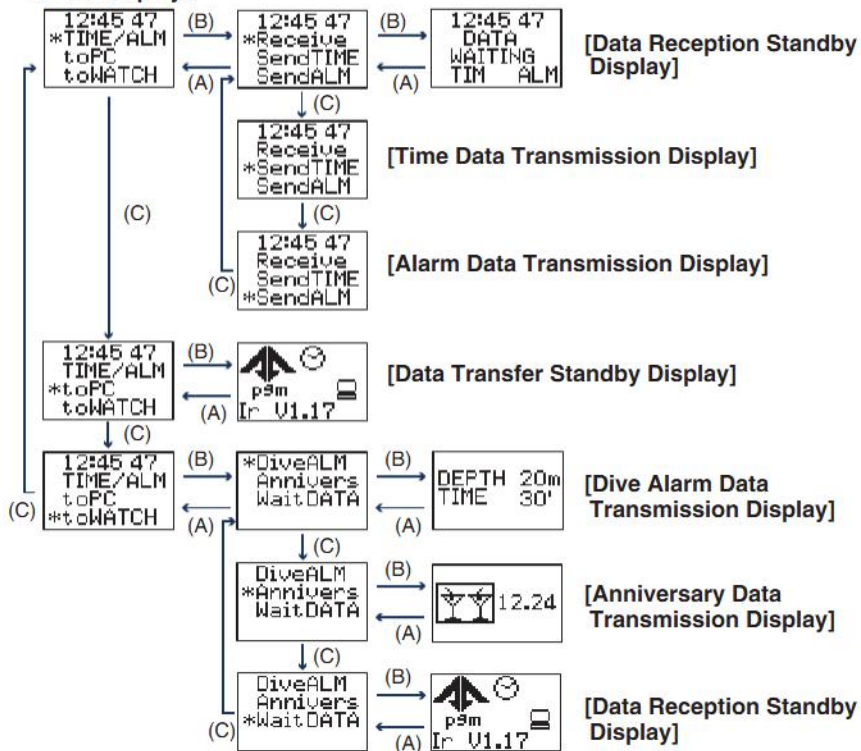

- * Pressing the lower right button (A) once when any menu is displayed returns the display to the previous menu.
- * The watch returns to the time mode of the standard mode when the lower right button (A) is pressed once during the initial infrared communication display.
- * The watch can be immediately returned to the time mode of the standard mode by pressing the lower left button (D) for at least 2 seconds and then releasing when any menu is displayed.
- * The display automatically returns to the previous menu when none of the buttons are pressed for about 1 minute during the display of any menu (or for about 3 minutes during time data transmission display).
- * The watch automatically returns to the time mode of the standard mode when none of the buttons are pressed for about 1 minute during the initial infrared communication display.

2. Communication by USB Interface

The communication unit is used during data communication by USB interface.

- * Please purchase the separately sold communication unit when you want to use a USB interface for communications between the watch and PC.
- * When performing data communications with your PC using the communication unit, it is necessary to install a USB driver in the PC being used in advance.
- * Refer to "Communication Unit" in this manual for more details on the communication unit and driver installation procedure.

3. Data Communication with PC

There are two ways for transferring data between the watch and a personal computer. The first involves using the infrared communication function, and the second involves using the communication unit (sold separately). Data can be edited on the PC using the software provided (contained on the accessory CD-ROM) after transferring data to the PC. The following indicates data that can be transferred to the PC.

a. Diving Log and Profile Data

→Diving data that has been transferred to the PC can be edited and managed using the AQUALAND GRAPH Nx software provided. For further details, refer to the section on "Accessory Software" in this manual and the "AQUALAND GRAPH Nx" manual contained in the accessory CD-ROM.

b. Watch Settings

→Watch settings that can be transferred to the PC include location information (name and time difference from UTC), alarm, timer, travel time, daily graphic and dive alarm settings. Setting data incorporated using the "CAPgm" software provided can be edited on the PC, and edited settings can be sent back to the watch. For further details, refer to the section on "Accessory Software" of this manual and the "CAPgm" manual contained in the accessory CD-ROM.

- * The accessory software contained in the accessory CD-ROM must be installed prior to transferring data between the watch and PC.
- * Perform infrared communication and communication using the USB interface within a temperature range of +10°C to +35°C (50°F to 95°F). Data may not be able to be transferred if outside this range.

A. Preparations for Communication

Infrared Communication

The watch is switched to the data transfer standby display of the infrared communication mode.

Infrared Communication Mode
(Transfer Standby Display)

- (1) The watch enters the infrared communication mode (initial display) when the lower left button (D) is pressed for at least 2 seconds and then released in any mode.
- (2) Select "toPC" by pressing the upper left button (C) once. (The "*" mark moves to the left of "toPC".)
- (3) The watch is switched to the data transfer standby display by pressing the upper right button (B).



* Refer to part "B. Infrared Communication Mode Operating Procedure" of the previous section "1. Infrared Communication" for a detailed explanation of the procedure for using the infrared communication mode.

USB Communication

- (1) Connect the personal computer and communication unit with the USB cable (sold separately).

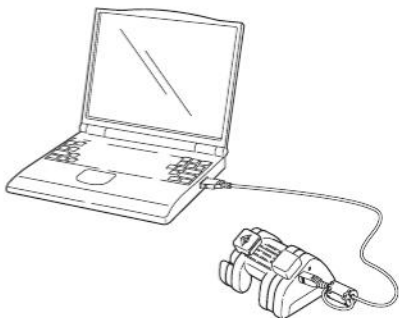

☆ Attachment of Ferrite Core

When performing data communication using the USB communication interface, always make sure to attach a ferrite core to the special-purpose USB cable.

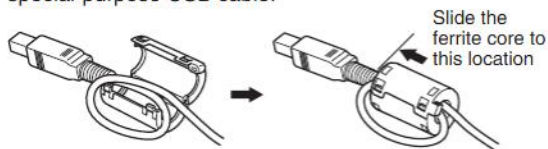

Loop the USB cable once at the base of the B type connector (side that is connected to the communication unit), insert the overlapping portion of the cable into the groove inside the ferrite core and securely close the ferrite core.



CAUTION

Always make sure to attach the ferrite core enclosed with the communication unit to the USB cable prior to use.

Failure to properly attach the ferrite core may cause electromagnetic interference to affect other equipment.

- * The USB cable and ferrite core are enclosed with the communication unit.
- * Connect the communication unit directly to the personal computer with the USB cable. Operation is not guaranteed if the communication unit is connected through a USB hub.
- * USB communication may rarely result in a communication error due to problems with compatibility when the USB controller is of the Open Host Controller Interface (OHCI) type. In the case a problem with compatibility has occurred, either use a Universal Host Controller Interface (UHCI) type of USB controller, or use infrared communication.

- (2) Attach the watch to the communication unit.
- (3) The watch will enter the communication mode (USB communication state) if the watch body is properly connected to the communication unit.

USB Communication Display
(Transfer Standby Display)



B. Sending and Receiving Data

The operations for sending and receiving data are performed with the software provided using a personal computer (AQUALAND GRAPH Nx or CAPgm). Refer to the AQUALAND GRAPH Nx or CAPgm manual contained on the CD-ROM provided for further details.

4. Data Communication Between Watches

If your friend or acquaintance has a CYBER AQUALAND Nx (Movement No. D71*) or CYBER AQUALAND (Movement No. D70*), data can be transferred between watches by using the infrared communication function. Data that can be transferred between watches is indicated below.

- Time settings (time, date, time difference from UTC, daylight savings time)
- Alarm settings (set time)
- Dive alarm (depth alarm, dive time alarm) settings
- Anniversary data (graphic)

Following data transfer, the watch settings of the receiving watch change according to the watch settings of the sending watch.

* Time and alarm settings can also be transferred between other watches equipped with an infrared communication function that complies with IrWW standards.

Procedure

Refer to part "1. Infrared Communication", "B. Infrared Communication Mode Operating Procedure" of the previous section for an explanation of the procedure for calling up each display.

- (1) Switch the watch that is to receive data to the reception standby display of the data you want to receive.

* In the case of time or alarm data, select the "TIME/ALM → Receive" menu, and in the case of dive alarm or anniversary data, select the "toWATCH → WaitDATA" menu.

- (2) Switch the watch that is to send data to the transmission display of the data you want to send (last display of the menu).

- (3) Press the upper right button (B) or the EL light button once of the sending watch after aligning the respective infrared transmission/reception units of the

sending and receiving watches. A sound is made by both the sending and receiving watches once data transfer begins. There is no sound made by the receiving watch if data transfer has failed (in the case of transferring data using CYBER AQUALAND or CYBER AQUALAND Nx).

- (4) Pressing the lower left button (D) for at least 2 seconds and then released on both the sending and receiving watches returns the watches to the time mode of the standard mode.

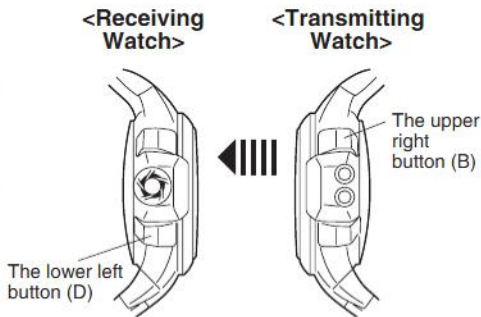

* One set of anniversary data (graphic) is sent per transmission. The anniversary graphic that will be sent changes each time the upper left button (C) is pressed during the Annivers (Anniversary Data Transmission) display.

* When sending time setting data, if the time difference zone (time difference from UTC) of the sending watch is not present in the receiving watch, a temporary location named "IrWW" is created in the receiving watch, and that location is corrected to the same time as the time of the sending watch.

The location "IrWW" cannot be displayed on the personal computer ("CAPgm" software). After setting the various watch settings on "CAPgm" and sending those settings to the watch, the location "IrWW" is deleted automatically.

All Reset

The time, date and all other watch settings are returned to their initial (default) settings when the all reset procedure is performed. Perform this all reset procedure in the following cases.

- There is an error in the watch display
- When charging the watch after it has stopped completely as a result of being insufficiently charged

Even if the all reset procedure is performed, location settings (displayed locations, names of locations), diving logs, daily graphics and anniversary graphics that have been set by the user in the PC remain without being deleted. However, it should be noted that only diving data acquired prior to performing the all reset procedure on the day the all reset procedure is performed may be deleted.

Procedure

- (1) Simultaneously press and then simultaneously release the lower right button (A), upper right button (B), upper left button (C) and lower left button (D).
 - All of the display elements on the watch are displayed after an alarm sounds and "INITIALIZE" is displayed.
- (2) Press any of the buttons once while all the display elements are displayed.
 - The watch displays the time mode of the standard mode after "LOADING" is displayed.

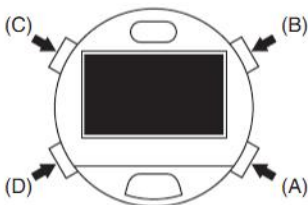

This completes the all reset procedure. Correctly reset the time and date as well as other modes after performing the all reset procedure.

- * When the All-Reset procedure is performed, <Current Log Counter in watch (Total number of Dives)> is reset to zero. If you want to continue counting from the previous log number, re-enter the previous log number for <Your Current Log Number> with the CAPgm software provided.
- * Although an alarm sounds every second while all of the display elements of the watch are displayed, this is not a malfunction.
- * If all of the display elements are not displayed after performing step (1) of the procedure (such as when the alarm continues to sound without the display changing), repeat step (1) of the procedure.
- * The watch automatically returns to the time mode of the standard mode if none of the buttons are pressed for about 2 minutes while all of the display elements are displayed after performing step (1) of the procedure. The all reset procedure is completed in this case as well.

Formatting Flash Memory

The following data recorded in the watch's flash memory is deleted when the flash memory is formatted.

- Location settings made on the PC (displayed locations, names of locations)
- Scuba diving and skin diving logs
- Daily and anniversary graphics



CAUTION

Formatting flash memory is performed when the flash memory has happened to become damaged. Please note that incorrect use of this function can cause important diving and other data to be lost. Formatting flash memory is not required during the course of normal use of this watch. Please be aware that the manufacturer is not responsible for log data or other data having been lost as a result of a malfunction or other reasons.

Procedure

- (1) Press the upper right button (B) in the system monitor mode of the standard mode to switch the watch to the Flash Memory Status Display.
- (2) Formatting of flash memory begins when the upper right button (B) is pressed while pressing the upper left button (C) simultaneously for at least 2 seconds and then releasing.
 - "Format" is displayed while formatting is in progress, after which "Done" is displayed when formatting is completed.



* Although location settings made on the PC and daily graphic data may be displayed for a while after formatting flash memory, this is only the result of the watch displaying data it has temporarily stored in memory. In actuality, data is deleted from flash memory. Temporarily displayed location settings and graphic data are not displayed after switching to the communication mode or low power mode and the switch back to the standard mode (after reloading the data from the flash memory.).

Accessory Software

The CD-ROM provided with the watch contains two application software programs entitled, "AQUALAND GRAPH Nx" and "CAPgm".

AQUALAND GRAPH Nx

This application software is used for editing and managing diving log and profile data.

CAPgm

This application is for making various watch settings on a personal computer.

* Refer to the respective manuals contained on the CD-ROM for further details on how to use AQUALAND GRAPH Nx and CAPgm.

* Acrobat Reader is required to view the above two manuals and other information. If Acrobat Reader is not installed in the PC you are using, install Acrobat Reader from the CD-ROM provided.



CAUTION

* The CD-ROM provided may be required for future upgrades or reinstallation. Store it in a safe location so that it is not damaged or lost. A replacement CD-ROM is available for a fee if the original CD-ROM should happen to be damaged or lost.

* Please be aware that the manufacturer is not responsible for loss or damage of program data, lost revenues or demands for compensation as a result of using the software provided.

1. Operating Environment

The following personal computer operating environment is required for using "AQUALAND GRAPH Nx" and "CAPgm".

1) **Personal Computer**

Personal computer capable of operating with Windows 98, Windows 98SE, Windows Me, Windows 2000 or Windows XP (Pentium II 450 MHz or higher recommended)

2) **Operating System (Compatible OS)**

Windows 98, Windows 98SE, Windows Me, Windows 2000, Windows XP

3) **Minimum Operating Memory**

In accordance with the recommended memory of each OS (minimum 128 MB recommended)

4) **Hard Disc**

A minimum of 15 MB of available space in the Windows directory and a minimum of 10 MB of available space in the installation directory are required for installation. A minimum of 50 MB of available space is required for starting up the program (minimum of 100 MB recommended).

5) **Display**

Color display having resolution equivalent to Super VGA (800 × 600, 256 colors) or better (High Color-compatible display recommended)

6) CD-ROM Drive (Required for Installation)

7) Infrared Communication Port or USB Port

* A communication unit (sold separately) is required for data communication using the USB communication interface.

8) Printer

A printer compatible with your personal computer and a printer driver for use with the operating system compatible with that printer are required for printing out graphs and other data.

9) Web Browser

A web browser is required for HTML preview. Internet Explorer Ver. 4.0 or later is required for the web browser (the display may not be shown properly if other web browsers are used).

* The Web Browser must be correlated with "HTML" files by file correlation.

<When Registering Animated Images in an Album>

- Microsoft Direct X 8.0 or later must be installed.

* "Direct X" is available at Microsoft web Download page.

- The following file formats are supported for animated images.

Moving Picture Experts Group 1 (MPEG-1)

Audio-Video Interleaved (AVI)

2. Installing AQUALAND GRAPH Nx (Diving Data Management Software)

Install AQUALAND GRAPH Nx from the CD-ROM provided by following the procedure described below.

- (1) After confirming that the personal computer has started up properly, end all applications, including antivirus programs currently running.

* The user must login to Windows as an Administrator in the case of installing the software with Windows 2000 or Windows XP.

- (2) Place the CD-ROM provided in the CD-ROM drive of the PC. The software installation menu is displayed automatically.

If the installation menu is not displayed, double-click on "install.exe" contained on the CD-ROM inserted into the CD-ROM drive to display the installation menu.

- (3) Click on "Install AQUALAND GRAPH Nx". Installation begins and the screen shown at right is displayed.



- (4) Confirm the contents and then click on "NEXT" to display the screen shown at right.



- (5) If you want to change the directory where the applications are installed, click on "Browse" and change to the desired directory. Confirm the contents and click on "NEXT" to install the applications. The screen shown at right is then displayed.



- (6) Click on "Finish" to complete the installation procedure.

3. Installing CAPgm (Watch Setting Software)

* Installation of "CAPgm" is not required if you are using the existing "AQUALAND GRAPH 2001" software for CYBER AQUALAND (Movement No. D70*). Since the "CAPgm" software installed simultaneously with "AQUALAND GRAPH 2001" can continue to be used, only install "AQUALAND GRAPH Nx".

Install CAPgm from the CD-ROM provided by following the procedure described below.

- (1) After confirming that the personal computer has started up properly, end all applications, including antivirus programs currently running.
* The user must login to Windows as an Administrator in the case of installing the software with Windows 2000 or Windows XP.
- (2) Place the CD-ROM provided in the CD-ROM drive of the PC. The software installation menu is displayed automatically.
If the installation menu is not displayed, double-click on "install.exe" contained on the CD-ROM inserted into the CD-ROM drive to display the installation menu.

- (3) Click on "Install CAPgm" to begin installation. The screen shown at right is displayed.



- (4) After confirming the contents, click on "NEXT". The screen shown at right is displayed.



- (5) If you want to change the directory where the software will be installed, click on "Browse" and change to the desired directly. Confirm the contents and click on "NEXT" to install the software. The screen shown at right is then displayed.



- (6) Click on "Finish" to complete the installation procedure.

4. Startup and Ending AQUALAND GRAPH Nx and CAPgm

A. Startup of AQUALAND GRAPH Nx and CAPgm

Click on the Start button in the task bar and then select Program, CITIZEN AQUALAND GRAPH Nx and then AQUALAND GRAPH Nx or CITIZEN CAPgm and then CAPgm in that order to start up the respective application.

B. Ending AQUALAND GRAPH Nx and CAPgm

Either click on the [X] button in the upper right corner of the main window or select [EXIT (X)] from the pull-down menu after selecting the [Files (F)] menu (or the [CAPgm (C)] menu in the case of CAPgm), to end the respective application.

Communication Unit

The communication unit is sold separately. The communication unit also features a watch charging function. The charging specifications (including time required to charge the watch, number of charges and so forth) and charging procedure of the communication unit are the same as those of the charger provided.



CAUTION Handling of Communication Unit

The communication unit is composed of precision electronic components. Please handle with care.

- Do not allow water to contact the communication unit or allow it to become wet. It is not of water resistant construction. In addition, entrance of sand, dust or other debris inside the communication unit can cause a malfunction. Particular caution is required in the case of using the communication unit outdoors. Make sure that the watch is not wet when placing it in the communication unit.
- When transporting the communication unit, always make sure to place it in its special-purpose trunk or place it in a bag wrapped in cloth or sponge that prevents the passage of electricity. Carrying the communication unit unprotected can cause generation of heat or the size AA alkaline batteries inside the unit to become worn down due to shorting between the terminals. When storing at home, be careful so that the terminals of the communication unit are not shorted due to contact with metal.
- Use and store the communication unit within a temperature range of +10°C to +40°C (50°F to 104°F), and humidity range of 20% to 80% (with no condensation of moisture). Avoid storing and using in environments subject to sudden changes in temperature.
- Avoid storing and using the communication unit in locations subject to direct sunlight or high levels of sand and dust. Do not allow it to remain inside an automobile in particular.
- Do not attempt to disassemble or modify the communication unit. This can cause a malfunction.
- Do not use the communication unit in close proximity to a television or radio. This can cause reception interference.
- Do not connect the communication unit to other brands of watches or other models of Citizen watches. This communication unit is to be used exclusively with CYBER AQUALAND Nx (Movement No. D71*).
- Only use the USB cable provided. The use of other cables can result in the occurrence of electromagnetic interference or other detrimental effects.
- Do not drop the communication unit or subject it to strong impacts. This can cause it to crack and malfunction.
- Please be aware that the manufacturer is in no way responsible for damages, lost profit or any other demands from a third party incurred as a result of use of this unit.
- Also be aware that the manufacturer is in no way responsible for damages, lost profit or any other demands from a third party incurred as a result of repairs or malfunction of this unit.

1. Names and Functions of Components

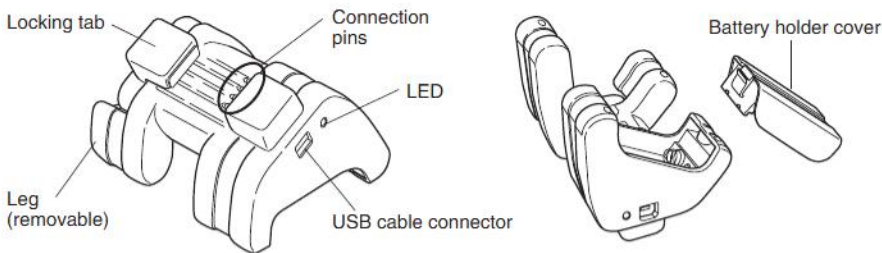

LED (Light Emitting Diode)

This indicates that the communication unit is in the charging state. When the watch is attached to the communication unit, the LED lights and charging begins. The LED remains lit during charging and goes out when charging is completed.

USB Cable Connector

This connector is for connecting the communication unit and a personal computer with the USB cable.

Connection Pins

These pins are for connecting with the charging or data transfer pins of the watch. There are four connections pins. The two center pins are connected to the charging or data transfer pins of the watch, while the two outside pins are connected to the watch case.

Locking Tab

This tab is for holding and locking the watch to the connection pins.

Battery Holder Cover

The battery holder cover is opened to install the size AA alkaline batteries. 2 pcs. of size AA alkaline batteries are installed in the communication unit body and 2 pcs. of size AA alkaline batteries are installed inside the battery holder cover.

Leg (Removable)

The leg can be removed when attaching watch models having a metal band to the communication unit.



WARNING

While removed, keep the leg and the battery holder cover out of the reach of children to prevent accidental swallowing.

2. Using the Communication Unit

A. Installing Batteries

- (1) Remove the battery holder cover on the bottom of the communication unit. The battery holder cover is removed by lifting up the tab while pushing in the direction of the arrow (OPEN).
- (2) Install 2 pcs. of size AA alkaline batteries each (total of 4 pcs. of size AA alkaline batteries) in the communication unit and battery holder cover while properly aligning their polarity.
- (3) Attach the battery holder cover.

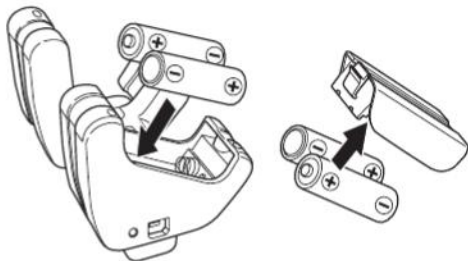
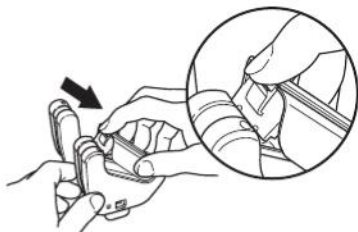

- * Securely attach the battery holder cover. If not attached securely, there may be insufficient contact with the size AA alkaline batteries.
- * When removing the battery holder cover, be careful not to damage your nail.
- * The size AA alkaline batteries in the communication unit will gradually become worn down even when not charging. It is recommended to remove the size AA alkaline batteries from the communication unit when not charging the watch for a long period of time.

B. Attaching and Removing the Watch

- (1) Fully open the locking tab on the left side of the communication unit.
- (2) Attach the watch to the communication unit so that the two center connection pins of the four connection pins of the communication unit contact the two terminals at the 3:00 position of the watch (gold colored).

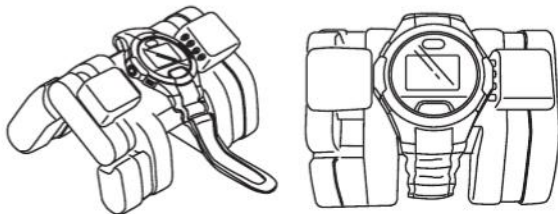

(3) Fully open the locking tabs of the communication unit and remove the watch.

- * When using the communication unit to charge the watch for the first time, the Install Wizard of the USB driver is displayed on the personal computer display when the communication unit is connected to the personal computer. Refer to "3. Installing the USB Driver" for information on installing the USB driver.
- * When attaching or removing the watch to or from the communication unit, make sure to fully open the locking tab of the communication unit. Attempting to attach or remove the watch without the locking tab fully open can cause the connection pins to become worn resulting in poor connection.
- * If the metal band of your watch is too short so that the watch cannot be attached to the communication unit, remove the communication unit leg (removable) and fit the watch onto the communication unit by passing it over the location where the stand was removed to attach it to the communication unit.

3. Installing the USB Driver

In the case of performing data communication with a personal computer using the communication unit, a USB driver must be installed in the personal computer to be used in advance. Install the USB driver from the CD-ROM provided with the watch by following the procedure described below. The procedure differs slightly depending on the compatible OS.

* The display screens used in this explanation differ depending on the language and version of the OS.

Windows98 or Windows98 SE:

- (1) Confirm that your personal computer has started up normally.
- (2) End any applications that are currently running on the PC.
- (3) Place the CD-ROM provided in the CD-ROM drive of the PC. If the AQUALAND GRAPH Nx installation menu is displayed at this time, click on the "EXIT" button to close this menu.
- (4) If the communication unit is connected to the USB port of the PC, a message is displayed on the PC indicating that new hardware has been detected and that the PC is searching for the required application software.

Once this check of new hardware is completed, the "Add New Hardware Wizard" is displayed.



- (5) After confirming the contents, click on "NEXT" to display the screen shown at right.



- (6) Check that "Search for the best driver for your device" has been selected and then click on "NEXT". The display changes to the screen shown at right.



- (7) Select "CD-ROM drive" and click on "NEXT". The display changes to the screen shown at right.



- (8) Click on "NEXT" to begin installing the driver. When installation is completed, the display changes to the screen shown at right.



- (9) Click on "Finish" to display the screen shown at right.



- (10) Click on "YES". Windows is restarted and data can now be transferred using the USB interface.

Windows Me:

- (1) Confirm that your personal computer has started up normally.
- (2) End any applications that are currently running on the PC.
- (3) Place the CD-ROM provided in the CD-ROM drive of the PC. If the AQUALAND GRAPH Nx installation menu is displayed at this time, click on the "EXIT" button to close this menu.
- (4) If the communication unit is connected to the USB port of the PC, a message is displayed on the PC indicating that new hardware has been detected and that the PC is searching for the required application software.

Once this check of new hardware is completed, the "Add New Hardware Wizard" is displayed.



- (5) After confirming the contents, click on "NEXT" to install the suitable driver from the CD-ROM and display the screen shown at right.



- (6) Click on "Finish". Data can now be transferred using the USB interface.

Windows2000:

(1) Confirm that your personal computer has started up normally.

* In the case of installing the USB driver with Windows 2000, the user must login to Windows as an Administrator.

(2) End any applications that are currently running on the PC.

(3) Place the CD-ROM provided in the CD-ROM drive of the PC. If the AQUALAND GRAPH Nx installation menu is displayed at this time, click on the "EXIT" button to close this menu.

(4) If the communication unit is connected to the USB port of the PC, the screen at right is displayed.



Once the check for detecting new hardware has been completed, the "Found New Hardware Wizard" is displayed.



(5) After confirming the contents, click on "NEXT" to display the screen shown at right.



(6) Check that "Search for a suitable driver for my device" has been selected and then click on "NEXT". The display changes to the screen shown at right.

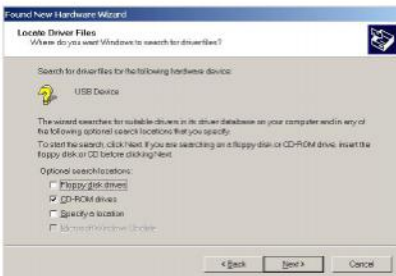

- (7) Confirm that "CD-ROM drives" is selected and then click on "NEXT". The display changes to the screen shown at right.



- (8) Confirm the contents and then click on "NEXT". The display changes to the screen shown at right.



- (9) Click on "Finish". Data can now be transferred using the USB interface.

WindowsXP:

- (1) Confirm that your personal computer has started up normally.

* In the case of installing the USB driver with Windows XP, the user must login to Windows as an Administrator.

- (2) End any applications that are currently running on the PC.
- (3) Place the CD-ROM provided in the CD-ROM drive of the PC. If the AQUALAND GRAPH Nx installation menu is displayed at this time, click on the "EXIT" button to close this menu.
- (4) If the communication unit is connected to the USB port of the PC, the screen shown at right is displayed.

Once the check for detecting new hardware has been completed, the "Found New Hardware Wizard" is displayed.



- (5) Confirm that [Install the software automatically (Recommended)] is selected and then click on "Next". The software is automatically detected and will start installing it .
Notice: It may take some time to detect the software.

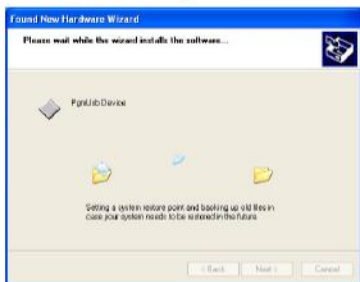

- (6) After installation is completed, the screen shown at right is displayed.
- (7) Click on "Finish". Data can now be transferred using the USB interface.



- * After installing the USB driver, remove the CD-ROM from the CD-ROM drive and keep it in a safe place.
- * Installation of the USB driver is only performed once before transferring data using the communication unit for the first time. It is no longer required to be installed prior to subsequent data transfer. However, when transferring data using the communication unit for the first time with a different PC, the driver must again be installed in that PC.

Troubleshooting

Problem	Possible Cause	Corrective Action	Reference
Display does not light	The watch is switched to No display in low power mode.	The display lights when the lower left button (D) is depressed for 2 seconds or more.	"Low Power Mode (Temporary Function)"
	The watch has stopped due to being insufficiently charged.	Perform the all-reset procedure with the watch placed on the charger or communication unit. * Check the section on "Unable to charge" if the display does not light after performing this procedure.	"Charge Level Indicator and Continuous Usage Time" "Charger: 3. Charging the Watch" "All-Reset"
Watch does not switch to dive mode	The water sensor check warning (CHK is displayed) has been activated.	After rinsing off any debris around the water sensor with water, carefully wipe off any excess moisture with a dry cloth.	"Warning Functions"
	The insufficient charge warning has been activated (BATT is displayed) due to the watch being insufficiently charged. (The watch will not switch to the dive mode if it is insufficiently charged.)	Sufficiently charge the watch by placing it on the charger or communication unit.	"Warning Functions" "Charge Level Indicator and Continuous Usage Time" "Charger: 3. Charging the Watch"
	A permanent error occurred during the previous dive (decompression diving).	The error will be reset after 24 hours.	"Warning Functions"
Dive mode cannot be terminated	If the water sensor remains activated by perspiration or other moisture in high-altitude environments where air pressure changes in a short period of time, and there is a change in air pressure of 1,000 hpa or more, the depth display does not return to 0.0 m (0 ft) and the dive mode may not be able to be canceled even after descending to a low altitude (on land).	The watch will return to the time mode or surface mode of the standard mode when the lower left button (D) is depressed for 10 seconds or more. * In this case as well, diving data until the time the dive mode was terminated remains in the log mode.	"Warning Functions"
Alarm does not sound and EL does not light	The insufficient charge warning has been activated (BATT is displayed) due to the watch being insufficiently charged. * The alarm will not sound if the alarm is set to "Silent".	Sufficiently charge the watch by placing it on the charger or communication unit.	"Warning Functions" "Charger: 3. Charging the Watch"

Problem	Possible Cause	Corrective Action	Reference
Faded display	Low ambient temperature. The display may fade in low-temperature environments.	The display will return to normal when the watch is returned to normal temperature. If you want to temporarily make the display darker when using in low-temperature environment, the contrast can be corrected in the time mode correction state of the standard mode.	"Using the Standard Mode: 1-B Setting the Time and Date"
Unable to charge (LED does not light)	The size AA batteries of the charger worn out.	Replace the size AA alkaline batteries with 4 pcs. of fresh ones.	"Charger"
	The watch is not properly installed on the charger or communication unit.	Properly reinstall the watch on the charger or communication unit so that the two center connection pins of the charger or communication unit contact the gold colored pins at the 3:00 position of the watch.	
	The connection pins of the charger or communication unit are soiled.	Wipe off the connection pins with a dry cloth.	
	The watch is already fully charged.	The LED goes out when the watch is fully charged.	
Log data is not recorded even when diving	The file error warning function (FILE is displayed) has been activated either before or during diving. * Log data may not be stored during diving if the file error warning function has been activated.	If "FILE" remains displayed even after diving, perform the garbage collection procedure in the system monitor mode.	"Warning Functions" "Using the Standard Mode: 7. Using the System Monitor Mode"
Log data is not correctly stored according to the actual dive (a portion of the log data display is flashing)	The watch did not switch to dive mode during diving.	Check the section on "Watch does not switch to dive mode".	"Warning Functions" "Charger: 3. Charging the Watch"
	Log data was not stored starting at some point during the dive when the insufficient charge warning function was activated as a result of the watch having become insufficiently charged. * If the insufficient charge warning function (BATT is displayed) is activated during diving, storage of log data is discontinued from that time on.	Always make sure to sufficiently charge the watch before diving.	

Problem	Possible Cause	Corrective Action	Reference
Slow in switching modes	As more and more flash memory is used, slightly more time may be required for the watch to switch modes and call up log data.	Perform the garbage collection procedure in the system monitor mode of the standard mode. When a large number of diving logs are stored in the watch, although slightly more time may be required to call up the display, this is not a malfunction.	"Using the Standard Mode: 7. Using the System Monitor Mode"
"CHK" remains displayed for a long period of time	The water sensor continues to be activated due to the presence of sand, debris, perspiration or other matter on the water sensor.	After rinsing off any debris around the water sensor with water, carefully wipe off any excess moisture with a dry cloth.	"Warning Functions"
"FILE" remains displayed	The amount of available space in flash memory is low.	Perform the garbage collection procedure in the system monitor mode of the standard mode	"Warning Functions" "Using the Standard Mode: 7. Using the System Monitor Mode"
	The watch is insufficiently charged and the ambient temperature is low. * The file error warning may be activated if the ambient temperature becomes low while the watch is insufficiently charged.	Sufficiently charge the watch by installing on the charger or communication unit.	"Warning Functions" "Charger: 3. Charging the Watch"
	Flash memory error.	Format the flash memory in the system monitor mode of the standard mode. If the problem is still not solved, consult the Citizen Service Center.	"Warning Functions" "Formatting Flash Memory"
"ERR" remains displayed for a long period of time • "ERR" is displayed when using the watch on land (excluding high altitudes at 3,000 m (10,000 ft) or more above sea level) • "ERR" continues to be displayed for a long period of time after completion of diving	There is an error in the pressure sensor. ("ERR" may be displayed at high-altitude locations of 3,000 m (10,000 ft) or more above sea level.)	Discontinue using the watch and consult the Citizen Service Center.	"Warning Functions"





Problem	Possible Cause	Corrective Action	Reference
Watch exhibits an abnormal display or operation (digital display is incorrect or alarm sounds continuously, etc.)	The display or operation of the watch may rarely become abnormal if the watch is mistakenly subjected to a strong impact or strong static electricity.	Perform the all-reset procedure. If the problem is still not corrected after performing the all-reset procedure, format flash memory after performing the all-reset procedure. If the problem is still not resolved, consult the Citizen Service Center.	"All-Reset" "Formatting Flash Memory"
Unable to install provided software	The OS of the personal computer or peripheral environment in which it is used is not supported by the software.	Recheck whether the environment of the personal computer being used is supported by the software.	"Accessory Software"
Data cannot be transferred using USB interface	The USB driver has not been installed.	Install the USB driver.	"Data Communication Functions" "Communication Unit"
	Properly connect the personal computer, communication unit and watch with the USB cable.	After first disconnecting all devices, try reconnecting them correctly.	
	The watch is in the low power mode.	The low power mode can be cancelled by simultaneously pressing the lower right button (A) and lower left button (D) for 2 seconds or more.	"Low Power Mode (Temporary Function)"
	Interface settings are incorrect during data reception.	Change the interface used during data reception to "USB".	Refer to the manuals for each of the software contained on the CD-ROM.
Data cannot be transferred by infrared interface	The watch is not set to the data transfer display of the infrared communication mode.	Set the watch display to the data transfer display of the infrared communication mode.	"Data Communication Functions: 1. Infrared Communication"
	The personal computer is not equipped with an infrared communication function.	Data cannot be transferred by infrared transfer. Use the USB interface to transfer data.	"Data Communication Functions: 2. Communication by USB Interface"
	The watch and the infrared reception unit of the personal computer are not properly positioned. In addition, the corresponding infrared reception units of the watch and personal computer have moved away from each other during the course of communication.	Properly position the respective infrared transmission and reception units of the watch and personal computer, fix them in position and then try transferring data again.	"Data Communication Functions: 1. Infrared Communication"
	The interface setting during infrared reception is incorrect.	Change the interface used during data reception to "IrDA".	Refer to the manuals for each of the software contained on the CD-ROM.

Handling Precautions (for the watch)



WARNING Water Resistance Performance

This watch is water resistant to 200 meters. Although it can be used for air diving using an air tank (scuba diving), it cannot be used for saturation diving involving the use of helium gas.

Indication	Examples of Use				
	Case (case back)	 Minor exposure to water (washing face, rain, etc.)	 Moderate exposure to water (washing, kitchen work, swimming, etc.)	 Skin diving, marine sports	 Scuba diving using an air tank
AIR DIVER'S 200m	OK	OK	OK	OK	NO



CAUTION

- In order to maintain water resistance performance, have your watch inspected at a Citizen Service Center every one to two years, and have the gaskets, crystal or other components replaced as necessary.
- If moisture has entered the watch, or if the inside of the glass is fogged up and does not become clear for an extended period of time, do not leave the watch in that state, but immediately take the watch to a Citizen Service Center for inspection and repair.
- If sea water enters the watch, place the watch in a box or plastic bag, and immediately take it in for repair. Otherwise, pressure inside the watch will increase and parts (such as the glass and buttons) may come off.



WARNING Handling of Energy Storage Cell

- Do not attempt to remove the energy storage cell from the watch. If the energy storage cell must be unavoidably removed, place it in a location out of the reach of children to prevent accidental swallowing.
- If the energy storage cell is accidentally swallowed, contact a physician immediately and seek medical attention.



WARNING Only Use Specified Energy Storage Cell

- Never attempt to use an energy storage cell other than the energy storage cell used by this watch. Although the structure of the watch prevents the watch from operating if another battery is installed, if a silver battery or other type of battery is forcibly installed in the watch and the watch is attempted to be charged with that battery installed, the battery may rupture resulting in possible damage to the watch and physical injury. Always make sure to use the specified energy storage cell when replacing.



CAUTION Repairs

All parts of this watch, excluding the band, are to be repaired only at a Citizen Service Center. Please have all inspections and repairs performed at a Citizen Service Center.



CAUTION Keep your watch clean

- The case and band of the watch come in direct contact with the skin in the same manner as clothing. Metal corrosion as well as perspiration, dirt, dust and other unnoticed debris may soil the cuffs and other parts of your clothing. Try to keep the watch clean at all times.
- Wearing of this watch may cause a rash or itching of the skin in people with sensitive skin or depending on the wearer's physical condition. If you notice that your skin is affected by the watch, immediately stop wearing it and consult a physician.

<Cleaning the Watch>

- Use a soft cloth to wipe off dirt, perspiration and moisture from the case and crystal.
- Rinse off dirt from metal bands, plastic bands or rubber bands with water. Use a soft brush to remove any dirt or debris stuck between the gaps in metal bands.
- Avoid the use of solvents (such as thinner or benzine) as they may damage the finish.



CAUTION Precautions When Wearing the Watch

- Be careful while wearing the watch while holding an infant or child, by taking the watch off beforehand, to prevent injury or other accident.
- Be careful when engaged in vigorous exercise or work to prevent injury and accidents to yourself and others.
- Never wear the watch in a sauna or other locations where the watch can reach high temperatures since this can cause burns.



CAUTION Handling of the Band (Cautions when Putting on and Taking Off the Watch)

Depending on the structure of the band buckle, be careful not to injure your fingernails when putting on and taking off the watch.

<Temperatures>

The watch may not function or stop running if exposed to temperatures outside the range of 0°C to 50°C (32°F to 122°F). In addition, although the liquid crystal display may also become illegible outside this temperature range, it will return to normal when the watch is returned to normal temperatures.

- Correct water depth measurement values are not displayed at temperatures outside the range of +10°C to +40°C (50°F to 104°F).
- Data cannot be transferred outside the range of +10°C to +35°C (50°F to 95°F).

<Static Electricity>

Since the IC used in quartz watches is susceptible to static electricity, the display may become incorrect if the watch is subjected to intense static electricity like that generated by a television screen.

<Shocks>

Do not subject the watch to violent shocks such as that resulting from being dropped on the floor.

<Chemical Agents, Gases and Mercury>

Avoid using the watch in environments containing chemical agents and gases. If solvents such as thinner or benzine, as well as articles containing such substances (including gasoline, fingernail polish, cresol, bathroom cleaners and adhesives) become adhered to the watch, they can cause discoloration, deterioration and cracking. Use ample caution when handling chemicals. In addition, contact with mercury used in thermometers and so forth can cause the case and band to become discolored.

<Storage>

- When not using the watch for an extended period of time, carefully wipe off any perspiration, dirt or moisture from the watch and store in a location preferably free of high and low temperatures, high humidity.

Specifications

1. Watch

- Movement No. : D710 (meter specifications)/D716 (feet specifications)
- Crystal oscillation frequency: 32,768 Hz (Hz = no. of oscillations per second)
- Watch operating temperature range: 0°C to +50°C (32°F to 122°F)
- Timekeeping accuracy: ±20 seconds per month on average (when wearing at normal temperatures of +5°C to +35°C / 41°F to 95°F)
- Depth gauge accuracy: ± (3% of displayed value + 0.3 m (1 ft)) (when used at a constant temperature)
 - * Guaranteed accuracy temperature range: +10°C to +40°C (50°F to 104°F) (accuracy of water depth measurement is affected by changes in ambient temperature)
- Water depth measurement range: 1.0 m (4 ft) to 80.0 m (266 ft)
- Water temperature measurement accuracy: Displayed value ±3°C (6°F)
- Modes and Display Functions
 - Standard Mode
 - Time: Hours, minutes, seconds, location, month, date, day, year (during correction only), charge level indicator, dive condition, daily graphic (must be set with a PC)
 - Travel time: Month, date, hours, minutes, seconds, location, time difference with UTC time and time in time mode
 - Destination timer: Time remaining until arrival, arrival time (location, month, date, day, hours, minutes)
 - Alarm: Alarm time (hours, minutes)
 - Chronograph: Hours, minutes, seconds, 1/100 seconds, split time (100 hour clock)
 - Timer: Minutes, seconds (set up to 99 minutes in 1 minute units)
 - System monitor: Charge level indicator, display of flash memory usage status
 - Dive Plan Mode:
AIR/NITROX setting, oxygen concentration (O₂%) setting, dive number, body nitrogen level graph, no-decompression limit time, depth alarm (setting of depth and number of times alarm sounds), dive time alarm (setting of dive time)
 - Scuba Diving Log Mode:
Dive condition mark, total no. of dives, dive date, dive number, set oxygen concentration (during NITROX diving), surface interval time, in time, out time, dive time, minimum water temperature, decompression dive record, maximum depth, average depth, profile log
 - Skin Diving Log Mode:
Dive date, dive number, maximum depth, time in, time out, dive time, previous maximum depth and date recorded
 - Dive Mode
Current time, current depth, dive time, maximum depth, no-decompression limit time, water temperature, body nitrogen level graph, safety stop graph, safety stop time, decompression stop instructions display, decompression stop graph, body partial pressure of oxygen (PO₂), set oxygen concentration (O₂%)
 - Surface Mode
Elapsed time after diving (max. 24 hours), no fly time

- Infrared communication mode
- Low power mode:
 - Time display/date display/no display
- Other Additional Functions:
 - Dive Computer Functions
 - Decompression calculation algorithm: DCIEM (Canada)
 - NITROX diving compatibility (set oxygen concentration: 22% to 50%, set in 1% units)
 - High-altitude diving compatibility (up to 3,000 m (10,000 ft) above sea level)
 - EL illumination
 - Water sensor
 - Warning functions

Insufficient charge warning, file error warning, abnormal pressure detection error warning, water sensor check warning, ascent rate warning, abnormal depth warning, exceed maximum depth warning, decompression diving warning, decompression diving error, permanent error warning, permanent error, PO₂ limit warning, PO₂ limit error, oxygen toxication time warning, oxygen toxication time error
 - Data communication function: Data communication using infrared or USB interface (data transfer with personal computer and data transfer between watches)
 - * Data communication operating temperature range: +10°C to +35°C (50°F to 95°F)
- Power source: Energy Storage cell, 1 pc.
 - (Rechargeable by charger or communication unit)
- Continuous operating times:
 - From fully charged to activation of insufficient charge warning: Approx. 1 month
 - From insufficient charge warning to low power mode: Approx. 2 days
 - From low power mode to stopped: Approx. 3 days
 - * Refer to “Charge Level Indicator and Continuous Usage Time” for information on the operating conditions of continuous operating times.

2. Charger

- Model: CMUT-04
- Application: Watch charging
- Operating and storage conditions:
 - Temperature: +10°C to +40°C (50°F to 104°F)
 - Humidity: 20% to 80% (no condensation of moisture)
- Power supply: Size AA alkaline batteries (LR-6), 4
- Current consumption: Max. 20 mA
- Size: Approx. 8.3 (W) × 6.0 (D) × 6.3 cm (3.2 (W) × 2.3 (D) × 2.4 inch)
- Weight: Approx. 107 g (excluding size AA alkaline batteries)

3. Communication Unit (Sold Separately)

- Model: CMUT-02
- Application: Watch charging and data communication using USB cable
- Operating and storage conditions:
 - Temperature: +10°C to +40°C (50°F to 104°F)
 - Humidity: 20% to 80% (no condensation of moisture)
- Power supply:
 - During charging: Size AA alkaline batteries (LR-6), 4
 - During data communication: Power supplied through USB cable
- Current consumption:
 - During data communication: Max. 30 mA
 - During charging: Max. 20 mA
- Size: Approx. 10.2 (W) × 9.1 (D) × 6.9 (H) cm (4.0 (W) × 3.6 (D) × 2.7 (H) inch)
- Weight: Approx. 125 g (excluding size AA alkaline batteries)

* Specifications are subject to change without notice.