

<b>Contents</b>	
<b>1. About This Product</b>	Q & A for the world time function..... 90
Handling cautions..... 72	<b>4. How to Set the Time (Radio Signal Reception)</b>
Features..... 76	Setting the time and date
Display and button operation..... 78	by receiving a radio signal..... 91
How to use Button A and B..... 80	About reception conditions..... 93
Crown..... 81	How to check the reception results..... 96
<b>2. Before Use</b>	<b>5. Solar Charging Function</b>
Before use..... 82	About charging..... 102
<b>3. World time function</b>	About energy..... 104
How to use the world time function..... 84	<b>6. To Preserve the Quality of Your Watch</b>
How to select the time zone (How to display the local time around the world) ... 86	Daily care..... 106
Time zone display and time difference table..... 88	Performance and type..... 106
	Water resistance..... 107
	Magnetic resistance..... 108

Thank you very much for choosing a SEIKO watch.  
For proper and safe use of your SEIKO watch,  
please read carefully the instructions in this  
booklet before using.

※ Length adjustment service for metallic bands is available at the retailer from whom the watch was purchased or SEIKO CUSTOMER SERVICE CENTER. The service may also be available on a chargeable basis.  
The service may also be available at other retailers, however, some retailers may not undertake the service.

Band..... 110	<b>1</b>
Special clasps..... 112	<b>2</b>
Power source..... 116	<b>3</b>
Lumibrite..... 117	<b>4</b>
After-sale service..... 118	<b>5</b>
<b>7. Troubleshooting</b>	<b>6</b>
How to conduct manual reception (Receiving a radio signal manually) ... 119	<b>7</b>
When the watch is unable to receive radio signals..... 121	<b>8</b>
Preliminary position..... 126	
How to correct the preliminary positions..... 127	
At trouble..... 130	
In case of an abnormal movement..... 134	
<b>8. Specifications</b>	
Specifications..... 135	

## Handling cautions

1

About This Product

### ⚠ WARNING

To indicate the risks of serious consequences such as severe injuries unless the following safety regulations are strictly observed.

- Immediately stop wearing the watch in following cases.
  - If the watch body or band becomes edged by corrosion etc.
  - If the pins protrude from the band
- ※ Immediately consult the retailer from whom the watch was purchased or SEIKO CUSTOMER SERVICE CENTER.
- Keep the watch and accessories out of the reach of babies and children.

Care should be taken to prevent a baby or a child accidentally swallowing the accessories. If a baby or a child swallows the battery or accessories, immediately consult a doctor, as it will be harmful to the health of the baby or child.
- Do not remove the secondary battery from the watch.
  - ※ About the secondary battery → Power source P.116Replacement of the secondary battery requires professional knowledge and skill. Please ask a watch retailer for replacement of the secondary battery.

Installation of an ordinary silver oxide battery can generate heat that can cause bursting and ignition.

72

### ⚠ CAUTIONS

To indicate the risks of light injuries or material damages unless the following safety regulations are strictly observed.

- Avoid wearing or storing the watch in the following places.
  - Places where volatile agents (cosmetics such as polish remover, bug repellent, thinners etc.) are vaporizing
  - Places where the temperature drops below 5°C or rises above 35°C for a long time
  - Places of high humidity
  - Places affected by strong magnetism or static electricity
  - Dusty places
  - Places affected by strong vibrations
- If you observe any allergic symptoms or skin irritation  
Stop wearing the watch immediately and consult a specialist such as a dermatologist or an allergist.
- Other cautions
  - Replacement of the metal band requires professional knowledge and skill. Please ask a watch retailer for replacement of the metal band, as there is a risk of hand or finger injury and fear of losing parts.
  - Do not disassemble or tamper with the watch.
  - Keep the watch out of the reach of babies and children. Extra care should be taken to avoid risks of any injury or allergic rash or itching that may be caused when they touch the watch.
  - When disposing of used batteries, follow the instructions of your local authorities.
  - If your watch is of the fob or pendant type, the strap or chain attached to the watch may damage your clothes, or injure the hand, neck, or other parts of your body.

1

About This Product

73

### ⚠ WARNING



**Do not use the watch in scuba diving or saturation diving.**

The various tightened inspections under simulated harsh environment, which are usually required for watches designed for scuba diving or saturation diving, have not been conducted on the water-resistant watch with the BAR (barometric pressure) display. For diving, use special watches for diving.

### ⚠ CAUTION



**Do not pour running water directly from faucet.**

The water pressure of tap water from a faucet is high enough to degrade the water resistant performance of a water resistant watch for everyday life.

1

About This Product

74

### ⚠ CAUTIONS



**Do not turn or pull out the crown when the watch is wet.**  
Water may get inside of the watch.

※ If the inner surface of the glass is clouded with condensation or water droplets appear inside of the watch for a long time, the water resistant performance of the watch is deteriorated. Immediately consult the retailer from whom the watch was purchased or SEIKO CUSTOMER SERVICE CENTER (listed on the end of a book).



**Do not leave moisture, sweat and dirt on the watch for a long time.**

Be aware of a risk that a water resistant watch may lessen its water resistant performance because of deterioration of the adhesive on the glass or gasket, or the development of rust on stainless steel.



**Do not wear the watch while taking a bath or a sauna.**  
Steam, soap or some components of a hot spring may accelerate the deterioration of water resistant performance of the watch.

1

About This Product

75

## Features

1

About This Product

This solar radio-controlled watch is equipped with the world time function.  
 • By selecting a time zone, the watch can automatically display the local time in a different time zone around the world.

• The watch indicates the precise time by automatically receiving radio signals on official standard frequencies. (The watch can receive official standard frequencies from Japan, China, and the U.S.A.)

**World Time Function.....** By selecting a time zone, the watch can display the local time in the selected time zone area.  
 → P.84

**Radio Signal Receiving Function...** The watch maintains the precise time by automatically receiving radio signals on official standard frequencies. Manual reception of radio signals is also possible. The watch can receive official standard frequencies from Japan, China, and the U.S.A (select the receiving station using the world time function).  
 → P.91

**Display Function of Radio Signal Reception Results...** The movement of the second hand indicates radio signal reception results (Yes/No).  
 → P.96

**Display Function of Radio Signal Reception Level.....** The movement of the second hand indicates the radio signal reception level during radio signal reception attempts. (only when the watch is receiving radio signals by manual operation.)  
 → P.119

**Solar Rechargeable Battery .....** A solar cell underneath the dial converts any form of light into "electrical energy" to power the watch and the power is stored in a secondary battery. Once fully charged, the watch continues to run for approximately six months.  
 → P.102

**Energy Depletion Forewarning Function...** The movement of the second hand indicates when the battery should be charged.  
 → P.104

**Power Save Function .....** The Power Save mode is activated when the watch is left without an adequate light source to reduce energy consumption.  
 → P.105

**Automatic Hand Alignment Function...** Affected by magnetism or other external sources, when the hand alignments are deviated, the watch automatically corrects the hand alignments.  
 → P.126

1

About This Product

76

77

## Display and button operation

1

About This Product

Main Watch

Minute hand

Hour hand

Second hand

Date

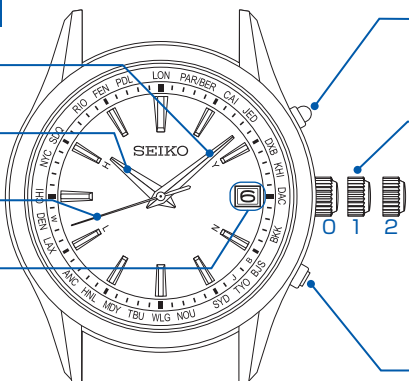

**Button A** → P.80

※ The operation method of the button varies with the function being used. Follow the instructions of each section of this booklet.

**Crown**

Normal position: How to select the time zone P.86  
 Checking the reception result P.96  
 Manual reception P.119  
 First click: Manual date setting P.124  
 Second click: Manual time setting P.122  
 Resetting the built-in IC P.134

※ If your watch has a screw lock type crown, keep it locked while you are wearing the watch.  
 → Crown P.81

**Button B** → P.80

※ The operation method of the button varies with the function being used. Follow the instructions of each section of this booklet.

**Display of Radio Wave Reception Level**

**[Manual reception]** → P.119

H··· High reception level (50-second position)

L··· Low reception level (40-second position)

N··· Unable to receive radio signals (20-second position)

**Standard Frequencies Transmitting Station Display**

Displays time zone in the Standard Frequencies Transmitting Station.

J···JJY (Japan)  
 B···BPC (China)  
 W···WWVB (The U.S.A)

**Display of Radio Wave Reception Result**

**[Checking the reception results]**

→ P.96

Y··· Reception Successful (10-second position).

N··· Reception failed (20-second position).

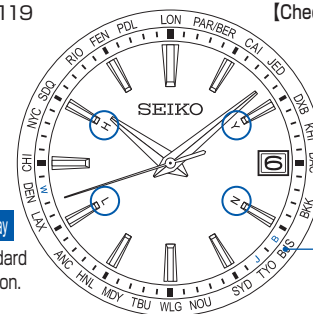

**Time Zone Display**

**[Time zone selection]**

→ P.86

City names··· 25 cities around the world

※ Indication on the bezel or positions of each item on the dial may vary depending on the model (design).

78

79

## How to use Button A and B

Buttons A and B are recessed in the watchcase to improve the design and to prevent erroneous operation. Please refer to the following figures for how to press the buttons.

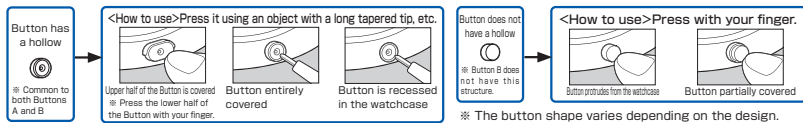

### ■ When pressing Buttons A and B at the same time

Make sure to confirm "How to use Buttons A and B" as shown above before pressing the buttons. First, press Button B, and press Button A while pressing Button B so as to press them successfully.

- **Both Buttons A and B have a hollow**  
Press the buttons using an object with a long tapered tip holding the watch as shown in the figure so that the watch does not move.
- **Button A does not have a hollow, and Button B has a hollow**  
Press Button A with your finger and Button B using an object with a long tapered tip.



※ Press the buttons on a soft cloth or the like before operation in order to prevent damage to the watch.

## Crown

There are two types of crowns, a normal crown and a screw-lock crown. Check the crown on your watch.

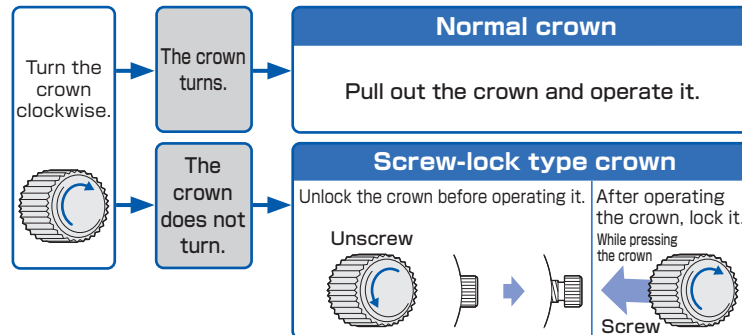

- ※ If your watch has a screw-lock crown, the crown screws into the watch to prevent malfunction and increase water resistance.
- ※ Be careful not to screw the crown in by force as it may damage the slots of the crown.

## Before use

### 1. Checking the charging status

When the movement of the second hand shows an energy depletion state, the battery requires charging.

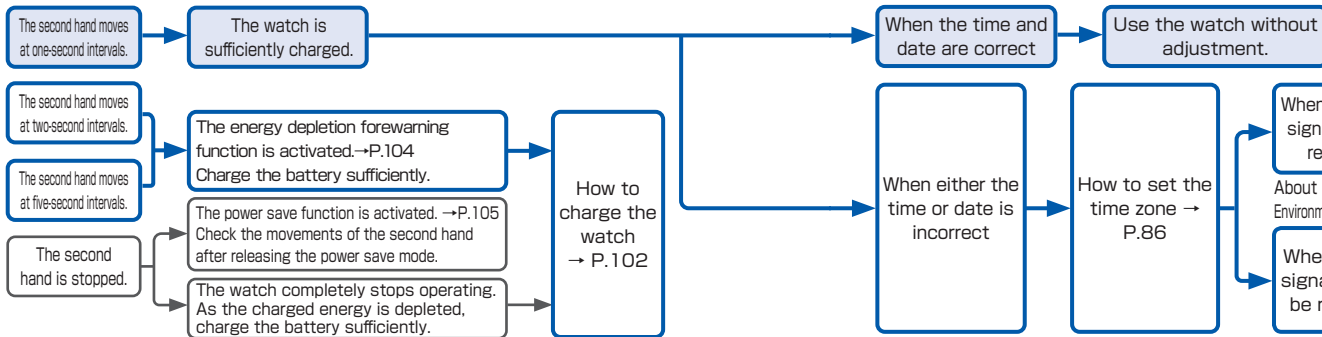

- ※ If the second hand does not move at one-second intervals even after fully charging the battery → "Charging the solar battery" in Troubleshooting on P.131

### 2. Checking the time and date

- ※ The hands of this watch cannot be moved by turning the crown. When adjusting the time and date, refer to the following pages.

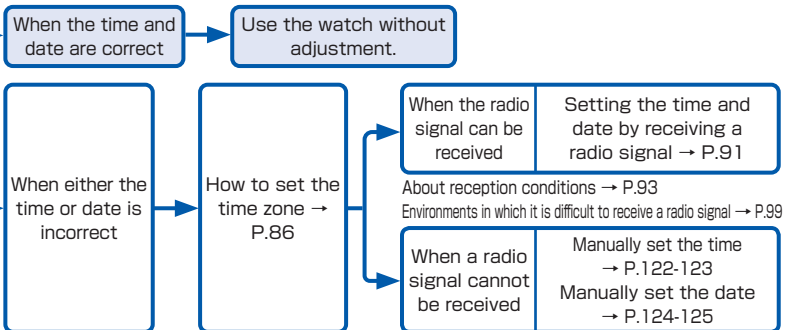

- ※ If either the time or date is incorrect, even though a radio signal was received successfully → "Misalignment of the time and hand positions" in Troubleshooting on P.132 and "Misalignment of the date" in Troubleshooting on P.133

## How to use the world time function

### World time function

- The local time in a different time zone can be displayed by selecting a time zone among 25 regions around the world.

In the Time Zone Setting mode, the second hand indicates the selected time zone.

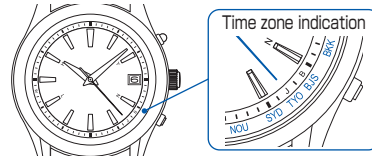

- If the time zone is set to Japan, China, and the U.S.A, the watch displays the precise time and date by receiving radio signals, provided that the watch is within the radio signal reception range.

※ The watch is unable to receive radio signals outside the reception range.  
→ About reception conditions P.93

→ How to select the time zone P.86

→ Time zone display and time difference table P.88

3

World time function

84

Example: How to display the local time in Honolulu (How to set the time zone to HNL (Honolulu))  
When the time zone is selected, the date is automatically adjusted in conjunction with the time.

<Before time zone setting>



<After time zone setting>



Local time in Japan: 6 th., 10 o'clock, 8 minutes, and 42 seconds

Local time in Honolulu: 5 th., 15 o'clock, 8 minutes, and 42 seconds

3

World time function

85

## How to select the time zone (How to display the local time around the world)

Within 10 seconds after procedure 1. is completed, start the operation of procedure 2..

※ If the watch is left untouched for 10 seconds after the second hand stops, the watch automatically returns to the TIME display mode. If this happens, restart the operation from procedure 1..

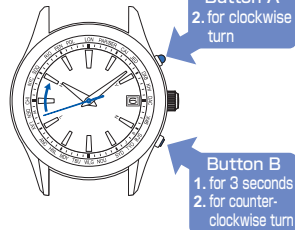

※ To press Button B, use an object with a long tapered tip. → P.80

3

World time function

86

1. Keep pressing down Button B (for 3 seconds) until the second hand stops.

▶ The second hand starts to move and stops pointing to the currently selected time zone.

2. Within 10 seconds after carrying out procedure 1., press Button A or B to set the second hand to point at the target time zone index.

▶ With each pressing of the button, the second hand moves to the adjacent time zone index.

The radio signal transmitting station can be changed by selecting the time zone. When selecting a time zone for regions other than the radio signal reception ranges, the radio signal reception function will not work.

※ When setting Daylight Saving Time (DST), add one hour to the time zone of a desired area.

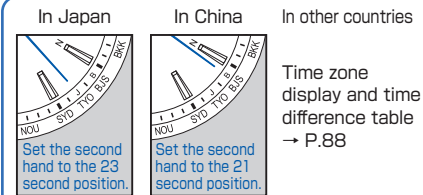

3. Wait for ten seconds after the movement of the hour and minute hands stop. (The time zone adjustment mode is finished.)

▶ The second hand starts to move. The watch automatically adjusts the date as necessary.

※ While the date is moving, neither the buttons nor the crown can be operated.

3

World time function

87

## Time zone display and time difference table

In the Time Zone Setting mode, set the second hand to point at the target time zone index referring to the table below. To set Daylight Saving Time (DST), select the time zone index next to the target time zone (+ 1 hour).

※ The time zones with a △ mark are the time zones which should be selected while Daylight Saving Time (DST) is being observed in the time zone (- 1 hour).

※ Each indication may differ depending on the model (design) of the watch.

As of December 2017

Indication	Second hand positions	Names of representative cities	Time difference from UTC	Receivable radio signals
LON	0-second position	London	0 hours	—
PAR/BER	3-second position	Paris/Berlin	+1 hours	—
CAI	6-second position	Cairo	+2 hours	—
JED	8-second position	Jeddah	+3 hours	—
DXB	11-second position	Dubai	+4 hours	—
KHI	13-second position	Karachi	+5 hours	—
DAC	15-second position	Dhaka	+6 hours	—
BKK	18-second position	Bangkok	+7 hours	—
BJS	21-second position	Beijing	+8 hours	BPC
TYO	23-second position	Tokyo	+9 hours	JJY
SYD	25-second position	Sydney	+10 hours	JJY △
NOU	28-second position	Nouméa	+11 hours	—
WLG	30-second position	Wellington	+12 hours	—

Indication	Second hand positions	Names of representative cities	Time difference from UTC	Receivable radio signals
TBU	32-second position	Nuku'alofa	+13 hours	—
MDY	34-second position	Midway Islands	-11 hours	—
HNL	36-second position	Honolulu	-10 hours	—
ANC	38-second position	Anchorage	-9 hours	—
LAX	41-second position	Los Angeles	-8 hours	WWVB
DEN	43-second position	Denver	-7 hours	WWVB
CHI	45-second position	Chicago	-6 hours	WWVB
NYC	48-second position	New York	-5 hours	WWVB
SDQ	50-second position	Santo Domingo	-4 hours	WWVB △
RIO	53-second position	Rio de Janeiro	-3 hours	—
FEN	55-second position	Fernando de Noronha	-2 hours	—
PDL	57-second position	Azores	-1 hours	—

3

World time function

88

## What is a time zone?

Based on Coordinated Universal Time (UTC), the standard time commonly used is adopted by countries and regions around the world. The standard time is determined by each country or region, and the region where the same standard time is adopted is referred to as the time zone. Further, Daylight Saving Time (DST) is individually adopted in countries and regions.

### [What is UTC (Coordinated Universal Time)?]

UTC is the universal standard time coordinated through international agreement. It is used as the official time around the world. UTC is determined by adding a leap second to GMT (Greenwich Mean Time), which is determined through astronomical measurement in order to keep the precise time.

### [What is summer time (DST)?]

Summer time is Daylight Saving Time. Advancing the watch one hour to prolong daytime during longer daylight hours in summer. The adoption and duration of Daylight Saving Time (DST) varies depending on the country.

※ Time differences between regions and Daylight Saving Time may change due to circumstances of a country or region.  
 ※ In some regions, time zones that differ from UTC by half- or quarter-hour time differences are established. (For example, some parts of India.)

3

World time function

89

## Q & A for the world time function

Q: Will the watch be automatically set to the local time when it is moved to a place outside Japan in a different time zone?

A: The watch will not be automatically set to the local time if it is just moved to a place outside Japan in a different time zone. Select the time zone where you are when you are abroad. If you select the time zone, the watch is automatically set to the local time. (The time difference can be adjusted in increments of 1 hour.)

After selecting the time zone, if it is within the reception range of radio signals, you can leave the watch to receive the radio signal to set it to the precise time. (The radio signal transmitting station can be changed by selecting a time zone.)

Q: When returning to Japan from overseas, is the time automatically set to Japan time?

A: Just moving cannot adjust the Japanese local time. After selecting the time zone, radio signal reception is not performed. When wearing a watch in Japan, set to Japan time by use of the time zone adjustment function.

Q: The hands stop during operation of time zone setting, therefore, does a time lag occur?

A: The internal circuit stores the time, therefore, no time lag occurs.

Q: When a time zone for regions out of the radio signal reception range is set, the watch will not receive a radio signal. How is the accuracy of the watch at that time?

A: The watch has an accuracy of a normal quartz watch in that case. (Monthly rate: ±15 seconds)

Q: How is adjustment made to a local time with a time difference of 15 minutes or 30 minutes?

A: The time can be adjusted on a 1 hour basis by use of the time difference adjustment function. When adjusting to a local time with a time difference of 15 minutes or 30 minutes.  
 → How to manually set the time P.122

3

World time function

90

## Setting the time and date by receiving a radio signal

### Mechanism of radio signal reception

The radio-controlled watch displays the precise time and date by automatically receiving and synchronizing itself with the radio signal of an official standard frequency. The standard frequency for time information comes from a "cesium atomic clock," which maintains the ultra-precision of a one-second difference about every 100,000 years.

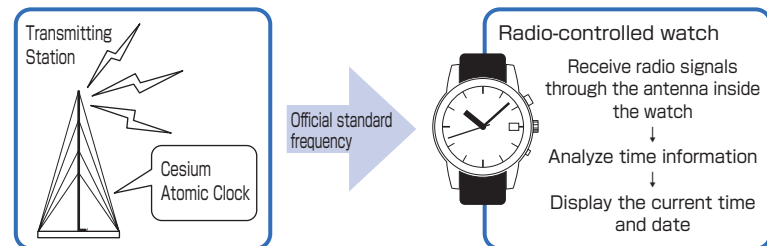

4

How to Set the Time (Radio Signal Reception)

91

## Automatic reception and manual reception

### Automatic reception

This watch sets the time and date by automatically receiving a radio signal at a fixed time. It automatically receives a radio signal before 2:00 AM, 3:00 AM and 4:00 AM.  
 ※ When the watch successfully receives a radio signal, it will stop automatic reception.

- Place the watch in a place where it can easily receive a radio signal such as near a window.
- While the watch is receiving radio signals, do not move it.  
 → To Improve radio signal reception P.98

### Manual reception

When this watch cannot automatically receive a radio signal due to a difficult receiving environment, it is possible to receive signals arbitrarily at any time.  
 → How to conduct manual reception P.119

- ※ If the time zone is set to a region other than Japan, China, and the U.S.A, the signal reception function will not work. → Time zone display and time difference table P.88
- ※ Radio Signal reception results depend on the receiving condition. → Environments in which it is difficult to receive a radio signal on P.99
- ※ This watch is unable to receive radio signals outside a reception range → About reception conditions on P.93
- ※ If either the time or date is incorrect, even though a radio signal was received successfully → "Misalignment of the time and hand positions" in Troubleshooting on P.132 and "Misalignment of the date" in Troubleshooting on P.133

## Radio signal reception range: China (BPC)

The reception range from the transmitting station is approximately 1,500 km (1,500 km radius of the transmitting station).

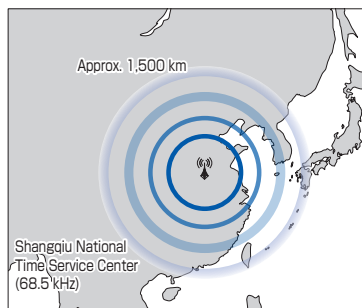

BPC is operated by NTSC.  
 Shangqiu National Time Service Center  
 Frequency: 68.5kHz

※ NTSC: National Time Service Center

- ※ The watch may be able to receive radio signals outside a reception range if the receiving conditions are favorable.
- ※ The watch may fail to receive radio signals depending on the reception conditions (weather, geographic locations, radio disturbances such as tall buildings, and orientation of the watch).  
 → Environments in which it is difficult to receive a radio signal P.99

## About reception conditions

This watch receives standard radio signals from Japan (2 stations), China, and the U.S.A. When you set the watch to each time zone, the official standard frequencies the watch receives will be automatically changed accordingly to the selected time zone. → How to select the time zone P.86

### Radio signal reception range: Japan (JJY)

The reception range from each transmitting station is approximately 1,000 km (1,000 km radius of each station).

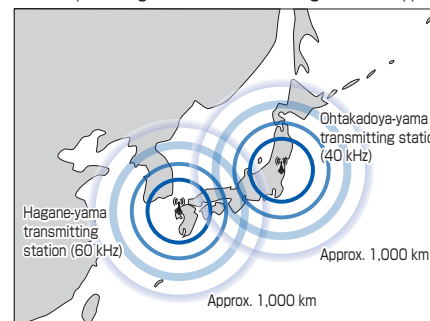

JJY is operated by the National Institute of Information and Communications Technology (NICT). JJY is transmitted from two stations in Japan. Each station transmits JJY in a different frequency.

Fukushima (Ohtakadoya-yama transmitting station: 40 kHz)  
 Kyushu (Hagane-yama transmitting station: 60 kHz)

※ NICT: National Institute of Information and Communications Technology

- ※ Whether the watch succeeds in receiving radio signals or not depends on the receiving conditions.  
 → Environments in which it is difficult to receive a radio signal P.99

## Radio signal reception range: the U.S.A (WWVB)

The reception range from the transmitting station is approximately 1,500 km (1,500 km radius of the transmitting station). There are four time zones within the reception range.

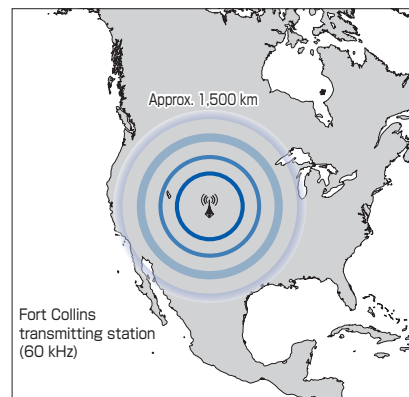

WWVB is operated by NIST.  
 Fort Collins transmitting station  
 Frequency: 60 kHz

※ NIST: National Institute of Standards and Technology

- ※ The watch may be able to receive radio signals outside a reception range if the receiving conditions are favorable.
- ※ The watch may fail to receive radio signals depending on the reception conditions (weather, geographic locations, radio disturbances such as tall buildings, and orientation of the watch).  
 → Environments in which it is difficult to receive a radio signal P.99

## How to check the reception results

### About reception result display

The second hand indicates the latest radio signal reception results (Yes/No) for five seconds.

4

How to Set the Time (Radio Signal Reception)

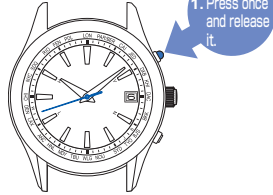

#### 1. Press Button A once and release it.

The second hand indicates the reception results.

#### 2. Check if the reception was successful (within five seconds).

If the reception was **successful: Y**  
(the 10-second position)



If the reception **failed: N**  
(the 20-second position)



※ When 5 seconds have elapsed or if Button A is pressed, the watch returns to the TIME display mode.

96

### To Improve radio signal reception

- Place the watch in a place where it can easily receive a radio signal such as near a window.

The antenna is embedded at the 9 o'clock position of the watch. Turning the antenna toward the outside of a window or the direction facing transmitting stations helps improve radio signal reception.

※ Locations of transmitting stations → Radio Signal Reception Range Indication P.93-95

- Do not move the watch while it is receiving radio signals.

To enhance the reception of radio signals, do not move the watch or do not change the orientation of the watch while it is receiving radio signals.

※ If the button or crown is operated while the watch is receiving a radio signal, the reception will be cancelled.

- The place where the watch is put before going to bed

Place the watch next to a window facing in the direction of a transmitting station before bedtime because automatic reception is performed late at night. Also, please search for a place to easily receive radio signals when attempting manual reception.

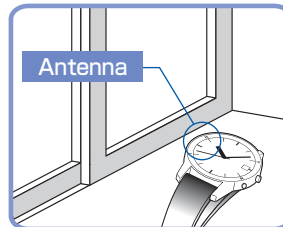

4

How to Set the Time (Radio Signal Reception)

98

### If a reception was successful: The second hand points to Y

- A radio signal has been received successfully. Use the watch without any adjustments.

※ If either the time or date is incorrect, even when successfully receiving a radio signal  
→ "Misalignment of the time and hand positions" on P.132 and "Misalignment of the date" on P.133 in Troubleshooting

### If reception has failed: The second hand points to N.

- Place the watch in a place where it can easily receive a radio signal, or change its direction.

Even within the radio signal reception range, this watch may fail to receive a radio signal depending on the condition (due to the influence of weather, geographical features, buildings, or direction).

→ In this case, refer to Environments in which it is difficult to receive a radio signal on P.99.

This watch is unable to receive radio signals outside a reception range

→ About reception conditions on P.93

- Make sure that the time zone is correctly selected before attempting radio signal reception.

If the time zone is set to a region other than Japan, China, or the U.S.A, the signal reception function will not work. Check the time zone setting → How to select the time zone on P.86

- Attempt to receive a radio signal in a different time period (In the case of manual reception).

Receiving environments differ according to time periods even at the same place.

Due to radio signal characteristics, the watch is able to easily receive radio signals during nighttime hours.

- If you use the watch in a place or region outside the radio signal reception range or when the watch cannot successfully receive radio signals, manually set the time and date.

→ How to manually set the time P.122

→ How to manually set the date P.124

4

How to Set the Time (Radio Signal Reception)

97

### Environments in which it is difficult to receive a radio signal

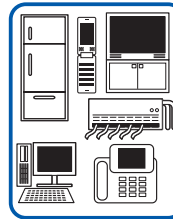

Close to home electrical appliances such as TV's, refrigerators or air conditioners

Close to OA devices such as mobile phones, personal computers or fax machines

Close to steel desks or other furniture made of metal

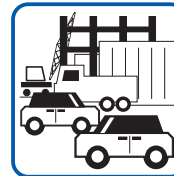

In places generating radio interference, such as construction sites or places with heavy traffic.

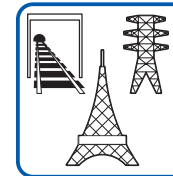

Close to overhead power lines, TV stations, train cables.

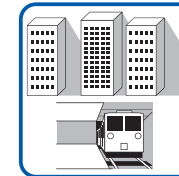

Inside a building, between tall buildings, underground.



Inside a vehicle, train, or airplane

Avoid putting the watch in such places when it receives radio signals.

4

How to Set the Time (Radio Signal Reception)

99

### ⚠ CAUTIONS

- The watch may display the wrong time if it fails to receive radio signals properly because of interference. The watch may also fail to receive radio signals properly depending on the location or radio wave receiving conditions. In this case, move the watch to another place where it can receive radio signals.
- When the watch is out of reception range, its accurate quartz movement (loss / gain:  $\pm 15$  seconds per month on average) will continue to keep the time.
- The time signal transmission may be stopped during maintenance of the facilities of each transmitting station or because of a lightning strike. In such a case, see each station's website for further information or contact SEIKO CUSTOMER SERVICE CENTER.

#### • Websites of transmitting stations (as of December 2017)

Japan: NICT (Japan Standard Time Group) <http://www.jjy.nict.go.jp/>

China: NTSC <http://www.ntsc.ac.cn>

The U.S.A:

NIST <https://www.nist.gov/pml/time-and-frequency-division/radio-stations/wwwb>

## About charging

### ■ How to charge the watch

Expose the dial to light to charge the watch.



To ensure optimal performance of the watch, make sure that the watch is kept sufficiently charged at all time.

※ When charging the watch, make sure that the watch is not heated to a high temperature. (The operational temperature range is between  $-10^{\circ}\text{C}$  and  $+60^{\circ}\text{C}$ .)

※ When first using the watch or starting to use the watch after it has stopped because of the energy depletion, sufficiently charge the watch referring to the table on the page at the right.

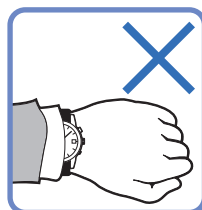

Under the following situations, the energy of the watch is likely to be depleted, resulting in stoppage of the watch.

- The watch is concealed under a sleeve.
- The watch is used or stored under conditions where it cannot be exposed to light for a long time.

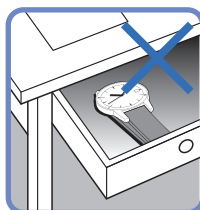

### ■ Standard charging time

For an approximate time required to charge the watch, refer to the table below.

Illumination lx (LUX)	Light source	Condition (Example)	Time required for fully charging the watch	Time required for charging the watch to start moving at one-second intervals	Time required for charging the watch to run for one day
500	Incandescent light	60W 60cm	—	—	5 hours
700	Fluorescent light	General offices	—	—	3 hours
1,000	Fluorescent light	30W 70cm	—	120 hours	2 hours
3,000	Fluorescent light	30W 20cm	90 hours	30 hours	30 minutes
5,000	Fluorescent light	30W 12cm	70 hours	24 hours	24 minutes
10,000	Fluorescent light	30W 5cm	25 hours	8 hours	9 minutes
10,000	Sunlight	Cloudy day	25 hours	8 hours	9 minutes
100,000	Sunlight	Sunny day (Under the direct sunlight on a summer day)	8 hours	2 hours	3 minutes

The figures of "Time required for charging the watch to start moving at one-second intervals" are estimations of time required to charge the stopped watch by exposing it to light until it moves at steady one-second intervals. Even if the watch is partially charged for a shorter period, the watch will resume one-second-interval movement. However, it may shortly return to two-second-interval movement. Use the charging time in this column as a rough guide for sufficient charging time.

※ The second hand movement indicates the remaining amount of energy. \*1. Checking the charging status\* P.82

※ The required charging time slightly varies depending on the model of the watch.

## About energy

### Energy depletion forewarning function

The energy depletion forewarning function is activated when the energy stored in the watch runs low. In such a case, the second hand moves at two-second intervals. If the watch continues to be in the state of two-second interval movement, the watch switches to five-second interval movement, followed by a completely stopped state. If the energy depletion forewarning function is activated, charge the watch sufficiently.

How to charge the watch ..... P.102  
Standard charging time ..... P.103

- ※ Neither the buttons nor the crown can be operated while the second hand moves at two-second or five-second intervals (this is not a malfunction).
- ※ While the second hand moves at five-second intervals, the hour and minute hands, as well as the date, stop operating.
- ※ While the second hand moves at five-second intervals, the watch is unable to receive radio signals automatically. After the watch is charged sufficiently and the second hand returns to normal one-second interval movement, conduct the manual reception of radio signals to set the watch to the correct time. (Refer to Automatic reception and manual reception on P.92.)

### Power save function

This watch is equipped with a power save function which can suppress energy consumption when it is left without receiving an adequate light source for a certain length of time.  
※ There are two types of power save mode.

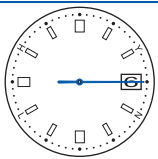
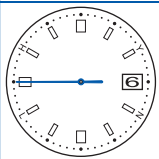
	Power Save 1	Power Save 2
Condition	When the watch is exposed to a state without receiving an adequate light source for 72 hours or longer.	When the watch is in an insufficient charging state for a long time.
Situation	 <p>The second hand stops pointing at the 15-second position, and the hour and minute hands, as well as the date, also stop.</p> <p>The watch conducts automatic radio signal receiving.</p>	 <p>The second hand stops pointing at the 45-second position, and the hour and minute hands, as well as the date, also stop.</p> <p>The watch does not conduct automatic radio signal receiving.</p>
How to handle the situation	When the watch is exposed to a light source for over five seconds, or when a button is pressed, it displays the current time again after the second hand is rapidly advanced.	After sufficiently charging the battery, set the watch for the current time if necessary.

#### Power Save 2

- ※ While the watch is being charged, the second hand moves at "Five-second Intervals."
- During the "Five-second Interval Movement," neither the buttons nor the crown can be operated.
- ※ If the "Power Save 2" mode is prolonged, the stored power amount drops and the internal current time information stored will be lost. When the watch returns to its normal movement of one-second interval after sufficiently charging the battery, set the current time by receiving a radio signal. (Refer to Automatic reception and manual reception → P.92)

## Daily care

### The watch requires good daily care

- Do not wash the watch when its crown is at the extended position.
- Wipe away moisture, sweat or dirt with a soft cloth
- After soaking the watch in seawater, be sure to wash the watch in clean pure water and wipe it dry carefully.
- ※ If your watch is rated as "non-water resistant" or "water resistant for daily use," do not wash the watch.  
→ Performance and type P.106.  
Water resistance P.107.

### Turn the crown from time to time

- In order to prevent corrosion of the crown, turn the crown from time to time.
- The same practice should be applied to a crown. (No need to pull out the screw lock type crown.) → Crown P.81

## Performance and type

The case back shows the caliber and performance of your watch.

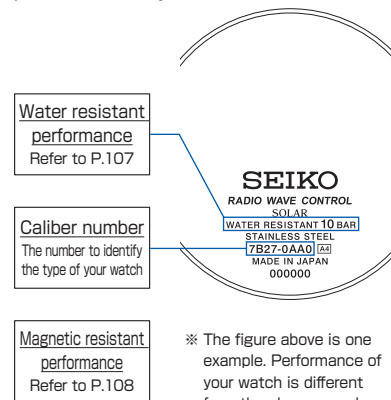

## Water resistance



Refer the table below for the description of each degree of water resistant performance of your watch before using.  
(Refer to "P.106")

Indication on the case back	Water resistant performance	Condition of use
No indication	Non-water resistance	Avoid drops of water or sweat
WATER RESISTANT	Water resistance for everyday life	The watch withstands accidental contact with water in everyday life. <b>WARNING</b> Not suitable for swimming
WATER RESISTANT 5 BAR	Water resistance for everyday life at 5 barometric pressures	The watch is suitable for sports such as swimming.
WATER RESISTANT 10 (20) BAR	Water resistance for everyday life at 10(20) barometric pressures.	The watch is suitable for diving not using an air cylinder.

## Magnetic resistance

Affected by nearby magnetism, a watch may temporarily gain or lose time or stop operating.

※ When the hand positions deviate to display incorrect time as a result of influence of magnetism, this watch automatically corrects the hand alignment itself. (Refer to P.126)

Indication on the case back	Condition of use
No indication	Keep the watch more than 10 cm away from magnetic products.
	Keep the watch more than 5 cm away from magnetic products. (JIS level-1 standard)
	Keep the watch more than 1 cm away from magnetic products. (JIS level-2 standard)

If the watch becomes magnetized and its accuracy deteriorates to an extent exceeding the specified rate under normal use, the watch needs to be demagnetized. In this case, you will be charged for demagnetization and accuracy readjustment even if it happens within the guarantee period.

The reason why watch is affected by magnetism

The built-in motor is provided with a magnet, which may be influenced by a strong external magnetic field.

## Examples of common magnetic products that may affect watches

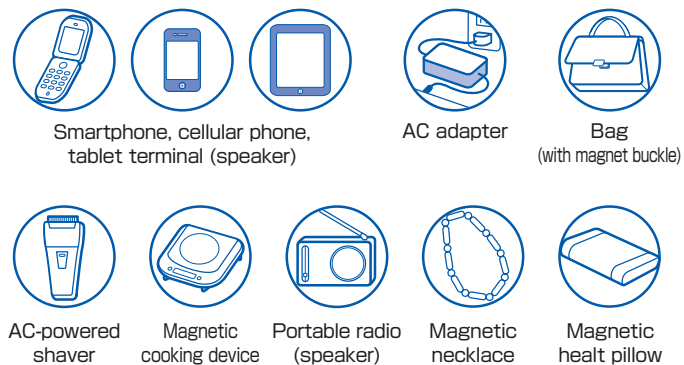

## Band

The band touches the skin directly and becomes dirty with sweat or dust. Therefore, lack of care may accelerate deterioration of the band or cause skin irritation or stain on the sleeve edge. The watch requires a lot of attention for long usage.

### ●Metallic band

- Moisture, sweat or soil will cause rust even on a stainless steel band if they are left for a long time.
- Lack of care may cause a yellowish or gold stain on the lower sleeve edge of shirts.
- Wipe off moisture, sweat or soil with a soft cloth as soon as possible
- To clean the soil around the joint gaps of the band, wipe it out in water and then brush it off with a soft toothbrush.  
(Protect the watch body from water splashes by wrapping it up in plastic wrap etc.)
- Because some titan bracelets use pins made of stainless steel, which has outstanding strength, rust may form in the stainless steel parts.
- If rust advances, pins may poke out or drop out, and the watch case may fall off the bracelet, or the clasp may not open.
- If a pin is poking out, personal injury may result. In such a case, refrain from using the watch and request repair.

### ●Leather band

- A leather band is susceptible to discoloration and deterioration from moisture, sweat and direct sunlight.
- Wipe off moisture and sweat as soon as possible by gently blotting them up with a dry cloth.
- Do not expose the watch to direct sunlight for a long time.
- Please take care when wearing a watch with light-colored band, as dirt is likely to show up.
- Refrain from wearing a leather band watch other than Aqua Free bands while bathing, swimming, and when working with water even if the watch itself is water-resistant enforced for daily use (10-BAR water resistant).

### ●Polyurethane band

- A polyurethane band is susceptible to discoloration from light, and may be deteriorated by solvent or atmospheric humidity.
- Especially a translucent, white, or pale colored band easily adsorbs other colors, resulting in color smears or discoloration.
- Wash out dirt in water and clean it off with a dry cloth.  
(Protect the watch body from water splashes by wrapping it up in plastic wrap etc.)
- When the band becomes less flexible, have the band replaced with a new one. If you continue to use the band as it is, the band may develop cracks or become brittle over time.

Notes on skin irritation and allergy	Skin irritation caused by a band has various reasons such as allergy to metals or leathers, or skin reactions against friction on dust or the band itself.
Notes on the length of the band	Adjust the band to allow a little clearance with your wrist to ensure proper airflow. When wearing the watch, leave enough room to insert a finger between the band and your wrist. 

## Special clasps

There are 3 type of special clasps as described below; If the clasp of the watch you purchased is one of them, please refer to the indications.

### A A Type → P.113

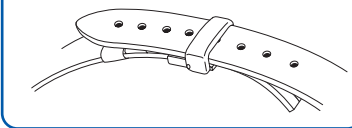

### B B Type → P.114

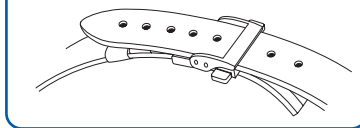

### C C Type → P.115

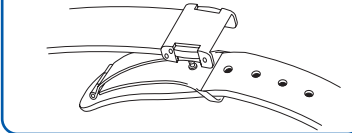

### A A Type

1. Lift up the clasp to release the buckle.

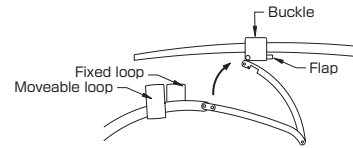

2. Open the flap.

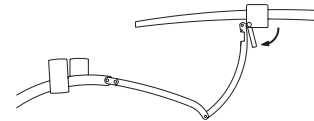

3. Take the pin out of the adjustment hole, adjust the size of the strap by sliding it back and forth, and then put the pin back into the appropriate adjustment hole.

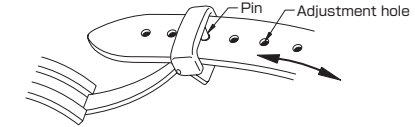

4. Close the flap.

※ Do not push the flap in too hard.

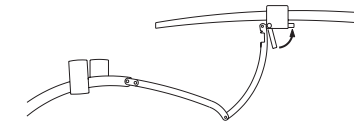

※ When fastening the clasp, insert the tip of the band into the movable loop and fixed loop, and then, securely tighten the clasp.

### B B Type

#### ●How to wear or take off the watch

1. Press the button on both sides of the flap; pull the buckle up. The band will automatically come out of the loop.

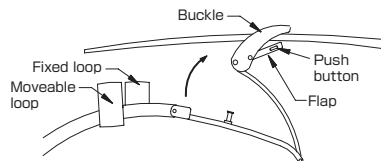

2. Place the tip of the band into the moveable loop and fixed loop, and fasten the clasp by pressing the frame of the buckle.

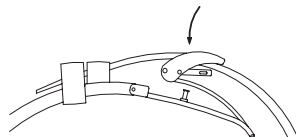

#### ●How to adjust the length of the leather band

1. With pressing buttons on both sides of the flap, pull the leather band out of the moveable loop and fixed loop. Then open the clasp.

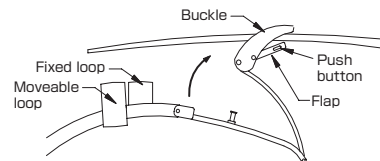

2. Press the push buttons again to unfasten the flap.

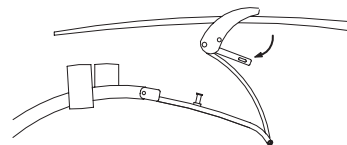

3. Pull the pin out of a adjustment hole of the band. Slide the band to adjust its length and find an appropriate hole. Place the pin into the hole.

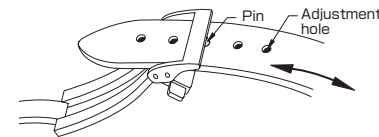

4. Fasten the flap.

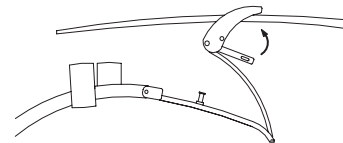

### C C Type

1. Press the button on the buckle, and lift to open the clasp.

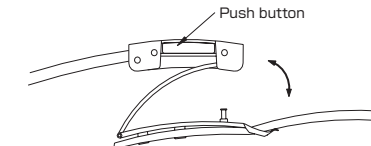

2. Pull the pins out of the adjustment holes on the band. Slide the band to the appropriate length. Push the pins into the new holes on the band. Fasten the buckle.

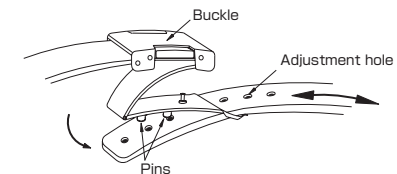

## Power source

The battery used in this watch is a special secondary battery, which is totally different from ordinary silver oxide batteries.

Unlike other disposable batteries such as dry-cell batteries or button cells, this secondary battery can be used over and over again by repeating the cycles of discharging and recharging. However, for various reasons such as long-term use or usage conditions, the capacity or recharging efficiency of the secondary battery may gradually deteriorate. Worn or contaminated mechanical parts or degraded oils may also shorten recharging cycles. If the efficiency of the secondary battery decreases, have the watch repaired.

### NOTICE

#### Remarks on replacing the secondary battery

- Do not remove the secondary battery yourself.
- Replacement of the secondary battery requires professional knowledge and skill. Please ask a watch retailer for repair.
- When replacing the secondary battery, make sure that the exclusive secondary battery for this watch is used. Installation of an ordinary silver oxide battery can generate heat that can cause bursting or ignition.

#### ※ Overcharge prevention function

When the secondary battery is fully charged, the overcharge prevention function is automatically activated to avoid further charging. There is no need to worry about damage caused by overcharging no matter how much the secondary battery is charged in excess of the "time required for fully charging the watch".

※ Refer to "Standard charging time" on P.103 to check the time required for fully charging the watch.

## After-sale service

### ● Notes on guarantee and repair

- Contact the retailer the watch was purchased from or SEIKO CUSTOMER SERVICE CENTER for repair or overhaul.
- Within the guarantee period, present the certificate of guarantee to receive repair services.
- Guarantee coverage is provided in the certificate of guarantee. Read carefully and retain it.
- For repair services after the guarantee period has expired, if the functions of the watch can be restored by repair work, we will undertake repair services upon request and payment.

### ● Replacement parts

- SEIKO makes it a policy to typically keep a stock of replacement parts for this watch for 7 years. Replacement parts are those which are essential to maintaining the functional integrity of the watch.
- Please keep in mind that if original parts are not available, they may be replaced with substitutes whose outward appearance may differ from the originals.

### ● Inspection and adjustment by disassembly and cleaning (overhaul)

- Periodic inspection and adjustment by disassembly and cleaning (overhaul) is recommended approximately once every 3 to 4 years in order to maintain optimal performance of the watch for a long time. According to use conditions, the oil retaining condition of your watch mechanical parts may deteriorate, abrasion of the parts due to contamination of oil may advance or delay the time significantly, or the watch itself may stop. As the parts such as gasket may deteriorate, water-resistant performance may be impaired due to intrusion of perspiration and moisture. Please contact the retailer from whom the watch was purchased for inspection and adjustment by disassembly and cleaning (overhaul). For replacement of parts, please specify "SEIKO GENUINE PARTS." When asking for inspection and adjustment by disassembly and cleaning (overhaul), make sure that the gasket and push pin are also replaced with new ones.
- When your watch is inspected and adjusted by disassembly and cleaning (overhauled), the movement of your watch may be replaced.

### NOTICE

#### Notes on charging the watch

- When charging the watch, do not place the watch in close proximity to an intense light source such as lighting equipment for photography, spotlights or incandescent lights, as the watch may be excessively heated resulting in damage to its internal parts.
- When charging the watch by exposure to direct sunlight, avoid places that easily reach high temperatures, such as a car dashboard.
- Always keep the watch temperature under 60°C.

## Lumibrite

Lumibrite is a luminous paint that is completely harmless to human beings and natural environment, containing no noxious materials such as radioactive substance.

Lumibrite is a newly-developed luminous paint that absorbs the light energy of the sunlight and lighting apparatus in a short time and stores it to emit light in the dark. For example, if exposed to a light of more than 500 lux for approximately 10 minutes, Lumibrite can emit light for 3 to 5 hours.

Please note, however, that, as Lumibrite emits the light it stores, the luminance level of the light decreases gradually over time. The duration of the emitted light may also differ slightly depending on such factors as the brightness of the place where the watch is exposed to light and the distance from the light source to the watch.

※ The above comments are applied to the watch with Lumibrite.

※ In general, when coming from a place that is bright to a place that is dark, it takes human eyes some time to adapt to the darkness making it difficult to see objects initially. (Dark adaptation)

※ LumiBrite is luminous paint that stores and emits light, which is harmless to human beings and the environment, containing no toxic materials such as radioactive substances.

## How to conduct manual reception (Receiving a radio signal manually)

### 1. Put the watch down.

Place the watch where it can easily receive radio signals.

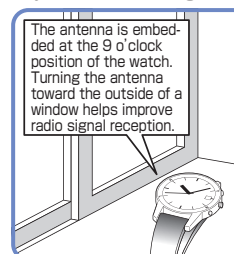

- To improve radio signal reception P.98
- Environments in which it is difficult to receive a radio signal P.99
- ※ This watch is unable to receive radio signals outside a reception range.
- About reception conditions P.93

### 2. Press and hold Button A until the second hand moves to the 0-second position (for three seconds).

▶ After the second hand moves to the 0-second position and stops, the watch will start to receive radio signals.

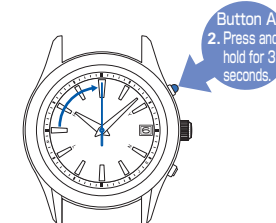

- ※ If the time zone is set to a region other than Japan, China, and the U.S.A, the second hand will not move to the 0-second position. (The manual reception function will not work.) Check if the time zone is correctly set.
- Check the time zone setting.
- How to select the time zone P.86



Continued on the next page.

3. Leave the watch untouched for several minutes. (For twelve minutes at the longest)

▶ When the second hand starts moving in one-second intervals, the reception is completed.

**Reception takes some time.**  
(12 minutes at the longest)  
※ It depends on the radio signal conditions.

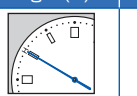
<Display before completing the reception>  
The second hand indicates the reception level. (Updated every minute)

Receiving Level	High: (H)	Low: (L)
Display		
Radio signal condition	Easy to receive	Hard to receive

※ In conjunction with the second hand movement, the minute hand advances by one minute.

4. When the second hand starts moving in one-second intervals, check if the signal reception was successfully conducted.

Upon completion of the signal reception, check if the reception was successful.  
→ About reception result display P.96  
※ During movement of the date, neither the buttons nor the crown can be operated.

<If the reception has failed>  
The second hand indicates the reception result by pointing to N.

Reception result: N



After five seconds, the watch returns to the TIME display mode.

→ If reception has failed: The second hand points to N. P.97

### ■ How to manually set the time

When the watch is used continuously in conditions in which the watch may be unable to receive a radio signal, it can be manually adjusted.

→ About reception conditions P.93

- When using the watch again in regions in which the watch is able to receive a radio signal, it is recommended to perform "Manual reception."  
→ Automatic reception and manual reception P.92
- When adjusting the time, the date will be accordingly adjusted.

※ When the watch is unable to receive a radio signal, it can move depending on normal quartz movement (accuracy of loss / gain: ± 15 seconds per month).  
※ When the watch receives a radio signal after manual adjustment of the time, it displays the received time.

## When the watch is unable to receive radio signals

When the watch is unable to receive radio signals, refer to the following pages for remedies.

- **When the watch cannot receive radio signals within the signal reception range.**  
→ **At trouble Reception of a radio signal** P.131  
If the above remedies do not solve the problem, set the time and date referring to the "How to manually set the time or date" section below.  
→ How to manually set the time P.122  
→ How to manually set the date P.124  
※ For the signal reception range, refer to Radio About reception conditions P.93.
- **To use the watch outside the reception range**  
Set the watch to the time zone of the place where you use the watch.  
→ How to select the time zone P.86  
When the watch is unable to display the correct time and date, even if the time zone is selected, manually set the time and date.



- ※ Unlock the crown before operating it and then, relock it after completing the operation. → P.81
- ※ When the watch enters the manual time setting mode, the reception results will be indicated as "N," since the reception results data will be lost.
- ※ The point in which the date changes at 0:00 AM (12:00 PM). Adjust the time taking into consideration that it is set during the AM and PM.

1. Pull out the crown to the second click.

▶ The second hand moves to point to the 0-second position and the watch enters the manual time setting mode.

2. Press Button A to set the time.

One minute Advance	Press the button once and then release it.
Continuous Advance	When the button is kept pressed for two seconds or longer, the hand will start to move. Press the button again to stop.

※ Turning the crown will not move the hand.

3. Push the crown back in simultaneously with a time signal.

▶ Operation has been completed.  
The watch resumes its normal movement.

### How to manually set the date

If you use the watch outside the radio signal reception range or in conditions where the watch cannot receive radio signals, the date will not be automatically adjusted. In such a case, especially on the first day after a month that has less than 31 days, the watch requires manual date setting.

- The date can be adjusted independently of the time.
- To use the watch in a radio signal receivable condition again, conduct automatic signal reception to set the time. → Automatic reception and manual reception P.92
- ※ When the watch receives radio signals after the date is manually adjusted, it displays the date received from radio signals.
- ※ If the date remains incorrect even after a successful radio signal reception, the preliminary position of the date may be misaligned. → How to correct the preliminary positions P.127

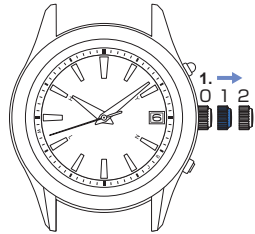

※ Unlock the crown before operating it and then, relock it after completing the operation. → P.81

#### 1. Pull out the crown to the first click.

▶ This initiates the mode for manually adjusting the date.

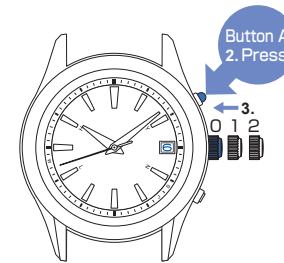

#### 2. Press Button A to set the date.

To advance one day	Press the button once and release.
To advance rapidly	Keep pressing down the button for longer than 2 seconds. Press the button once again to stop.

- ※ Turning the crown will not move the hand.
- ※ While the date is moving, the button cannot be operated.
- ※ The date can only move forward. It cannot move backward.

#### 3. Push the crown back.

▶ The operation is now completed.

## Preliminary position

When the watch is unable to display the precise time or date, even if it successfully receives a radio signal with the correct time zone setting, the preliminary position may be misaligned. The preliminary position may be misaligned due to the following reasons.

- In the case of having a strong impact: misalignment of the time and date may occur when dropping or hitting the watch.
  - In the case of a magnetic influence: misalignment of the time and date may occur when bringing the watch close to an object which generates magnetism.
- Examples of common magnetic products that may affect watches P.109

When comparing the state of "Misaligned Preliminary Hand Position" to that of a weight scale, it is like "a scale which is unable to display the correct weight because its needle is not set to the zero position before weighing."

### Automatic Hand Position Adjustment Function (Function to automatically adjust the preliminary position of the hour and minute hands)

The hour, minute, and second hands have an "Automatic Hand Position Adjustment Function," which automatically corrects an incorrect preliminary position. Automatic Hand Position Adjustment Function activates once a minute for the second hand and at 12:00 both for the AM and PM for the hour and minute hands.

- ※ This function works when the preliminary hand position is misaligned due to external factors such as a strong impact or magnetic influence. It does not work to adjust accuracy of the watch or slight deviations which may occur during the manufacturing process.
- ※ The preliminary position of the hour and minute hands can also be manually adjusted. → Setting the preliminary position of the date P.127

### Setting the preliminary position of the date

Since the preliminary position of the date is not automatically adjusted, it must be adjusted manually. → Setting the preliminary position of the date P.127

## How to correct the preliminary positions

### Setting the preliminary position of the date, hour and minute hands

The preliminary position of the date is the "1st."  
The preliminary positions of the hour and minute hands are "0:00 AM."

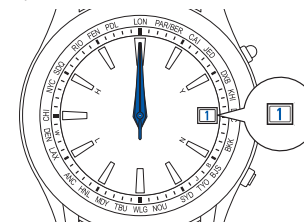

When the preliminary positions are incorrect, the correct time and date cannot be displayed even if the watch receives radio signals.

In such a case, by correcting the preliminary positions, the loss or gain of the time or date can be corrected.

When the numerical number of the date is not located at the center of the window, it can be corrected by the same procedures as mentioned above.

To correct the preliminary positions, perform the operation on the next page.

■ Setting the preliminary position of the date, hour and minute hands (continued)  
 Within 10 seconds after procedure 1. is completed and the date stops, start the operation of procedure 2.

※ If the watch is left untouched for 10 seconds after the date stops, the watch automatically returns to the TIME display mode. If this happens, restart the operation from procedure 1.

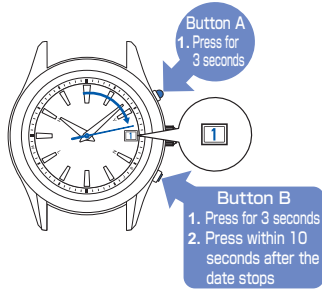

- ※ Do not pull the crown out.
- ※ Press Button B with your finger or with an object with a long tapered tip. → P.80

1. Keep pressing down Button A and B (for 3 seconds) at the same time until the second hand stops pointing to the 13-second position.

▶ The watch enters the preliminary position setting mode for date. The date will start to move and stop at the preliminary position.  
 ※ First, press Button B, and subsequently press Button A while holding down Button B so as to press both of them successfully.  
 ※ While the date is moving, the button cannot be operated.

2. Within 10 seconds after the date stops, press Button B to set the date to "1."

▶ Make sure that the numerical number "1" is located at the center of the date window.  
 ※ If "1" is already displayed in the date window, move on to procedure 3.

To advance rapidly	Keep pressing down the button for longer than 2 seconds. Press the button once again to stop.
To fine-tune	When the button is pressed intermittently, the hand will slightly advance.

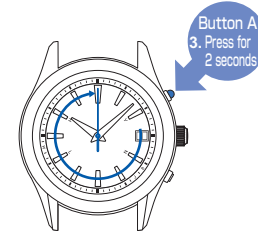

3. Keep pressing down Button A (for 2 seconds) until the second hand stops pointing to the 0-second position.

▶ The watch enters the preliminary position setting mode for hour and minute hands.  
 ※ If the hour and minute hands are already indicating the correct time, move on to procedure 5.

4. Press Button B once and release it.

▶ The hour and minute hands start to move and stop pointing at "0:00 am."

5. After completing the operation, leave the watch untouched for 10 seconds.

▶ The watch automatically exits the preliminary position setting mode, and the second, hour and minute hands start moving.

When the watch returns to the TIME display mode, check if the time and date are correct. If the time and date are not correct, manually set them.

Adjusting the time and date by receiving a radio signal  
 How to conduct manual reception → P.119

When the watch is unable to receive a radio signal  
 How to manually set the time → P.122

How to manually set the date → P.124

At trouble			
	Condition	Solutions	Reference pages
Hand Movement	The second hand moves at two-second intervals.	The energy depletion forewarning function is activated. (P.104) Fully charge the watch so that the second hand may move at one-second intervals.	P.104
	The second hand moves at five-second intervals.	Be careful not to conceal the watch under a sleeve, etc., while wearing it. When taking off the watch, place it in as bright a location as possible.	
	The stopped second hand pointing to the 15-second position started operating.	The power save function has been activated. (P.105) Wait until the current time is displayed. No operation is needed (this is not a malfunction.)	—
	The stopped second hand pointing to the 45-second position started operating.	The power save function has been activated. (P.105) 1. Fully charge the watch so that the second hand may move at one-second intervals. 2. After that, if the watch displays the incorrect time, receive a radio wave as needed.	P.102 P.91
	The watch hands advance rapidly unless a button is pressed. After the rapid advancement is completed, the watch resumes its normal movement.	The power save function has been activated. (P.105) The automatic hand position adjustment function is activated. (P.126) No operation is needed (this is not a malfunction).	—

	Condition	Solutions	Reference pages
Reception of a radio signal	When the watch is unable to receive a radio signal	Do not move the watch while it is receiving a radio signal. Because it takes time to receive a radio signal successfully, leave the watch untouched for 12 minutes at the longest. Place the watch where it is able to easily receive a radio signal.	P.98 P.119 P.98
	The reception results have failed and the second hand points to N (the watch does not receive a radio signal).	Transmitting stations may have stopped transmitting radio signals for some reason (Transmission stop). Check the website of each transmitting station for further information concerning a transmission stop. Attempt to receive a radio signal again after a while. Reselect the time zone able to receive the radio signal.	P.100 P.86 P.93
Charging the solar battery	The stopped watch was exposed to an adequate light for longer than "the time required to fully charge the watch," however, it does not resume its normal one-second interval movements.	The time required for charging the watch depends entirely on the amount of exposed light the watch receives. Refer to "Standard charging time" to charge the watch.	P.103
		The built-in IC of the watch has fallen into an unstable condition. Refer to "In case of an abnormal movement" to reset the built-in IC.	P.134

Condition		Solutions	Reference pages
Misalignment of the time and hand positions	The watch temporarily gains or loses time.	1. Place the watch where it is able to receive a radio signal more easily. 2. Conduct manual reception if necessary.	P.98 P.119
		1. In case the watch has been left in a place with an extremely high or low temperature for a long time. When the watch returns to a normal temperature, it will display the precise time as before. 2. If the watch still gains or loses the time, conduct manual reception if necessary. 3. If the watch cannot resume normal movement even after conducting the above mentioned procedures, consult the retailer from whom the watch was purchased.	P.119 —
	The watch displays an incorrect time hour unit, even though it displays the precise time of minutes and seconds	Make sure that the watch is set to the time zone that covers the place where you use the watch.	P.86
	The reception results are successful, but the precise time is not displayed.	1. No crown or button operation is needed, since the automatic hand position adjustment function will be activated to align the hand positions. Automatic Hand Position Alignment Function activates once a minute for the second hand and at 12:00 both for the AM and PM for the minute and hour hands. It can be manually adjusted, when you hurry up. 2. If the watch still gains or loses time, refer to "In case of an abnormal movement" to perform procedures.	P.126 P.122
	The second hand position is not correctly aligned in "the reception results display" or "the reception level display."	3. If the watch cannot resume normal movement even after conducting the above mentioned procedures, consult the retailer from whom the watch was purchased.	P.134 —

Condition		Solutions	Reference pages
Misalignment of the date	The reception results are successful and the precise time is displayed, but the date is not correctly displayed.	Set the date to the preliminary position "1" (the 1st).	P.127
Operation	The crown or buttons cannot be operated.	Sufficiently charge the watch until it starts moving at one-second intervals. When the date hand is moving right after a setting is carried out by a crown or button operation, after the date stops, the crown and buttons can be operated.	P.102
	You get lost in the middle of the operation.	1. If the crown is pulled out, push it back in. 2. The watch will resume its normal one-second interval movements within 9 minutes. 3. Start the setting procedure from the beginning.	—
Others	Blur on the dial glass persists.	Contact the retailer from whom the watch was purchased.	—

※ For the solution of troubles other than the above, consult the retailer from whom the watch was purchased.

### In case of an abnormal movement

In the case that the watch moves abnormally or that the watch does not move at one-second intervals even after fully charging the battery, perform the procedures from 1. to 3. and then set the preliminary positions and select the time zone.

#### ■ How to reset the built-in IC

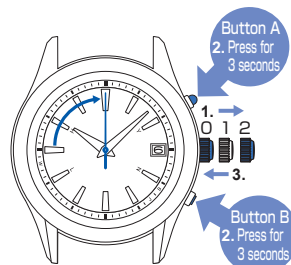

※ Unlock the crown before operating it and then, relock it after completing the operation. → P.81  
(NOTE) First, press Button B, and subsequently press Button A while holding down Button B so as to press both of them successfully.

- 1. Pull out the crown to the second click.**
  - ▶ The second hand stops at the 0-second position.
- 2. Keep pressing down Button A and B at the same time for 3 seconds, and then release them.**
  - ▶ Within 5 seconds after releasing the buttons, the second hand makes a full rotation and stops pointing to the 0-second position. Then the hour and minute hands will start to move and stop pointing to 12 o'clock 0 minutes.<sup>(NOTE)</sup>
- 3. When all the hands stop pointing to 12 o'clock 0 minutes and 0 seconds, push the crown back.**
  - ▶ The second hand starts moving from 12 o'clock 0 minutes and 0 seconds.
  - ※ After the built-in IC is reset, the watch is set to the time zone LON. After completion of a system reset, perform the following operations.
    - How to correct the preliminary positions → P.128 1.2.
    - How to select the time zone → P.86 - 87
    - How to adjust the time (forced reception method) → P.119 - 120

### Specifications

- Basic feature ..... Basic watch with three hands (hour, minute and second hands), date display
- Frequency of crystal oscillator ..... 32,768 Hz (Hz = Hertz ... Cycles per second)
- Loss/gain (monthly rate) ..... Loss / gain ±15 seconds on a monthly rate (Except the case when the watch is used without an automatic time setting by receiving a radio signal and when it is worn on the wrist within a normal temperature range between 5°C and 35°C).
- Operational temperature range ..... Between -10°C and +60°C
- Driving systems ..... Step motor (Hour and minute hands, second hand, and the date)
- Power source ..... Secondary battery, 1 piece
- Duration of operation ..... Approximately six months (Fully charged, and the Power Save is not activated).  
  - ※ If Power Save is activated after it is fully charged, the watch continues to run for approximately one and a half years at maximum.
- Time setting by receiving the JJY-LF radio signal ..... Automatic reception (before 2:00 AM, 3:00 AM and 4:00 AM)  
  - ※ Reception attempts depend on the radio signal receiving conditions.
  - ※ After having received a radio signal, the watch will start to move depending on the quartz movement until the next reception.
  - ※ Manual reception is also available.
- IC (Integrated Circuit) ..... Oscillator, frequency divider and driving circuit C-MOS-IC, 3 pieces  
  - ※ The specifications are subject to change without prior notice for product improvement.