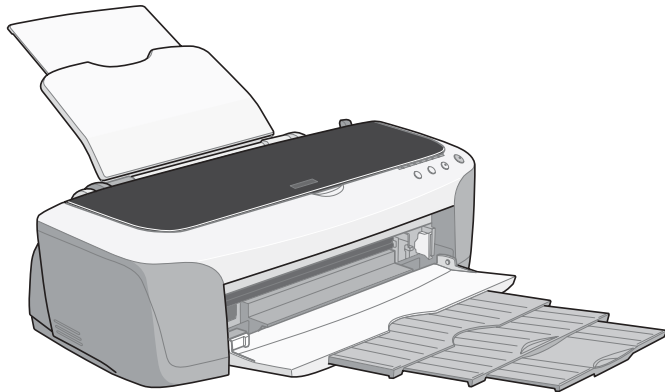


SERVICE MANUAL



Color Inkjet Printer

EPSON Stylus PHOTO 2100/2200



EPSON®

Notice

- ❑ All rights reserved. No part of this manual may be reproduced, stored in a retrieval system, or transmitted in any form or by any means electronic, mechanical, photocopying, or otherwise, without the prior written permission of SEIKO EPSON CORPORATION.
- ❑ All effort have been made to ensure the accuracy of the contents of this manual. However, should any errors be detected, SEIKO EPSON would greatly appreciate being informed of them.
- ❑ The contents of this manual are subject to change without notice.
- ❑ All effort have been made to ensure the accuracy of the contents of this manual. However, should any errors be detected, SEIKO EPSON would greatly appreciate being informed of them.
- ❑ The above notwithstanding SEIKO EPSON CORPORATION can assume no responsibility for any errors in this manual or the consequences thereof.

EPSON is a registered trademark of SEIKO EPSON CORPORATION.

*General Notice: Other product names used herein are for identification purpose only and may be trademarks or registered trademarks of their respective owners.
EPSON disclaims any and all rights in those marks.*

Copyright © 2002 **SEIKO EPSON CORPORATION.**
Imaging & Information Product Division
TPCS Quality Assurance Center
TPCS Department

PRECAUTIONS

Precautionary notations throughout the text are categorized relative to 1) Personal injury and 2) damage to equipment.

DANGER Signals a precaution which, if ignored, could result in serious or fatal personal injury. Great caution should be exercised in performing procedures preceded by DANGER Headings.

WARNING Signals a precaution which, if ignored, could result in damage to equipment.

The precautionary measures itemized below should always be observed when performing repair/maintenance procedures.

DANGER

1. ALWAYS DISCONNECT THE PRODUCT FROM THE POWER SOURCE AND PERIPHERAL DEVICES PERFORMING ANY MAINTENANCE OR REPAIR PROCEDURES.
2. NO WORK SHOULD BE PERFORMED ON THE UNIT BY PERSONS UNFAMILIAR WITH BASIC SAFETY MEASURES AS DICTATED FOR ALL ELECTRONICS TECHNICIANS IN THEIR LINE OF WORK.
3. WHEN PERFORMING TESTING AS DICTATED WITHIN THIS MANUAL, DO NOT CONNECT THE UNIT TO A POWER SOURCE UNTIL INSTRUCTED TO DO SO. WHEN THE POWER SUPPLY CABLE MUST BE CONNECTED, USE EXTREME CAUTION IN WORKING ON POWER SUPPLY AND OTHER ELECTRONIC COMPONENTS.
4. WHEN DISASSEMBLING OR ASSEMBLING A PRODUCT, MAKE SURE TO WEAR GLOVES TO AVOID INJURIES FROM METAL PARTS WITH SHARP EDGES.

WARNING

1. REPAIRS ON EPSON PRODUCT SHOULD BE PERFORMED ONLY BY AN EPSON CERTIFIED REPAIR TECHNICIAN.
2. MAKE CERTAIN THAT THE SOURCE VOLTAGE IS THE SAME AS THE RATED VOLTAGE, LISTED ON THE SERIAL NUMBER/RATING PLATE. IF THE EPSON PRODUCT HAS A PRIMARY AC RATING DIFFERENT FROM AVAILABLE POWER SOURCE, DO NOT CONNECT IT TO THE POWER SOURCE.
3. ALWAYS VERIFY THAT THE EPSON PRODUCT HAS BEEN DISCONNECTED FROM THE POWER SOURCE BEFORE REMOVING OR REPLACING PRINTED CIRCUIT BOARDS AND/OR INDIVIDUAL CHIPS.
4. IN ORDER TO PROTECT SENSITIVE MICROPROCESSORS AND CIRCUITRY, USE STATIC DISCHARGE EQUIPMENT, SUCH AS ANTI-STATIC WRIST STRAPS, WHEN ACCESSING INTERNAL COMPONENTS.
5. DO NOT REPLACE IMPERFECTLY FUNCTIONING COMPONENTS WITH COMPONENTS WHICH ARE NOT MANUFACTURED BY EPSON. IF SECOND SOURCE IC OR OTHER COMPONENTS WHICH HAVE NOT BEEN APPROVED ARE USED, THEY COULD CAUSE DAMAGE TO THE EPSON PRODUCT, OR COULD VOID THE WARRANTY OFFERED BY EPSON.

About This Manual

This manual describes basic functions, theory of electrical and mechanical operations, maintenance and repair procedures of the printer. The instructions and procedures included herein are intended for the experienced repair technicians, and attention should be given to the precautions on the preceding page.

Manual Configuration

This manual consists of six chapters and Appendix.

CHAPTER 1. PRODUCT DESCRIPTIONS

Provides a general overview and specifications of the product.

CHAPTER 2. OPERATING PRINCIPLES

Describes the theory of electrical and mechanical operations of the product.

CHAPTER 3. TROUBLESHOOTING

Describes the step-by-step procedures for the troubleshooting.

CHAPTER 4. DISASSEMBLY / ASSEMBLY

Describes the step-by-step procedures for disassembling and assembling the product.

CHAPTER 5. ADJUSTMENT

Provides Epson-approved methods for adjustment.

CHAPTER 6. MAINTENANCE

Provides preventive maintenance procedures and the lists of Epson-approved lubricants and adhesives required for servicing the product.

APPENDIX Provides the following additional information for reference:

- Connector pin assignments
- Exploded diagram & Parts List
- Electric circuit boards components layout
- Electrical circuit boards schematics

Symbols Used in this Manual

Various symbols are used throughout this manual either to provide additional information on a specific topic or to warn of possible danger present during a procedure or an action. Be aware of all symbols when they are used, and always read NOTE, CAUTION, or WARNING messages.



Indicates an operating or maintenance procedure, practice or condition that is necessary to keep the product's quality.



Indicates an operating or maintenance procedure, practice, or condition that, if not strictly observed, could result in damage to, or destruction of, equipment.



May indicate an operating or maintenance procedure, practice or condition that is necessary to accomplish a task efficiently. It may also provide additional information that is related to a specific subject, or comment on the results achieved through a previous action.



Indicates an operating or maintenance procedure, practice or condition that, if not strictly observed, could result in injury or loss of life.



Indicates that a particular task must be carried out according to a certain standard after disassembly and before re-assembly, otherwise the quality of the components in question may be adversely affected.

Revision Status

Revision	Issued Date	Description
A	May 24, 2002	First Release
B	August 22, 2002	Page 212 Modify the wrong description on the A3+ size Photo Quality Ink Jet Paper Check pattern (first solid pattern) Page 213 The description for A4 size Plain Paper check point was added.

CONTENTS

Chapter 1 PRODUCTION DESCRIPTION

1.1 Overview 9

1.2 Basic Specifications 10

1.2.1 Specification Outline Comparison	10
1.2.2 Paper Specification	15
1.2.3 Printing Area	17
1.2.4 Ink Type-based Medium Compatibility Specifications	23
1.2.5 Release Lever	25

1.3 Functions 26

1.3.1 Control Panel	26
1.3.2 Switches	26
1.3.3 Indicators	26
1.3.4 Switch Functions	26
1.3.5 Default Setting Selection Function	28
1.3.6 Special Setting Mode Function	29
1.3.7 Status Printing	30
1.3.8 Panel Operation for Roll Paper Printing	31
1.3.9 Panel Operation for CD-R Printing	33
1.3.10 Panel Operation for Thick Paper Printing	33
1.3.11 Panel Operation in Roller Cleaning Mode	34
1.3.12 Indicator Display in Normal Mode	35
1.3.13 Error Status	36

1.4 Casing Specifications 37

1.5 Accessories 37

1.6 Environment Specification Items 38

Chapter 2 OPERATING PRINCIPLES

2.1 Overview 40

2.2 Printer Mechanism 40

2.2.1 Carriage Mechanism	41
--------------------------------	----

2.2.2 Print Mode	44
2.2.3 Paper Feeding Mechanism	48
2.2.4 Paper Loading Mechanism	54
2.2.5 Ink System Mechanism	58
2.2.6 Ink Sequence	60
2.2.7 Paper Cutter Mechanism	63
2.2.8 Power-On Sequence	65

2.3 Electrical Circuitry Operating Principles 66

2.3.1 Power Supply Circuit Operating Principle	67
2.3.2 C387MAIN Circuit Operating Principle	68

Chapter 3 TROUBLESHOOTING

3.1 Overview 70

3.2 Error Indications and Fault Occurrence Causes 70

3.3 Troubleshooting 78

3.3.1 Superficial Phenomenon-Based Troubleshooting	104
--	-----

3.4 EEPROM Data Analysis 114

Chapter 4 disassembly and assembly

4.1 Overview 116

4.1.1 Precautions	116
4.1.2 Tools to Be Used	117
4.1.3 Screw List	118
4.1.4 Pre-Shipment Checks	119

4.2 Disassembly 120

4.2.1 Removing the Housings	121
4.2.2 Removing the Board Assembly	127
4.2.3 Removing the Waste Ink Pads	131
4.2.4 Removing the ASF Unit	132
4.2.5 Removing the Paper Eject Unit	140

4.2.6 Removing the Paper Eject Roller B	144
4.2.7 Removing the Printhead	146
4.2.8 Removing the Carriage Guide Shaft B	149
4.2.9 Removing the Carriage Guide Shaft A and Carriage Unit	152
4.2.10 Removing the Ink System Unit	158
4.2.11 Removing the Release Lever Shaft	159
4.2.12 Removing the Sensors	161
4.2.13 Removing the Motors	168
4.2.14 Removing the DE Unit and ASF/Pump Motor	171
4.2.15 Removing the PF Roller	175
4.2.16 Removing the Paper Eject Roller Shaft A	179
4.2.17 Removing the PF Roller Support	181
4.2.18 Disassembling the Cutter Unit	182
4.2.19 Fitting the Protective Materials	186

Chapter 5 Adjustment

5.1 Adjustment Items and Overview 188

5.1.1 Servicing Adjustment Item List	188
5.1.2 Priority of Adjustment Items	193
5.1.3 Replacement Part-Based Adjustment Priorities	194
5.1.4 Required Jigs, Tools and Like	196

5.2 Adjustments 197

5.2.1 Servicing Program Usage Outline	197
5.2.2 Head ID Input Function	199
5.2.3 CR motor drive torque dispersion measurement	199
5.2.4 PG Adjustment	200
5.2.5 Head Angular Adjustment	204
5.2.6 CR Tooth Skip Prevention Mechanism Adjustment	206
5.2.7 PF Adjustment	206
5.2.8 PW Sensor Adjustment	207
5.2.9 Bi-D Adjustment	208
5.2.10 Pixel Shift Adjustment	209
5.2.11 Cut Position Adjustment	210
5.2.12 USB ID Input	210
5.2.13 IEEE-1394 ID Input	211
5.2.14 First dot position adjustment (Left/Right Margin Adjustment)	211
5.2.15 A3+ Photo Quality Ink Jet Paper 2 Print Pattern Printing Function	212
5.2.16 A4 Plain Paper print check pattern	213

Chapter 6 Maintenance

6.1 Overview 215

6.1.1 ROM Replacement	215
6.1.2 Cleaning	215
6.1.3 Service Maintenance	216
6.1.4 Lubrication	217

Chapter 7 APPENDIX

7.1 Connector Summary 227

7.1.1 Connectors and Pin Layouts	227
7.1.2 EEPROM Address Map	231

7.2 Exploded Diagram 236

7.3 Parts List for EPSON Stylus Photo 2100 248

7.4 Circuit Diagram 253

CHAPTER

1

PRODUCTION DESCRIPTION

1.1 Overview

The Stylus PHOTO 2100/2200 is a photo printer designed for a wide range of users from individual users to commercial users. As a model to replace the Stylus PHOTO 2000P, this consumer high-end model is capable of pigment-independent CSIC, CD-R printing, and roll paper cutter functions. This product has the following features.

FEATURES

- High Color Print Quality
 - High photo quality thanks to Photo Mach technology
 - Achievement of higher quality using microwaves and super microwaves
 - High resolution printing of 2880 x 1440dpi
- Three Different Interfaces Supported
 - IEEE-1284 parallel interface
 - USB 2.0
 - IEEE-1394
- Windows/Macintosh Exclusive
- Multi-size Capable ASF
 - ASF equipped as standard supports forms ranging up to A3+.
- CSIC-compatible Independent Ink Cartridge
 - Three different ink sets, Photo-Black & Light-black, and Matte-Black & Light-black, can be changed.
- Newly Developed Pigment Ink
 - As compared to the conventional pigment ink, the color reproduction area of the new ink has increased up to about 80% of the dye ink, improving color development.
 - The concentration of YMC has been increased, and the Light-black ink adopted improves the Light-black balance and metamerism.

- Roll paper compatibility
- Thick paper/CD-R printing compatibility
- Auto cutter compatibility
- Frameless printing compatibility
- Two-sided printing compatibility

By addition of the standard-equipped CD-R print kit, direct printing can be done on a CD-R label.

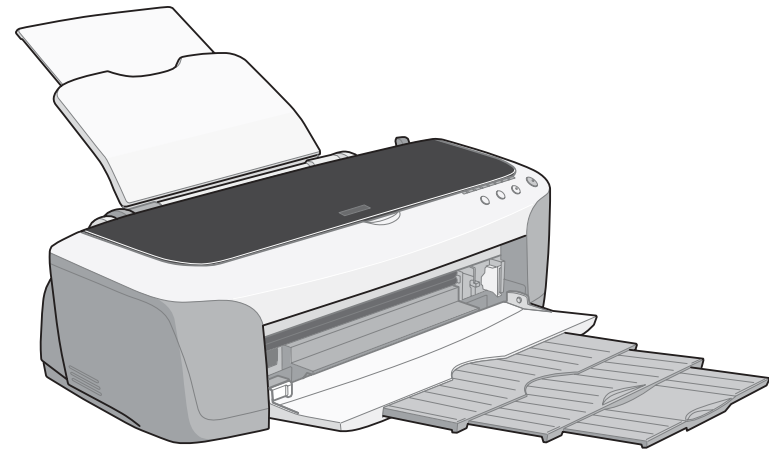


Figure 1-1. Product Appearance

1.2 Basic Specifications

1.2.1 Specification Outline Comparison

The following table gives the comparison of specifications between this product and similar conventional models.

Table 1-1. Specification Outline Comparison

	Item	Stylus PHOTO 950	Stylus PHOTO 2100/2200	Stylus PHOTO 2000P
	Location	Successor to PM-920C	Successor to Stylus PHOTO 2000P	No corresponding model
	Number of colors	7 colors (6 colors: 2 lines for BK, 1 line for each of C, LC, M, LM, Y)	7 colors (2 types for Bk + C, LC, M, LM, Y) Photo-Black & Matte-Black Matte-Black & Light-black	6 colors (Bk, C, Lc, M, Lm, Y)
	Resolution (H × V)	2880 × 1440	2880 × 1440	1440 × 720
	Cut sheet size	L/L2 size, A6 to A4	<ul style="list-style-type: none"> A6 to Super A3 Thickness : 0.08 to 0.11mm Envelope : #10, DL, C6 	<ul style="list-style-type: none"> A6 to Super A3 Thickness : 0.08 to 0.11mm Envelope : #10, DL, C6
	Roll paper compatibility	89/100/127/210mm width	89/100/210/329mm width	
Head	Number of Head	Monochrome and color integrated type		
	Head type (black)	G-Mach	G-Mach	E-Chips
	Nozzle arrangement	96 nozzles × 1 line	96 nozzles × 2 lines	48 nozzles × 1 line
	Nozzle pitch	180dpi	180dpi	120dpi
	Head type (color)	G-Mach	G-Mach	E-Chips
	Nozzle arrangement	96 nozzles × 6 lines	96 nozzles × 5 lines	48 nozzles × 5 lines
	Nozzle pitch	180dpi	180dpi	120dpi
	Delivery (ng)	VSD1 : 13.8 + 27.6 + 41.5 VSD2 : 5.4 + 9.5 + 23.0 VSD4 : 2.5	VSD1 : 13.8ng – 27.6ng – 41.5ng VSD2 : 4.5ng – 9.5ng – 23.0ng VSD4 : 4.5ng	ND :
	Head reliability/nozzle	3 billion shots/nozzle		

Table 1-1. Specification Outline Comparison

	Item	Stylus PHOTO 950	Stylus PHOTO 2100/2200	Stylus PHOTO 2000P
Ink cartridges	Ink type	Dye	Newly developed pigment	Pigment
	Ink cartridge type	Color-separated CSIC	Color-separated CSIC	Black, color-individual CSIC type
	I/C (T code : Overseas)	<ul style="list-style-type: none"> • T0331 (Bk) • T0332 (C) • T0333 (LC) • T0334 (M) • T0335 (LM) • T0336 (Y) 	<ul style="list-style-type: none"> • T0341 (Photo Bk) • T0342 (C) • T0343 (M) • T0344 (Y) • T0345 (LC) • T0346 (LM) • T0347 (Light Black) • T0348 (Matte Bk) 	<ul style="list-style-type: none"> • T015 (Bk) • T016 (Color)
	Ink fill amount (black)	18.3g +/- 0.5g	18.3g +/- 0.5g	
	Effective ink amount	14.4g or more	14.4g or more	
	Remaining ink amount	3.4g or less	3.4g or less	
	Cartridge weight (black)	42g/each color	42g/each color	
	Number of printable sheets (black) ISO/IEC 10561 Letter at 360dpi	570 pages (360dpi, A4)	T.B.D	
	Black ink end detection	Dot counter (software counter)		
	Ink fill amount (color)	18.3g +/- 0.5g (Y/M/C/Lc/Lm)	18.3g +/- 0.5g (C/LC/M/Lm/Y)	
	Effective ink amount	14.4g or more (Y/M/C/Lc/Lm)	14.4g or more (C/LC/M/Lm/Y)	
	Remaining ink amount *1 : Y/M/C, *2 : Lc/Lm	3.4g or less (Y/M/C/Lc/Lm)	3.4g or more (C/LC/M/Lm/Y)	
	Cartridge weight (color)	42g/each color	42g/each color	
	Number of printable sheets (black) ECOMA ISO 10561 5% duty	TBD (360dpi, A4)	T.B.D	
	Color ink end detection	Dot counter (software counter)		

Table 1-1. Specification Outline Comparison

	Item	Stylus PHOTO 950	Stylus PHOTO 2100/2200	Stylus PHOTO 2000P
Mechanism outline	Maximum number of print digits (10CPI)	86.97 digits	127 digits	
	Number of motors *1 : Optional cutter	4 motors (CR, PF, Pump, Cutter *1)	4 motors (CR, PF, Pump, Cutter *1)	3 motors (ASF, CR, PF)
	CR motor armature resistance	23.0Ω +/- 25% (with DC brushes)	23.0Ω +/- 25% (with DC brushes)	31.1Ω +/- 25% (with DC brushes)
	ASF/PUMP motor winding resistance	10.0Ω +/- 10% : Per phase (PM stepping)	7.0Ω +/- 10% : Per phase (PM stepping)	10.4Ω +/- 10% : Per phase (PM stepping)
	PF motor armature resistance (ASF)	22.3Ω +/- 25% (with DC brushes)	23.0Ω +/- 25% (with DC brushes)	31.1Ω +/- 25% (with DC brushes)
	Platen gap	1.35mm +/- 0.1mm	1.2mm +/- 0.1mm	1.14mm +/- 0.1mm
	Reliability (except head)	5 years or black: 25000 pages, or color: 10000 pages		
	Operation noise (ISO 7779)	45dB (A)		
	Paper feeder	<ul style="list-style-type: none"> • ASF (Top entry front out) • Roll paper feeder • Matte board paper feeder • CD-R printing tray 		ASF (Top entry front out)
	External dimensions (W × D × H) *1 : When tucked *2 : When used	<ul style="list-style-type: none"> • 515 × 332.8 × 209mm *1 • 515 × 526.3 × 229.4mm *2 (Cutter not included) 	<ul style="list-style-type: none"> • 631 × 320 × 205mm *1 • 631 × 931 × 357mm *2 (Cutter not included) 	<ul style="list-style-type: none"> • 609 × 311 × 175mm *1 • 609 × 766 × 414mm *2
Weight	<ul style="list-style-type: none"> • 7.25kg (printer alone) • Cutter: 950g 	<ul style="list-style-type: none"> • 11.7kg (printer alone) • Cutter: 1.4kg 	8.4kg	

Table 1-1. Specification Outline Comparison

	Item	Stylus PHOTO 950	Stylus PHOTO 2100/2200	Stylus PHOTO 2000P
Sensors	CR encoder	Linear scale + encoder sensor		
	PF encoder	Loop scale + encoder sensor		
	PE detector	Transparent photo interrupter		
	PE detector (rear)	-	-	-
	PG detector	Mechanical contact (2 pcs.)		-
	Paper leading edge/ paper width detector (PW sensor)	Transparent photo interrupter		-
	I/C detector	CSIC		
	ASF HP detector	Clutch detection	Transparent photo interrupter	
	CDR tray detector	Also used as PF sensor	Mechanical contact	-
	Cutter CR position detector	Transparent photo interrupter	Transparent photo interrupter (2 pcs.)	-
Main board	Control code	ESCP/2		
		ESCP remote		
	Interface	Panel (IEEE1284.4 compatibility)		
		USB	USB (2.0 compatibility)	USB
		-	IEEE1394 (400Mbps)	-
	USB (transfer speed)	12Mbps	12Mbps to 480Mbps	12Mbps
	Main board	C456Main-B	C387Main	C304Main/C298Main-B
	Input buffer	256KB	112KB	256KB
	PROM application	Program	Program & 2 Tables (PC437, PC850)	Program & 2 Tables (PC437, PC850)
	PROM type	SOJ	SOJ, 8Mbit, 3.3V	DIC, 8M, 3.3V
	Backup battery	Installed	Installed	Installed
Backup battery type	Capacitor	Capacitor	Lithium battery	
Backup battery life	1 week (electricity accumulated every power-on)	1 week (electricity accumulated every power-on)	5 years	
Power board	Power board	C456PSB/PSE	C387PSB/PSE	C298PSB/PSE
	Power switch	Push switch with locking function		
	Output voltage	42V/5V		
Panel board	Panel board	C456PNL	C387PNL	C304PNL

Table 1-1. Specification Outline Comparison

	Item	Stylus PHOTO 950	Stylus PHOTO 2100/2200	Stylus PHOTO 2000P
Adjustment	Market initial setting information	EEPROM write	EEPROM write	EEPROM write
	Head ID input	19 digits (21 digits on label)	25 digits	14 digits
	Head inclination adjustment	Mechanical lever inside CR		
	Head height adjustment	No		
	Bi-D adjustment	EEPROM write		
	USB ID input	18 digits (10 digits for input from adjustment program)		
	IEEE1394 ID input	-	5 digits	-
	Platen gap	1.27mm +/- 0.1mm	1.2mm +/- 0.1mm Main shaft/sub shaft adjustment jig necessary	1.14mm +/- 0.1mm
	Pixel Shift Adjustment	-	EEPROM write	-
	Printout position adjustment (CR scanning direction)	EEPROM (value basically fixed to each model)		
	CR Measurement	EEPROM automatic write	EEPROM automatic write	-
	CR motor drive torque dispersion measurement	EEPROM write	EEPROM write	-
	PF Adjustment (Band feed adjustment)	-	EEPROM write	-
	Top margin adjustment	EEPROM (value basically fixed to all models)		
	PW sensor mounting position adjustment	-	EEPROM write	-
PF backlash adjustment	No (PF motor fixing screw tightening order predetermined)	No (PF motor fixing screw tightening order predetermined)	Yes (within 0.1mm of standard)	
Maintenance	Lubricating oil/ grease	G-26	G26/G45/G56	G-26
		O-12		
	Waste ink pad	47325 points	60352 points	33900 points

1.2.2 Paper Specification

1.2.2.1 Cut Sheet (Anti-EPSON special media)

Table 1-2. Cut Sheet

Paper size	Paper width mm (inch)	Paper length mm (inch)	Quality	Thickness mm (inch)	Weight g/m ² (lb)
A3	297	420	Plain paper, Bond paper	0.08 to 0.11 (0.003 to 0.004)	64 to 90 (17 to 24, 55 to 78)
A4	210	297			
A5	148	210			
A6	105	148			
B4	257	364			
B5	182	257			
Letter	216	279			
Half letter	139.7	215.9			
Legal	216	356			
Executive	184.2	266.7			



- No wrinkled, scuffed, torn or folded paper be used.
- No curled paper more than 5mm be used.

1.2.2.2 Envelope (Anti-EPSON special media)

Table 1-3. Envelope

Paper size	Paper width mm (inch)	Paper length mm (inch)	Quality	Weight (g/m ²)
#10 ^{*a}	241.3	104.8	Bond paper, PPC, Air mail	45 to 75 (12 to 20lb)
DL ^{*a}	220	110		
C6 ^{*a}	162	114		
220 × 132	220	132		

^{*a} :The longer side has a flap that has been folded.



- For use in general room temperature environment only.
- No wrinkled, scuffed, torn or folded paper be used.
- No curled paper more than 5mm be used.
- No envelopes glued in the flap and others be used.
- No doubled/windowed envelopes be used.

1.2.2.3 EPSON Special media

Quality: EPSON specifically designed media for ink jet printers

Table 1-4. EPSON Special media

EPSON Special media	Paper size	Paper width mm (inch)	Paper length mm (inch)	Quality mm	Weight g/m ² (lb)	ASF setting	Support sheet
Photo Quality Ink Jet Paper 2	Super A3	329	483	0.11	92(24)	65	×
	A3	297	420			65	×
	A4	210	297			65	×
	B5	182	257			65	×
Archival Matte Paper	Super A3	329	483	0.25	189(50)	10	○
	A3	297	420			10	○
	A4	210	297			20	○
	Roll type	89	7m			-	-
100		8m	-	-			

Table 1-4. EPSON Special media

EPSON Special media	Paper size	Paper width mm (inch)	Paper length mm (inch)	Quality mm	Weight g/m ² (lb)	ASF setting	Support sheet
Premium Glossy Photo paper	Super A3	329	483	0.27	255(68)	1	×
	A3	297	420			1	×
	A4	210	297			20	×
	Roll type	89	7m			-	-
		100	8m			-	-
		127	8m			-	-
		210	10m			-	-
		329	10m			-	-
Glossy Paper-Photo Weight	Super A3	329	483	0.22	217(58)	1	×
	A3	297	420			1	×
	A4	210	297			1	×
Watercolor Paper-Radiant White	Super A3/B	329	483	0.29	190(51)	1	×
Matte Board	A4	210	297	1.28	1100(293)	-	×
Premium Ink Jet Plain Paper	A4	210	297	0.11	80(21)	100	×
Bright White Ink Jet Paper (Bond Paper)	A3	297	420	0.13	92.5(25)	100	×
	A4	210	297			100	×

Table 1-4. EPSON Special media

EPSON Special media	Paper size	Paper width mm (inch)	Paper length mm (inch)	Quality mm	Weight g/m ² (lb)	ASF setting	Support sheet
Matte Paper-Heavyweight	Super A3/B	329	483	0.23	167(44)	10	○
	A3	297	420			10	○
	A4	210	297			20	○
	Roll type	89	7m			-	-
		100	8m			-	-
		127	8m			-	-



- For use in general room temperature environment only.
- No wrinkled, scuffed, torn or folded paper be used.
- No curled paper more than 5mm be used.
- Paper characteristics conform to the medium delivery specification.
- The CD-R exclusive tray should be handled like board paper.

1.2.3 Printing Area

□ The printing area guaranteed for this printer is shown below.

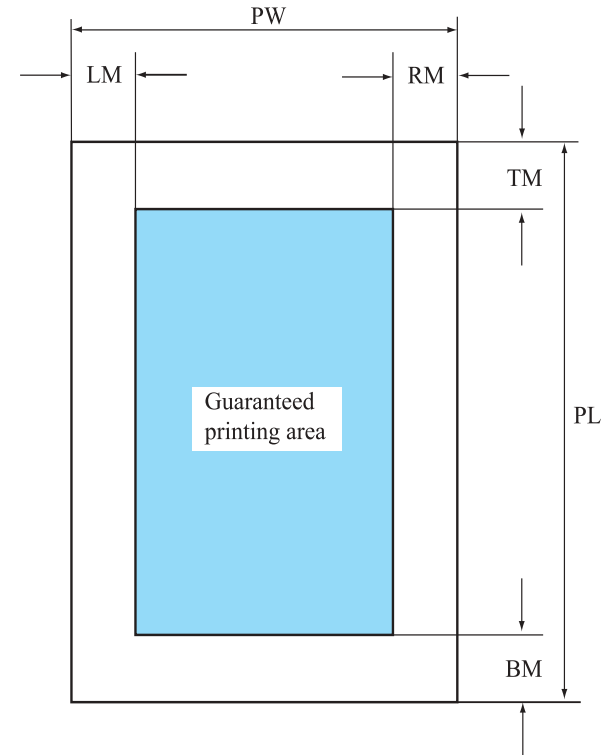


Figure 1-2. Printing Area

Table 1-5. Printing Area (mm) of Stylus PHOTO 2100/2200

Paper size	PW (paper width)	PL (paper length)	LM (Left margin)	RM (Right margin)	TM (Top margin)	BM (Bottom margin)
A3 Wide	329	483	3 *a	3 *a	3 *b	14/3 *b*c
A3	297	420	3 *a	3 *a	3 *b	14/3 *b*c
US Legal	216	356	3 *a	3 *a	3 *b	14/3 *b*c
US Letter (Landscape)	216	279	3 *a	3 *a	3 *b	14/3 *b*c
US Letter (Portrait)	279	216	3 *a	3 *a	3 *b	14/3 *b*c
A4	210	297	3 *a	3 *a	3 *b	14/3 *b*c
B5	182	257	3 *a	3 *a	3 *b	14/3 *b*c
Photo Card (4" x 6")	113.6	175.4	3 *a	3 *a	3 *b	14/3 *b*c
Roll paper	-	-	3 *a	3 *a	20*b	14

*a : Under specific conditions, the left and right margins can be zeroed.
 *b : Under specific conditions, the top and bottom margins can be zeroed.
 *c : When the paper length is specified with the ESC (S command, the bottom margin can be reduced to the minimum of 3mm. However, printing quality may decline in the range 3mm to 14mm from the paper bottom. When the paper length is not specified, the bottom margin remains unchanged from 14mm or more.

□ Printing area (Cut sheet)

■ Printable area

The range made of the printable area A and printable area B shown in Figure 1-3. In the printable area B, printing quality may decline. The image quality levels of the printing areas A, B are defined in the quality standard.

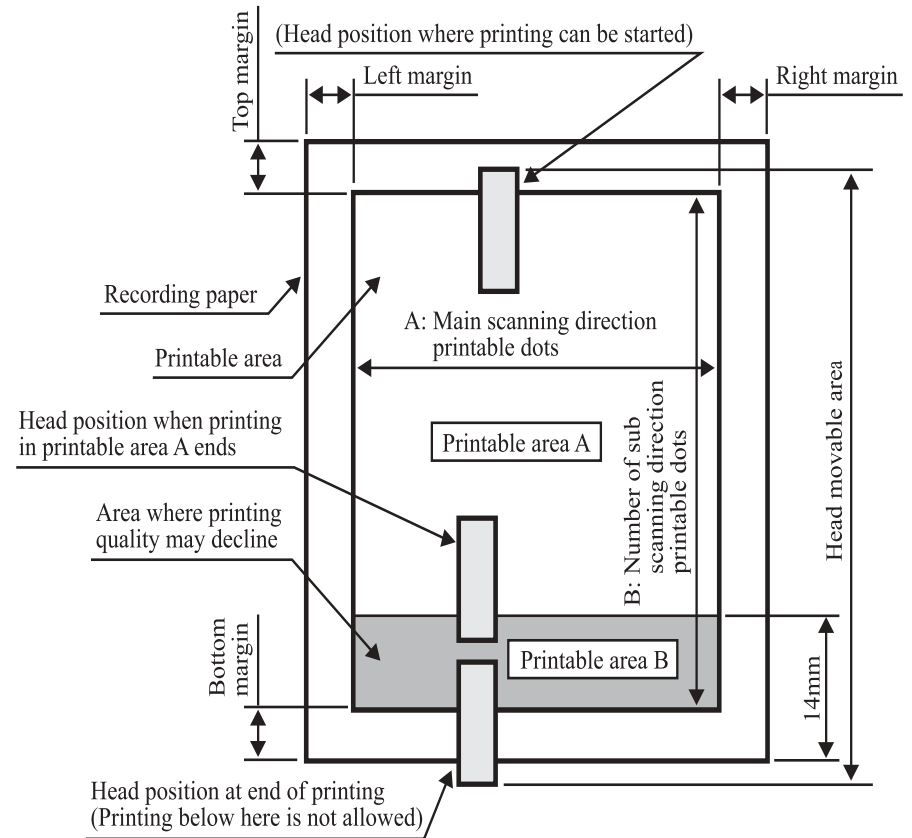


Figure 1-3. Printing Area

■ Printable area (Margin-less printing)

The range made of the printable areas A and B and the top, bottom, left and right off-range printing areas C shown in Figure 1-4. The image quality levels of the printing areas A, B are defined in the quality standard. The printing areas C are trimmed areas, where printing may not be done. Note that the paper width is limited to 89, 100, 127, 210 or 329mm or to 4, 5, 8, or 8.5 inches.

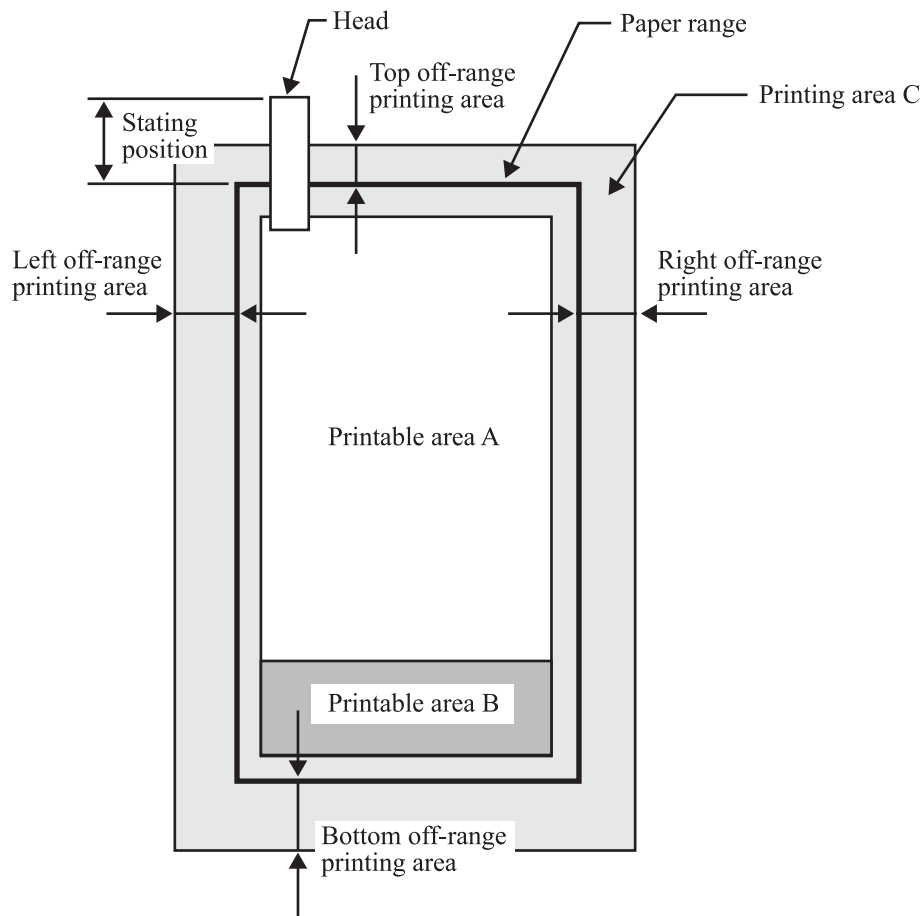


Figure 1-4. Printing Area (Margin-free Printing)

- Starting position : 85/360 (6mm)
- Off-range printing areas

Table 1-6. Off-range Printing Areas

	Size Less than in Right Field	11inch/A3/A3+
Top	42/360 (3mm)	42/360 (3mm)
Left, right	36/360 (2.5mm)	49/360 (3.5mm)
Bottom	72/360 (5mm)	72/360 (5mm)

■ Head movable areas

Set the head movable areas (areas where the nozzles may come out of the printing range) relative to the printing area in the sub scanning direction (paper feeding direction). Those areas are as shown in Figure 1-5 to Figure 1-9. The main scanning direction (carriage direction) is as shown in the A0 carriage operation area diagram.

1) Top head movable area

1. At the setting of top margin to 3mm or more

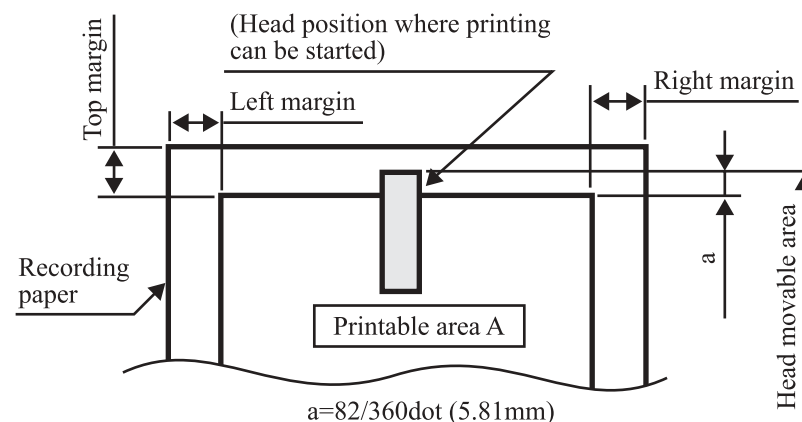
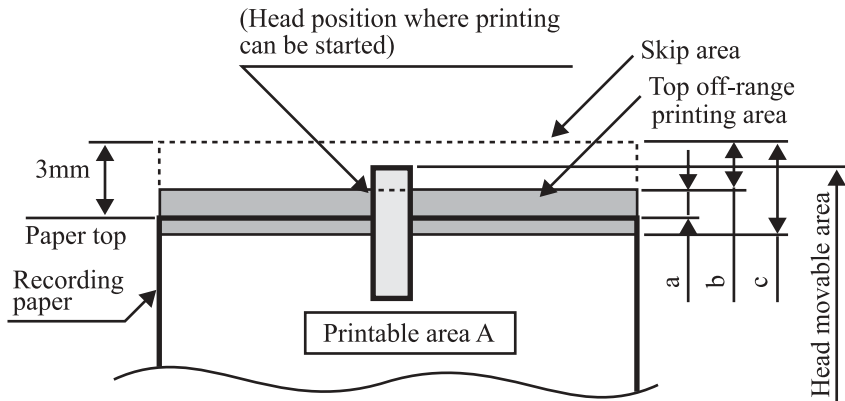


Figure 1-5. Head Movable Area for 3mm Top Margin

2. At the setting of top margin to 0mm

Top off-range printing prints the area a, and nozzle-restricted printing prints the area c. After the #1 nozzle has passed through the area c, nozzle restriction is canceled.



Paper Type	Exclusive Paper	Other than Exclusive Paper	Any Paper Type
Recording paper width (Main scanning method)	Less than 150mm	Less than 150mm	150mm or more
a = Off-range printing area	25/360 (1.76mm)	25/360 (1.76mm)	38/360 (2.68mm)
b = Skip amount	17/360 (1.20mm)	17/360 (1.20mm)	4/360 (0.28mm)

c = 66/360 (4.7mm) Nozzle-restricted printing area

#1 to #22 A total of 22 nozzles Nozzle restriction

Figure 1-6. Head Movable Area for 0mm Top Margin

- 2) Bottom head movable area

1. At the setting of bottom margin to 14mm

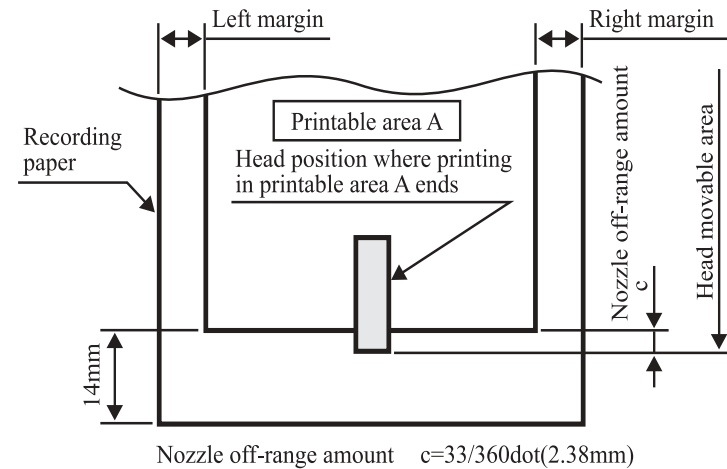


Figure 1-7. Head Movable Area for 14mm Bottom Margin

2. At the setting of bottom margin to 3mm

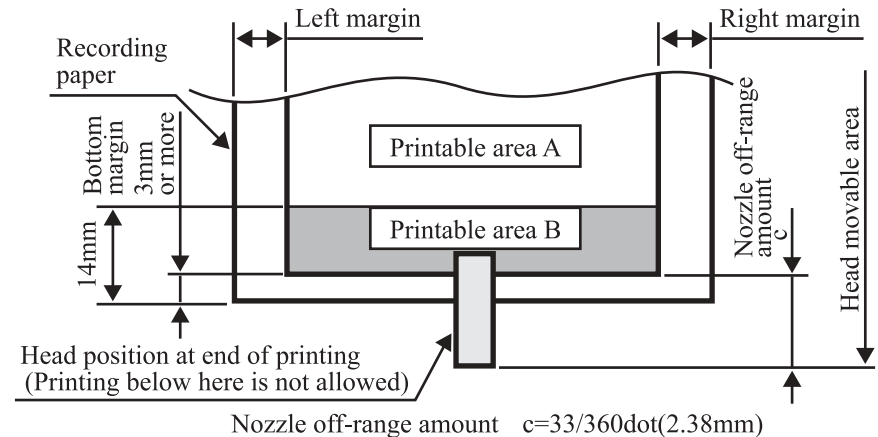
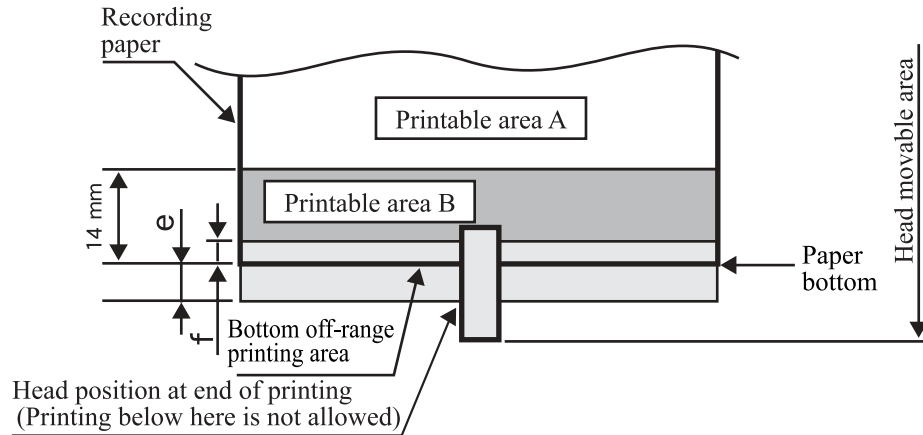


Figure 1-8. Head Movable Area for 3mm Bottom Margin

- 3. At the setting of bottom margin to 0mm

Since printing is restricted in the bottom off-range area (e) after the distance f from the paper bottom, only a total of 14 nozzles, #66 to #79, are used per nozzle line to perform printing.



e = Described in override mask position.
 f = 42/360 (3mm) Nozzle-restricted printing area
 #66 to #79 Total of 14 nozzles Nozzle restriction

Figure 1-9. Head Movable Area for 0mm Bottom Margin

- Printing area (Roll paper)

- Printing area

The range made of the printable area A or printing areas A + C shown in Figure 1-10. Note that printing in the range of printing areas A + C is limited to the paper width 89, 100, 127, 210 or 329mm or to 4.5 inches.

- Head movable area

Set the head movable area (area where the head may come out of the printing range) relative to the printing area in the paper feeding direction. This area is as shown in Figure 1-10 (roll paper).

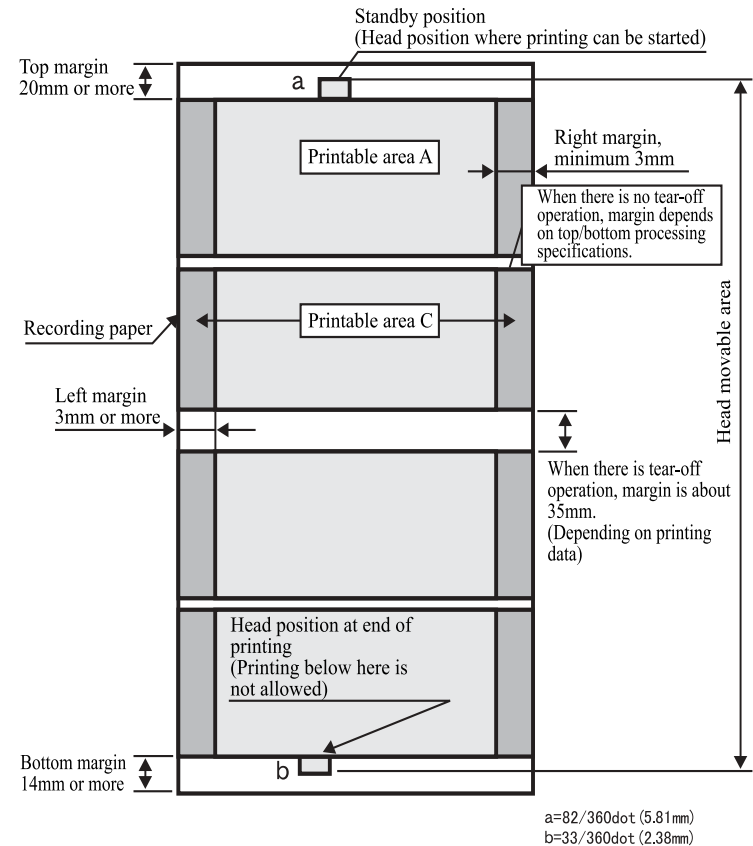


Figure 1-10. Printing Area Diagram (Roll Paper)

□ Printing area (CD-R)

■ Printing area

Figure 1-11 shows a CD-R printing area. The printing area is in the inside of $\phi 116$ and in the outside of $\phi 43$.

1. The reference position of the carriage main scanning direction is 141mm away from the center of a CD-R toward the home position. (The center of the CD-R is identified by automatic detection.)
2. The reference position of the paper feeding direction is 139mm below the center of the CD-R.
3. The CD-R center cannot be reversed more than 74mm from the head #1 nozzles.

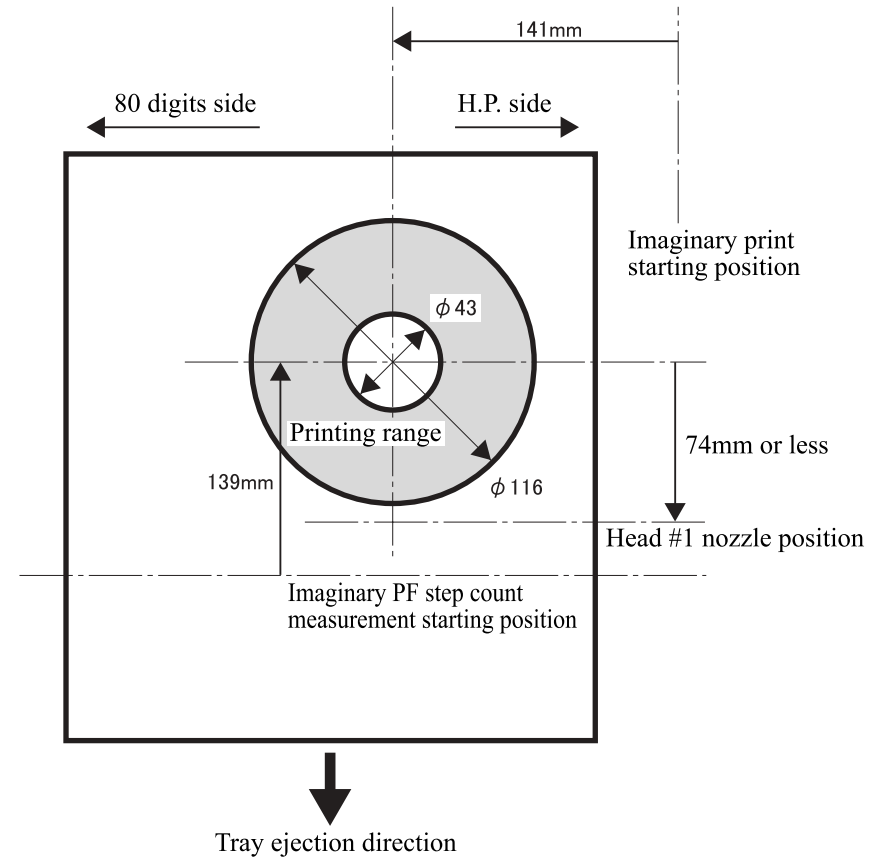


Figure 1-11. Printing Area Diagram (CD-R)

1.2.4 Ink Type-based Medium Compatibility Specifications

On this product, the compatible media change depending on the black ink combination. PIM compatibility also changes depending on the medium. The following describes the compatible media, used LUT, and PIM compatibility that change depending on the black ink combination.

- Photo-black + Light-black: Glossy
Standard ink combination/ink combination adequate for photo printing

Table 1-7. Photo-black + Light-black

Paper Type	Support	Used LUT	Driver UI Description		PIM Support
			US	Other	
Plain Paper	○	Plain Paper	Plain Paper	Plain Paper	○
Premium Ink Jet Plain Paper	○	Plain Paper	×	×	○
Bright White Ink Jet Paper	○	Plain Paper	×	×	○
Premium Luster Photo Paper (for U.S only)	○	Premium Semigloss photo paper	Premium Luster Photo Paper	×	○
Premium Semigloss photo paper	○	Premium Semigloss photo paper	Premium Semigloss photo paper	Premium Semigloss photo paper	○
Premium Glossy Photo Paper (for U.S only)	○	Premium Semigloss photo paper	Premium Semigloss photo paper	×	○
Glossy Paper-Photo Weight (Except U.S)	○	Glossy Paper-Photo Weight	×	Glossy Paper-Photo Weight	○
Archival Matte Paper	○	Archival Matte Paper	Archival Matte Paper	Archival Matte Paper	○

Table 1-7. Photo-black + Light-black

Paper Type	Support	Used LUT	Driver UI Description		PIM Support
			US	Other	
Velvet Fine Art Paper (for U.S only)	○	Archival Matte Paper	Velvet Fine Art Paper	×	○
Watercolor Paper-Radiant White	○	Watercolor Paper-Radiant White	Watercolor Paper-Radiant White	Watercolor Paper-Radiant White	○
CD-R	×	-	-	-	-
Photo Quality Ink Jet Paper	×	-	-	-	-
Matte Paper-Heavyweight	×	-	-	-	-
Photo Paper	×	-	-	-	-
Photo Quality Glossy Film	×	-	-	-	-
Ink Jet Transparencies	×	-	-	-	-
Iron-On Cool Peel Transfer Paper	×	-	-	-	-
Ink Jet Backlight Film	×	-	-	-	-
Canvas	×	-	-	-	-
360dpi Ink Jet Paper	×	-	-	-	-

- Matte-black + Light-black: Matte-black is optional.
Good-looking ink combination for plain paper/matte-Light-black media

Table 1-8. Matte-black + Light-black

Paper Type	Support	Used LUT	Driver UI Description		PIM Support
			US	Other	
Plain Paper	○	Plain Paper	Plain Paper	Plain Paper	○
Premium Ink Jet Plain Paper	○	Plain Paper	×	×	○
Bright White Ink Jet Paper	○	Plain Paper	×	×	○
Premium Luster Photo Paper (for U.S only)	×	-	-	-	-
Premium Semigloss photo paper	×	-	-	-	-
Premium Glossy Photo Paper (for U.S only)	×	-	-	-	-
Glossy Paper-Photo Weight (Except U.S)	×	-	-	-	-
Archival Matte Paper	○	Archival Matte Paper	Archival Matte Paper	Archival Matte Paper	○
Velvet Fine Art Paper (for U.S only)	○	Archival Matte Paper	Velvet Fine Art Paper	×	×
Watercolor Paper-Radiant White	○	Watercolor Paper-Radiant White	Watercolor Paper-Radiant White	Watercolor Paper-Radiant White	○
CD-R	×	-	-	-	-

Table 1-8. Matte-black + Light-black

Paper Type	Support	Used LUT	Driver UI Description		PIM Support
			US	Other	
Photo Quality Ink Jet Paper	×	-	-	-	-
Matte Paper-Heavyweight	×	-	-	-	-
Photo Paper	×	-	-	-	-
Photo Quality Glossy Film	×	-	-	-	-
Ink Jet Transparencies	×	-	-	-	-
Iron-On Cool Peel Transfer Paper	×	-	-	-	-
Ink Jet Backlight Film	×	-	-	-	-
Canvas	×	-	-	-	-
360dpi Ink Jet Paper	×	-	-	-	-

NOTE: When the PIM incompatible medium is selected, the "some PRINT IMAGE Matching functions are not applied" message appears on bottom right of the paper selection screen.

1.2.5 Release Lever

On this printer, set the Release lever as indicated in the following table depending on the used paper type.

Table 1-9. Release lever Setting

Paper	Release lever Position	Gap Correction
Cut sheet, OHP, Label, Roll paper	Front side position	0mm
Envelope, Board paper	First step from front position	+1.3mm
CD-R tray ^{*a}	Second step from front position	+2.7mm
-	Far side position ^{*b}	-

^{*a} : When the CD-R tray is loaded, any position other than the second step from the front position will result in a release lever error.

^{*b} : The far side position of the Release lever is used when placing thick paper (board paper) or CD-R tray. After placing thick paper or CD-R tray, move the release lever to the appropriate position.



<Front side position>



<First step from front position>



<Second step from front position>



<Far side position>

Figure 1-12. Release Lever Positions

1.3 Functions

1.3.1 Control Panel

The appearance of the control panel is shown below.

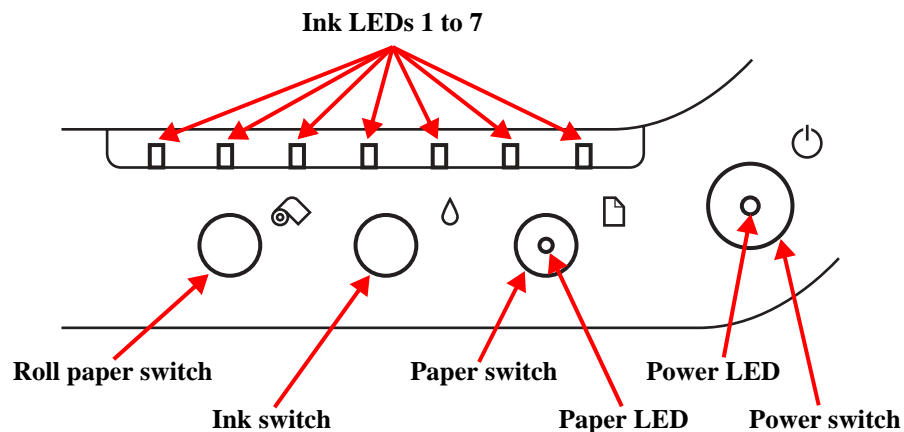


Figure 1-13. Control Panel Appearance

1.3.2 Switches

- Power switch
- Paper switch
- Ink switch
- Roll paper switch

1.3.3 Indicators

- Power LED : Green
- Paper LED : Red
- Ink LEDs (1 to 7) : Red

1.3.4 Switch Functions

FUNCTIONS IN NORMAL STATUS

Table 1-10. Normal-status Functions

Switch		Function
Power switch		<ul style="list-style-type: none"> • Power on/off • Panel reset ^{*a}
Paper switch		<ul style="list-style-type: none"> • Paper feed (Error is reset when paper is fed successfully) • Paper ejection • Movement from cartridge replacement position to home position
Ink switch		<ul style="list-style-type: none"> • Cleaning ^{*b} • Movement to cartridge replacement position • Movement from cartridge replacement position to home position
Roll paper switch	Without cutter	<ul style="list-style-type: none"> • Tear Off execution/return from Tear Off • Roll paper ejection (back-out) ^{*b} • Movement from cartridge replacement position to home position
	With cutter	<ul style="list-style-type: none"> • Roll paper ejection (back-out) ^{*b} • Movement from cartridge replacement position to home position

*a : Turn on the power switch within 10 seconds.

*b : Hold down the switch for 3 seconds.

FUNCTIONS AT POWER-ON

Table 1-11. Power-on Functions

Switch	Function
Paper switch	Status printing ^{*a}
Ink switch	Roller cleaning mode ^{*b}
Roll paper switch	Code Page/parallel interface 1284.4 operation mode selection ^{*c}
Paper switch + Roll paper switch	Special setting mode ^{*d}

^{*a} : Any of the following operations is performed according to the value written to 5BH of the EEPROM. For details, refer to "Status Printing" on Page 30.

00h	Firmware version, selected Code Page, Waste ink counter and nozzle test pattern are printed.
01h	Hexadecimal dump mode

^{*b} : For details, refer to "Panel Operation in Roller Cleaning Mode" on Page 34.

^{*c} : For details, refer to "Default Setting Selection Function" on Page 28.

^{*d} : For details, refer to "Special setting mode" on Page 27.

SPECIAL SETTING MODE

To select the special setting mode, hold down the Paper switch and Roll paper switch and switch power on, and then press the following switches within the time when the Paper error indicator is blinking (for about 3 seconds).

Table 1-12. Special Setting Mode ^{*a}

Switch	Function
Paper switch	EEPROM and Timer IC reset ^{*b}
Roll paper switch (10 seconds)	Waste ink counter reset ^{*c}

^{*a} : This operation resets the following data at the corresponding addresses of the EEPROM.

- 26<H>-27<H> Last cleaning time: 00<H>, 00<H>
- 28<H>-29<H> Power off time: 00<H>, 00<H>
- 44<H> Interface selection: 00<H> (Auto)

^{*b} : For the initialized items, refer to "EEPROM Address Map" on Page 231.

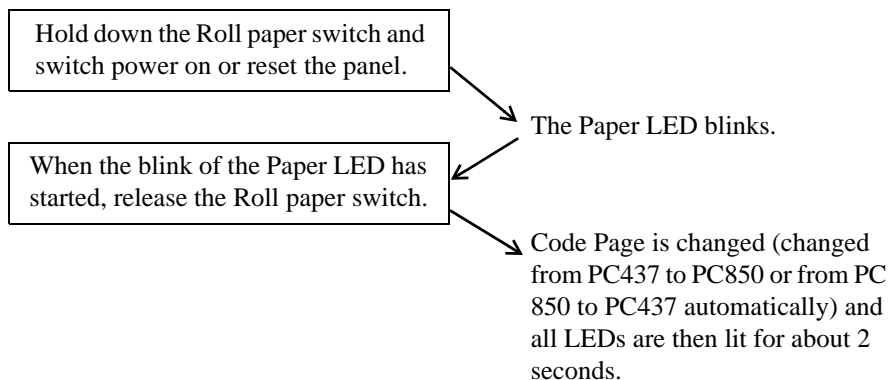
^{*c} : The corresponding addresses of the EEPROM are 20<H>-21<H>.

1.3.5 Default Setting Selection Function

CODE PAGE SELECTION FUNCTION

By operating the panel at power-on, you can select the default character code table.

Operating procedure



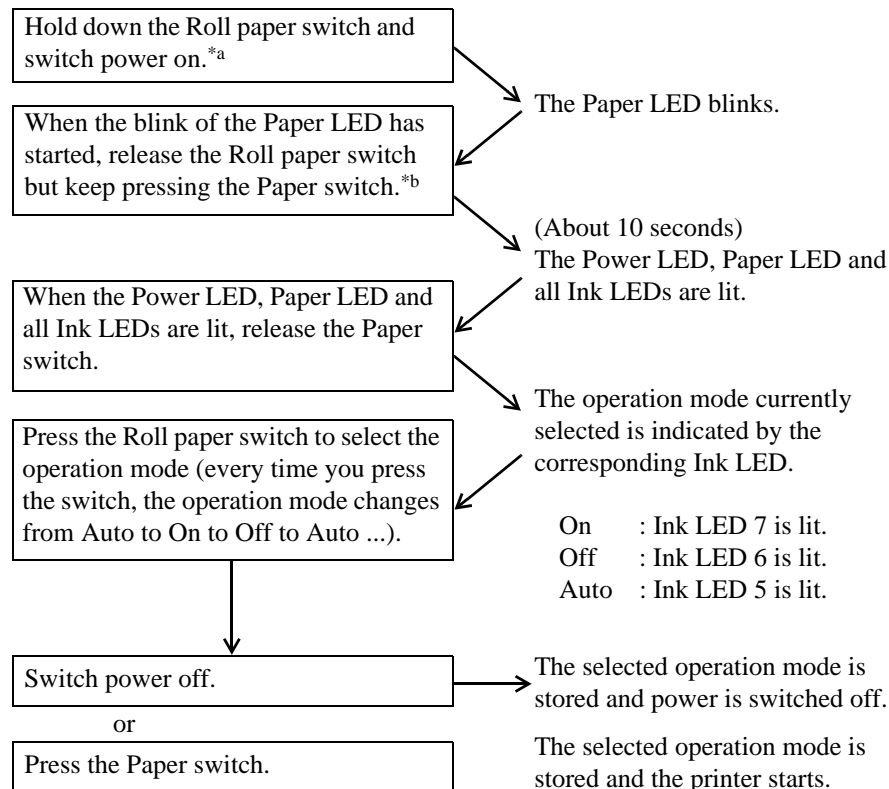
Confirmation of the current Code Page

The currently selected Code Page can be confirmed by performing status printing.

PARALLEL INTERFACE 1284.4 OPERATION MODE SELECTION

By operating the panel at power-on, you can select the operation mode (On/Off/Auto) of the IEEE1284.4 protocol in the parallel interface.

Operating procedure



*a : By initializing the panel, you cannot select the 1284.4 operation mode. To avoid panel initialization, the power must be left off for more than about 10 seconds or the power plug must be disconnected from the receptacle once with power off.

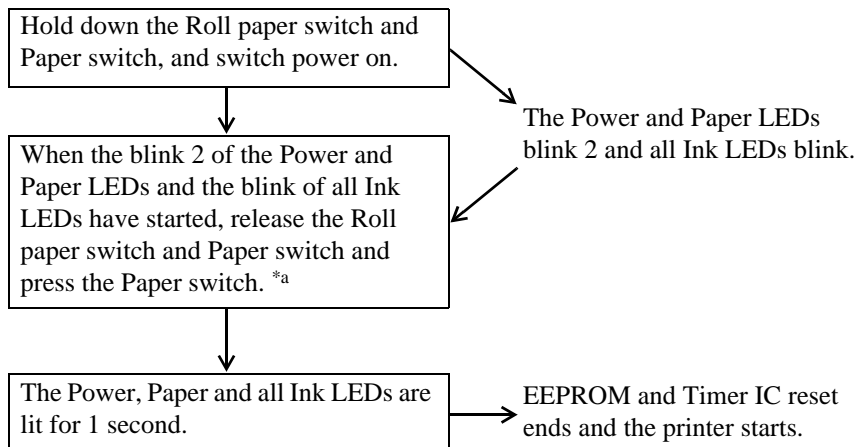
*b : Note that if you do not press any switch for 2 or more seconds after you released the Roll paper switch, Code Page selection will be executed.

1.3.6 Special Setting Mode Function

EEPROM AND TIMER IC RESET

By operating the panel at power-on, you can reset the EEPROM and Timer IC.

Operating procedure

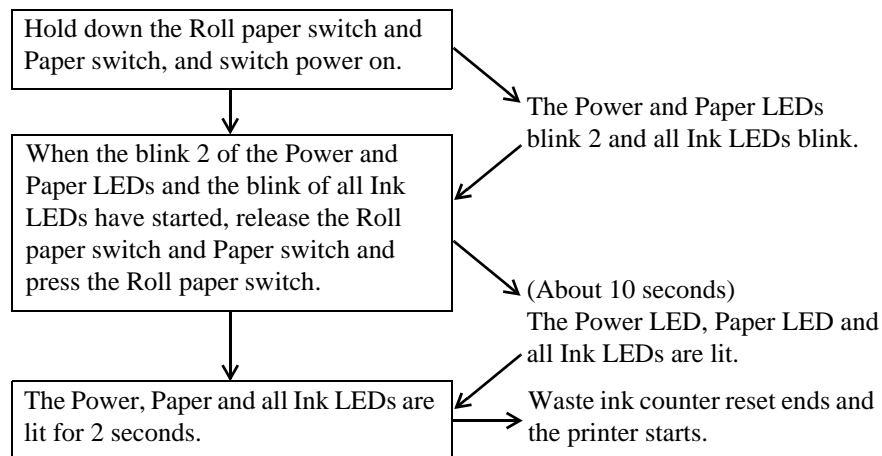


*a : If the switch is not pressed within the time when the Error LED is blinking (for 3 seconds), the printer starts normally.

WASTE INK COUNTER RESET

By operating the panel at power-on, reset the counter for waste ink.

Operating procedure



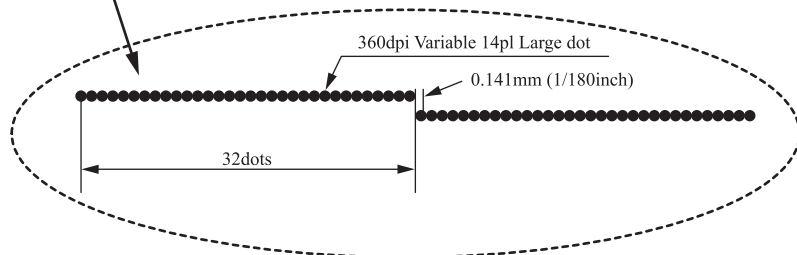
1.3.7 Status Printing

PRINTING METHOD

- Printing using remote command
Use the NC command of the remote commands.
- Status printing
Hold down the Paper switch and switch power on.
- Printing using D4 control command
On the D4 command channel, send the "nc" command.

PRINTING RESULT DETAILS

<Photo-Black /Matte-Black>	<Cyan>	<Magenta>	<Yellow>	<Light Cyan>	<Light Magenta>	<Gray/ Matte-Black>
1 13	1 13	1 13	1 13	1 13	1 13	1 13
25 24	25 24	25 24	25 24	25 24	25 24	25 24
37 36	37 36	37 36	37 36	37 36	37 36	37 36
49 48	49 48	49 48	49 48	49 48	49 48	49 48
61 60	61 60	61 60	61 60	61 60	61 60	61 60
73 72	73 72	73 72	73 72	73 72	73 72	73 72
85 84	85 84	85 84	85 84	85 84	85 84	85 84
96 96	96 96	96 96	96 96	96 96	96 96	96 96



NOTE: The values above the lines indicate nozzle numbers and are not printed actually.

NOTE: Differences between the character strings printed in panel Nozzle Check pattern and driver Nozzle Check pattern (For the driver, the firmware version and CPU mask version are also printed at top left of the print result paper.)

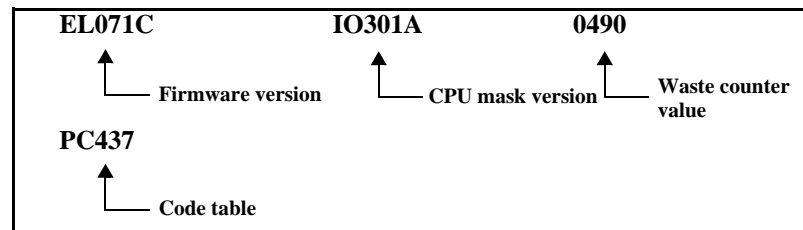


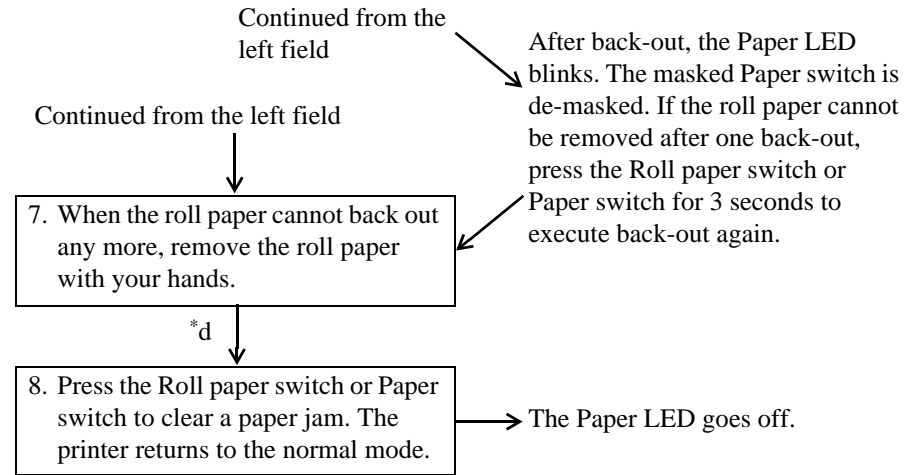
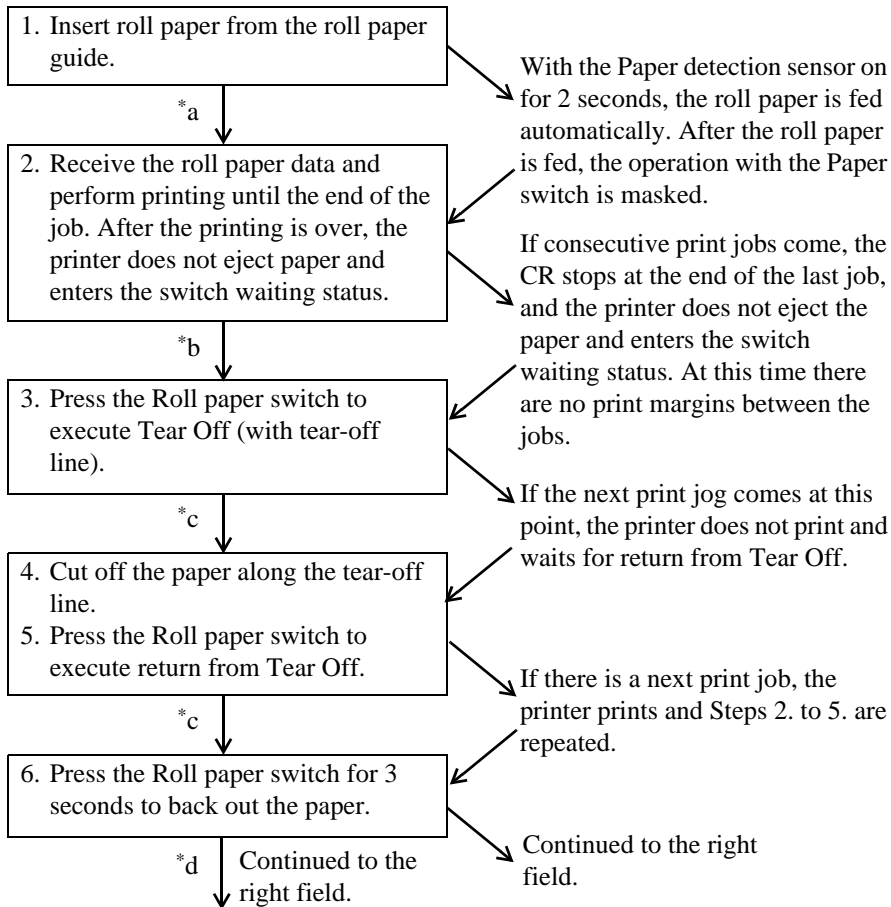
Figure 1-14. Printed Character Strings

1.3.8 Panel Operation for Roll Paper Printing

PANEL OPERATION IN ROLL PAPER MODE (WITHOUT CUTTER, TEAR-OFF LINE PRINTING)

To shift to the paper roll mode, use the roll paper mode selection command of the remote commands.
The following indicates the basic panel operating procedure for printing on roll paper.

Operating procedure



- *a : If power is switched off at this point, the panel feeding status is stored onto the EEPROM. When power is switched on again, the printer does not eject paper. The operation in Step 2. and later can be performed.
- *b : If power is switched off at this point, the roll paper mode status is stored onto the EEPROM. When power is switched on again, the printer does not eject paper. The operation in Step 3. and later can be performed.
- *c : If power is switched off at this point, the roll paper mode status is stored onto the EEPROM. When power is switched on again, the printer does not eject paper. The operation that follows can be performed.
- *d : If power is switched off at this point, the roll paper mode is canceled and the panel feeding cancel is stored. When power is switched on again next, the printer enters the normal mode.

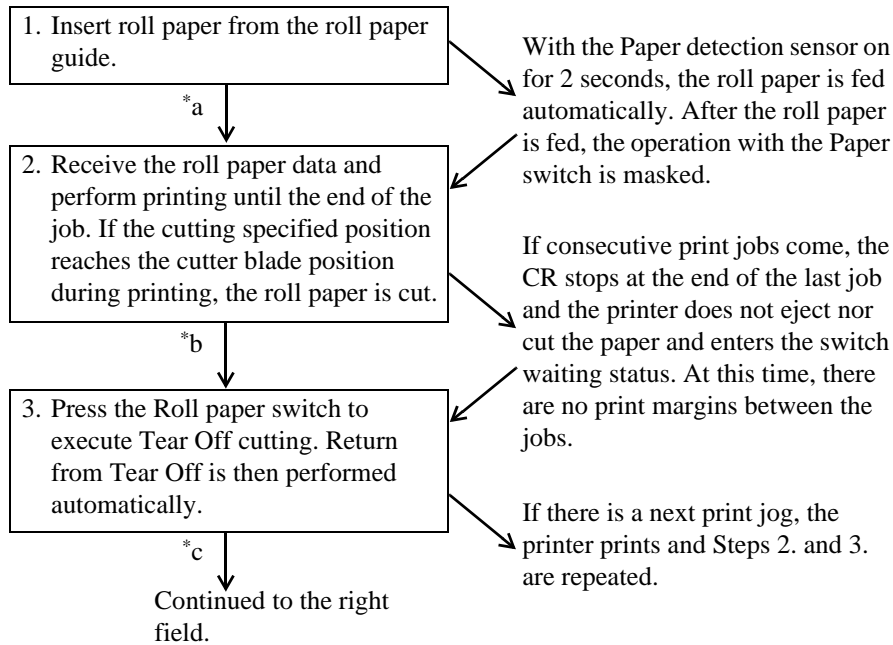
PANEL OPERATION IN ROLL PAPER MODE (WITH CUTTER)

To shift to the paper roll mode, use the roll paper mode selection command of the remote commands.

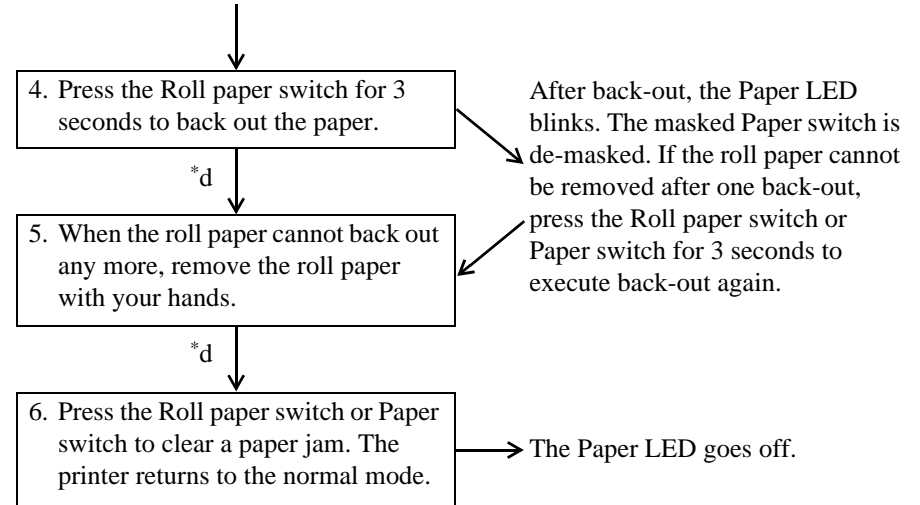
Specify the cutting position of the roll paper using the cutting position specifying command of the remote commands. When the specified position comes to the cutting position, the paper is cut automatically.

If the cutting position specifying command is not available for the roll paper, perform the "Panel operation in roll paper mode (Without cutter, tear-off line printing)" on Page 31.

Operating procedure



Continued from the left field

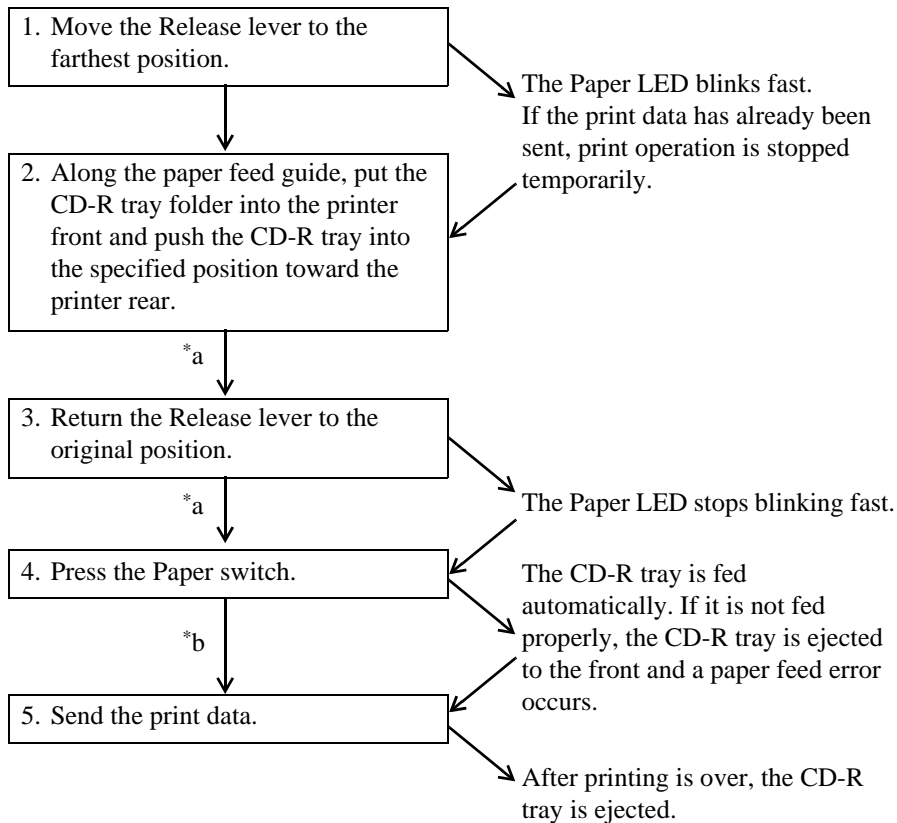


- *a : If power is switched off at this point, the panel feeding status is stored onto the EEPROM. When power is switched on again, the printer does not eject paper. The operation in Step 2. and later can be performed.
- *b : If power is switched off at this point, Tear Off is executed automatically to cut the roll paper, and the roll paper mode status is stored onto the EEPROM. When power is switched on again, the printer does not eject paper. The operation in Step 3. and later can be performed.
- *c : If power is switched off at this point, the roll paper mode status is stored onto the EEPROM. When power is switched on again, the printer does not eject paper. The operation in Step 3. and later can be performed.
- *d : If power is switched off at this point, the roll paper mode is canceled and the panel feeding cancel is stored. When power is switched on again next, the printer enters the normal mode if the Paper detection sensor is off.

1.3.9 Panel Operation for CD-R Printing

The following indicates the basic panel operating procedure for printing on CD-R.

Operating procedure



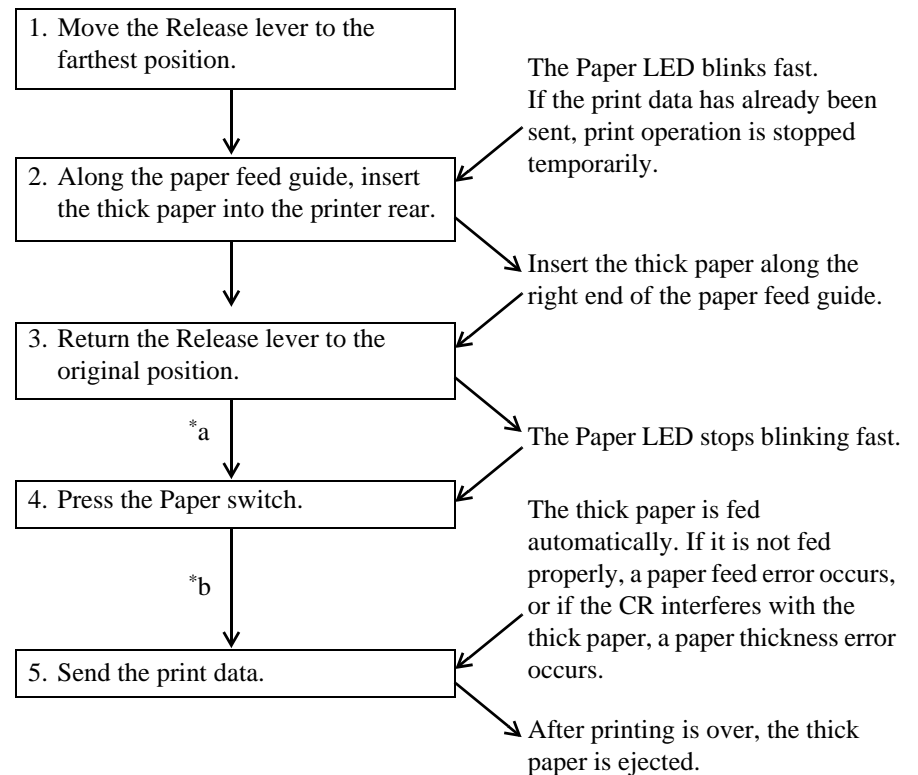
*a : If power is switched off and then on again at this point, the CD-R tray is not ejected and a paper jam error occurs. When you further press the Paper switch, the CD-R tray is ejected to the front and the printer returns to the normal mode.

*b : If power is switched off and then on again at this point, the CD-R tray is ejected to the front and the printer returns to the normal mode.

1.3.10 Panel Operation for Thick Paper Printing

The following indicates the basic panel operating procedure for printing on thick paper.

Operating procedure



*a : If power is switched off and then on again at this point, the thick paper is not ejected and a paper jam error occurs. When you further press the Paper switch, the thick paper is ejected and the printer then returns to the normal mode.

*b : If power is switched off and then on again at this point, the thick paper is ejected and the printer returns to the normal mode.

1.3.11 Panel Operation in Roller Cleaning Mode

If the ink concentration is increased within the printer driver detail setting, the ink printed on the medium may be transferred to the rollers. In this case, the ink may be transferred from the rollers to the print medium, making the print image dirty. If this phenomenon has occurred, start this mode to clean the rollers. If ink is transferred to the rollers heavily, start this mode and apply the cleaning pad packed with this product to the rubber rollers to clean the rollers.

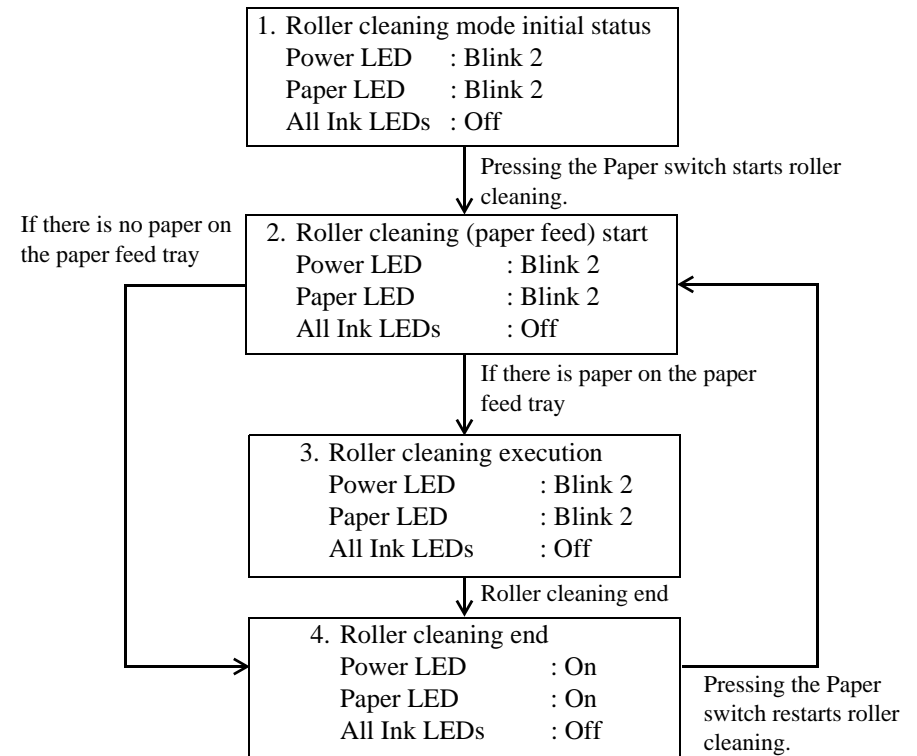
The following describes how to start and end the roller cleaning mode and operate the panel during the roller cleaning mode.

OPERATING PROCEDURE

□ Roller cleaning mode starting procedure

1. Initial status: Power off
2. Hold down the Ink switch and switch power on. → The Power LED is lit.
The Paper LED and all Ink LEDs blink 2.
3. Release the Ink switch. → The mechanism starts.
The Power LED blinks.
The Paper LED and all Ink LEDs go off.
↓
After the mechanism has ended starting, the roller cleaning mode starts.
(Roller cleaning mode initial status)
The Power LED blinks 2.
The Paper LED blinks 2 and all Ink LEDs go off.

□ Operating procedure in roller cleaning mode



NOTE: During the roller cleaning mode, the Ink switch and Roll paper switch are invalid.
During roller cleaning execution, the Paper switch, Ink switch and Roll paper switch are invalid.

□ End of roller cleaning mode

- When you press the Power switch during the roller cleaning mode, the roller cleaning mode ends and power switches off.
- When you press the Power switch during roller cleaning execution, the printer ejects the roller cleaning paper, and then the roller cleaning mode ends and power switches off.

1.3.12 Indicator Display in Normal Mode

Table 1-13. Printer Condition and LED Status

Printer status	Indicators			
	Power	Paper	Ink 1 - 7	priority
Power on condition	On	-	-	18
Data processing	Blink	-	-	17
Ink sequence	Blink	-	Special blink ^{*a}	16
Ink cartridge change mode	Blink	-	-	15
Ink level low	-	-	Blink ^{*b}	14
Paper out	-	On	-	13
Ink end	-	-	On ^{*b}	12
Ink color error	-	-	High speed blink ^{*b}	11
Ink combination error	-	-	High speed blink ^{*b}	10
No ink cartridge or Ink cartridge error	-	-	On ^{*b}	9
Double feed error	-	On	-	8
Paper jam condition	-	Blink	-	7
Paper gap error	-	On	-	6
Cutter jam error	-	Blink2	-	5
Release lever position error	-	High speed blink	-	4
Cutter position error	Off	Blink2	Blink2	3
Maintenance request	Off	Blink alternately 1	Blink alternately 2	2
Main board RAM Error	On	Slow blink	Slow blink	Slow blink
Fatal error	Off	High speed blink	High speed blink	1

^{*a} : Indicated by all Ink LEDs.

^{*b} : The Ink LEDs corresponding to the cartridge lines A, B, C, D, E, F, G turn on or blink individually. When viewed from the printer front, the places of inserting the ink cartridges are lines A, B, C, D, E, F, G from left to right and correspond to LED1, LED2, LED3, LED4, LED5, LED6, and LED7.

- "-" indicates no change.
- Blink : Repetition of On 0.5 sec + Off 0.5 sec
- Blink 2 : Repetition of On 0.2 sec + Off 0.2 sec + On 0.2 sec + Off 0.4 sec
- High speed blink : Repetition of On 0.1 sec + Off 0.1 sec
- Blink alternately 1 : Same as blink
- Blink alternately 2 : Repetition of Off 0.5 sec + On 0.5 sec
- Special blink : TBD

1.3.13 Error Status

If any of the following states is detected, this printer is put in an error status and turns the interface signal -ERROR "Low" and BUSY "High" to inhibit data input. At this time, the printer is automatically disabled from printing. However, when communication is being made using the IEEE1284.4 protocol, communication with the printer is enabled.

- Ink end
 - Ink end detection is performed for the monochrome and color inks.
 - When the ink is getting low, Ink Low is displayed. When the specified amount is consumed, the printer displays Ink End and stops. For the color cartridges, an Ink End error occurs if any one color ink ends.
- Paper Out
 - This error occurs if paper is not fed by paper feeding operation.
- Paper jam
 - When the residual paper cannot be ejected by the paper feeding operation of the specified step count at power-on or when paper cannot be ejected using the FF command or Paper feed/eject switch, it is regarded as a paper jam and an error occurs.
- No Ink cartridge or Ink cartridge error
 - The printer detected that any ink cartridge was not fitted or had come off.
 - The printer cannot read or write the CSIC information of any ink cartridge properly.
- Maintenance request
 - When the waste ink reaches the specified level, the printer displays this error and stops. The ink pad should be replaced by the service personnel, and this error should not be reset until the necessary area of the nonvolatile memory is rewritten.
- Fatal error
 - When detecting a fatal error such as a carriage control error, the printer is placed in an error status.
- Release lever position Error
 - This error occurs if the Release lever is in the release position.
 - This error occurs if the print mode is not adequate for the platen gap.
 - When this error occurs, the panel is made invalid and printing stops.
- Paper Gap Error
 - This error occurs if the printer judges that the gap between the head and paper is narrow when thick paper is fed.
 - When this error occurs, printing stops.
- Double feed error
 - This error occurs if two or more pieces of paper are fed and printed together or a paper feed displacement is detected in the double-sided printing mode.
 - When this error occurs, printing stops.
- Cutter Position Error
 - This error occurs if the printer detects that the cutter could not return to the home position after cutter operation or mechanism initialization.
- Cutter Jam Error
 - This error occurs if the printer detects that paper could not be cut properly after cutter operation.
- Ink Color Error
 - This error occurs if the printer detects that the new ink cartridge inserted during printing differs from the old one in color/type.
 - When this error occurs, printing stops.
- Ink Combination Error
 - This error occurs if the printer detects that the color/type combination of the ink cartridges inserted during ink replacement does not exist in the specifications.
 - When this error occurs, printing stops.

1.4 Casing Specifications

EXTERNAL DIMENSIONS

When tucked : 631 (width) × 320 (depth) × 205 mm (height)

When used : 631 (width) × 864 (depth) × 409 mm (height)

WEIGHT

11.7kg

EXTERNAL DIMENSION DIAGRAM

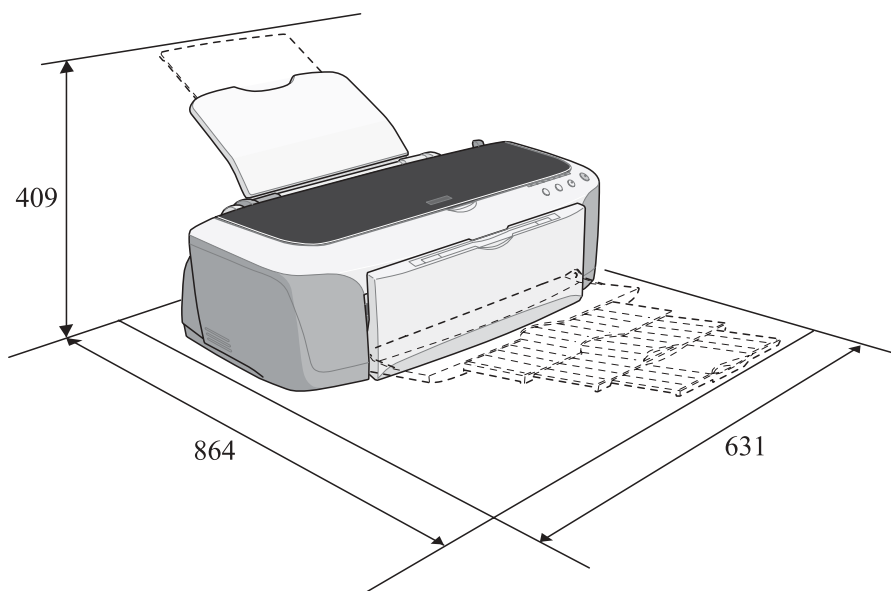


Figure 1-15. External Dimension Diagram

1.5 Accessories

STANDARD ACCESSORIES

- | | |
|--|---------|
| <input type="checkbox"/> Instruction manual | : 1 set |
| <input type="checkbox"/> Ink cartridge | : 1 set |
| <input type="checkbox"/> CD-ROM (Printer driver utility) | : 1 set |
| <input type="checkbox"/> Roll paper holder | : 1 set |
| <input type="checkbox"/> Sheet | : 1 pc. |
| <input type="checkbox"/> Customer information card | : 1 pc. |
| <input type="checkbox"/> Warranty: | : 1 pc. |
| <input type="checkbox"/> Free exclusive paper pack | : 1 set |
| <input type="checkbox"/> CD-R tray guide | : 1 pc. |
| <input type="checkbox"/> CD-R tray | : 1 pc. |
| <input type="checkbox"/> Cleaning kit | : 1 set |

CONSUMABLES AND OPTIONS

- | | |
|--|------------|
| <input type="checkbox"/> Ink cartridges | |
| Photo-black | : T0341 |
| Cyan | : T0342 |
| Magenta | : T0343 |
| Yellow | : T0344 |
| Light cyan | : T0345 |
| Light magenta | : T0346 |
| Light-black | : T0347 |
| Matte-black | : T0348 |
| <input type="checkbox"/> Roll paper auto cutter
(Cutter, paper support basket, instruction manual): PMA3NRAC1 | |
| <input type="checkbox"/> Ink cartridge storage box | : PMICBOX1 |
| <input type="checkbox"/> USB cable | : USBCB2 |

1.6 Environment Specification Items

Table 1-14. Environment Specification Items

	Class	Details	Results
Main unit	Resource usage reduction	Product Capacity	0.04m ³
		Product weight	11kg
	Energy saving	Total amount of power consumption	52.2Wh
		Turn-off power consumption	0.3W
		Compliance with the International Energy Star program	Compliant
	Recyclable design and use of recycled materials	Marking of materials to plastic parts	Indicated
		Percentage of parts using recycled material	20%
		Percentage of recyclable parts	85%
		Total number of parts	624parts
		Disassemblability of major units (Ease of disassembly)	110
		Disassembly index of parts (Ease of disassembly)	628
	Safety and environmental protection	Prohibition of the use of substances banned in EQS (EPSON Quality Standard) in the product	Confirmed
		Prohibition of the use of cadmium, lead, and mercury in batteries	Confirmed
		Prohibition of the use of ozone-depleting substances	Confirmed
		Reduction of release of harmful substances: for laser printers (Dust, Ozone, Styrene)	Dust:0.15mg/m ³ or less Ozone:0.02mg/m ³ or less Styrene:0.07mg/m ³ or less

Table 1-14. Environment Specification Items

	Class	Details	Results	
Main unit	Longevity	Expandability of memory :for laser printers	Implemented	
		Five-year guarantee of spare parts from the termination of production	Guaranteed	
	Others	Print capability on recycled paper	Able to print on recycled paper made from 100% waste paper	
		Operating noise : Sound Pressure level	43dB (A) or less	
Packaging and Packing Materials	Resource usage reduction	Capacity	0.16m ³	
		Weight	16kg	
	Recyclable design and use of recycled materials	Percentage of marking of materials to plastic parts	87%	
		Percentage of parts using recycled material	25%	
		Percentage of recyclable material by weight	75%	
		Percentage of material unification	85%	
		Percentage of recycled paper used	60%	
		Percentage of waste paper in recycled paper	50%	
	Safety and environmental protection	Use of non-bleached paper or paper bleached without chlorine	Confirmed (Using non-bleached paper)	
		Prohibition of the use of substances banned in EQS (EPSON Quality Standard) In the product	Confirmed	
		Total contents of heavy metals (lead, mercury, cadmium, sexivalent chromium)	100ppm or less	
	Consumables	Recyclable design and use of recycled materials	Marking of materials to plastic parts	Marking to all parts not less than 5g or more
		Safety and environmental protection	Prohibition of the use of substances banned in EQS (EPSON Quality Standard) In the product	Confirmed

CHAPTER

2

OPERATING PRINCIPLES

2.1 Overview

This chapter explains the operating principles of the mechanical sections and electrical circuits in this product. The main components of this product are as follows.

- Control circuit board : C387 MAIN
- Power supply circuit board : C387 PSB/PSE
- Control panel board : C387 PNL

2.2 Printer Mechanism

Like the Stylus PHOTO 2000P, this product uses DC motors as power sources. The following table describes the motor types and their applications.

Table 2-1. Various Motors

Motor Name	Type	Applications/Functions
CR motor	DC motor with brushes	Used for carriage driving. Makes little noise during driving. The CR linear scale and CR encoder sensor are used to control the motor.
PF motor	DC motor with brushes	Power source to drive the Paper loading rollers at the time of fixed-value paper loading or paper feed/eject operation. To grasp the paper feed pitch, the precision gear surface is fitted with the PF scale and the PF encoder sensor is used to control the motor.
ASF/Pump motor	4-phase, 48-pole PM type stepping motor	Drives the pump and performs paper feed operation from the ASF. Because of a stepping motor, this motor does not require a scale, photo sensor and like to be fitted to grasp the driving conditions.

Though the Stylus PHOTO 2100/2200 is similar in basic structure of the mechanism to the Stylus PHOTO 2000P, it has the following features.

- For compatibility with CD-R label direct printing, the CD-R tray adaptor and exclusive sensor are loaded. (Only for Stylus PHOTO 2100)
- To feed board paper and roll paper, the exclusive paper feed guide is fitted.
- For compatibility with the CD-R tray and correction of ink transfer to the roller, the newly designed paper eject unit is provided.

The following shows the outline of the printer mechanism.

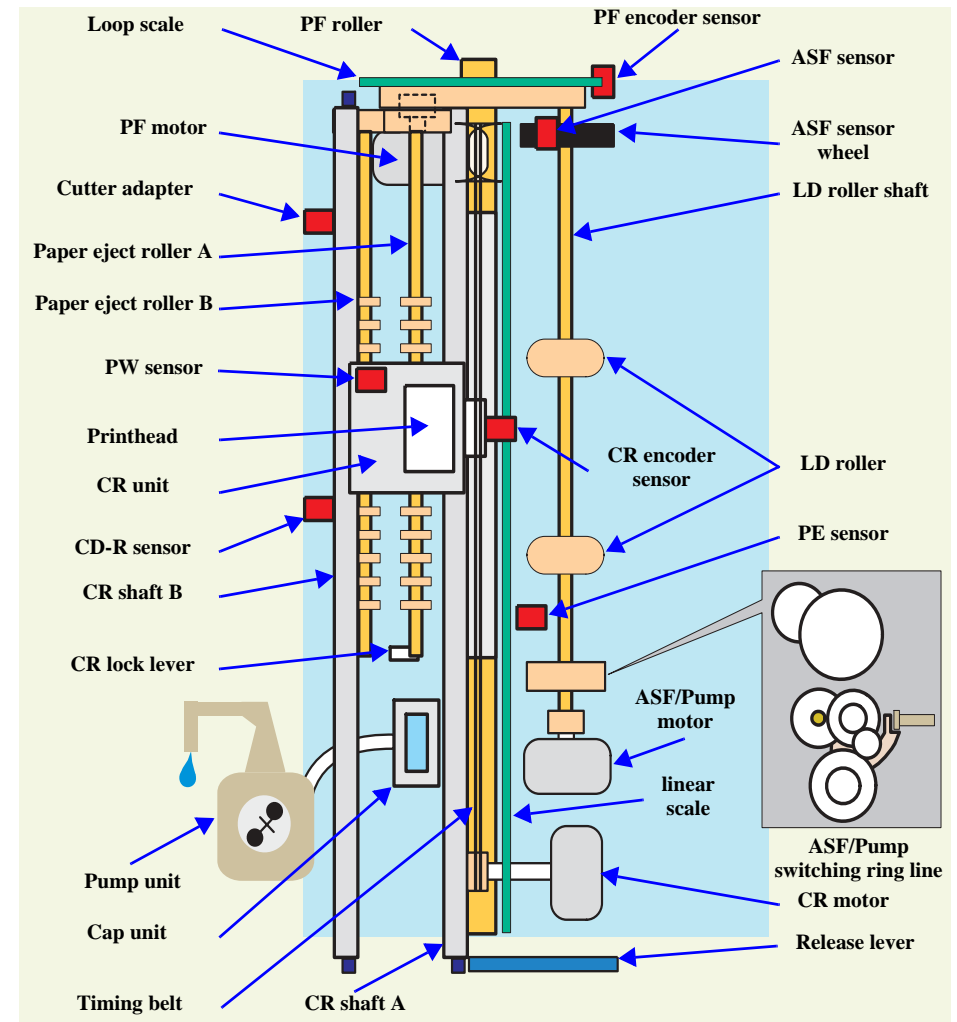


Figure 2-1. Printer Mechanism Outline

2.2.1 Carriage Mechanism

The Carriage mechanism consists of the Carriage motor (CR motor), Carriage guide shafts A (main shaft), B (sub shaft), Platen gap adjustment mechanism, Carriage lock mechanism, and others.

2.2.1.1 Carriage Motor (CR Motor)

Like the one of the conventional Stylus PHOTO 2000P, the Carriage mechanism of this product uses a DC motor as a drive source. The following indicates the Carriage driving DC motor specifications.

Table 2-2. CR Motor Specifications

Item	Specifications
Type	DC motor with brushes
Drive voltage	+42V +/- 5% (voltage applied to driver)
Winding resistance	23.0Ω +/- 15%
Inductance	24.0mH +/- 25%
Drive method	PWM, constant-current chopping
Drive IC	A3958

The CR motor of the conventional model uses a stepping motor, and the carriage unit position was controlled by open loop control. To stabilize the printing quality and ensure silent operation, however, this product adopts the DC motor and linear encoder-based closed loop control like the Stylus PHOTO 2000P to control the Carriage speed and position. Also, the conventional DAC control was changed to PWM control. Simultaneously, the basic signal (PTS signal) is generated to time ink discharge.

Driven by the CR motor, the Carriage unit moves within the printing area along the Carriage guide shaft of the printer mechanism during printing.

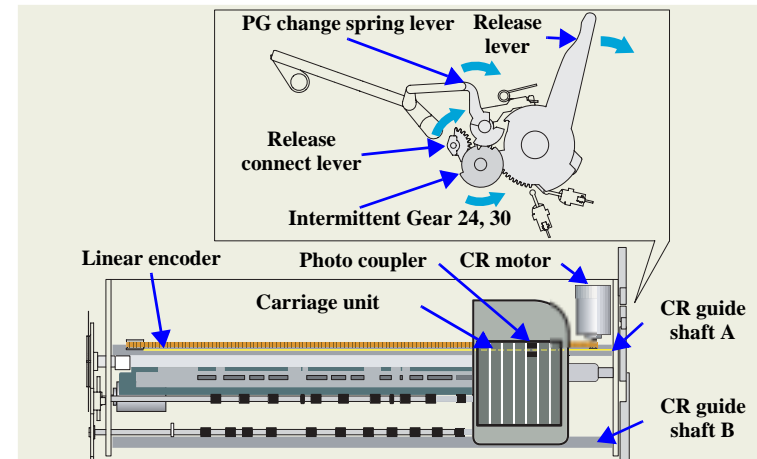


Figure 2-2. Carriage Mechanism

Using low-cost DC motors, this product grasps the variations of the torque constants, coil resistances and power supply board output voltages of the individual DC motors adequately to carry out heat generation control according to individual differences. The variations of the torque constant, coil resistance and power supply board output voltage of the motor are measured in a CR variation measurement sequence when the CR mechanical load is in the initial status (Max. 150g.cm) and saved into the EEPROM (AC<H>). According to the variations (individual differences) measured in this sequence, the voltage is corrected to make the drive current value constant (without an individual difference) according to the variations (individual differences) measured in this sequence.

Further, to set the appropriate drive current value according to the variation of the CR mechanical load, the mechanical load is measured in a CR measurement sequence and saved into the EEPROM 6C<H>, 6D<H> in a power-on or IC change sequence. However, if 14 is saved at the EEPROM 6C<H> and 05 at 6D<H>, Fatal error will occur since too large load is applied to the CR drive system.

Accordingly, not only the mechanical load but also the variations of the motor and like are taken into consideration to correct the drive current value of the CR motor. In addition, a heating value is calculated from the CR drive current value, and when the specified heating value is reached, wait time (0.3s to 7.9s) is provided per CR path for printing.

2.2.1.2 Carriage Home Position Detection

To detect the Carriage home position, the drive current of the CR motor and the speed/position signal of the CR linear encoder are used as in the conventional Stylus PHOTO 2000P.

The basic home position detection sequence is as described below.

1. The CR linear encoder pulse counter in the CPU is reset by the initialization operation performed at power-on.
2. When the CR motor rotates counterclockwise, the Carriage moves from left to right. When the following conditions are satisfied, the CPU assumes that the Carriage made contact with the right frame.
 - 2.1 When the ASIC detected 750/1500 counts or more in the PWM output under CR motor load positioning control, the temporary home position A is set as contact with the frame.
 - 2.2 P1 (number of output pulses from when power is switched on until the Carriage makes contact with the right frame) is 40 steps or less between reset 0 and A.
3. When the CR motor rotates clockwise, the Carriage moves from right to left. When the following conditions are satisfied, the CPU assumes that the Carriage made contact with the CR lock lever.
 - 3.1 When the ASIC detected 480/1500 counts or more in the PWM output under CR motor load positioning control, the printer judges that the Carriage made contact with the CR lock lever.
 - 3.2 A difference between P2 (number of output pulses from when the Carriage made contact with the right frame until it makes contact with the Carriage lock lever) and P1 is yy or less, and the number of outputs between A and CR lock lever is 40 steps or less.
4. When the CR motor rotates counterclockwise to move the Carriage from left to right and the CPU detects 750/1500 counts or more in the PWM output under CR motor load positioning control, the printer judges it as contact with the frame. At this time, the carriage position B is stored.
5. If a difference between P3 (number of output pulses from when the Carriage made contact with the Carriage lock lever until it makes contact with the right frame) and P1 has become Z or less, the printer judges that the Carriage is in the home

position. If a position difference between the temporary home position A and the second frame contact position B is 4 steps or less, the printer judges it as a home position.

Based on the output pulses (signals) from the CR linear encoder, the IC30 (ASIC) sets the drive current value adequate for the carriage motion (carriage moving direction and carriage position) of each operation and outputs it to the motor driver as a special control signal.

Based on the signal output from the IC30 (ASIC), the IC24 (CR motor driver) outputs the CR motor drive current to the CR motor.

2.2.1.3 Sequence Used for PW Detection

The PW detector on the Carriage unit bottom performs the following sequence.

Off-paper printing prevention control

Before start of printing (immediately after the end of paper locating) or during printing, whether paper is present or not is detected to prevent off-paper printing onto the Paper guide. (Applied to only the left or right end of the paper)
If the sent data has the paper size that is larger than the fed paper size, trimming is executed according to the paper size detected by the PW sensor, and frame printing is performed (frame width 2mm). Reversely, if the received data has the paper size that is smaller than the fed paper size, frame printing is also performed. This feature is designed to prevent off-paper printing onto the Paper guide by frameless printing performed in a wrong using method. However, in the fast mode for plain paper or postcards, paper width detection is not executed to improve the throughput. When the above using method is performed, the specifications of trimming and frame printing are not applied.

CD-R center detection control (Only for Stylus PHOTO 2100)

When printing is not being performed, the PW detector is used to detect the center of CD-R.

Refer to 2.2.3.6 "CD-R Printing Mechanism (Only for Stylus PHOTO 2100)" for details.

Board paper/roll paper leading edge detection control

Control exercised to detect the user-preset board paper leading edge, or control carried out to detect the roll paper edge. Therefore, the PW sensor does not detect a paper leading edge at the time of ASF cut sheet feeding.

Off-range restriction control

At the time of frameless printing, a paper leading edge is detected using the PW detector to restrict the frameless off-range amount.

■ Auto sheet feeder complete frameless mode

In the complete frameless mode, control is performed to print the print data 3mm larger at top, 5mm larger at bottom, and 2.5mm larger at left and right than the detected paper size.
(3mm larger at top, 5mm larger at bottom, and 3.5mm larger at left and right for A3 or A3+ size)

■ Roll paper mode

In the left and right frameless mode, control is performed to print the print data 2.5mm larger at left and right than the detected paper size.
(3mm larger at top, 5mm larger at bottom, and 2.5mm larger at left and right when the fixed-format mode is selected)

PW sensor dark voltage (VH) measurement

PW sensor dark voltage (VH) measurement is performed at the following timings and locations and used to calculate the threshold value of whether paper is present or not.

■ Cut sheets, Roll paper

The dark voltage is measured and updated at every power-on, and the threshold value (VS) is calculated and saved in the EPROM 76<H> area as a PW detection level. The dark voltage is measured at 3point on the left flat portion of the the Paper Guide Front. If the PW level measured in the Paper width measurement sequence is less than the PW detection level stored in the EEPROM, it means the sensor is detecting the paper.

■ CD-R tray (Only for Stylus PHOTO 2100)

When a CD-R is used, the dark voltage is measured on the CD-R tray, and the threshold value (VS) is then calculated and saved in the EPROM 76<H> area as a PW detection level.

If the PW sensor level measured in the CD-R HP detection sequence & CD-R center position detection sequence is less than the PW detection level stored in the EEPROM, it means the sensor is detecting the HP of the CD-R tray and the CD-R on the tray.

Every paper or CD-R tray is loaded, the voltage measured on the Paper or CD-R tray is stored in the EEPROM BB<H> area as a white level.

However, the white level value is not used in the PW sensor-related firmware processing. The white level value is used to check the sensor deterioration condition during servicing or like. If the measurement value of the white level is close to that of the PW detection level, it means that the sensor is dirty or deteriorated.

2.2.2 Print Mode

2.2.2.1 Printhead Specifications

The Printhead of this product is a G-Mach head.

The following shows the arrangement of the nozzles and the color arrangement of each nozzle line when they are viewed from behind.

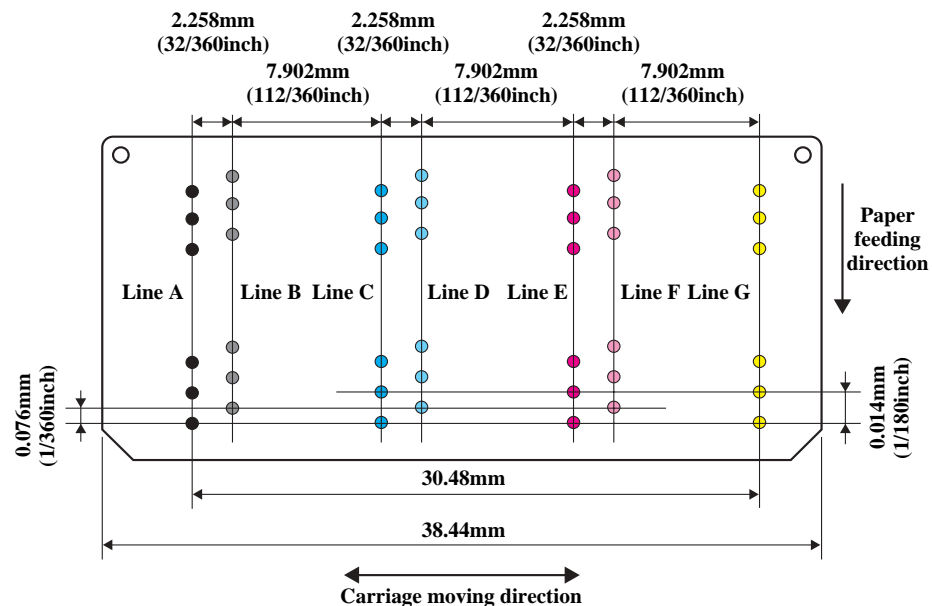


Figure 2-3. Nozzle Rear View

Table 2-3. Relationships between Nozzle Lines and Color Arrangement

Line	Ink
A	Photo-black or Matte-black
B	Light-black or Matte-black
C	Cyan
D	Light cyan
E	Magenta
F	Light magenta
G	Yellow

2.2.2.2 Ink Combinations and Corresponding Printing Resolutions and Printing Methods

The printing resolution and printing method are determined by setting the "Print medium" and "Printing quality" (can be set using the slide bar) on the printer driver according to Table 2-5 to Table 2-8 on the next pages. Table 2-5 to Table 2-8 on the next pages indicate detailed settings in the "Recommended setting" mode and "Manual setting".

Table 2-4. Dot Sizes

Dot Size	Combination	Drive Frequency	Printing Resolution	CR Speed
VSD1	13.8ng-27.6ng-41.5ng	8.64khz	360 × 360 720 × 360	240cps
VSD2	4.5ng-9.5ng-23.0ng	8.64khz	720 × 720 1440 × 720	240cps
VSD4	4.5ng × 2shot	6.84khz	2880 × 1440	190cps

The compatible medium also changes depending on the black ink combination set on the printer, as indicated in the tables on the next pages. The ink combination is reflected on the printer driver and "Paper type" on the driver UI is restricted to display only the usable media. This setting is also reflected on use of the photo quicker and the incompatible media are designed to be Light-blacked out.

**Table 2-5. Recommended Setting (Color & Black)
Photo-black + Light-black**

Print Medium	Slide Bar	Print Mode	Resolution	Bi-directional Printing	Microwave	Dot Size
Plain Paper	Speed /Fast	Normal-360 /Fine	360×360	ON	ON	Variable 1
	Quality /Fine	Photo-720 /Photo	720×720	ON	ON	Variable 2
Photo Quality Ink Jet Paper 2	Speed /Fast	Fine-360/ Superfine	720×360	ON	ON	Variable 1
	Quality /Fine	Photo-720 /Photo	720×720	ON	ON	Variable 2
Archival Matte Paper	Speed /Fast	Photo-720 /Photo	720×720	ON	ON	Variable 2
	Quality /Fine	Photo-1440 /Photo (Super)	1440×720	ON	Super	Variable 2
Premium Glossy Paper-Photo	Quality /Fine	Photo-1440 /Photo (Super)	1440×720	ON	Super	Variable 2
	High Quality /Precision	Photo-2880 /Super photo	2880×1440	ON	ON	Variable 4
Glossy Paper-Photo Weight	Quality /Fine	Photo-1440 /Photo (Super)	1440×720	ON	Super	Variable 2
	High Quality /Precision	Photo-2880 /Super photo	2880×1440	ON	ON	Variable 4
Watercolor Paper-Radiant White	Speed /Fast	Photo-720 /Photo	720×720	ON	ON	Variable 2
	Quality /Fine	Photo-1440 /Photo (Super)	1440×720	ON	Super	Variable 2
CD-R label (Only for Stylus PHOTO 2100)	-	Photo (Super)	1440×720	OFF	Super	Variable 2
	-	Photo-1440 /Photo (Super)			ON	

Note: Boldface : Preset mode

Table 2-6. Manual Setting (Color & Black) Photo-black + Light-black

Print Medium	Print Mode	Resolution	Bi-directional Printing	Microwave	Dot Size
Plain Paper	Draft /Draft *1	360×360	ON	OFF	Variable 1
	Normal-360 /Fine	360×360	ON/OFF	ON (95)	Variable 1
	Photo-720 /Photo	720×720	ON/OFF	ON (47)	Variable 2
Photo Quality Ink Jet Paper 2	Fine-360/ Superfine	720×360	ON/OFF	ON (39)	Variable 1
	Photo-720 /Photo	720×720	ON/OFF	ON (45)	Variable 2
	Photo-1440 /Photo (Super)	1440×720	ON/OFF	ON/Super (23)	Variable 2
Archival Matte Paper	Photo-720 /Photo	720×720	ON/OFF	ON (45)	Variable 2
	Photo-1440 /Photo (Super)	1440×720	ON/OFF	ON/Super (23)	Variable 2
Premium Glossy Paper-Photo	Photo-1440 /Photo (Super)	1440×720	ON/OFF	ON/Super (23)	Variable 2
	Photo-2880 /Super photo	2880×1440	ON/OFF	ON/Super (23)	Variable 4
Glossy Paper-Photo Weight	Photo-1440 /Photo (Super)	1440×720	ON/OFF	ON/Super (23)	Variable 2
	Photo-2880 /Super photo	2880×1440	ON/OFF	ON/Super (23)	Variable 4
Watercolor Paper-Radiant White	Photo-720 /Photo	720×720	ON/OFF	ON (45)	Variable 2
	Photo-1440 /Photo (Super)	1440×720	ON/OFF	ON/Super (23)	Variable 2
CD-R label (Only for Stylus PHOTO 2100)	Photo (Super)	1440×720	OFF	Super	Variable 2

Note: Boldface : Preset mode

*1 : Medium and printing mode where frameless printing cannot be performed (that do not have compatible microwave)

- Plain paper/Economy

Table 2-7. Recommended Setting (Color & Black) Matte-black + Light-black

Print Medium	Slide Bar	Print Mode	Resolution	Bi-directional Printing	Microwave	Dot Size
Plain Paper	Speed /Fast	Normal-360 /Fine	360×360	ON	ON	Variable 1
	Quality /Fine	Photo-720 /Photo	720×720	ON	ON	Variable 2
Photo Quality Ink Jet Paper 2	Speed /Fast	Fine-360/ Superfine	720×360	ON	ON	Variable 1
	Quality /Fine	Photo-720 /Photo	720×720	ON	ON	Variable 2
Archival Matte Paper	Speed /Fast	Photo-720 /Photo	720×720	ON	ON	Variable 2
	Quality /Fine	Photo-1440 /Photo (Super)	1440×720	ON	ON	Variable 2
		Photo-2880 /Super photo	2880×1440			Variable 4
Watercolor Paper-Radiant White	Speed /Fast	Photo-720 /Photo	720×720	ON	ON	Variable 2
	Quality /Fine	Photo-1440 /Photo (Super)	1440×720	ON	ON	Variable 2
		Photo-2880 /Super photo	2880×1440			Variable 4
CD-R label (Only for stylus PHOTO 2100)	-	Photo	1440×720	OFF	Super	Variable 2
	Photo-1440 /Photo (Super)	ON				

Note: Boldface : Preset mode

Table 2-8. Manual Setting (Color & Black) Matte-black + Light-black

Print Medium	Print Mode	Resolution	Bi-directional Printing	Microwave	Dot Size
Plain Paper	Draft /Draft*2	360×360	ON	OFF	Variable 1
	Normal-360 /Fine	360×360	ON/OFF	ON (95)	Variable 1
	Photo-720 /Photo	720×720	ON/OFF	ON (47)	Variable 2
Photo Quality Ink Jet Paper 2	Fine-360/ Superfine	720×360	ON/OFF	ON (39)	Variable 1
	Photo-720 /Photo	720×720	ON/OFF	ON (45)	Variable 2
	Photo-1440 /Photo (Super)	1440×720	ON/OFF	ON/Super (23)	Variable 2
Archival Matte Paper	Photo-720 /Photo	720×720	ON/OFF	ON (45)	Variable 2
	Photo-1440 /Photo (Super)	1440×720	ON/OFF	ON/Super (23)	Variable 2
	Photo-2880 /Super photo	2880×1440	ON/OFF	ON/Super (23)	Variable 4
Watercolor Paper- Radiant White	Photo-720 /Photo	720×720	ON/OFF	ON (45)	Variable 2
	Photo-1440 /Photo (Super)	1440×720	ON/OFF	ON/Super (23)	Variable 2
	Photo-2880 /Super photo	2880×1440	ON/OFF	ON/Super (23)	Variable 4
CD-R label (Only for stylus PHOTO 2100)	Photo (Super)	1440×720	OFF	Super (23)	Variable 2

Note: Boldface : Preset mode

*2 : Medium and printing mode where frameless printing cannot be performed (that do not have compatible microwave)

- Plain paper/Economy

2.2.2.3 Head Hot Error

If Head Hot occurred due to either of the following factors on the conventional printer, the Ink End value was written to the Ink consumption counter and Ink End error was displayed. This product displays Fatal error.

□ Head Hot error factors

1. If more than half of all nozzles are clogged and cannot discharge ink, ink will not flow through the path, resulting in a Head Hot status.
2. If a multi-nozzle dropout attributable to a vertical fall or like occurs in more than half of all nozzles, ink will not flow through the path, resulting in a Head Hot status.

□ Reason why Fatal error is displayed

If either of the above factors occurs, the conventional model that did not adopt the CSIC displayed Ink End error at occurrence of Head Hot. Reason: A wrong Ink End value was written to the Ink consumption counter by the ink cartridge removing/inserting operations performed before the Ink End error. Because of this, the Ink End error was adopted to prevent Head Hot that would be caused by continuous off-paper printing since the printer could not recognize an Ink End status if the Ink cartridge is in that status.

On the model that adopts the CSIC, it is inconceivable that a wrong Ink End value is written to the Ink consumption counter, and Head Hot occurs only due to the above factors. However, when the nozzles are clogged, the chances that the user can restore it to normal are extremely remote, because if the user whose printer resulted in Head Hot installs a new Ink cartridge, the Ink End value is written to the Ink cartridge, and therefore, the printer will result in a Head Hot status again. As a result, the Ink cartridge has no problem but that Ink cartridge becomes unusable. To avoid this, the hardest CL is executed automatically to return from a multi-nozzle dropout in order to provide protection from the factor 2 at occurrence of the Head Hot error. If the Head Hot error still persists, Fatal error is displayed to prompt the user to send the printer to the repair center.

2.2.2.4 Pseudo Four-color Mode

This print mode can be selected in the detail setting mode when the plain paper is selected, and means the draft mode.

In this mode, the printer operates as a pseudo four-color printer, with Lines A and B used for one color of BK, Lines C and D for one color of C, Lines E and F for one color of M, and Line G for one color of Y.

Therefore, since two lines of head nozzles are used as one color for each of BK, C and M, 192 nozzles are used for each color and the printing resolution is 360 x 360dpi. For Y, the resolution is 360 x 180dpi and 96 nozzles are used.

The JFK of the driver creates the four-color 360 x 360dpi mode and sends it to the printer. For Y, however, the dot structures of the top and bottom lines are ORed to print on one line.

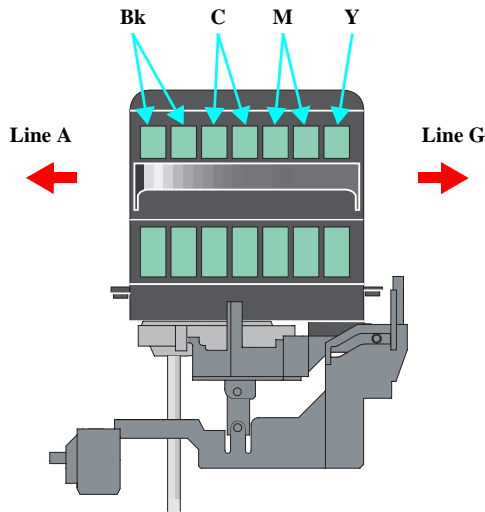


Figure 2-4. Pseudo Four-color Mode

2.2.3 Paper Feeding Mechanism

The paper feeding mechanism indicates the mechanism that feeds paper or CD-R to the PF roller shaft.

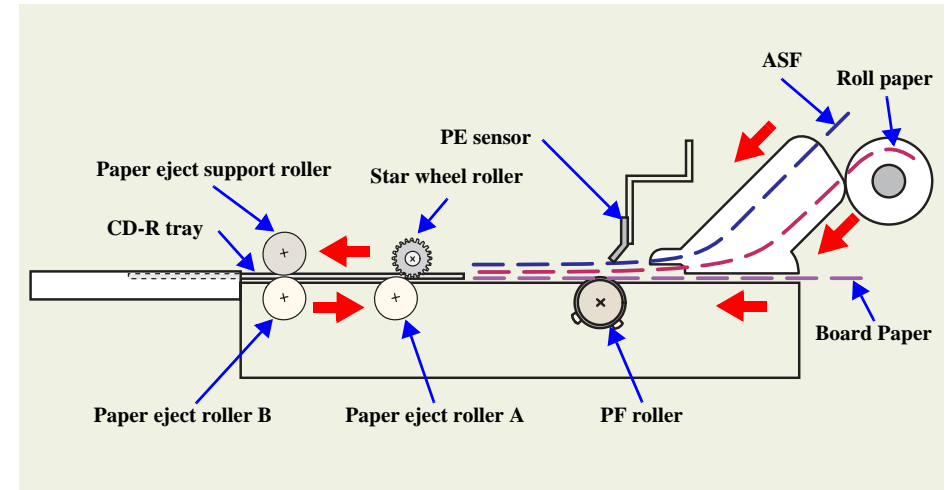


Figure 2-5. Paper Feeding Mechanism

2.2.3.1 ASF Paper Feeding Mechanism

Table 2-9. ASF/Pump Motor Specifications

Item	Specifications
Type	4-phase, 48-pole PM type stepping motor
Drive method	Bipolar drive/constant-current drive
Drive voltage	+42V +/- 5% (voltage applied to driver)
Winding resistance	7.0Ω +/- 10% (per phase at 25°C)
Inductance	10.0mH +/- 20% (1kHz 1Vrms)

The following table indicates the rotation directions for driving the ASF unit/pump mechanism.

Table 2-10. ASF/Pump Motor Rotation Directions

Rotation Direction	D/E	ASF Paper Feed Roller Operation	Pump Operation
CW ^{*a}	Pump switching direction	Paper return lever setting	Pump suction/wiper setting
CCW ^{*b}	ASF switching direction	Paper feed	Pump releasing Wiper resetting

*a: CW (CW is defined as the clockwise direction as viewed from the ASF/Pump motor pinion)

*b: CCW (CCW is defined as the counterclockwise direction as viewed from the ASF/Pump motor pinion)

The driving force of the ASF/Pump motor is transmitted to the ASF unit by the Carriage unit operation and DE mechanism switching operation described in the following section.

2.2.3.2 Drive Transmission Path to ASF Unit

1. The Carriage unit moves to the right end of the Carriage guide shaft to move the DE lock lever to the right end.
2. The ASF/Pump motor rotates in the CCW direction (as viewed from the motor pinion gear side) by the specified number of steps.
3. As the ASF/Pump motor rotates in the CCW direction, the Planetary lever unit in the DE mechanism moves toward the combination gear 12, 22.4.
4. As the Carriage unit moves leftward from the right end of the Carriage guide shaft by the specified number of steps, the DE lock lever fixes the Planetary lever unit.
5. The driving force of the ASF/Pump motor is transmitted in the following path. Motor pinion gear → Planetary lever unit → Combination gear 12, 22.4 → Combination gear 14, 28 → Spur gear 32 (ASF side)

The following shows the part names and operation outline of the DE mechanism.

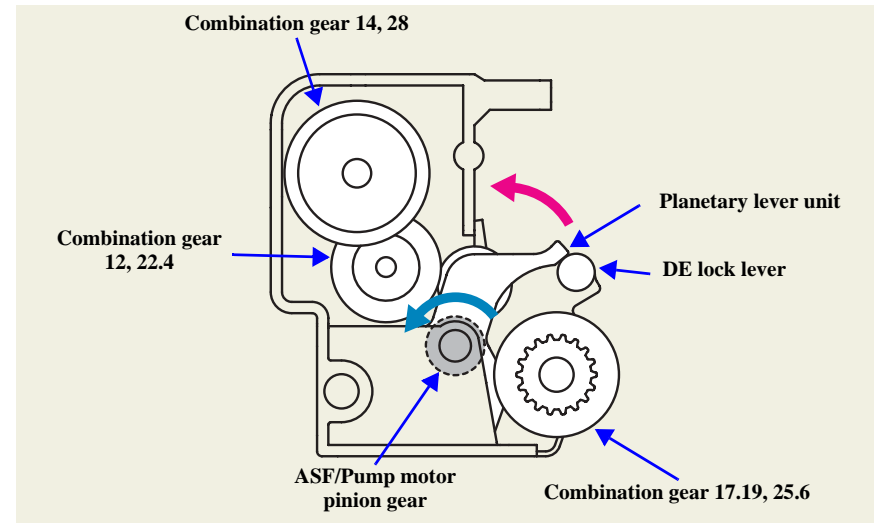


Figure 2-6. DE Mechanism

2.2.3.3 ASF Paper Feeding Operation

Using the driving force transmitted from the ASF/Pump motor via the DE mechanism, the ASF unit performs the following paper feeding operation.

To achieve stable paper feeding operation of the paper feeding mechanism of this product, the double-feed prevention mechanism is installed in the ASF. To prevent paper from dropping into the paper path from the paper setting position in the ASF unit, the Paper return lever returns the paper to within the ASF hopper securely, and the LD roller then starts paper feeding operation. Refer to the following steps for details of the paper feeding operation including that of the double-feed prevention mechanism.

1. At power-on, the ASF/Pump motor rotates in the CCW direction and the ASF home position is detected. Then, the ASF/Pump motor rotates in the CW direction by the specified number of steps, thereby setting the LD roller and Paper return lever in the paper feeding standby position. Refer to [Standby status] in Figure 2-7, "Paper Feeding Operation".
2. When you give a paper feeding command from the PC and press the Paper switch on the panel, the ASF/Pump motor rotates in the CCW direction and the LD roller starts paper feeding. Refer to [Paper feeding status] in Figure 2-7, "Paper Feeding Operation".
3. When the paper is transferred from the ASF unit to the PF roller and detected by the PE sensor, the LD roller stops in the position where the friction of the LD roller is cleared. Refer to [PF roller passing status] in Figure 2-7, "Paper Feeding Operation".
4. Then when you give a print command and press the Paper switch on the panel, the ASF/Pump motor rotates in the CW direction by the specified number of steps, thereby setting the LD roller and Paper return lever in the paper feeding standby position. Refer to [Standby status] in Figure 2-7, "Paper Feeding Operation".

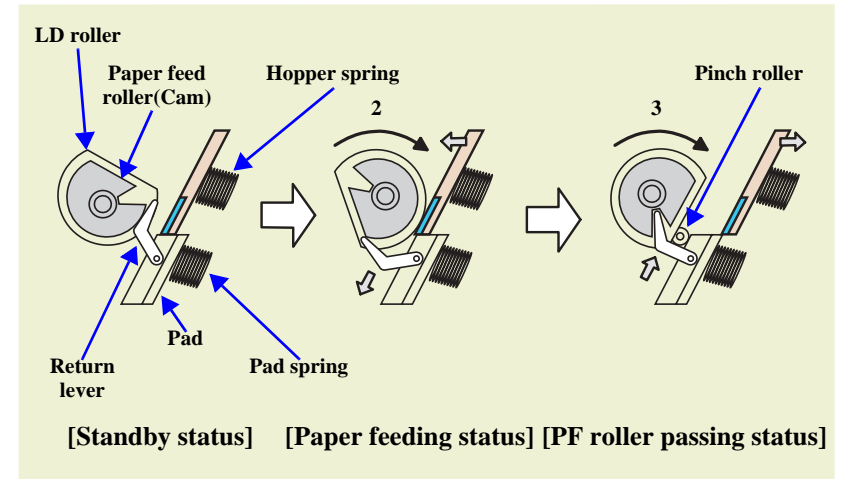


Figure 2-7. Paper Feeding Operation

2.2.3.4 Manual Paper Feeding Mechanism (Board Paper)

To enable direct printing onto thick paper and CD-R label, this product has the mechanism to feed paper from the printer front and rear manually.

Move the Release lever to the farthest position, insert thick paper from the rear manual feed slot until its leading edge reaches a position about 1cm from the PF/Driven roller, and set the Release lever in the thick paper mode.

When the PE sensor detects the paper after the above Release lever has been operated, pressing the Paper feed switch causes the PW sensor to detect the leading edge of the paper and the printer to perform paper locating control and enter the standby status.

2.2.3.5 Roll Paper Feeding

Since panel operation in the roll paper mode differs from the above operation, the differences of panel operation after roll paper feeding will be described.

1. When roll paper is fed with the Release lever not in the release position, the PE sensor detects the paper, and after 2 seconds has elapsed, the paper is fed.
2. The PW sensor check for the leading edge of the paper, and if it detects the paper, the printer operates in the cutter self-cleaning mode.
3. The printer back-feeds the paper to the paper print starting position.

As explained above, when roll paper is inserted from the Roll paper feeding guide to the paper feeding position of the PE sensor, paper is automatically fed and back-fed to the print starting position. At this time, panel switch operation is invalid (since 02<H> is written to 3F<H> in the EEPROM), and the definitions of the panel operation and Paper feed switch differ between cut sheets and roll paper.

When roll paper is fed, 02<H> is written to the EEPROM 3F<H> area, but when roll paper print data is received from the PC, 01<H> is written to the 3F<H> area. Panel switch operation differs as described below between when 02<H> is written to the 3F<H> area and when 01<H> is written there.

- When 02<H> is written

Pressing the Roll paper cut switch for more than 3 seconds back-feeds the leading edge of the roll paper to the PE sensor (the Paper LED blinks). When the roll paper is removed from under the PE sensor in this state, paper is fed from the ASF.

- When 01<H> is written and cutter is fitted

When the data from the photo quicker is "No auto cut", pressing the Roll paper cut switch after end of printing feeds the separation position in the print data to the roll paper cut position and returns the leading edge of the paper to the print starting position after paper cutting.

When the data from the photo quicker is "Standard 1 cut" or "Specific 2 cuts", the roll paper is cut automatically at every separation of the print data, and the leading edge of the paper is then returned to the print starting position.

- When 01<H> is written and cutter is not fitted

Pressing the Roll paper cut switch after end of printing prints a tear-off line and feeds the roll paper to the roll paper cut position. When you cut the roll paper with scissors or like and then press the Roll paper switch again, the paper returns to the print starting position.

The auto cut setting section of the print option in the photo quicker is displayed according to the Auto cutter fitting radio button setting in the printer information within the driver.

2.2.3.6 CD-R Printing Mechanism (Only for Stylus PHOTO 2100)

□ CD-R tray home position detection sequence

When the CD-R attachment is fitted, the Release lever setting position (PG sensor: Close, Release sensor: Open) and CD-R tray sensor (Close) are detected. By pushing the CD-R tray into the specified position and pressing the Paper feed switch in this status, the following operation is performed.

1. The Carriage unit moves to the CD-R tray home position detection position (white label position).
2. The CD-R tray is pulled in the ASF direction.
3. When the PW sensor of the Carriage unit detects the CD-R home position, the Carriage unit moves to the CD-R tray center position (horizontal center of the CD).
4. The CD-R tray is fed in the paper ejection direction and the trailing edge of the CD-R is detected. Then, the CD-R tray is fed in the ASF direction again and the leading edge of the CD-R is detected. After that, the CD-R tray is fed to the CD-R tray center position in the paper ejection direction.
5. In the position in Step 4, the Carriage unit moves rightward and the detection of the CD-R horizontal direction starts. After the left end of the CD-R is detected, the Carriage unit moves rightward again and the CD-R horizontal direction is detected.
6. The Carriage unit stops at the CD-R tray home position detection position (paper feeding direction) and the CD-R tray is fed in the paper ejection direction. When the home position is detected, both the Carriage unit and CD-R tray stop operating and are put in a standby status.

If the CD-R tray home position or CD-R cannot be detected in the specified step operation of each step in the above sequence, the CD-R tray is ejected and Paper out error is displayed. If the Release lever setting position (PG sensor: Close, Release sensor: Open) and CD-R tray sensor (Close) are detected when the CD-R attachment is fitted, pressing the Paper feed switch will not start paper feed from the ASF. In this case, pressing the Paper feed switch performs the CD-R tray home position detection sequence.

When the CD-R tray is detected, Release lever error is displayed if the Release lever setting position is other than the CD-R position.

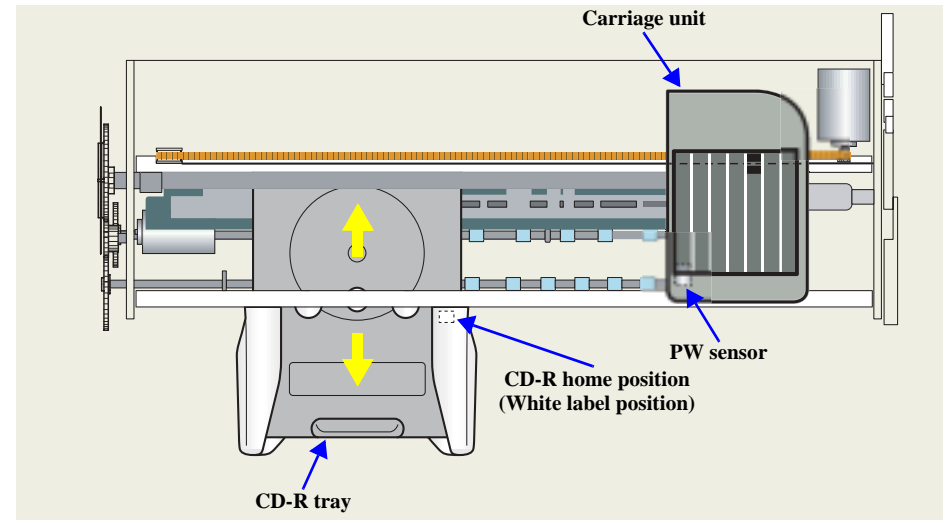


Figure 2-8. CD-R Mechanism

2.2.4 Paper Loading Mechanism

The Paper loading mechanism is designed to transfer the paper fed from the ASF, Roll paper guide or Board paper guide or the CD-R fed from the CD-R tray according to the print data.

2.2.4.1 Paper Loading Mechanism

The Paper loading mechanism consists of the PF roller and Paper eject rollers to transfer paper. The Paper feeding (PF) motor is a DC motor. The following table indicates the PF motor specifications.

Table 2-11. PF Motor Specifications

Item	Specifications
Type	DC motor with brushes
Drive voltage	+42V +/- 5% (voltage applied to driver)
Winding resistance	23.0Ω +/- 25%
Inductance	24.0m +/- 25%
Drive method	PWM
Drive IC	A3958

Like the Stylus PHOTO 2000P, this product uses closed loop control by means of the DC motor and rotary encoder to improve paper loading accuracy. The rotary encoder is installed on the left end of the roller shaft to control the paper loading amount. The driving force of the PF motor is transmitted to the PF roller and Paper eject rollers in the following paths.

PF roller drive transmission path

PF motor/pinion gear → Spur gear 76 → PF roller shaft

Paper eject roller drive transmission path

PF motor/pinion gear → Spur gear 76 → Combination gear 17, 24.5 → Spur gear 62 → Spur gear 43 → Paper eject roller shaft A

The following shows the part names and outline of the PF roller driving force transmission path. With the driving force transmitted in above paths, paper is transferred in the following path.

PF motor/pinion gear → Spur gear 76 → Combination gear 17, 24.5 → Spur gear 62 → Paper eject roller shaft B

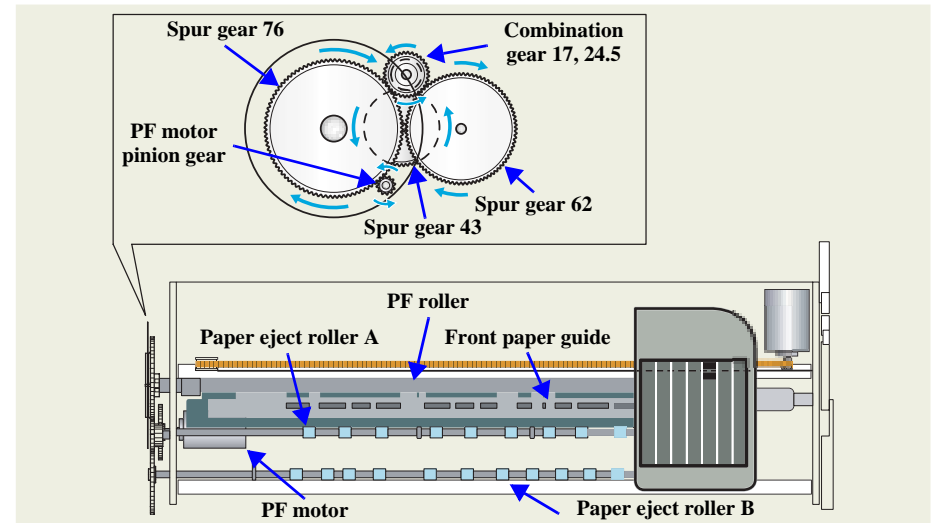


Figure 2-9. Paper Loading Mechanism 1

The paper fed from the ASF, Roll paper guide or Board paper guide is detected by the PE sensor installed on the right side of the Upper frame, and its leading edge is transferred to the center front of the Paper guide once.

To eliminate the deflection of the paper, the paper is then returned toward the ASF unit by the specified number of steps according to the paper feed mode, and is transferred again to the specified paper locating position toward the front of the Paper guide.

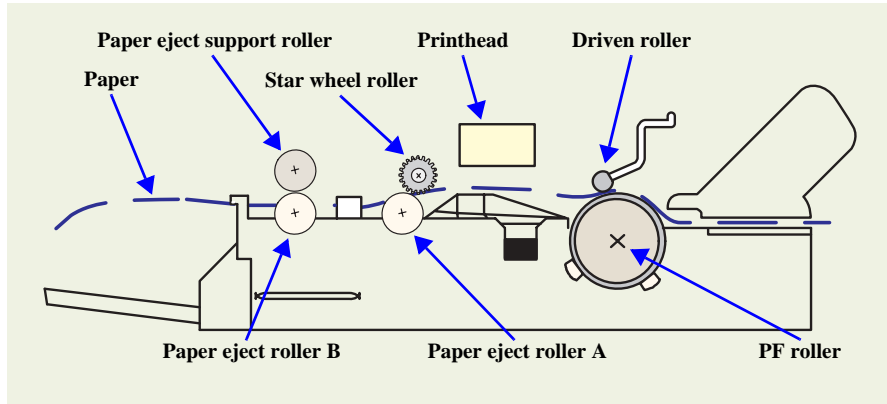


Figure 2-10. Paper Loading Mechanism 2

2.2.4.2 Paper Eject Mechanism

As compared to the Stylus PHOTO 2000P, the spring load of the Knurled rollers above the Paper eject roller (Paper guide front side) is about 1/4 lower to reduce the traces of the Knurled rollers. Therefore, the main purpose of installing these Knurled rollers is not paper transfer but its main function is to hold down transferred paper during printing.

As compared to the Stylus PHOTO 2000P, the rubber roller on the paper eject side (Paper eject roller) has the following features to fully dry ink that may be transferred to the Paper eject roller.

- Roller diameter : About twice larger
- Position : Placed about three times longer distance away
- Width : About three times larger
- Material : Rubber based

2.2.4.3 Paper Mode Setting

The paper mode that matches the print medium is selected according to the statuses of the PE sensor, CD-R sensor (Only for Stylus PHOTO 2100) and Release lever (sensor) to determine the paper loading sequence (paper locating control). The following table indicates the relationships between the sensors and paper modes.

Table 2-12. Paper Mode Setting

Paper Mode	PE Sensor	CD-R Sensor	PG Sensor	Release Sensor
Roll paper	ON	OFF	ON	OFF
Board paper	ON	OFF	OFF	OFF
CD-R (Only for Stylus PHOTO 2100)	OFF	ON	OFF	ON

Note: Panel switch operations change depending on the selected paper mode.
When the PE sensor detects paper after operation of the Release lever, pressing the Paper feed switch causes the PW sensor to detect the leading edge of the paper and the printer to perform paper locating control and enter the standby status.

□ Wait time

Photo-ink (HCD ink: Photo-black, Light-black) is easy to dry, but Matte-ink (PPI ink: Matte-black) is difficult to dry. For the medium that uses Matte-black, therefore, paper is transferred after a maximum of 2 second wait time has elapsed after printing according to paper loading amount conditions.

■ Waiting conditions

1. When the paper loading instruction is 2672/1440 steps or more, paper loading starts after the wait time.
2. When the paper loading amount is less than 2672/1440 steps, the time taken between paper loading and printing up to the roller is estimated so that the time to reach the roller will be the wait time.

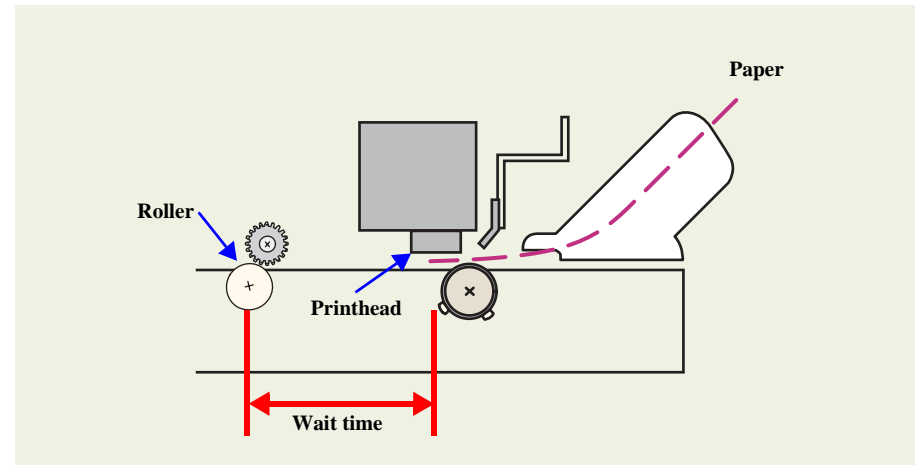


Figure 2-11. Wait Time

2.2.4.4 PG Detection (Release Lever)

The following gives the relationships between the Release lever, PG sensor and Release sensor.

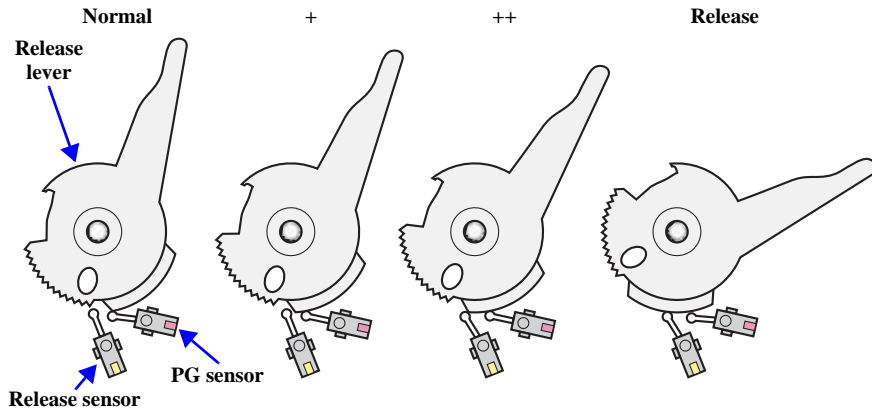


Figure 2-12. Release Lever and PG Sensor Positions

Table 2-13. Detection Modes of PG Sensor

Release Lever	PG Sensor	Release Sensor	Setting Mode
Normal	ON	OFF	Cut sheet, Roll paper
+	OFF	OFF	Board paper
++	OFF	ON	CD-R (Only for Stylus PHOTO 2100)
Release	ON	ON	-

Note: When the PG position is the + position (PG sensor: OFF, Release sensor: OFF, Setting mode: Board paper, Thick paper), the printing method is forcibly changed to Uni-D.

2.2.4.5 PF Measurement Sequence

- The mechanical load in the paper loading path is measured at every power-on and I/C replacement/exchange sequence to perform control so that an adequate current value is set according to the mechanical load.
- When the mechanical load in the paper loading path reaches the specified value (B9<H> or BA<H> address = 79<H>), Fatal error is displayed. (When the cutter is not fitted)
- When the cutter is fitted, the mechanical load when the cutter is fitted is measured and reflected on the control since the mechanical load of the cutter must be taken into consideration to set the adequate current value. (If B9<H> + 6A<H> address or BA<H>+6B<H> address= 79<H>, Fatal error occurs.)

2.2.5 Ink System Mechanism

The Ink system mechanism consists of the Pump unit (including the Carriage lock lever) and Capping mechanism. The Cap unit is in close contact with the CR unit and drains ink from the Ink cartridge to Head cavities to Cap to Waste ink pad using the driving force of the Pump unit.

2.2.5.1 Pump Mechanism

The Pump mechanism is designed to suck ink from the Printhead or Cap assembly. The Cap assembly has a built-in head cleaning wiper. The following gives the operation outline of the Pump mechanism.

To provide the driving force of the Pump mechanism, a 4-phase, 48-pole PM type stepping motor is used as the ASF/Pump motor. For the specifications of the ASF/Pump motor, refer to 2.2.3.1 Table 2-9 "ASF/Pump Motor Specifications". When the driving force of the ASF/Pump motor is switched to the Pump unit side by the DE mechanism, the functions of the Pump mechanism are as indicated in the following table depending on the rotation direction of the ASF/Pump motor.

Table 2-14. ASF/Pump Motor Rotation Directions and Functions

ASF/Pump Motor Rotation Direction ^{*a}	Functions
CW direction	Pump suction Wiper setting
CCW direction	Pump release Wiper resetting

*a: Pump rotation direction (Clockwise direction as viewed from the pump drive input gear is defined as forward rotation)

The next section gives the path in which the driving force of the ASF/Pump motor is transmitted to the Pump mechanism.

2.2.5.2 Drive Transmission Path to Pump Unit

1. The Carriage unit moves to the right end of the Carriage guide shaft to move the DE lock lever to the right end.
2. The ASF/Pump motor rotates in the CW direction (as viewed from the motor pinion side) by the specified number of steps.
3. As the ASF/Pump motor rotates in the CW direction by the specified number of steps, the Planetary lever unit in the DE unit moves toward the Combination gear 17.19, 25.6.
4. As the CR unit moves leftward from the right end of the Carriage guide shaft by the specified number of steps, the DE lock lever fixes the Planetary lever unit in position.
5. The driving force of the ASF/Pump motor is transmitted in the following path. Motor pinion gear → Planetary lever unit → Combination gear 17.19, 25.6 → Tension belt → Combination gear 12, 29.92 → Spur gear 26.4 → Pump unit gear → Pump unit

The following shows the part names and operation outline of the DE mechanism.

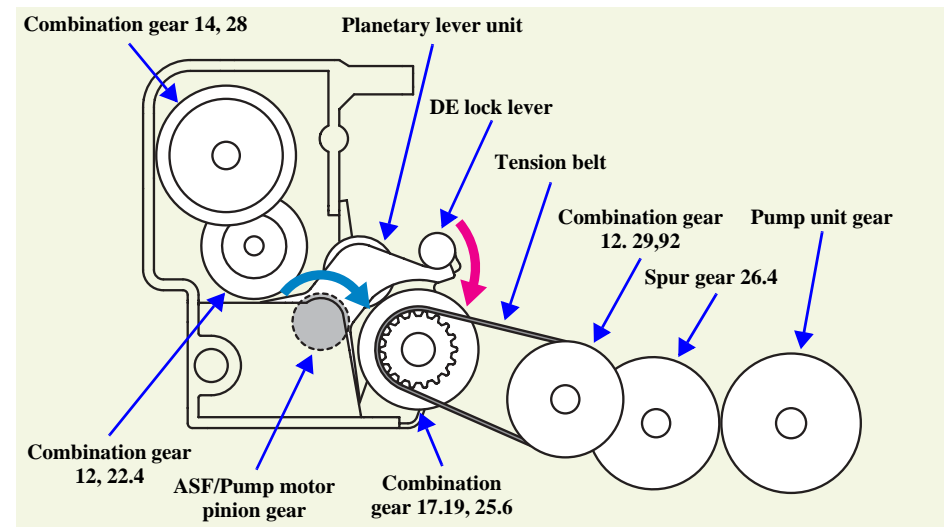


Figure 2-13. DE Mechanism Outline

The following diagram shows the pump operating principle.

1. When the Pump unit is rotated by the ASF/Pump motor in the CW direction, the turning roller presses the tube. Therefore, ink is fed from the Cap unit toward the Waste ink pad.
2. When the Pump unit is rotated by the ASF/Pump motor in the CCW direction, the roller moves away from the tube and does not press the tube, and ink is not sucked.

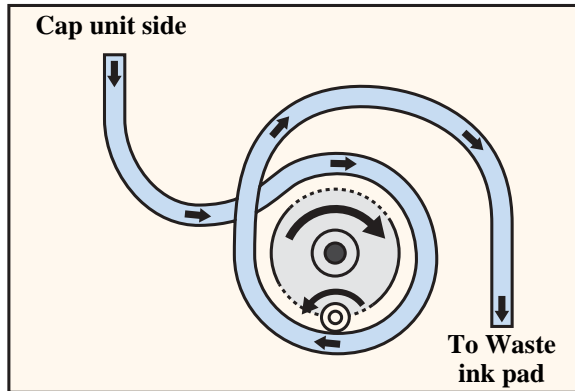


Figure 2-14. Pump Operating Principle

2.2.5.3 Capping Mechanism

The Capping mechanism uses the driving force of the Pump unit to come into close contact with the Head surface to suck ink from the Ink cartridges, Head and Cap, thereby securing air tightness in the Cap. When the printer is in a standby status or its power is OFF, the Capping mechanism is in close contact with the Head surface to secure moisture retention in the Cap, preventing the Head from being clogged with ink while the printer is stored. The following diagram shows the outline of capping operation.

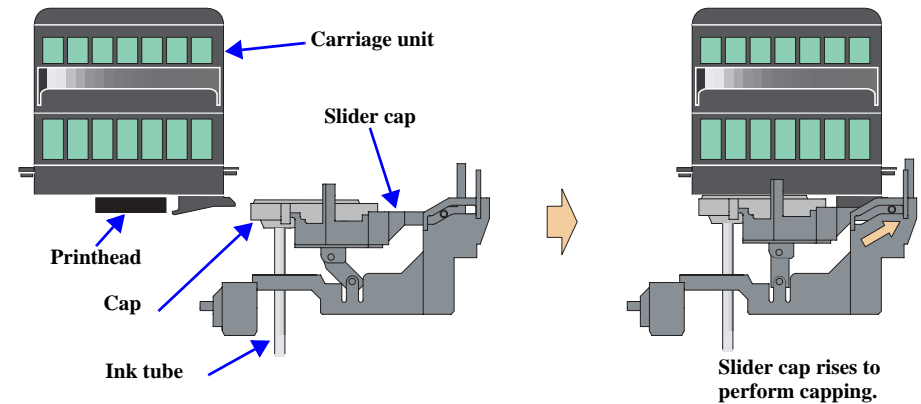


Figure 2-15. Capping Mechanism

2.2.6 Ink Sequence

The following ink sequence is executed according to various timer, counter, flag and other information saved on the EEPROM.

□ CSIC-related sequence

The ink type 1 code stored in the CSIC memory chip is identical regardless of the Japanese domestic or overseas cartridges, and is saved at the main board EEPROM A0<H> - A7<H>.

If data is read from each color CSIC and Ink cartridge error is not displayed at power-on, Ink end error is displayed. If the read data have no problems, the CSIC data status is made valid.

After CSIC operation is checked, the ink consumption of the I/C currently installed per color is compared with the ink consumption saved in the printer EEPROM, and control is performed under the following conditions.

■ When current I/C consumption differs (from ink consumption in EEPROM)

1. On the assumption that the I/C has been changed at power-off, the first I/C flag is reset.
2. The installation count in the printer EEPROM is updated for the CSIC. In the CSIC information replacement sequence, the CSIC side ink consumption data is updated to the ink consumption data in the printer EEPROM.
3. The used model name data on the I/C side is rewritten.

Note: Reason why the used model name data is rewritten from the printer to the I/C:
To grasp which printer used the I/C removed.

4. After that, the change flag 2 (flag that indicates change CL) is set and CL is executed. If the ink set (Line A, Line B) of the current I/C differs from the ink set in the EEPROM, replacement CL3 is executed.

■ When current I/C consumption is the same (as ink consumption in EEPROM)

1. When the initial filling flag is set and the CSIC side ink consumption is 0, the printer judges that initial filling is not yet performed.
(The printer before initial filling judges that the I/C is fitted in a power-off status.)
2. Installation count updating, CSIC information replacement, and initial filling are executed in this order.
3. If the initial filling flag is not set, the printer judges that I/C change was not made at power-off and regards the CSIC data as valid.

Data is written to the CSIC at power-off, in the power saving mode, at the time of cartridge change, or at the time of cleaning.

1. Data is read from the CSIC and developed in the RAM on the main board.
2. The data is compared with the ink consumption in the printer EEPROM. If the data are the same, the data is written to the CSIC. If they are different, only the consumed difference is added and written to the CSIC. When cleaning is performed, the CL count is also written, and when the I/C is changed, the installation count is also written.

□ Initial ink filling

When the printer is powered on for the first time after the purchase of the product, the printer executes the initial ink filling operation to fill the ink cavities of the Head with ink. When the initial ink filling operation is performed properly, the printer clears the flag in the EEPROM so that initial ink filling operation will not be performed when it is powered on next. The Stylus PHOTO 2100/2200 requires about 90 seconds to perform the initial ink filling operation and consumes about 1/7 of the new monochrome ink cartridge.

If the sequence does not end normally during initial filling, the initial filling flag is not cleared and the CL operating flag is set. Because of these flags, when powered on next time, the printer assumes that it was powered off for some reason during initial filling and executes CL3 instead of the initial filling sequence. (On the conventional mode, initial filling was executed again. However, when this operation was performed, ink was wasted and therefore CL3 is executed to cover the ink filling performance.)

When the initial filling flag is set and the CL operating flag is not set, the printer assumes that the initial filling was not executed at all (power was switched on but the cartridges were not set), and when the printer is powered on next time, it executes initial filling.

□ Replacement cleaning, change cleaning

This product has three patterns of black ink combinations in Lines A and B. Refer to Table 2-3 "Relationships between Nozzle Lines and Color Arrangement" on page 44.

When the Carriage is within the home position and the ink types of Lines A and B are changed within the above patterns during ink cartridge change, three different replacement CLs are executed depending on the ink types to prevent mixture of the old ink and new ink.

If the ink types of Lines A and B are not changed, change CL is executed instead of replacement CL.

If the color of the ink after replacement is lighter in replacement CL, replacement CL2 or replacement CL3 larger in flushing amount is selected and executed.

When ink cartridge change is made, change CL1 is executed for the nozzle lines other than A and B. (Replacement CL is not applied.)

As the ink consumption, total suction is 1.35g and 2.12 x 106 of each color is added. The differences between replacement CLs are differences in the flushing amount of Lines A and B.

- Cartridge replacement CL1: Each color
Approx. 1.484g (0.212g per color)
- Cartridge replacement CL2: Each color
Approx. 1.484g (0.212g per color)
- Cartridge replacement CL3: Each color
Approx. 1.484g (0.212g per color)
- Cartridge change CL1: Each color
Total suction 2.135g (0.305g per color)

□ Manual cleaning

This product provides four different manual cleanings to remove ink coagulated by air bubbles, viscous material or foreign matter. Perform the following manual CL operations by operating the panel or using the utility included in the printer driver.

Independently of the printing path after the previous CL, perform manual CL from CL1 to CL4 in order if the cumulative printing timer counter is less than 2H. Only when the cumulative printing timer counter is more than 2H, execute only CL1.

■ CL1: Each color

- Ink suction
0.889g (0.127g per color)
- Wiper operation
Clean the nozzle surface with the right-half rubber part of the wiper.
- Flushing operation
Prevent color mixture. Stabilize the ink surface inside the nozzles.

■ CL2: Each color

- Ink suction
1.827g (0.261g per color)
- Wiper operation
Clean the nozzle surface with the right-half rubber part of the wiper.
- Flushing operation
Prevent color mixture. Stabilize the ink surface inside the nozzles.

■ CL3: Each color

- Ink suction
3.885g (0.555g per color)
- Wiper operation
Clean the nozzle surface with the right-half rubber part of the wiper.
- Flushing operation
Prevent color mixture. Stabilize the ink surface inside the nozzles.

■ CL4: Each color

- Ink suction
4.004g (0.572g per color)
- Wiper operation
Clean the nozzle surface with the right-half rubber part of the wiper.
- Flushing operation
Prevent color mixture. Stabilize the ink surface inside the nozzles.

When the nozzle check pattern and the above manual CL are executed alternatively, the cleaning order is CL1 to CL2 to CL3 to CL4 to CL1.

If the remaining ink amount of the monochrome or color I/C is short or the I/C is in an Ink low/end status, all manual cleanings are disabled and STM3 shows the condition.

❑ Timer cleaning

This printer consumes the ink of up to 1.27g/color depending on the combination of the cumulative printing timer, cumulative cleaning count and cleaning timer.

❑ Flushing

This printer executes two different flushings for the following purposes.

■ Periodic flushing

This is done to prevent ink viscosity in the Printhead nozzles from increasing during continuous printing. A specific small amount of ink is discharged into the Cap according to the Periodic flushing timer.

■ Periodic large-amount flushing

This is done to prevent ink viscosity in the Printhead nozzles from increasing during continuous printing. A large amount of ink is discharged into the Cap according to the Periodic large-amount flushing timer.

2.2.7 Paper Cutter Mechanism

The Paper cutter mechanism consists of such main parts as the Cutter motor, left and right HP sensors (2 pcs. in all), Relay board, Paper eject roller shaft and Paper hold-down flap in the Cutter unit.

❑ Operation during printing

When the Cutter blade starts cutting, the Paper hold-down flap rises and holds the paper during cutting. The HP sensors for detection of the Cutter blade position are installed on both ends of the cutter operation area, detect whether the Cutter blade operates properly, and displays Cutter position error or Cutter jam error according to the operating condition.

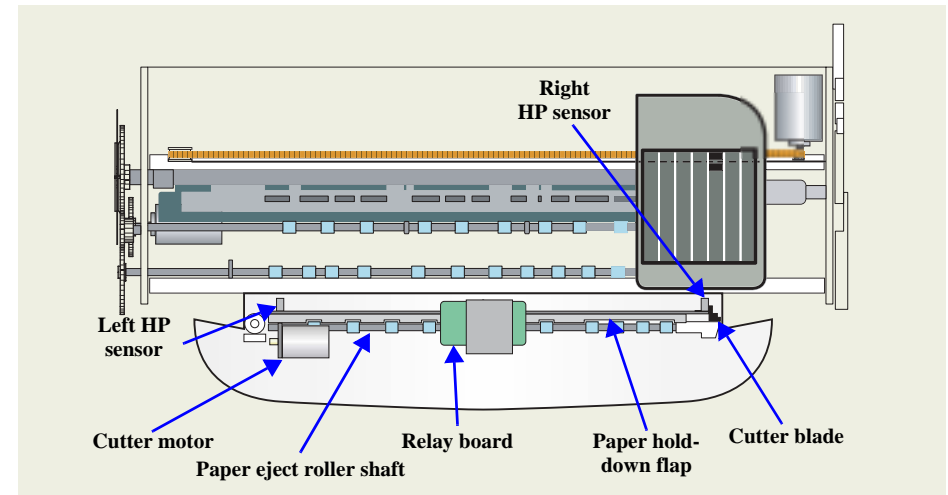


Figure 2-16. Cutter Mechanism

2.2.7.1 Cutter Initialization Sequence

When the Cutter is fitted, the cutter initialization sequence is executed if the printer has confirmed that the Cutter has been fitted (the Power switch blinks about 5 seconds). The cutter initialization sequence is an operation performed to securely put the Cutter blade in a standby position detected by the right HP sensor if the Cutter blade is not detected by the right HP sensor. In the initialization sequence, if the Cutter blade does not reach the HP sensor (right or left) within 3 seconds in either rightward or leftward Cutter motion, Cutter position error occurs. If the Cutter blade is in the right HP sensor position when the Cutter is fitted, the initialization operation is not performed specifically.

In Cutter operation, Cutter position error or Cutter jam error is detected. Differences between these errors are as follows.

Cutter jam error

If the Cutter blade does not reach the left or right HP sensor, the Cutter blade is returned to the HP sensor located in the motion starting position (right HP sensor). At this time, Cutter jam error occurs if the Cutter blade can return to the HP sensor position located in the motion starting position within 3 seconds.

Cutter position error

If the Cutter blade does not reach the left or right HP sensor, the Cutter blade is returned to the HP sensor located in the motion starting position (right HP sensor). At this time, Cutter position error occurs if the Cutter blade cannot return to the HP sensor position located in the motion starting position within 3 seconds.

Paper cutting by the Cutter consists of the basic cutting sequences 1 and 2. The basic sequence 1 means movement from the right HP sensor to the left HP sensor. At this time, as soon as the Cutter blade starts moving from the right HP sensor, the timer starts. If the left HP sensor does not detect the Cutter blade within 3 seconds, the cutter initialization sequence is executed and then Cutter jam error or Cutter position error occurs.

The basic cutting sequence 2 means movement from the left HP sensor to the right HP sensor. At this time, if the Cutter blade cannot move from the left HP sensor to the right HP sensor within 3 seconds, Cutter position error occurs.

2.2.7.2 Cutter Self-cleaning

In the Cutter unit, there is a plate (plate where the paper print surface comes into contact) above the Paper hold-down flap. This sequence indicates the operation performed to hold down and remove the ink, which may stick to that plate, with the leading edge of the fed roll paper.

Since the Cutter blade must be operated left-to-right to operate the Paper hold-down flap, the Cutter blade generates operating noise during cutter self-CL when the roll paper is fed.

2.2.7.3 Cutter Cleaning (Driver Side)

This sequence is executed on the driver side. By cutting the roll paper three times (T.B.D.) at intervals of 6cm, the ink that may stick to the Cutter blade is removed to clean the Cutter blade.

2.2.8 Power-On Sequence

The following explains the operation to be performed when there is paper or no paper and the Carriage is inside or outside the HP with the printer powered on.

Without paper/Carriage inside HP (CR locked)

1. When power is switched on, the drive of the CR motor is transmitted to the Carriage through the timing belt.
2. Using the transmitted drive, the Carriage starts operation in the following path to seek for the home position.
 - Home position → Right frame → CR lock lever → Right frame → Home position
3. The drive from the PF motor is transmitted to the Paper eject roller shaft A and the CR is unlocked.
 - PF motor → Spur gear 76 → Combination gear 17, 24.5 → Spur gear 43 → Paper eject roller shaft A → CR lock
4. In the path indicated in Sequence 1, after the Carriage has moved to the right frame (second time), the drive of the ASF/Pump motor is transmitted to the LD roller shaft through each gear of the DE unit to rotate the LD roller shaft, placing the ASF unit in the home position.
 - ASF/Pump motor → Planetary lever unit → Combination gear 12, 22.4 → Combination gear 14, 28 → Spur gear 32 (ASF side) → LD roller shaft
5. The unlocked Carriage moves to the left frame and then returns to the right frame. The Carriage stops there for about 5 seconds, and during that period, the PF roller shaft and Paper eject roller shafts A, B start rotating slowly.
 - PF motor → Spur gear 76 (PF roller shaft) → Combination gear 17, 24.5 → Spur gear 43 → Paper eject roller shaft A
 - PF motor → Spur gear 76 (PF roller shaft) → Combination gear 17, 24.5 → Spur gear 62 → Paper eject roller shaft B
6. The PF roller shaft and Paper eject roller shafts A, B stop rotating once, but restart rotating suddenly. When the Carriage moves between the left and right frames again, the ASF unit returns to the pre-power-on status (initial status), and the Carriage returns to the home position and is fixed by the CR lock lever.

Without paper/Carriage outside HP

1. When power is switched on, the drive of the CR motor is transmitted to the Carriage through the timing belt.
2. Using the transmitted drive, the Carriage moves to the home position slowly.
3. When the Carriage reaches the home position, the PF roller shaft and Paper eject roller shafts A, B start running suddenly by the drive from the PF motor but stop soon, and the Carriage is fixed by the CR lock lever.
 - PF motor → Spur gear 76 (PF roller shaft) → Combination gear 17, 24.5 → Spur gear 43 → Paper eject roller shaft A
 - PF motor → Spur gear 76 (PF roller shaft) → Combination gear 17, 24.5 → Spur gear 62 → Paper eject roller shaft B
4. After that, the operation as in "Without paper/Carriage inside HP" is performed.

With paper/Carriage inside HP (CR locked)

Operation is the same as in "Without paper/Carriage inside HP". When there is paper, however, the operation performed when the ASF unit detects the home position will be explained here additionally. The following operation is the same as in "Without paper/Carriage inside HP" or "Without paper/Carriage outside HP", provided that there is no paper.

1. The Paper return lever installed on the LD roller unit goes down to feed the paper but stops above the Paper separation pad.
2. After that, when the ASF unit returns to the pre-power-on status (initial status), the Paper return lever moves back the paper that was stopping above the Paper separation pad. This is done to prevent double feed during paper feeding.
3. The Carriage is fixed by the CR lock lever.

With paper/Carriage outside HP

In addition to the operation in "Without paper/Carriage outside HP", the motion of the Paper return lever in "With paper/Carriage inside HP" is performed.

2.3 Electrical Circuitry Operating Principles

The electrical circuitry of this product consists of the following circuits.

- Control circuit board
C387 MAIN
- Power supply circuit board
C387 PSB/PSE
- Control panel board
C387 PNL

The following shows how the three circuit boards are connected.

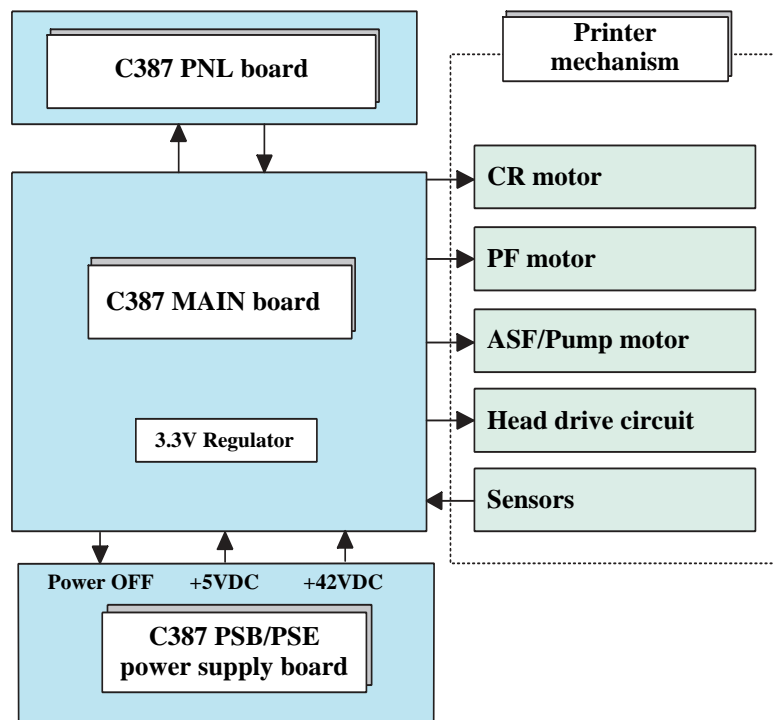


Figure 2-17. Electrical Circuitry Block Diagram

2.3.1 Power Supply Circuit Operating Principle

The power supply circuit board of this product is the C387 PSB/PSE. The basic structure of the circuit uses the RCC switching regulator method and +42VDC and +5VDC are supplied to the printer mechanism and control boards.

The following indicates the applications of the voltages generated in this power supply circuit.

Table 2-15. Supplied Power

Voltage	Applications
+42 +/- 2VDC Rated output current: 0.5A	<ul style="list-style-type: none"> • CR motor • ASF/Pump motor • PF motor • Head drive voltage
+5 +/- 0.25VDC Rated output current: 0.6A	<ul style="list-style-type: none"> • Logic sensor circuit • Panel LED • Nozzle selection circuit (above Printhead) • Interface control circuit • Ink cartridge sensor • PE sensor • ASF sensor • Cutter HP sensors (left, right)

Note: +5VDC applies to only the parts and areas in the above table. 3.3V/2.5V drive components are used as most logic chips (CPU, P-ROM, SDRAM) on the C387MAIN board. Hence, they do not operate at the +5VDC regulator DC generated by the C387PSB/PSE. Each 3.3V/2.5V drive chip operates at 3.3V/2.5V reduced by the 3.3V/2.5V generating regulator on the MAIN board circuit.

The following is the block diagram of the power supply circuit.

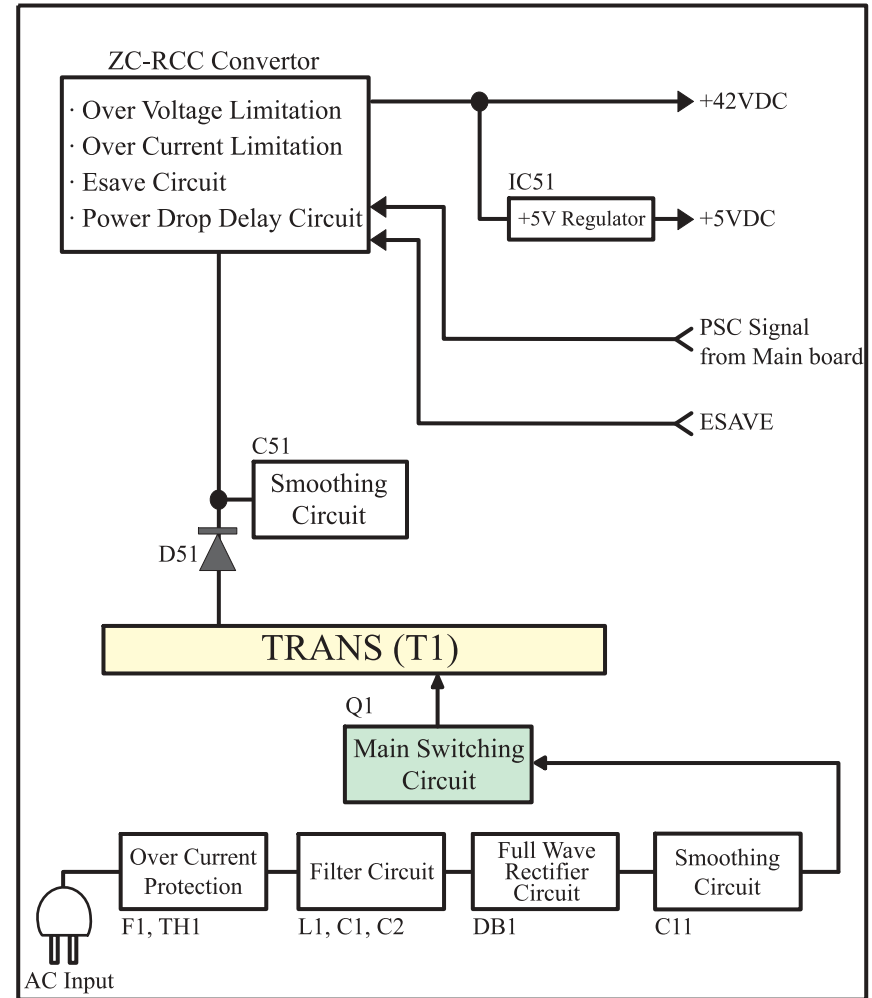


Figure 2-18. Power Supply Circuit Block Diagram

2.3.2 C387MAIN Circuit Operating Principle

The C387MAIN board consists of the logic circuits (CPU, ASIC, PROM, SDRAM, 1394 controller, USB2.0 controller), various motor control/drive circuits (CR motor, PF motor, ASF/Pump motor), head control/drive circuit, interfaces (1284, USB, 1394, USB2.0), sensor circuits, combination circuits (RTC, reset, EEPROM) and electrical double-layer capacitor.

There are the following two great differences between the control circuits of this product and conventional model.

- Adoption of 3.3V/2.5V drive logic circuit components

The 3.3V/2.5V voltage is generated by the Regulator ICs (IC15, IC31) installed on the C387MAIN board that reduces +5VDC generated by the C387PSB/PSE board, and is used to drive multiple components. This is done to save power of the logic circuit.

The following table indicates the 3.3V/2.5V drive components and 5V drive components.

Table 2-16. 3.3V/2.5V and 5V Drive Components

+5V	3.3V/2.5V
<ul style="list-style-type: none"> • Linear encoders (CR, PF) • Ink cartridge sensor • Interface circuit • Panel LED • PE sensor • ASF sensor • Nozzle selection circuit (above Printhead) • Cutter HP sensors (left, right) 	<ul style="list-style-type: none"> • CPU • P-ROM (SOJ) • SDRAM • Sensors (other than ink cartridge sensor, PE sensor and ASF sensor) • Interface circuit • USB2.0 controller ASIC • RTC, reset, EEPROM combination circuit

- Installation of hybrid circuit (IC9)

The hybrid circuit (IC9) installed consists of three different circuits, EEPROM, RTC and reset.

By adoption of the large-capacity capacitor for timer, the Power-off timer can be backed up for about one week after power-off.

The following is the block diagram of the C387MAIN control board.

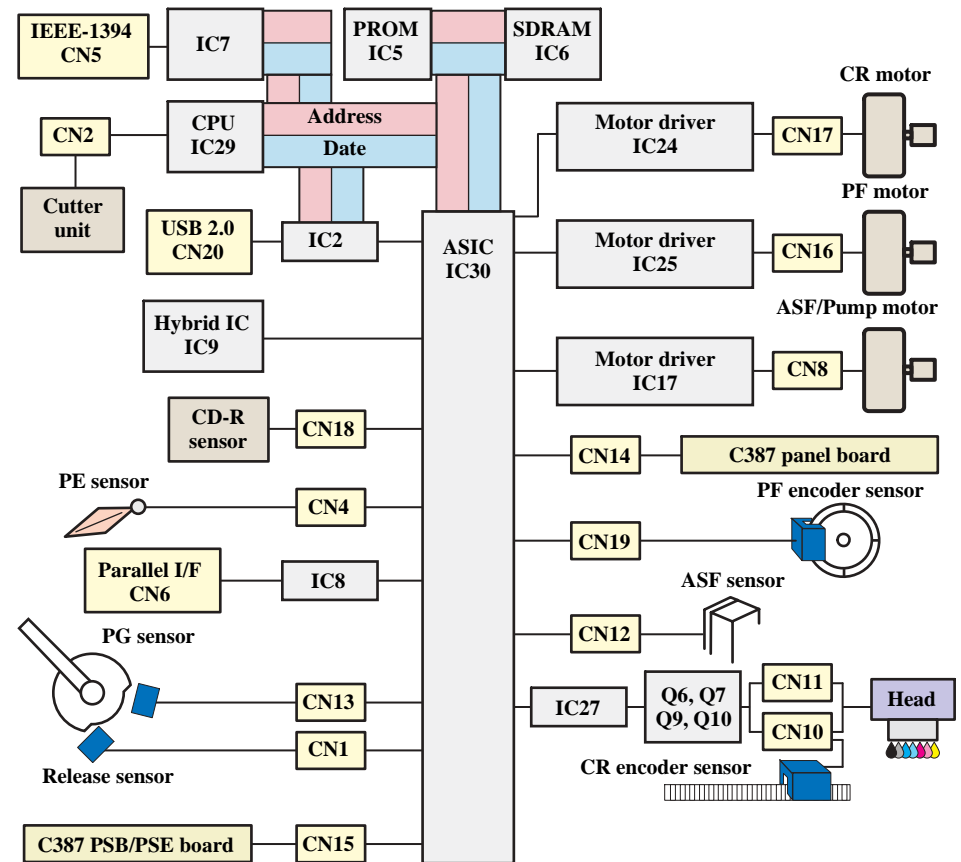


Figure 2-19. C387MAIN Control Board Block Diagram

CHAPTER

3

TROUBLESHOOTING



3.1 Overview

This chapter describes unit-level troubleshooting.

3.2 Error Indications and Fault Occurrence Causes

This section explains the LED indications, EPW3 messages and fault occurrence causes at occurrence of the following errors during any sequence/operation (e.g. power-on sequence, paper feeding/loading sequence, ink sucking sequence).



Table 3-1. Error Indications and Fault Occurrence Causes

Printer Condition	Indicators			EPSON Printer Window 3	Fault Occurrence Cause
	Power	Paper	Ink 1-7		
Communication Error	-	-	-		<p>This error is detected when the printer cannot communicate with the PC properly.</p> <p>Examples are as follows.</p> <ol style="list-style-type: none"> 1. The connection port differs from the port used on the driver. 2. Main board fault. 3. Power supply board fault. <p>CAUTION: Since D4 is also supported by the parallel interface, communication can be made if Fatal error occurs. Therefore, this error is narrowed down to the above causes.</p>
Model Difference	-	-	-		<p>This error is detected if a different product is connected to the printer driver.</p> <ol style="list-style-type: none"> 1. Mismatch between the printer driver and product 2. The EEPROM E0<H> area data differs from the specifications.

"-" : don't care
 Blink : 0.5sec on + 0.5sec off repetition
 Blink 2 : 0.2sec on + 0.2sec on + 0.2sec on 0.4sec off repetition



High speed Blink : 0.1sec on + 0.1sec off repetition
 Blink alternately 1 : 0.5sec on + 0.5sec off repetition
 Blink alternately 2 : 0.5sec on + 0.5sec on repetition

Table 3-1. Error Indications and Fault Occurrence Causes

Printer Condition	Indicators			EPSON Printer Window 3	Fault Occurrence Cause
	Power	Paper	Ink 1-7		
Release Lever Error	-	High speed Blink	-		This error is detected in the following case. The Release lever is in the release position, or when the CD-R tray is not fitted (Only for Stylus PHOTO 2100), in the CD-R printing position.
Paper Out Error	-	On	-		This error is detected in any of the following cases. 1. The paper is not set to the right Edge guide. 2. The PE sensor cannot detect the lower end of the paper in paper feeding operation. 3. When the CD-R tray was fitted, the CD-R was not detected and the Tray was ejected. (Only for Stylus PHOTO 2100) 4. The CD-R tray home position was not detected properly and the Tray was ejected. (Only for Stylus PHOTO 2100)



"-"	: don't care	High speed Blink	: 0.1sec on + 0.1sec off repetition
Blink	: 0.5sec on + 0.5sec off repetition	Blink alternately 1	: 0.5sec on + 0.5sec off repetition
Blink 2	: 0.2sec on + 0.2sec on + 0.2sec on 0.4sec off repetition	Blink alternately 2	: 0.5sec on + 0.5sec on repetition

Table 3-1. Error Indications and Fault Occurrence Causes

Printer Condition	Indicators			EPSON Printer Window 3	Fault Occurrence Cause
	Power	Paper	Ink 1-7		
Paper Jam Error	-	Blink	-		This error is detected when the paper remaining near the PE sensor cannot be ejected in the paper loading sequence, or if the paper near the PE sensor cannot be ejected with the FF command or Paper switch.
Paper Gap Error	-	On	-		This error is detected if the printer judges that the Carriage made contact with the paper, which was fed from the Paper guide manual (Board paper feeding port), at the time of paper width detection.

"-"	: don't care	High speed Blink	: 0.1sec on + 0.1sec off repetition
Blink	: 0.5sec on + 0.5sec off repetition	Blink alternately 1	: 0.5sec on + 0.5sec off repetition
Blink 2	: 0.2sec on + 0.2sec on + 0.2sec on 0.4sec off repetition	Blink alternately 2	: 0.5sec on + 0.5sec on repetition



Table 3-1. Error Indications and Fault Occurrence Causes

Printer Condition	Indicators			EPSON Printer Window 3	Fault Occurrence Cause
	Power	Paper	Ink 1-7		
Double Feed Error	-	On	-		This error is detected if a paper feeding displacement occurred between the overlapped pieces of paper that were fed in the Duplex printing mode.
Ink Combination Error	-	-	High speed Blink		This error is detected if the Ink cartridges of the color/type combination not found in the specifications were inserted during ink change. Example: If Photo-black is inserted into Line A and Matte-black into Line B, this error appears since this combination does not exist in the specifications.

"-" : don't care
 Blink : 0.5sec on + 0.5sec off repetition
 Blink 2 : 0.2sec on + 0.2sec on + 0.2sec on 0.4sec off repetition



High speed Blink : 0.1sec on + 0.1sec off repetition
 Blink alternately 1 : 0.5sec on + 0.5sec off repetition
 Blink alternately 2 : 0.5sec on + 0.5sec on repetition

Table 3-1. Error Indications and Fault Occurrence Causes

Printer Condition	Indicators			EPSON Printer Window 3	Fault Occurrence Cause
	Power	Paper	Ink 1-7		
Ink Color Error	-	-	High speed Blink		This error is detected if Ink end/low occurs during printing and the new Ink cartridge inserted for ink change differs in color/type from the old Ink cartridge.
Ink Level Low Error	-	-	Blink	 CAUTION: If the EPW3 shows the error, printing can be continued until the printer is placed in the ink end status. However, you cannot perform head cleaning operation.	This error is detected if the ink consumption reaches about 90%.

- | | | | |
|---------|---|---------------------|-------------------------------------|
| "-" | : don't care | High speed Blink | : 0.1sec on + 0.1sec off repetition |
| Blink | : 0.5sec on + 0.5sec off repetition | Blink alternately 1 | : 0.5sec on + 0.5sec off repetition |
| Blink 2 | : 0.2sec on + 0.2sec on + 0.2sec on 0.4sec off repetition | Blink alternately 2 | : 0.5sec on + 0.5sec on repetition |



Table 3-1. Error Indications and Fault Occurrence Causes

Printer Condition	Indicators			EPSON Printer Window 3	Fault Occurrence Cause
	Power	Paper	Ink 1-7		
Ink End Error	-	-	On		This error is detected in either of the following cases. 1. The ink consumption reached 100%. 2. The Ink cartridge is faulty. (CSIC memory data error) CAUTION: If Ink end error is detected, a small amount of ink remains in the Ink cartridge to protect the Printhead from printing operation.
No Ink Cartridge / Ink Cartridge Error	-	-	On (Corresponding Ink LED only)		This error is detected in either of the following cases. 1. Any of the Ink cartridges is not fitted or has come off. 2. The CSIC information of the Ink cartridge cannot be read or written properly.

"-" : don't care
 Blink : 0.5sec on + 0.5sec off repetition
 Blink 2 : 0.2sec on + 0.2sec on + 0.2sec on 0.4sec off repetition



High speed Blink : 0.1sec on + 0.1sec off repetition
 Blink alternately 1 : 0.5sec on + 0.5sec off repetition
 Blink alternately 2 : 0.5sec on + 0.5sec on repetition

Table 3-1. Error Indications and Fault Occurrence Causes

Printer Condition	Indicators			EPSON Printer Window 3	Fault Occurrence Cause
	Power	Paper	Ink 1-7		
Cutter Jam Error	-	Blink 2	-		This error is detected if the paper could not be cut properly due to overload after Cutter operation but the Cutter could return to the home position.
Cutter Position Error	Off	Blink 2	Blink 2		This error is detected if the paper cannot be cut properly due to overload during Cutter operation and the Cutter cannot return to the home position.

"-"	: don't care	High speed Blink	: 0.1sec on + 0.1sec off repetition
Blink	: 0.5sec on + 0.5sec off repetition	Blink alternately 1	: 0.5sec on + 0.5sec off repetition
Blink 2	: 0.2sec on + 0.2sec on + 0.2sec on 0.4sec off repetition	Blink alternately 2	: 0.5sec on + 0.5sec on repetition

Table 3-1. Error Indications and Fault Occurrence Causes

Printer Condition	Indicators			EPSON Printer Window 3	Fault Occurrence Cause
	Power	Paper	Ink 1-7		
Maintenance Request	Off	Blink alternately 1	Blink alternately 2		<p>This error is detected when the Waste ink counter A0 stored in the EEPROM reaches the limit (60352 points). The error detection timing is as follows.</p> <ul style="list-style-type: none"> • At power-on • At data transmission • At cleaning • At flushing
Fatal Error	Off	High speed Blink	High speed Blink		<p>This error is detected in any of the following cases.</p> <ol style="list-style-type: none"> 1. The CR unit does not operate properly due to external force in any sequence/operation. 2. The PF motor does not rotate properly during PF motor operation. 3. The home position cannot be detected by the ASF sensor.

"-" : don't care
 Blink : 0.5sec on + 0.5sec off repetition
 Blink 2 : 0.2sec on + 0.2sec on + 0.2sec on 0.4sec off repetition

High speed Blink : 0.1sec on + 0.1sec off repetition
 Blink alternately 1 : 0.5sec on + 0.5sec off repetition
 Blink alternately 2 : 0.5sec on + 0.5sec on repetition

3.3 Troubleshooting

After checking the printer LED and EPW3 error indications, you can grasp the fault location using the check list in this section. When you have found the fault location, refer to Chapter 4 "Disassembly and Reassembly" and change the corresponding part and/or unit. The following table gives the corresponding table numbers that indicate the check points corresponding the error states (LED and EPW3).

Table 3-2. Reference Tables of Error States

Error State	Reference Table
Communication Error	Refer to Table 3-3 "Phenomenon-Based Communication Error Check Points" on page 79.
Model Difference	Refer to Table 3-3 "Phenomenon-Based Communication Error Check Points" on page 79.
Release Lever Error	Refer to Table 3-4 Phenomenon-Based Release Lever Error Check Points on page 82.
Paper Out Error	Refer to Table 3-5 Phenomenon-Based Paper Out Error Check Points on page 83.
Paper Jam Error	Refer to Table 3-6 Phenomenon-Based Paper Jam Error Check Points on page 87.
Paper Gap Error	Refer to Table 3-7 "Phenomenon-Based Paper Gap Error Check Points on page 89.
Double Feed Error	Refer to Table 3-8 Double Feed Error State Check Points on page 89.
Ink Combination Error	Refer to Table 3-9 Phenomenon-Based Ink Combination Error Check Points on page 89.
Ink Color Error	Refer to Table 3-10 Phenomenon-Based Ink Color Error Check Points on page 90.
Ink Level Low Error	Refer to Table 3-11 Phenomenon-Based Ink Level Low Error Check Points on page 90.
Ink End Error	Refer to Table 3-12 Phenomenon-Based Ink End Error Check Points on page 90.
No Ink Cartridge/Ink Cartridge Error	Refer to Table 3-13 Phenomenon-Based No Ink Cartridge/Ink Cartridge Error Check Points on page 91.
Cutter Jam Error	Refer to Table 3-14 Phenomenon-Based Cutter Jam Error Check Points on page 93.
Cutter Position Error	Refer to Table 3-15 Phenomenon-Based Cutter Position Error Check Points on page 94.
Maintenance Request	Refer to Table 3-16 Phenomenon-Based Maintenance Request Check Points on page 95.
Fatal Error	Refer to Table 3-17 Phenomenon-Based Fatal Error Check Points on page 96.

Table 3-3. "Phenomenon-Based Communication Error Check Points"

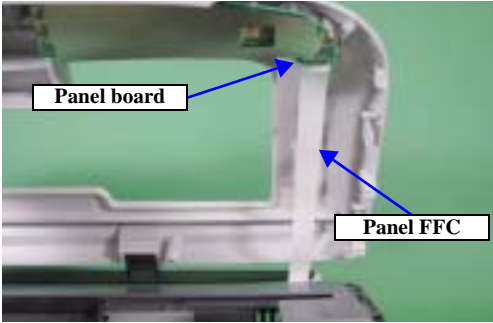
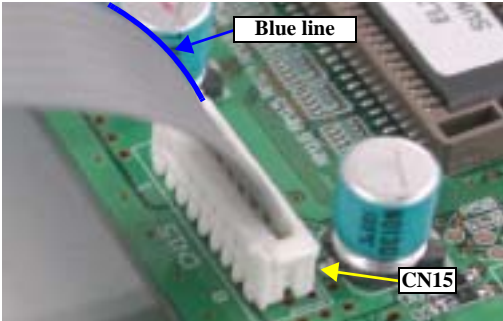
Occurrence Timing	Phenomenon Detail	Faulty Part/ Part Name	Check Point	Remedy
At power-on	The printer does not operate at all.	Panel FFC	1. Check that the Panel FFC is connected to the connector of the Panel board correctly. 	1. Connect the Panel FFC to the connector of the Panel board correctly. 2. Change the Panel FFC for a new one.
		Panel board	1. Check the Panel board for damage.	1. Change the Panel board for a new one.
		Power supply board	1. Check that the connector cable of the Power supply board is connected to CN15 on the Main board. 	1. Connect the connector cable of the Power supply board to CN15 on the Main board. 2. Connect the Power supply board connector cable with the blue-lined side placed on the 1 pin side.

Table 3-3. "Phenomenon-Based Communication Error Check Points"

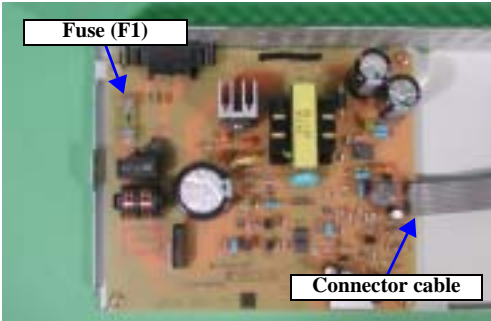
Occurrence Timing	Phenomenon Detail	Faulty Part/ Part Name	Check Point	Remedy
At power-on	The printer does not operate at all.	Power supply board	3. Check that the Fuse (F1) on the Power supply board is not blown.  4. Check the devices on the Power supply board for damage. 5. Check the connector cable of the Power supply board for damage.	3. Change the Fuse (F1) for a new one. 4. Change the Power supply board for a new one. 5. Change the Power supply board for a new one.
		Interface cable	1. Check that the Interface cable is connected between the PC and printer. 2. Check the Interface cable for wire break.	1. Connect the Interface cable to the PC and printer. 2. Change the Interface cable for a new one.
At operation	Operation at power-on is normal, but the error appears when the print jog is sent to the printer.	EPSON USB driver	1. When USB is used, check that the EPSON USB driver has been installed in the PC.	1. Install the EPSON USB driver.

Table 3-3. "Phenomenon-Based Communication Error Check Points"

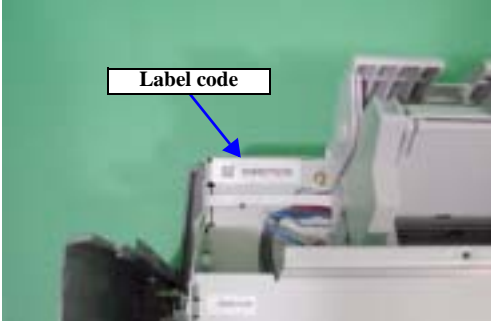
Occurrence Timing	Phenomenon Detail	Faulty Part/ Part Name	Check Point	Remedy
At operation	Operation at power-on is normal, but the error appears when the print jog is sent to the printer.	IEEE1394	1. Check that the same code as the IEEE1394 QR label code is saved at D4<H> to D8<H> of the EEPROM. 	1. Input the code given as the IEEE1394 QR label code.
		Printer driver	1. Check that the Stylus PHOTO 2100/2200 printer driver has been installed. 2. Check that the connected printer is the Stylus PHOTO 2100/2200.	1. Install the Stylus PHOTO 2100/2200 printer driver. 2. Connect the Stylus PHOTO 2100/2200 printer.
		Main board	1. Check that a wrong model name has not been input to the EEPROM address, E0<H>, on the Main board.	1. Using the adjustment program, enter the correct model name (save 02 into E0<H>).

Table 3-4. Phenomenon-Based Release Lever Error Check Points

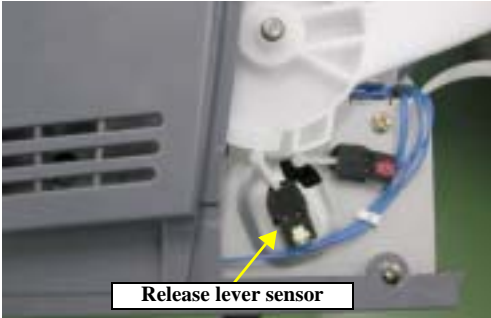
Occurrence Timing	Phenomenon Detail	Faulty Part/ Part Name	Check Point	Remedy
At power-on	At power-on, the Paper guide of the Printer mechanism is open and Release lever error is displayed.	Release lever	<ol style="list-style-type: none"> 1. Check that the Release lever is not in the far position, or when the CD-R tray is not fitted (Only for Stylus PHOTO 2100), is not in the CD-R printing position. 2. Check that the Release lever is not in other than the CD-R printing position when the CD-R tray is fitted. (Only for Stylus PHOTO 2100) 	<ol style="list-style-type: none"> 1. Move the Release lever to the front or thick paper printing position. 2. Move the Release lever to the CD-R printing position. (Only for Stylus PHOTO 2100)
	The Release lever is in the front position and the Paper guide is closed but Release lever error is displayed.	Release lever sensor	<ol style="list-style-type: none"> 1. Check that the Release lever sensor connector cable is connected to the Release lever sensor and Main board (CN1) securely. <div data-bbox="949 587 1442 906" style="text-align: center;">  <p>Release lever sensor</p> </div> <ol style="list-style-type: none"> 2. Move the Release lever sensor detection lever manually in the same state as when the Release lever makes contact with the Detection lever, and check that the Detection lever returns to the original position automatically when released. 3. Using a tester, check that the Release lever sensor is normal. <ul style="list-style-type: none"> • Connector (CN1) <ul style="list-style-type: none"> Open : 3.3V Not open : 0V 	<ol style="list-style-type: none"> 1. Connect the Release lever sensor connector cable to the Release lever sensor and Main board (CN1) securely. 2. Change the Release lever sensor for a new one. 3. Change the Release lever sensor for a new one.

Table 3-5. Phenomenon-Based Paper Out Error Check Points

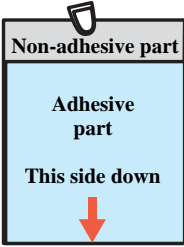
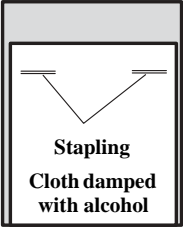
Occurrence Timing	Phenomenon Detail	Faulty Part/ Part Name	Check Point	Remedy
At operation	When the Paper switch was pressed, the LD rollers attempt to feed paper but the paper is not fed.	ASF unit	1. Check the Paper feed mechanism of the ASF unit for paper dust or foreign matter.	<p>1. Using a cleaning sheet, clean the Paper feed mechanism and Paper eject mechanism. The procedure is as follows.</p> <ol style="list-style-type: none"> 1 Place the cleaning sheet upside down and put it into the ASF unit. 2 Press the Paper switch to start paper feed. 3 Repeat the above steps several times. <p>* To remove persistent contamination, staple an alcohol-dampened cloth to a postcard and clean the rollers in the following method.</p> <div style="display: flex; justify-content: space-around; align-items: flex-start;"> <div style="text-align: center;"> <p>Cleaning sheet</p>  </div> <div style="text-align: center;"> <p>Postcard used as mount</p>  </div> </div> <ol style="list-style-type: none"> 1 Place the alcohol-dampened cloth toward the LD roller surface of the ASF. 2 Hold the mount top end securely and press the Paper feed switch. 3 Repeat the paper feed sequence several times to clean the LD roller surface of the ASF.

Table 3-5. Phenomenon-Based Paper Out Error Check Points

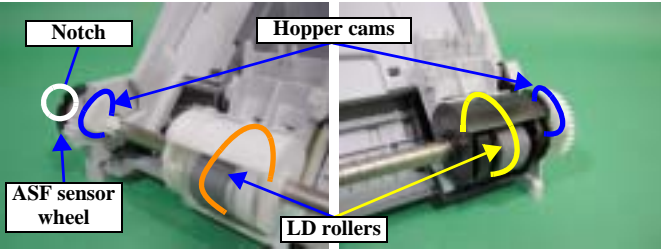
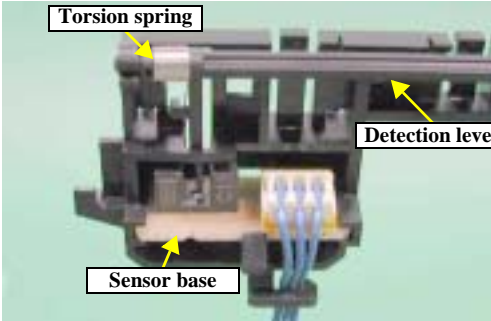
Occurrence Timing	Phenomenon Detail	Faulty Part/ Part Name	Check Point	Remedy
At operation	After start of printing operation, the LD rollers attempt to feed paper but the paper is not fed.	ASF unit	1. Check the Hopper cams, LD rollers and ASF sensor wheels for phase shifts. 	1. Match the phases and install the parts correctly.
	Paper is fed from the ASF but stops at the PE sensor lever.	PE sensor	1. Check that the PE sensor connector cable is connected securely to the PE sensor and Main board. (On Main board: CN4) 2. Move the Detection lever actively by hand in the same state as when the paper passes, and check that the Detection lever is returned to the original position automatically by the Torsion spring when released.  3. Check that the Sensor base is mounted to the Frame securely. (Refer to the above photo.) 4. Using a tester, check that the PE sensor is normal. <ul style="list-style-type: none"> • Connector (CN4) Paper present : 2.4V or more Paper absent : 0.4V or less 	1. Connect the PE sensor connector cable to the PE sensor and Main board securely. 2. Install the Torsion spring correctly or change the PE sensor for a new one. 3. Install the Sensor base securely. 4. Change the PE sensor for a new one.

Table 3-5. Phenomenon-Based Paper Out Error Check Points

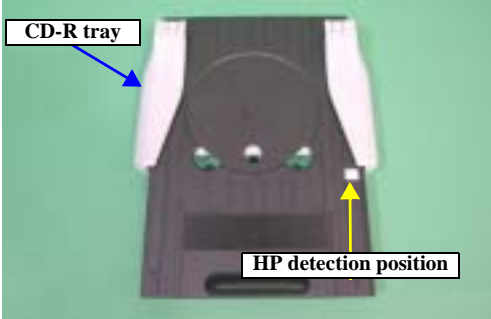
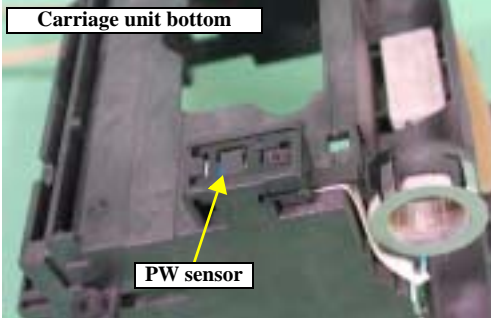
Occurrence Timing	Phenomenon Detail	Faulty Part/ Part Name	Check Point	Remedy
<p>The Paper feed switch was pressed at the setting of the CD-R tray. (Only for Stylus PHOTO 2100)</p>	<p>The CD-R tray is fed toward the ASF but is ejected immediately.</p>	<p>CD-R tray</p>	<ol style="list-style-type: none"> 1. Check the HP detection position of the CD-R tray for paper dust or foreign matter.  <ol style="list-style-type: none"> 2. Check the Driven roller surface for contamination such as paper dust and CD-R coating. 3. Check the HP detection position of the CD-R tray for contamination or damage. 	<ol style="list-style-type: none"> 1. Remove paper dust and/or foreign matter from the detection portion. 2. Pass plain paper of A3+ width from the ASF several times to remove contamination. 3. Change the CD-R tray for a new one.
		<p>PW sensor</p>	<ol style="list-style-type: none"> 1. Check the PW sensor for contamination such as paper dust.  <ol style="list-style-type: none"> 2. Compare the EEPROM 76<H> and BB<H> values and check that they are not approximate to each other. 	<ol style="list-style-type: none"> 1. Clean the PW sensor surface. 2. Change the PW sensor for a new one.

Table 3-5. Phenomenon-Based Paper Out Error Check Points

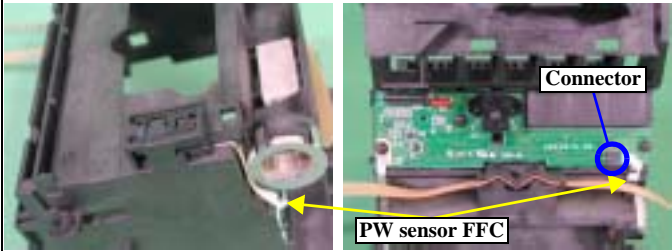
Occurrence Timing	Phenomenon Detail	Faulty Part/ Part Name	Check Point	Remedy
<p>The Paper feed switch was pressed at the setting of the CD-R tray. (Only for Stylus PHOTO 2100)</p>	<p>The CD-R tray is fed up to the Driven roller section toward the ASF, but is kept fed for some time toward the ASF and is then ejected.</p>	<p>PW sensor</p>	<p>1. Check that the PW sensor FFC is placed in the specified routing positions and does not make contact with any parts.</p>  <p>2. Check that the PW sensor FFC has not come off the connector of the CR encoder board. (Refer to the above photo.)</p>	<p>1. Place the FFC, which is connected to the PW sensor, in the specified routing positions.</p> <p>2. Securely connect the PW sensor FFC to the connector of the CR encoder board.</p>

Table 3-6. Phenomenon-Based Paper Jam Error Check Points

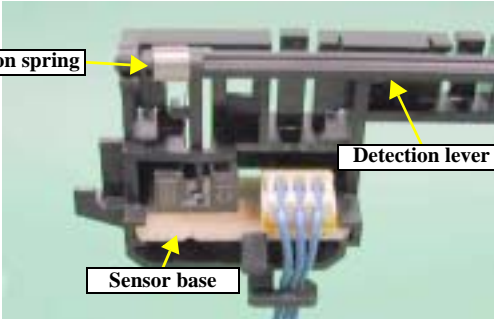
Occurrence Timing	Phenomenon Detail	Faulty Part/ Part Name	Check Point	Remedy
<p>At power-on (ASF, board paper feed mode only)</p>	<p>At power-on, the PF roller turns continuously for several seconds.</p>	<p>PE sensor</p>	<ol style="list-style-type: none"> 1. Check the paper detection area of the PE sensor for paper dust or foreign matter.  <ol style="list-style-type: none"> 2. Check that the PE sensor detection lever is in the proper position. 3. Check that the Sensor base is mounted to the Mechanical frame correctly. 4. Move the Detection lever actively by hand in the same state as when the paper passes, and check that the Detection lever is returned to the original position automatically by the Torsion spring when released. 	<ol style="list-style-type: none"> 1. Remove the paper dust and/or foreign matter from the detection area. 2. Install the PE sensor detection lever in the correct position. 3. Install the Sensor base correctly. 4. Change the PE sensor for a new one.
<p>At operation</p>	<p>At the time of paper ejection, the PF roller advances the paper but cannot eject it completely.</p>	<p>-</p>	<ol style="list-style-type: none"> 1. Check that the paper size used in the printer is not larger than the paper size set on the driver side. 	<ol style="list-style-type: none"> 1. Since the paper length is larger than the specifications, notify the user.

Table 3-6. Phenomenon-Based Paper Jam Error Check Points

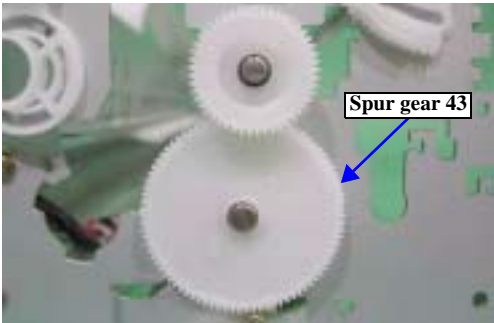

Occurrence Timing	Phenomenon Detail	Faulty Part/ Part Name	Check Point	Remedy
At operation	Paper is not ejected completely and causes a jam near the Paper eject frame.	ASF unit	1. Check that the paper is fed along the right Edge guide.	1. Feed the paper along the right Edge guide.
		Paper eject unit	1. Check the Paper eject unit for deformation or damage.	1. Change the Paper eject unit for a new one.
		Spur Gear 43 (Paper eject roller A)	1. Check the Spur gear 43 for damage. 	1. Change the Spur gear 43 for a new one.
		Spur gear 62 (Paper eject roller B)	1. Check the Spur gear 62 for damage. 	1. Change the Spur gear 62 for a new one.

Table 3-7. "Phenomenon-Based Paper Gap Error Check Points

Occurrence Timing	Phenomenon Detail	Faulty Part/ Part Name	Check Point	Remedy
Paper was fed from the Board paper guide and the Carriage executed paper locating control or paper width detection.	Thick paper is fed but not printed.	Release lever	<ol style="list-style-type: none"> 1. Check that the Release lever is not in the front position. 2. Check that the paper placed is not larger than 2.5mm thickness. 	<ol style="list-style-type: none"> 1. Place the Release lever in the thick paper printing position to increase the platen gap. 2. Change the paper for the paper of not more than 2.5mm thickness.

Table 3-8. Double Feed Error State Check Points

Occurrence Timing	Phenomenon Detail	Faulty Part/ Part Name	Check Point	Remedy
After the paper was printed on one side in the Duplex printing mode, it was placed in the ASF and fed to print the other side.	After both surfaces were printed, the paper was ejected but the error is displayed.	-	<ol style="list-style-type: none"> 1. When printing the other side after printing one side, check that the paper of another size (paper whose size is larger than the paper size printed earlier) has not been placed. 2. When printing the other side after printing one side, check that the paper was placed after its printed side had fully dried. 	<ol style="list-style-type: none"> 1. Use the same paper size for both sides. 2. Place the other side after fully drying the printed side.

Table 3-9. Phenomenon-Based Ink Combination Error Check Points

Occurrence Timing	Phenomenon Detail	Faulty Part/ Part Name	Check Point	Remedy
At ink cartridge changing	When you changed the Ink cartridge and pressed the Ink switch, the error appears on the LED and EPW3.	Ink cartridge	<ol style="list-style-type: none"> 1. Check that the Ink cartridge combination is proper. 2. Check the Ink cartridge used is the EPSON genuine part. 	<ol style="list-style-type: none"> 1. Combine the Ink cartridges correctly. The following two Ink cartridge combinations can be changed in Lines 1 and 2 on the left end of the Carriage. <ul style="list-style-type: none"> • Photo-black + gray • Matte-black + gray The Ink cartridges of the following improper combination can be inserted <ul style="list-style-type: none"> • Photo-black + Photo-black It is recommended to use the EPSON genuine parts.

Table 3-10. Phenomenon-Based Ink Color Error Check Points

Occurrence Timing	Phenomenon Detail	Faulty Part/ Part Name	Check Point	Remedy
The Ink cartridge was changed during printing due to Ink end/low.	When you changed the Ink cartridge and pressed the Ink switch, the error appears on the LED and EPW3.	Ink cartridge	1. Check that the old and new Ink cartridges are the same.	1. Insert the new Ink cartridge that is the same as the old one.

Table 3-11. Phenomenon-Based Ink Level Low Error Check Points

Occurrence Timing	Phenomenon Detail	Faulty Part/ Part Name	Check Point	Remedy
During printing	The message appears on the LED and EPW3 during printing.	Ink cartridge	1. Look at the remaining ink indication of the EPW3 to check the amount of the ink remaining in the Ink cartridge.	1. Prepare a new Ink cartridge.

Table 3-12. Phenomenon-Based Ink End Error Check Points

Occurrence Timing	Phenomenon Detail	Faulty Part/ Part Name	Check Point	Remedy
During printing	The error appears on the LED and EPW3 after the Carriage has returned to the home position.	Ink cartridge	1. Look at the remaining ink indication of the EPW3 to check whether the ink remains in the Ink cartridge.	1. Change the Ink cartridge for a new one.

Table 3-13. Phenomenon-Based No Ink Cartridge/Ink Cartridge Error Check Points


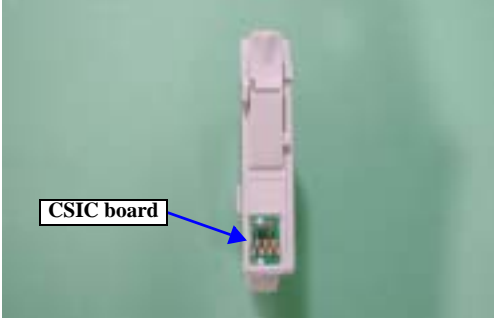
Occurrence Timing	Phenomenon Detail	Faulty Part/ Part Name	Check Point	Remedy
At power-on	After the Carriage has detected the home position, the error appears on the LED and EPW3.	Ink cartridge	<ol style="list-style-type: none"> 1. Check that the Ink cartridge is fitted properly. 2. Check the Ink cartridge hooks for breakage.  <ol style="list-style-type: none"> 3. Check the CSIC board has not come off. 	<ol style="list-style-type: none"> 1. Fit the Ink cartridge properly. 2. Change the Ink cartridge for a new one. <ol style="list-style-type: none"> 3. Change the Ink cartridge for a new one.

Table 3-13. Phenomenon-Based No Ink Cartridge/Ink Cartridge Error Check Points

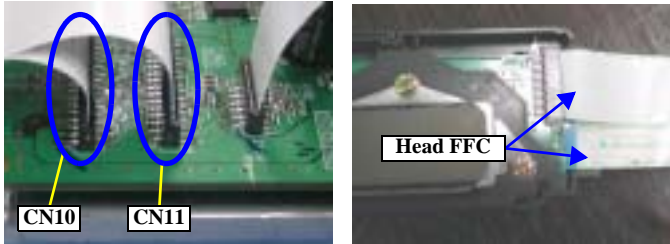
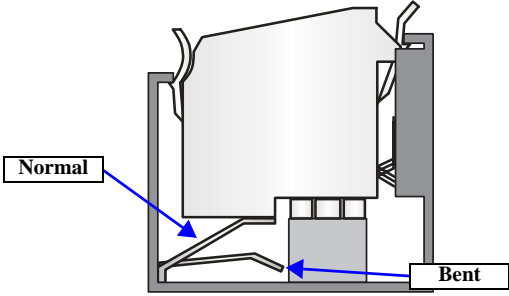
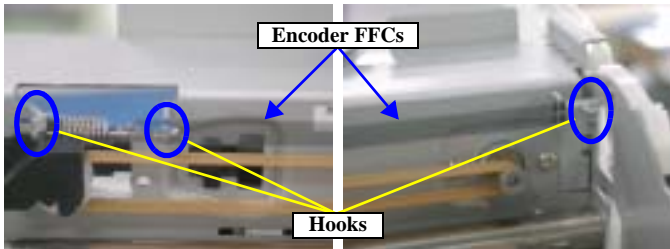
Occurrence Timing	Phenomenon Detail	Faulty Part/ Part Name	Check Point	Remedy
<p>At power-on</p>	<p>After the Carriage has detected the home position, the error appears on the LED and EPW3.</p>	<p>Carriage unit</p>	<ol style="list-style-type: none"> 1. Check that the Head FFC has not come off the Printhead and Main board. (On Main board: CN10, CN11)  <ol style="list-style-type: none"> 2. Check that the Plate spring is not bent.  <ol style="list-style-type: none"> 3. Check that the Electrode in the Carriage that makes contact with the CSIC board is not faulty. 	<ol style="list-style-type: none"> 1. Connect the Head FFC to the Printhead and Main board securely. 2. Change the Plate spring for a new one. 3. Change the Electrode for a new one.
		<p>CR encoder board</p>	<ol style="list-style-type: none"> 1. Check that the Encoder FFCs have not come off. 	<ol style="list-style-type: none"> 1. Connect the Encoder FFCs securely.

Table 3-14. Phenomenon-Based Cutter Jam Error Check Points

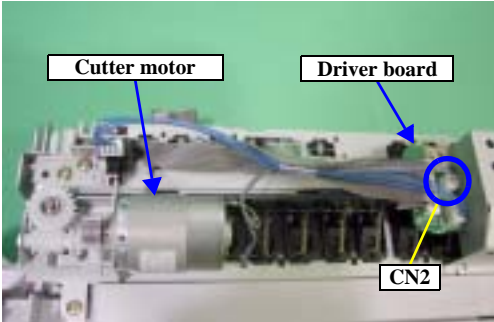
Occurrence Timing	Phenomenon Detail	Faulty Part/ Part Name	Check Point	Remedy
At roll paper feeding by auto loading	After the roll paper is fed, the Paper LED indicates Blink 2.	Cutter motor	<ol style="list-style-type: none"> 1. Check that the connector cable of the Cutter motor is connected to CN2 on the Driver board correctly.  <ol style="list-style-type: none"> 2. Check the Cutter motor for a failure. 3. Check the Cutter motor connector cable for damage. 	<ol style="list-style-type: none"> 1. Connect the connector cable of the Cutter motor to CN2 on the Driver board securely. 2. Change the Cutter motor for a new one. 3. Change the Cutter motor for a new one.
At roll paper feeding	When the roll paper is fed, the Cutter produces operating noise.	Cutter unit	<ol style="list-style-type: none"> 1. Check the rail groove of the Cutter for paper dust, foreign matter, etc. 	<ol style="list-style-type: none"> 1. Remove the paper dust, foreign matter, etc. from the rail groove of the Cutter.
At roll paper cutting	When the roll paper is cut, the paper is cut only halfway.	Cutter unit	<ol style="list-style-type: none"> 1. Check that the paper used is not other than the EPSON special media. 2. Check the Cutter for damage. 	<ol style="list-style-type: none"> 1. Use the EPSON special media. 2. Change the Cutter unit for a new one.

Table 3-15. Phenomenon-Based Cutter Position Error Check Points

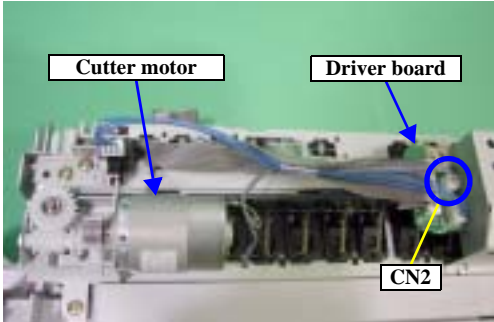
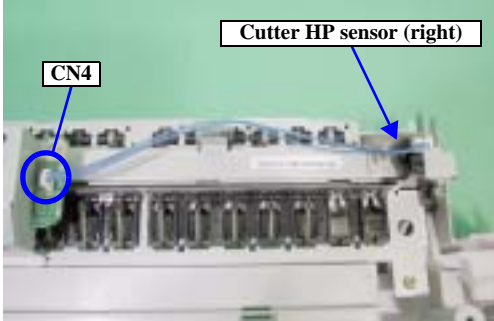
Occurrence Timing	Phenomenon Detail	Faulty Part/Part Name	Check Point	Remedy
<p>At Cutter unit fitting (At power-on)</p>	<p>At power-on, the Carriage produces operating sound instantaneously but the Paper LED indicates Blink 2 immediately.</p>	<p>Cutter motor</p>	<p>1. Check that the Cutter motor connector cable is connected to CN2 on the Driver board correctly.</p>  <p>2. Check the Cutter motor for a failure.</p> <p>3. Check the Cutter motor connector cable for damage.</p> <p>* Above 1 to 3 assume that the Cutter is not in the right HP position.</p>	<p>1. Connect the Cutter motor connector to CN2 on the Driver board securely.</p> <p>2. Change the Cutter motor for a new one.</p> <p>3. Change the Cutter motor for a new one.</p>
<p>At roll paper feeding by auto loading</p>	<p>After the roll paper is fed, the Cutter produces operating noise.</p>	<p>Cutter HP sensor (right)</p>	<p>1. Check the Cutter HP sensor (right) and the rail groove of the Cutter for paper dust, foreign matter, etc.</p>  <p>2. Check that the connector cable of the Cutter HP sensor (right) is connected securely.</p> <p>3. Check the Cutter HP sensor (right) for damage.</p>	<p>1. Remove the paper dust, foreign matter, etc. from the Cutter HP sensor (right) and the rail groove of the Cutter.</p> <p>2. Connect the connector cable of the Cutter HP sensor (right) to CN4 on the Driver board securely.</p> <p>3. Change the Cutter HP sensor (right) for a new one.</p>

Table 3-16. Phenomenon-Based Maintenance Request Check Points

Occurrence Timing	Phenomenon Detail	Faulty Part/Part Name	Check Point	Remedy
At power-on	At power-on, the printer does not operate at all.	Waste ink pads	1. Using the adjustment program, check that the Protection counter A value is 60352 points or more.	1. Change the Waste ink pads and perform panel operation to reset the Protection counter A value (20<H>, 21<H>). Refer to 1.3.6 "Special Setting Mode Function".

Table 3-17. Phenomenon-Based Fatal Error Check Points

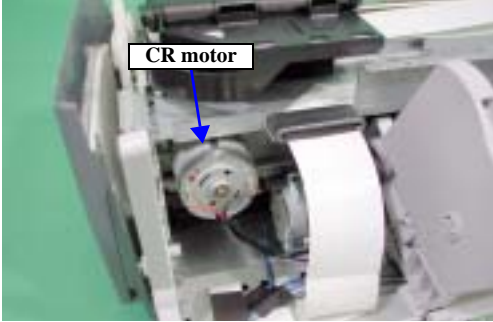
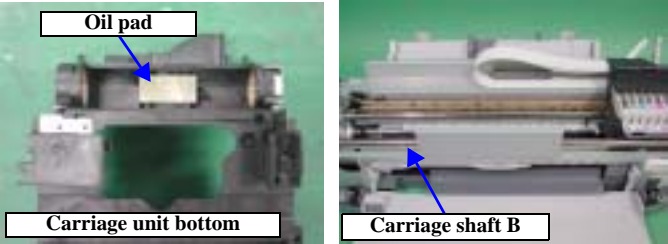
Occurrence Timing	Phenomenon Detail	Faulty Part/Part Name	Check Point	Remedy
At power-on	At power-on, the CR motor does not operate at all.	CR motor	<ol style="list-style-type: none"> 1. Check that the CR motor connector cable is connected to CN17 on the Main board correctly.  <ol style="list-style-type: none"> 2. Using a tester, check that the resistance of the CR motor is $23.0\Omega \pm 5\%$. 3. Check the CR motor connector cable for damage. 	<ol style="list-style-type: none"> 1. Connect the CR motor connector cable to CN17 on the Main board correctly. 2. If the resistance value is abnormal, change the CR motor for a new one. 3. Change the CR motor for a new one.
	The power-on sequence is executed but Fatal error is displayed.	CR drive system	<ol style="list-style-type: none"> 1. Check that the oil of the Oil pad in the CR unit and the grease of the Carriage shaft B are sufficient.  <ol style="list-style-type: none"> 2. Check 6C<H> and 6D<H> of the EEPROM to confirm that 14 is at 6C<H> and 05 is at 6D<H>. 	<ol style="list-style-type: none"> 1. Wipe the surfaces of the CR guide shafts A and B with a dry, soft cloth, and lubricate a new oil pad with O-12 and the Carriage shaft B with grease G-56. 2. If the values are as in Check point 2, change the CR motor for a new one. Alternatively, lubricate as described in above 1 since the CR drive system is overloaded.

Table 3-17. Phenomenon-Based Fatal Error Check Points


Occurrence Timing	Phenomenon Detail	Faulty Part/Part Name	Check Point	Remedy
At power-on	The power-on sequence is executed but Fatal error is displayed.	PF drive system	1. Check B9<H> of the EEPROM to confirm that 79 is at 6C<H>.	1. If the value is as in Check point 2, change the PF motor for a new one.
	At power-on, the PF motor does not operate at all.	PF motor	1. Check that the PF motor connector cable is connected to CN16 on the Main board correctly.  2. Using a tester, check that the resistance of the PF motor is $23.0\Omega \pm 25\%$. 3. Check the PF motor connector cable for damage.	1. Connect the PF motor connector cable to CN16 on the Main board correctly. 2. If the resistance value is abnormal, change the PF motor for a new one. 3. Change the PF motor for a new one.

Table 3-17. Phenomenon-Based Fatal Error Check Points

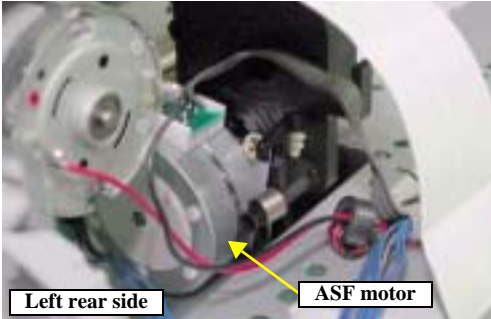
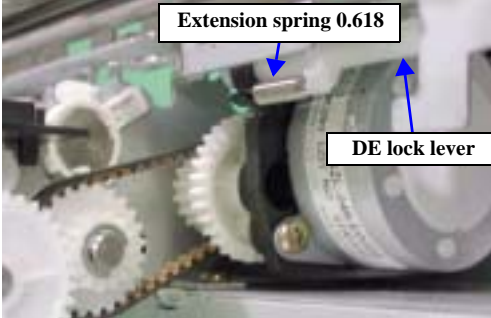
Occurrence Timing	Phenomenon Detail	Faulty Part/Part Name	Check Point	Remedy
At power-on	At power-on, the ASF unit does not operate at all.	ASF motor	<ol style="list-style-type: none"> 1. Check that the ASF motor connector cable is connected to CN8 on the Main board correctly.  <ol style="list-style-type: none"> 2. Using a tester, check that the resistance of the ASF motor is $7.0\Omega \pm 10\%$. (Across Pins 1 and 3 and across Pins 2 and 4, respectively) 3. Check the ASF motor connector cable for damage. 	<ol style="list-style-type: none"> 1. Connect the ASF motor connector cable to CN8 on the Main board correctly. 2. If the resistance value is abnormal, change the ASF motor for a new one. 3. Change the ASF motor for a new one.
At power-on	At power-on, the ASF unit does not operate at all.	Extension spring 0.618	<ol style="list-style-type: none"> 1. Check that the Extension spring 0.618 is mounted between the DE lock lever and DE unit.  <ol style="list-style-type: none"> 2. Check the Extension spring 0.618 for damage. 	<ol style="list-style-type: none"> 1. Install the Extension spring 0.618 between the DE lock lever and DE unit. 2. Change the Extension spring 0.618 for a new one.

Table 3-17. Phenomenon-Based Fatal Error Check Points

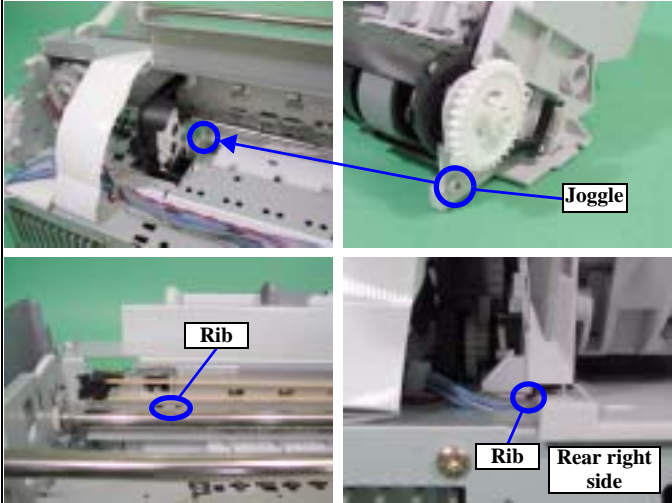
Occurrence Timing	Phenomenon Detail	Faulty Part/Part Name	Check Point	Remedy
<p>At power-on</p>	<p>At power-on, the ASF hopper does not produce operating sound or the ASF hopper makes gearing sound and remains stopped.</p>	<p>ASF unit</p>	<p>1. Check that the two ribs and one joggle of the ASF unit engage with the notches of the Frame.</p>  <p>2. Check that the Hopper has not come off the ASF unit.</p>	<p>1. Reinstall the ASF unit to the printer.</p> <p>2. Install the Hopper correctly.</p>

Table 3-17. Phenomenon-Based Fatal Error Check Points

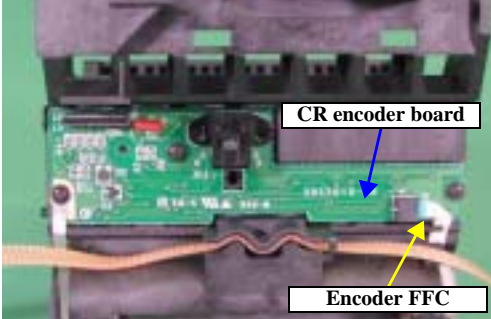
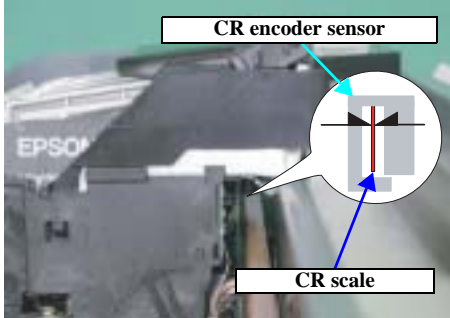
Occurrence Timing	Phenomenon Detail	Faulty Part/Part Name	Check Point	Remedy
<p>At power-on</p>	<p>At power-on, the Carriage moves away from the home position and collides with the right or left of the Frame or stops at the left or right end.</p>	<p>CR encoder board</p>	<ol style="list-style-type: none"> 1. Check that the CR encoder board is mounted to the Carriage correctly (without gap).  <ol style="list-style-type: none"> 2. Check that the Encoder FFC is connected to the CR encoder board. 3. Check the Encoder FFC for damage. 4. Check that the CR scale (Linear encoder) is in the sensor.  <ol style="list-style-type: none"> 5. Check the CR encoder sensor for paper dust, dust, etc. 6. Check the CR encoder board for damage. 	<ol style="list-style-type: none"> 1. Install the CR encoder board to the Carriage correctly. 2. Connect the Encoder FFC to the CR encoder board. 3. Change the Encoder FFC for a new one. 4. Install the CR scale (Linear encoder) in the sensor correctly. 5. Remove the paper dust, dust, etc. from the CR encoder sensor. 6. Change the CR encoder board for a new one.

Table 3-17. Phenomenon-Based Fatal Error Check Points

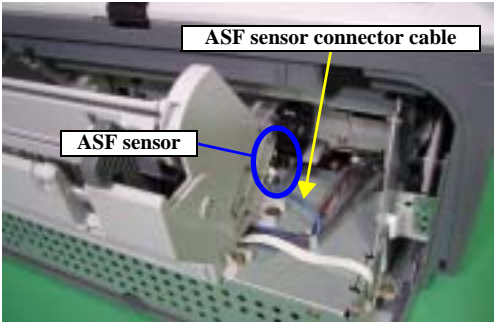
Occurrence Timing	Phenomenon Detail	Faulty Part/Part Name	Check Point	Remedy
At power-on	At power-on, the Carriage moves away from the home position and collides with the right or left of the Frame or stops at the left or right end.	CR scale	1. Check the CR scale (Linear encoder) for damage or contamination.	1. Change the CR scale (Linear encoder) for a new one or clean it completely.
	At power-on, the ASF hopper produces operating noise.	ASF sensor	1. Check that the ASF sensor connector cable is connected to the Sensor and Main board securely.  2. Check the ASF sensor for damage, and turn the ASF sensor wheel manually and check that the voltage across Pins 1 and 2 of CN12 on the Main board is as indicated below with a tester. <ul style="list-style-type: none"> • Home : 0.4V or less • Other than home : 2.4V or more 	1. Connect the ASF sensor connector cable to the Sensor and Main board securely. 2. If the voltage value is abnormal, change the ASF sensor for a new one.

Table 3-17. Phenomenon-Based Fatal Error Check Points

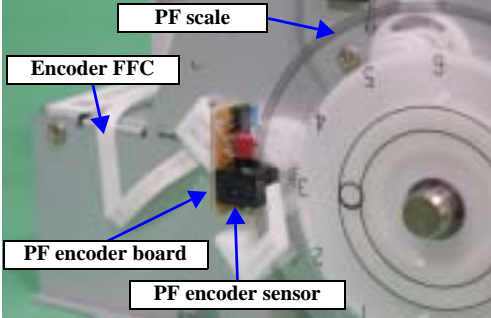
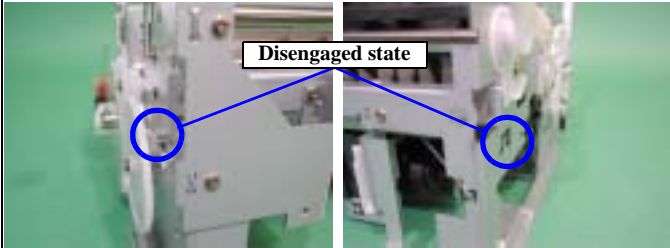
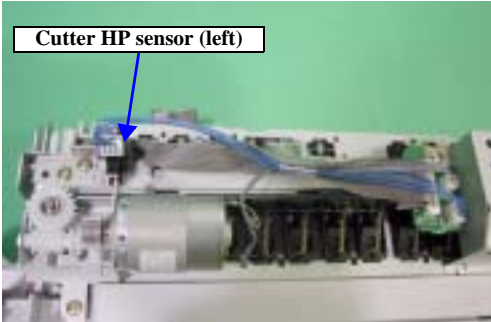
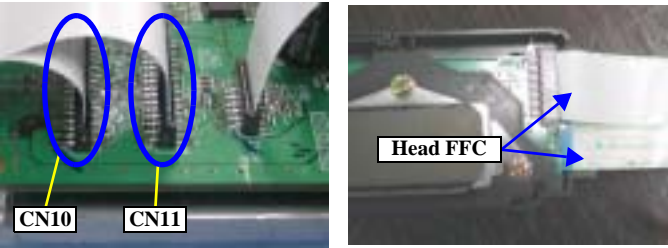
Occurrence Timing	Phenomenon Detail	Faulty Part/Part Name	Check Point	Remedy
<p>At power-on</p>	<p>At power-on, the PF roller rotates fast about a half turn. The ASF hopper makes operating noise.</p>	<p>PF encoder</p>	<ol style="list-style-type: none"> 1. Check that the PF encoder board is mounted correctly.  <ol style="list-style-type: none"> 2. Check that the Encoder FFC is connected to the PF encoder board and Main board. 3. Check that the PF scale (Rotary encoder) is in the sensor. 4. Check the PF encoder sensor for paper dust, dust, etc. 5. Check the PF encoder board for damage. 6. Check the Encoder FFC for damage. 	<ol style="list-style-type: none"> 1. Install the PF encoder board correctly. 2. Connect the Encoder FFC to the PF encoder board and Main board. 3. Install the PF scale (Rotary encoder) in the sensor correctly. 4. Remove paper dust, dust, etc. from the PF encoder sensor. 5. Change the PF encoder board for a new one. 6. Change the Encoder FFC for a new one.
	<p>PF scale</p>	<ol style="list-style-type: none"> 1. Check the PF scale (Rotary encoder) for damage or contamination. 	<ol style="list-style-type: none"> 1. Change the PF scale (Rotary encoder) for a new one. 	
	<p>At power-on, the Carriage does not move.</p>	<p>Paper eject unit</p>	<ol style="list-style-type: none"> 1. Check that the left and right fitting portions of the Paper eject unit have not come out of the left and right Frames and collided with the Carriage. 	<ol style="list-style-type: none"> 1. Fit the left and right fitting portions of the Paper eject unit to the left and right Frames correctly.

Table 3-17. Phenomenon-Based Fatal Error Check Points

Occurrence Timing	Phenomenon Detail	Faulty Part/Part Name	Check Point	Remedy
<p>At power-on (At Cutter unit fitting)</p>	<p>In Cutter initialization operation, the Carriage produces operating noise at power-on.</p>	<p>Cutter HP sensor (left)</p>	<p>1. Check the Cutter HP sensor (left) and the rail groove of the Cutter for paper dust, foreign matter, etc.</p>  <p>2. Check that the connector cable of the Cutter HP sensor (left) is connected securely</p> <p>3. Check the Cutter HP sensor (left) for damage.</p> <p>* The above check points 1 to 3 apply to the case where the Cutter is not in the right HP position.</p>	<p>1. Remove the paper dust, foreign matter, etc. from the Cutter HP sensor (left) and the rail groove of the Cutter.</p> <p>2. Connect the connector cable of the Cutter HP sensor (left) to CN3 on the Driver board securely.</p> <p>3. Change the Cutter HP sensor (left) for a new one.</p>
<p>During printing</p>	<p>Before start of printing, initial filling is executed and printing is then started. Ink is not delivered and paper stops midway.</p>	<p>Head FFC</p>	<p>1. Check that the Head FFC is connected to the Printhead and Main board.</p>  <p>2. Check the Head FFC for damage.</p>	<p>1. Connect the Head FFC to the Printhead and Main board correctly.</p> <p>2. Change the Head FFC for a new one.</p>
	<p>Ink is not delivered from most nozzles.</p>	<p>Printhead</p>	<p>1. Check for occurrence of Head Hot.</p>	<p>1. Change the Printhead for a new one.</p>

3.3.1 Superficial Phenomenon-Based Troubleshooting

This section applies to the fault locations of the error states (print quality fault and abnormal noise) other than the error states (LED and EPW3) in the previous section.

Table 3-18. Print Quality Fault Check Points

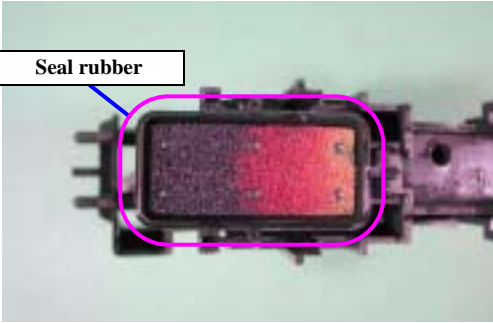
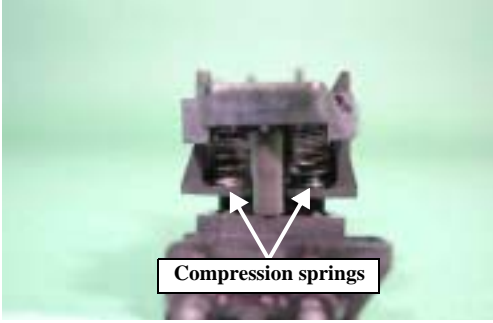
Print Quality State	Phenomenon Detail	Faulty Part/ Part Name	Check Point	Remedy
<p>Dot missing and mixed colors</p>	<p>[Phenomenon 1] In the CL sequence, the Pump unit operates properly but ink is not ejected to the Waste ink pads. Ink is not sucked from the Printhead into the Cap at all. Hence, printing is not executed if a print command is given to the printer. (Dot missing)</p>	<p>Cap unit</p>	<p>1. Check for foreign matter around the Seal rubber on the Cap unit.</p>  <p>2. Check that the Compression springs are assembled correctly in the Cap unit.</p> 	<p>1. Remove foreign matter around the Seal rubber carefully.</p> <p>2. Install the Compression springs to the Cap unit correctly.</p>

Table 3-18. Print Quality Fault Check Points

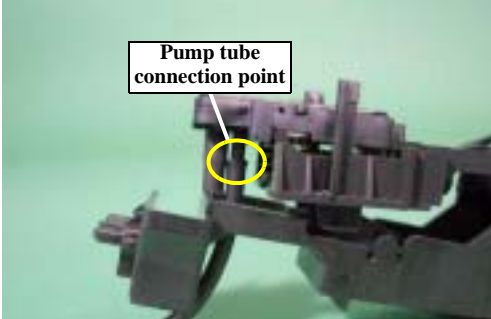
Print Quality State	Phenomenon Detail	Faulty Part/ Part Name	Check Point	Remedy
Dot missing and mixed colors (Continued)	[Phenomenon 1] (Continued) In the CL sequence, the Pump unit operates properly but ink is not ejected to the Waste ink pads. Ink is not sucked from the Printhead into the Cap at all. Hence, printing is not executed if a print command is given to the printer. (Dot missing)	Cap unit	3. Check that the Ink tube is connected to the bottom of the Cap unit correctly. 	3. Connect the Ink tube correctly
	[Phenomenon 2] In the CL sequence, ink is ejected to the Waste ink pads. However, Dot missing/displacement occurs in all nozzles during printing and this problem is not resolved after several times of CL. (Dot missing)	Printhead	1. Check that each segment is printed correctly in the nozzle check pattern 2. Check the connection states of both Connectors CN10, CN11 of the Head FFC. 3. Check the Head FFC for damage.	1. Perform Printhead cleaning and check the nozzle check pattern. 2. Connect both Connectors CN10, CN11 of the Head FFC correctly. 3. Change the Head FFC for a new one. If the problem still persists, change the Printhead for a new one.
		Main board	1. Check the Main board for a failure.	1. Change the Main board for a new one.

Table 3-18. Print Quality Fault Check Points

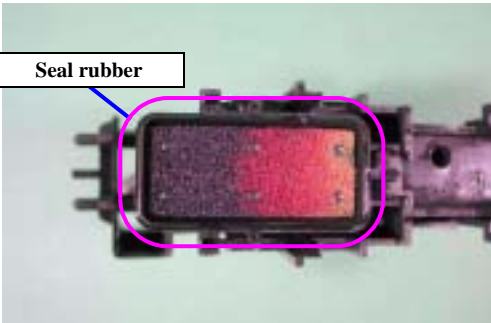
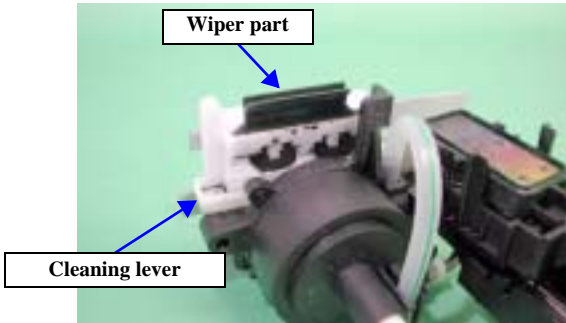
Print Quality State	Phenomenon Detail	Faulty Part/ Part Name	Check Point	Remedy
<p>Dot missing and mixed colors (Continued)</p>	<p>[Phenomenon 3] In the CL sequence, ink is ejected to the Waste ink pads. (This means that the Pump unit and Cap unit operate properly.) However, Dot missing is not resolved in indefinite nozzles after CL has been executed several times. (Dot missing/mixed colors)</p> <p>[Phenomenon 4] In the CL sequence, ink is ejected to the Waste ink pads. However, drawing operation is not performed properly, resulting in mixture of colors. (Mixed colors)</p>	<p>Cap unit</p>	<ol style="list-style-type: none"> 1. Check for damage around the Seal rubber on the Cap unit.  <ol style="list-style-type: none"> 2. Check that the Wiper part is mounted on the Cleaning lever correctly. 	<ol style="list-style-type: none"> 1. Change the Cap unit for a new one. 2. Install the Wiper part correctly or change it for a new one.
		<p>Ink cartridge</p>	<ol style="list-style-type: none"> 1. Look at the remaining ink indication of the EPW3 to check for the ink remaining in the Ink cartridge. 	<ol style="list-style-type: none"> 1. Change the Ink cartridge for a new one.

Table 3-18. Print Quality Fault Check Points

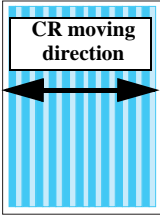
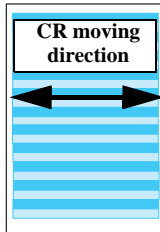
Print Quality State	Phenomenon Detail	Faulty Part/ Part Name	Check Point	Remedy	
White streak/color unevenness occurrence	Vertical stripes appear relative to the CR moving direction and printing is uneven.  * If the problem is not solved, change the CR motor for a new one.	CR unit	1. Check the surfaces of the CR guide shafts for foreign matter. 2. Check the surfaces of the CR guide shafts for damage. 3. Check that the oil of the Oil pad in the CR unit and the grease of the Carriage shaft B are sufficient. 4. Check that the CR guide shafts are mounted horizontally.	1. Remove foreign matter from the CR guide shafts. 2. Change the CR guide shafts for new ones. 3. Wipe the surfaces of the CR guide shafts A and B with a dry, soft cloth, and lubricate a new Oil pad with O-12 and the Carriage shaft B with grease G-56. 4. Reassemble the CR guide shafts correctly.	
		Printhead	1. Check that each segment is printed correctly in the nozzle check pattern.	1. Perform Head cleaning and check the nozzle check pattern. If the problem is not solved, change the Printhead for a new one.	
		Adjustment	1. If the printing pattern is 2850dpi, check that the pixel shift adjustment is made properly.	1. Perform pixel shift adjustment to make correction so that the print timings (PZT response speeds) of the color nozzle lines are the same. Select the pattern that has the fewest displacements between the rules.	
	1. For printing in the Bi-D mode, check that the Bi-D adjustment has been performed properly.		1. Perform Bi-D adjustment to eliminate displacements between the upper and lower rules.		
	Narrow stripes of the same width appear horizontally relative to the CR moving direction.	 * If the problem is not solved, change the PF motor for a new one.	PF roller	1. Check the surface of the PF roller for foreign matter. 2. Check the Spur gear 76 for damage. 3. Check the PF roller for damage.	1. Clean the PF roller surface carefully. 2. Change the Spur gear 76 for a new one. 3. Change the PF roller for a new one.
			Printer driver and exclusive paper	1. Check that adequate paper is used according to the setting of the printer driver.	1. Use adequate paper according to the setting of the printer driver.
Printhead			1. Check that each segment is printed correctly in the nozzle check pattern.	1. Perform Head cleaning and check the nozzle check pattern. If the problem is not solved, change the Printhead for a new one.	

Table 3-18. Print Quality Fault Check Points

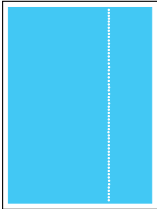
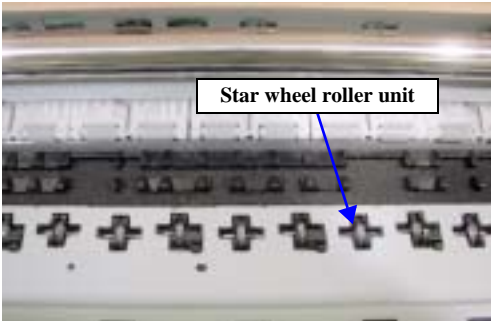
Print Quality State	Phenomenon Detail	Faulty Part/ Part Name	Check Point	Remedy
White streak/color unevenness occurrence	White streaks/color unevenness occurs horizontally in a fixed cycle (at fixed intervals of about 4.5mm) during 360dpi printing.	Adjustment	<ol style="list-style-type: none"> 1. Check for Dot missing. 2. Check that PF adjustment is executed properly. 	<ol style="list-style-type: none"> 1. Change the Cap unit for a new one. 2. Perform PF adjustment properly.
White streak/color unevenness occurrence (Continued)	Star wheel roller traces appear relative to the CR moving direction. 	Paper eject unit	<ol style="list-style-type: none"> 1. Check that the Star wheel roller unit has not come off or rotates. 	<ol style="list-style-type: none"> 1. Reassemble the Star wheel roller unit correctly.
	Printing is executed securely but blur occurs.	Printer driver and exclusive paper	<ol style="list-style-type: none"> 1. Check that adequate paper is used according to the setting of the printer driver. 	<ol style="list-style-type: none"> 1. Use adequate paper according to the setting of the printer driver.
		Printhead	<ol style="list-style-type: none"> 1. Using the adjustment program, check that the correct head ID has been written to the EEPROM. 	<ol style="list-style-type: none"> 1. Using the adjustment program, enter the 25-digit code of the head ID to the EEPROM.
Occurrence of Paper eject roller traces	Paper eject roller traces occur during printing of print paper or CD-R. (Only for Stylus PHOTO 2100)	Printer driver and exclusive paper	<ol style="list-style-type: none"> 1. Check that adequate paper is used according to the setting of the printer driver. 2. Check that the print color correction setting for EPSON CD Direct Print 2 is not the positive side setting. (Only for Stylus PHOTO 2100) 	<ol style="list-style-type: none"> 1. Use adequate paper according to the setting of the printer driver. 2. Set the print color correction setting to ± 0. (Only for Stylus PHOTO 2100)

Table 3-18. Print Quality Fault Check Points

Print Quality State	Phenomenon Detail	Faulty Part/ Part Name	Check Point	Remedy
Ink stain of paper	Ink stain occurs at the back or end of the print paper.	Front paper guide ink pads	1. Check that heaps of ink are not formed on the Ink pads and that the Ink pads are installed securely and evenly in the setting position.	1. If heaps of ink are formed, replace the Ink pads. At this time, if the ink has solidified in the Ink pad setting section of the Front paper guide, it can cause the Ink pads to rise. After removing the ink, therefore, install new Ink pads. If it has been confirmed that the Ink pads have risen, reinstall the Ink pads correctly.
	Ink sticks to other than the print area of the paper, resulting in contamination.	Paper eject unit	1. Check the Star wheel rollers for ink stain.	1. Clean the Star wheel rollers with a soft cloth.
		Front paper guide	1. Check the Front paper guide for ink stain.	1. Clean the Front paper guide with a soft cloth carefully.
		Front paper guide (Ink pads)	1. Check for the formation of ink heaps.	1. Change the Front paper guide (Ink pads) for a new one.

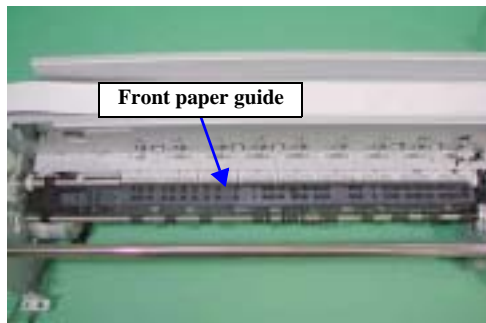


Table 3-18. Print Quality Fault Check Points

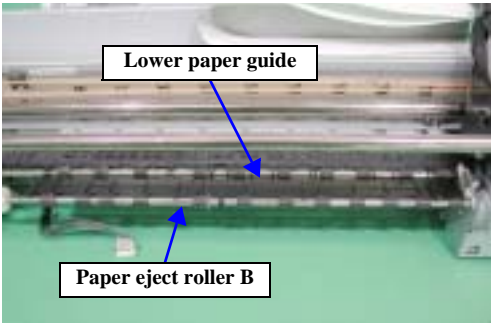
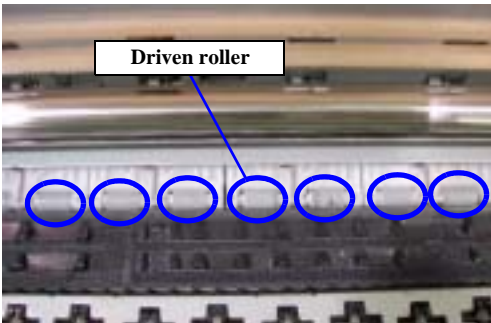
Print Quality State	Phenomenon Detail	Faulty Part/ Part Name	Check Point	Remedy
Ink stain of paper	Ink sticks to other than the print area of the paper, resulting in contamination.	Paper eject roller B	1. Check the Paper eject roller B for ink stain. 	1. Clean the Paper eject roller B with a soft cloth carefully. Alternatively, execute the Roller cleaning mode.
		Lower paper guide	1. Check the Lower paper guide for ink stain.	1. Clean the Lower paper guide with a soft cloth carefully.
Ink stain of paper	Ink sticks to other than the print area of the paper, resulting in contamination.	Frame (Upper)	1. Check the Driven rollers for ink stain. 	1. Clean the Driven rollers with a soft cloth.

Table 3-18. Print Quality Fault Check Points

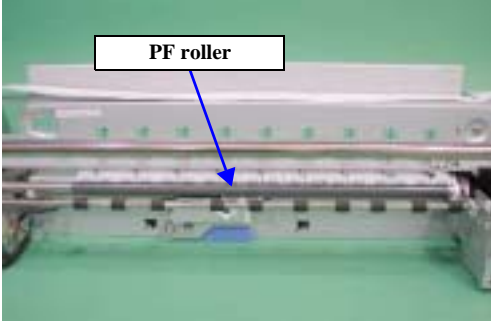
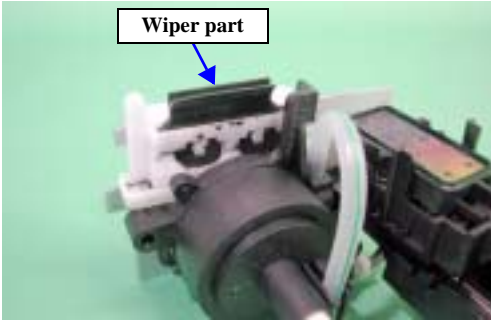
Print Quality State	Phenomenon Detail	Faulty Part/ Part Name	Check Point	Remedy
Ink stain of paper	Ink sticks to other than the print area of the paper, resulting in contamination.	PF roller	1. Check the PF roller for ink stain. 	1. Clean the PF roller with a soft cloth carefully
	Ink sticks to other than the print area of the paper, resulting in contamination.	Ink unit	1. Check that wiping operation was performed properly. 	1. Install the Wiper blade correctly or change it for a new one.

Table 3-18. Print Quality Fault Check Points

Print Quality State	Phenomenon Detail	Faulty Part/ Part Name	Check Point	Remedy
Image graininess	The image graininess is poor in all print modes or the image looks rough.	Improper adjustment, Main board or Head	1. Check that PG, Bi-D and Head tilt adjustments have been made properly.	1. Make adjustments according to the specified adjustment priority. 2. If Bi-D displacements occur after the above adjustments have been made according to the specified adjustment priority, replace the Main board.
	The image graininess is poor only in the 2880dpi print modes or the image looks rough.		1. After making sure that PG, Bi-D and Head tilt adjustments have been made correctly, check whether pixel shift adjustment has been performed properly.	1. Make adjustments according to the specified adjustment priority. 2. If the graininess of the image is not improved after the above adjustments have been made according to the specified adjustment priority, replace the Head and Main board in this order and then check the image graininess.
Color of image	The whole image is reddish.	Improper adjustment or Head	1. Check that the PG adjustment value is proper. 2. Check that Bi-D and Head tilt and Pixel shift adjustments have been made properly.	1. Make adjustments according to the specified adjustment priority. 2. Make adjustments according to the specified adjustment priority. 3. If the color of the image does not change after the adjustments have been made, replace the Head. Alternatively, recommend the user to use the printer with the Release lever placed in the envelope mode position.
No Margines Printing	No Margine printing can not be performed with the No margine printing.	Paper powder// PG lever operation / PW seonsor failure	1. Check if the paper powder or scrap of the paper is on the paper guide front. 2. Was the Release lever position changed from + position to normal position after tunr on the printer? 3. Compare the PW detect level stored in the 76 <H> address the PW White level stored in BB<H> . If the difference of those data is a little or 76<H> address data is lower than BB<H> data, the PW sensor may be broken.	1. Remove the paper powder or scrap of the paper. 2. Tunn on /off the printer again. 3. Replace the PW sensor.

Table 3-19. Phenomenon-Based Abnormal Noise Check Points

Occurrence Timing	Phenomenon Detail	Faulty Part/Part Name	Check Point	Remedy
-	Printing operation is performed normally but abnormal noise is produced at power-on or between operations.	CR unit	1. Check that oil is fully applied on the CR guide shaft A.	1. Wipe the oil applied on the CR guide shaft A, change the Oil pad for a new one, and apply oil.

3.4 EEPROM Data Analysis

T.B.D

CHAPTER

4

DISASSEMBLY AND ASSEMBLY

4.1 Overview

This chapter describes procedures for disassembling and assembling this product. Unless otherwise specified, the disassembled units or main components can be reassembled by reversing the disassembling procedure.

- **Warning**
Procedures that could result in injury or loss of life, if cautions are not taken, are described under the heading "WARNING".
- **Caution**
Precautions for any disassembly or assembly procedures are described under the heading "CAUTION".
- **Check Point**
Tips for disassembling procedures are described under the heading "CHECK POINT".
- **Reassembly**
If the assembling procedure is different from the reverse procedure of disassembling, it is described under the heading "REASSEMBLY".
- **Adjust**
Any adjustments required after disassembling or assembling are described under the heading "ADJUST".

When you need to disassemble any units or parts that are not described in this chapter, refer to the exploded diagrams in the Appendix.

Before starting your work, always read the precautions described in the next section.

4.1.1 Precautions

Before starting the disassembling/reassembling work of this product, always read the descriptions under the following headings "WARNING" and "CAUTION" carefully.



- **Before starting the disassembling/reassembling work of this product, always disconnect the power cable. However, if you cannot disconnect the power cable for voltage measurement or like, be extremely careful not to get an electric shock and follow the procedures in this manual to do your work.**
- **Always wear goggles to protect your eyes from ink. If ink gets in your eyes, wash your eyes with clean water and see the doctor.**
- **To prevent injury from sharp metal edges, always wear gloves for disassembly and reassembly.**
- **If ink has adhered to your skin, wash it with soap and water. If it has caused skin irritation, see the doctor.**
- **To protect the microprocessors and circuitry, use static discharge equipment, such as anti-static wrist straps, and handle them carefully when accessing the internal components.**



- **Avant de commencer, assurez vous que l'imprimante soit éteinte et que le cordon d'alimentation soit débranché.**
- **Veillez à jeter les piles usagées selon le règlement local.**



- When the printer model uses the HAV ink cartridges, transport it after removing the ink cartridges. Especially for air transportation, always remove the ink cartridges before transportation since ink will flow into the cap via the head with the reduction of the atmospheric pressure, causing ink leakage.
- Use only the recommended tools for disassembly, reassembly and adjustment. (Refer to Table 4-1 "Tool List".)
- Tighten screws to the specified torques.
- Use the specified lubricants and adhesives. (Refer to Chapter 6 "Maintenance".)
- Make the necessary adjustments under the instructions given for disassembling. (Refer to Chapter 5 "Adjustment".)
- When reassembling the waste ink pads and tray, always make sure that the waste ink tube is fitted correctly in the specified place. Fitting the ink tube in other than the specified position can cause ink leakage.

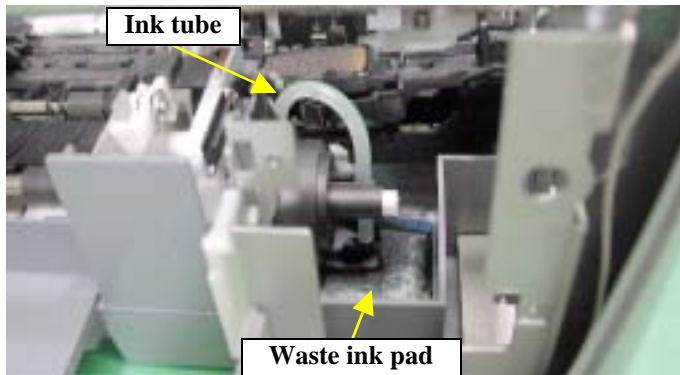


Figure 4-1. Position Specified for Ink Tube

4.1.2 Tools to Be Used

The following table indicates the tools recommended for use for disassembly, reassembly and adjustment.

Table 4-1. Tool List

Tool Name	Supplier	Code
Scale PF unit applying jig	EPSON	1051767
Mounting plate scale jig	EPSON	1051765
Phillips Screw Driver (No.1)	○	B743800400
Phillips Screw Driver (No.2)	○	B743800200
Tweezers	○	B741000100
PG adjustment gauge set	EPSON	1113311
Nippers	○	B7405001

NOTE: ○:Available

4.1.3 Screw List

The following table lists the screws used in this product. When disassembling and reassembling the printer, refer to the following table and use the specified screws in the specified positions. The screw numbers given in this manual correspond to the screw numbers in this table.

Table 4-2. Used Screw List







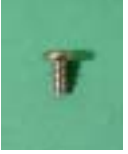




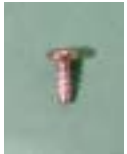

Appearance	Specifications	Appearance	Specifications
	screw 1) C.B.S 3×14		screw 2) C.B.S 3×10
	screw 3) C.B.P 3×14		screw 4) C.B.P 4×12
	screw 5) C.B.P 3×10		screw 6) C.B.S 3×6
	screw 7) C.P 3×6		screw 8) C.B.P 3×6
	screw 9) C.B.S (P4) 3×6		screw 10) CR mount shaft
	screw 11) C.B.P 2.5×5		screw 12) C.P.B (P1) 1.7×5

Table 4-2. Used Screw List

Appearance	Specifications	Appearance	Specifications
	screw 13) C.P.S 3×6		screw 14) C.B.P 3×8
	screw 15) C.B.S 3×8		screw 16) C.P 2.5×3

4.1.4 Pre-shipment Checks

- When returning this product to the user after completion of printer repair, check that the work is complete using the following table.

Table 4-3. Servicing Completion Pre-shipment Check List

Class	Component	Check Item	Check Field
Main Unit	Self-test	Is the operation normal?	<input type="checkbox"/> Checked / <input type="checkbox"/> Not necessary
	On-line Test	Is the printing successful?	<input type="checkbox"/> Checked / <input type="checkbox"/> Not necessary
	Printhead	Is ink discharged normally from all the nozzles	<input type="checkbox"/> Checked / <input type="checkbox"/> Not necessary
	Carriage Mechanism	Does it move smoothly?	<input type="checkbox"/> Checked / <input type="checkbox"/> Not necessary
		Is there any abnormal noise during its operation?	<input type="checkbox"/> Checked / <input type="checkbox"/> Not necessary
		Is there any dirt or foreign objects on the CR Guide Shaft?	<input type="checkbox"/> Checked / <input type="checkbox"/> Not necessary
		Is the CR Motor at the correct temperature?	<input type="checkbox"/> Checked / <input type="checkbox"/> Not necessary
	Paper Feeding Mechanism	Is paper advanced smoothly?	<input type="checkbox"/> Checked / <input type="checkbox"/> Not necessary
		No paper jamming?	<input type="checkbox"/> Checked / <input type="checkbox"/> Not necessary
		No paper skew?	<input type="checkbox"/> Checked / <input type="checkbox"/> Not necessary
		No multiple feeding?	<input type="checkbox"/> Checked / <input type="checkbox"/> Not necessary
		No abnormal noise?	<input type="checkbox"/> Checked / <input type="checkbox"/> Not necessary
		Is the PF Motor at correct temperature?	<input type="checkbox"/> Checked / <input type="checkbox"/> Not necessary
Is the paper path free of any obstructions?		<input type="checkbox"/> Checked / <input type="checkbox"/> Not necessary	
Adjustment	Specified Adjustment	Are all the adjustment done correctly?	<input type="checkbox"/> Checked / <input type="checkbox"/> Not necessary
Lubrication	Specified Lubrication	Are all the lubrication made at the specified points?	<input type="checkbox"/> Checked / <input type="checkbox"/> Not necessary
		Is the amount of lubrication correct?	<input type="checkbox"/> Checked / <input type="checkbox"/> Not necessary
Function	ROM Version	Version: _____	<input type="checkbox"/> Checked / <input type="checkbox"/> Not necessary
Packing	Ink Cartridge	Have the ink cartridges been removed?	<input type="checkbox"/> Checked / <input type="checkbox"/> Not necessary
	Protective Materials	Have all relevant protective materials been attached to the printer?	<input type="checkbox"/> Checked / <input type="checkbox"/> Not necessary
Others	CD-R tray	Is the operation normal?	<input type="checkbox"/> Checked / <input type="checkbox"/> Not necessary
	Cutter unit	Is the operation normal?	<input type="checkbox"/> Checked / <input type="checkbox"/> Not necessary
	Attachments, Accessories	Have all the relevant items been included in the package?	<input type="checkbox"/> Checked / <input type="checkbox"/> Not necessary

4.2 Disassembly

□ Follow the flowchart shown below to proceed with disassembling procedures. When disassembling any unit, refer to the page number shown in the following flowchart.

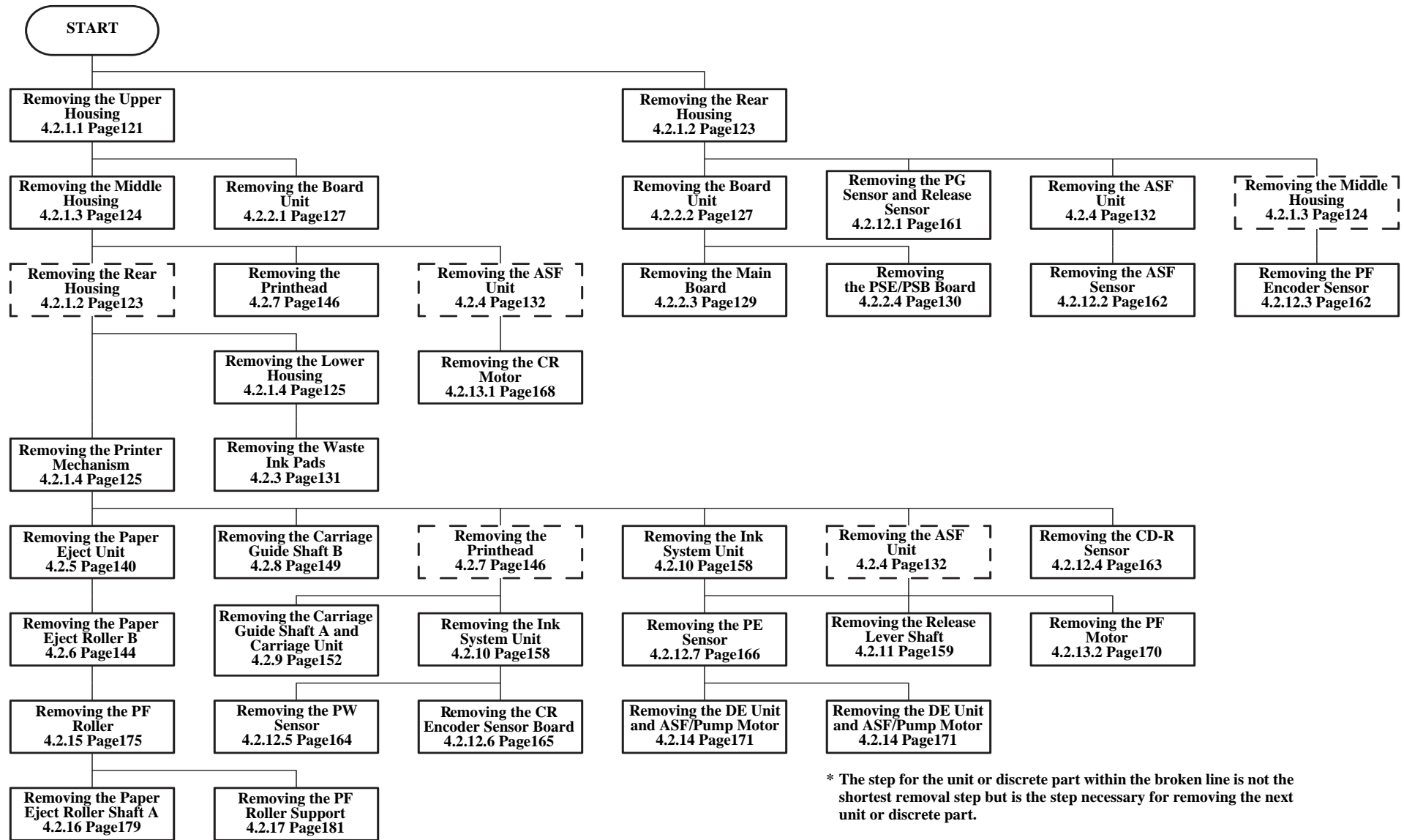


Figure 4-2. Disassembling Procedure Flowchart

4.2.1 Removing the Housings

4.2.1.1 Removing the Upper Housing

1. Open the Printer Cover and Stacker.
2. Remove the two clips, which are fitted in the front of the Upper Housing as viewed from the printer front, by inserting a flat-blade screwdriver into the clip gaps.
3. Remove the four screws 1) C.B.S 3×14 (9±1kgf.cm) that secure the Upper Housing.

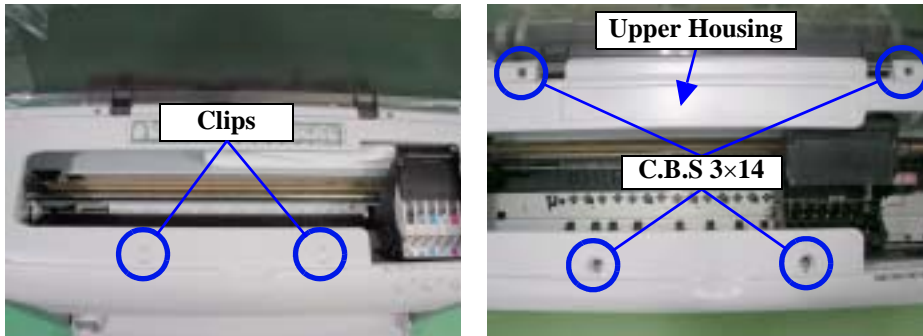


Figure 4-3. Screws That Secure the Upper Housing

4. Release a total of six cutouts, which secure the Upper Housing, from the hooks of the Middle Housing.

The left and right cutouts of the Upper Housing can be released easily by pushing them from inside the printer. To release the right-hand side cutouts, however, the CR Lock Lever must be moved to the front position, as viewed from the printer front, using tweezers or like and the CR Unit moved to near the printer center.



Fully be careful when handling the two cutouts on the left/right of the Upper Housing, as viewed from the printer front, since they are easily broken.

Refer to Figure 4-4, "Hooks That Secure the Left and Right of the Upper Housing".

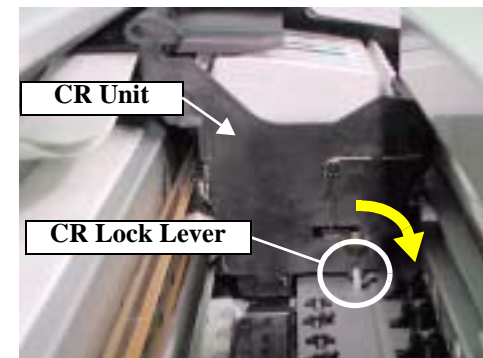
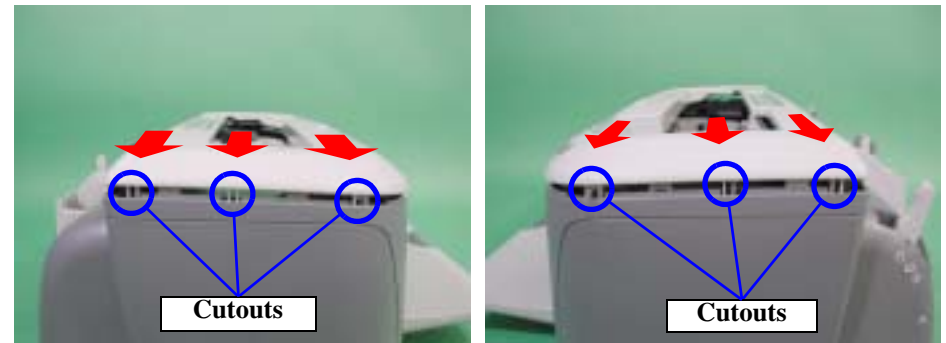


Figure 4-4. Hooks That Secure the Left and Right of the Upper Housing

5. Pull the two hooks, which secure the Upper Housing and are located at bottom front as viewed from the printer front, to the front and lift them up to release.

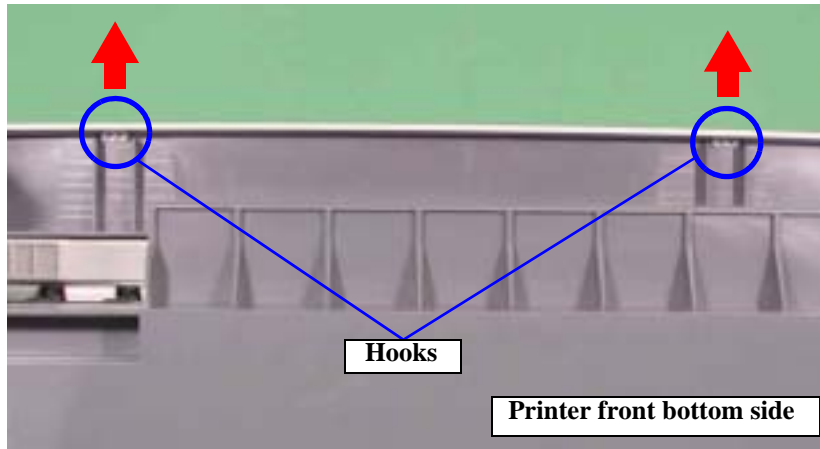


Figure 4-5. Hooks That Secure the Bottom Front of the Upper Housing

6. Slightly lift the Upper Housing, remove the FFC from the connector of the Panel Board that is located on the bottom front right side of the Upper Housing as viewed from the printer front, and remove the Upper Housing.

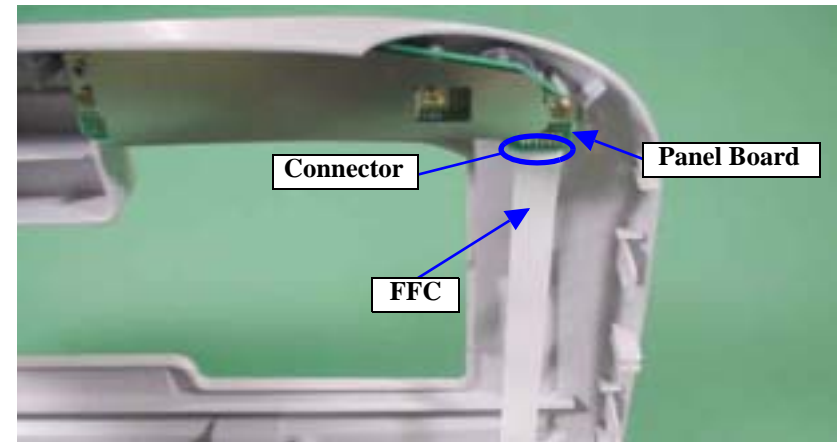


Figure 4-6. Removing the FFC



Insert the FFC into the Panel Board connector securely. Refer to Figure 4-6, "Removing the FFC".

4.2.1.2 Removing the Rear Housing

1. Remove the three screws 2) C.B.S 3×10 (9±1kgf.cm) that secure the Rear Housing.

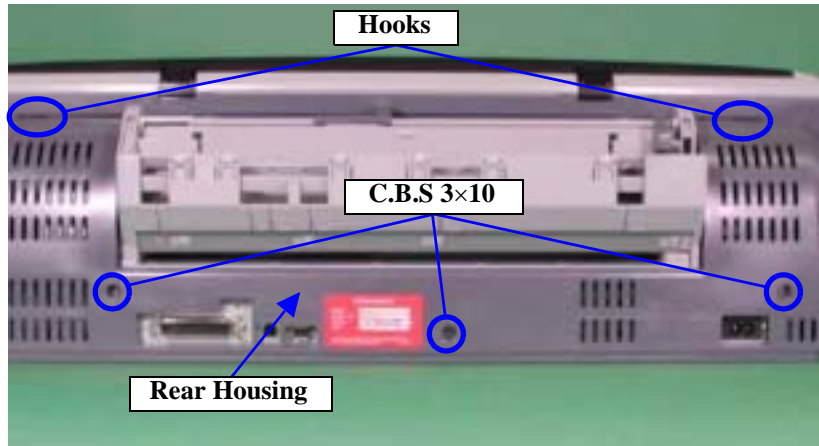


Figure 4-7. Screws That Secure the Rear Housing

2. Lower the Release Lever in advance. While pulling down the three cutouts, which secure the bottom of the Rear Housing as seen from the printer rear, one by one, release them from the Rear Housing. Push the two hooks, which secure the left and right, one by one toward the printer inside to pull them out of the Lower Housing, and remove the Rear Housing from the printer using the two upper hooks as supports.



Fully take care when releasing the three lower cutouts since they whiten easily. Especially as the cutout on the bottom left side as viewed from the printer rear whitens more easily than the others. The recommended disassembling procedures are as follows.

- Remove the right side hook figured on 2 in the Figure4-8 by pushing the blue circled portion strongly. Then remove the right bottom (red circled portion on 2 in the Figure4-8).
- Then, remove the right side of the Rear housing and remove the center bottom cutout carefully.
- After that, while pulling the Rear housing downward, remove the left side hook figured on 1 in the Figure4-8 by pushing the blue circled portion strongly. By pulling the Rear housing downward, the left bottom cutout portion is easily released from the bottom housing.

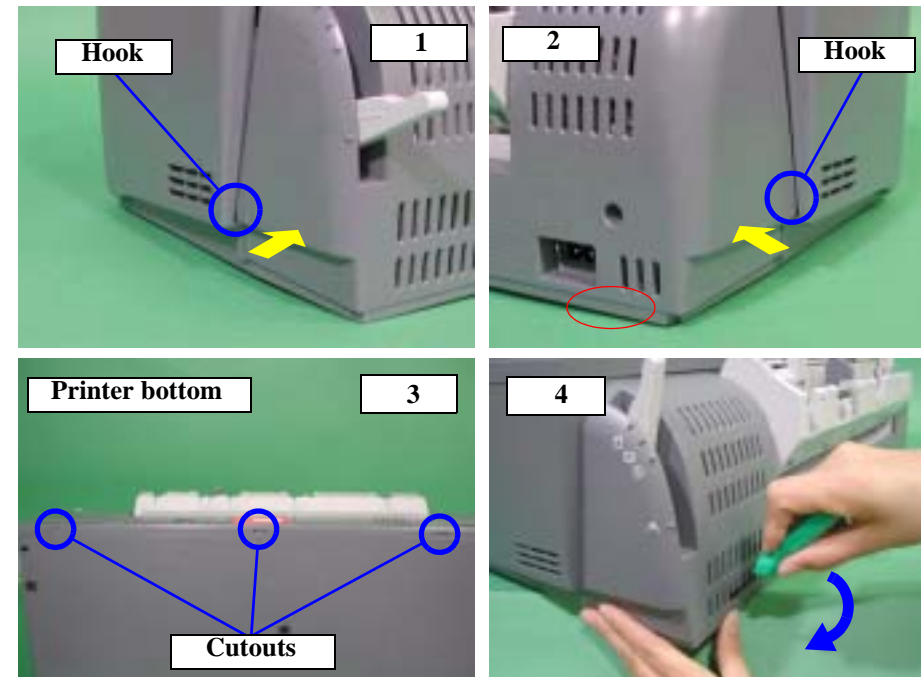


Figure 4-8. Hooks and Cutouts That Secure the Rear Housing



An easy way to reinstall the Rear Housing is to insert the upper hooks of the Rear Housing into the Middle Housing, mount the Rear Housing using the two upper hooks as supports, and fit the cutouts of the Rear Housing into the lower hooks of the Lower Housing.

Refer to Figure 4-8, "Hooks and Cutouts That Secure the Rear Housing".

4.2.1.3 Removing the Middle Housing

1. Remove the Upper Housing. (Refer to 4.2.1.1.)
2. Remove the two screws 3) C.B.P 3×14 (6±1kgf.cm), which secure the Middle Housing, from the Middle Housing.

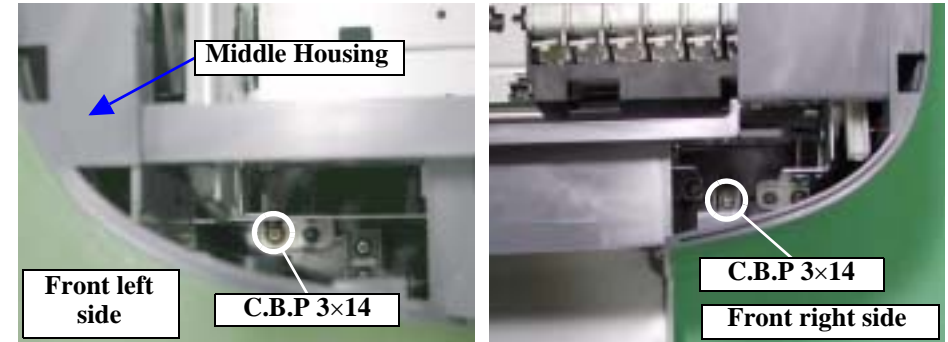


Figure 4-9. Screws That Secure the Middle Housing

3. Release the six hooks, which secure the left and right of the Middle Housing, from the Lower Housing, and while turning the Middle Housing rearward as viewed from the printer front, lift it to remove.
By pushing the cutouts of the Lower Housing toward the printer inside one by one to disengage them from the hooks of the Middle Housing, you can release the hooks easily.

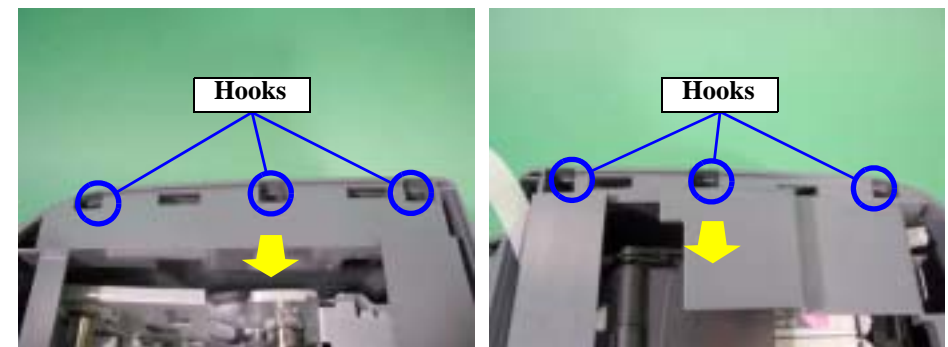


Figure 4-10. Hooks That Secure the Left and Right of the Middle Housing

CAUTION

When removing the Middle Housing, fully push the hooks of the Middle Housing into the printer inside to release the hooks since the six cutouts of the Lower Housing are broken easily. Refer to Figure 4-10, "Hooks That Secure the Left and Right of the Middle Housing".

4.2.1.4 Removing the Printer Mechanism/Lower Housing

1. Remove the Rear Housing. (Refer to 4.2.1.2.)
2. Remove the Middle Housing. (Refer to 4.2.1.3.)
3. Remove the one screw 2) C.B.S 3×10 (9±1kgf.cm) and four screws 4) C.B.P 4×12 (9±1kgf.cm) that secure the Printer Mechanism.

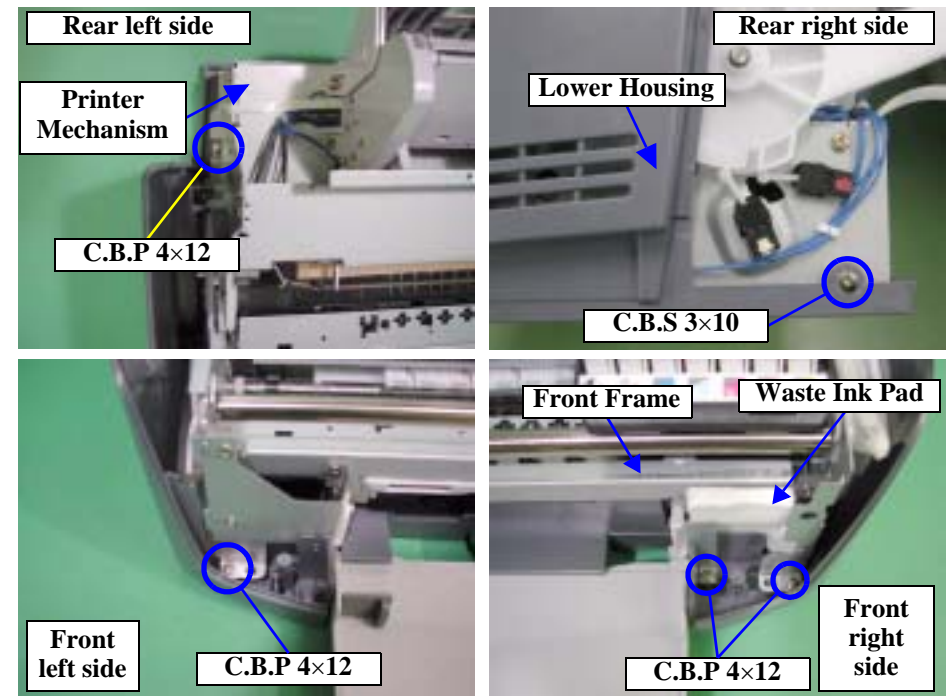


Figure 4-11. Screws That Secure the Printer Mechanism

REASSEMBLY

Fit the screws 4) C.B.P 4×12 (9±1kgf.cm) in the order shown in Figure 4-11. (T.B.D.)

4. Peel the Waste Ink Pad on the front right side, as viewed from the printer front, from the Front Frame.

CAUTION

Fully be careful when removing the Printer Mechanism after peeling the Waste Ink Pad from the Front Frame since the Extension Spring 1.554 (front right) may come off. Refer to Figure 4-11, "Screws That Secure the Printer Mechanism" and Figure 4-48, "Removing the Extension Springs 1.554".

- Slightly lift the Printer Mechanism, disconnect the two groups of Cutter Connector Cables from the Main Connector located on the front left side of the Lower Housing as viewed from the printer front, and remove the Printer Mechanism from the Lower Housing. Removal of the Printer Mechanism means that the Lower Housing has also been removed.

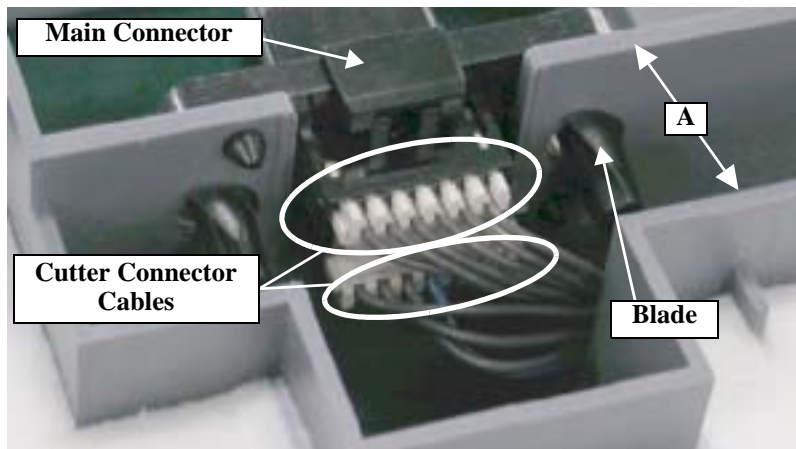


Figure 4-12. Disconnecting the Cutter Connector Cables

REASSEMBLY

When reinstalling the Printer Mechanism, route the Cutter Connector Cables in the groove A shown in Figure 4-12 so that they are not caught between the Printer Mechanism and Lower Housing.

CHECK POINT

When changing the Main Connector, cut the blades of the connector installing hooks with nippers. Refer to Figure 4-12, "Disconnecting the Cutter Connector Cables".

CAUTION

Since the ASP Mechanism does not include the ASF Unit, Printhead, Waste Ink Pads, Main Board and PSB/PSE Board, order them as required.

REASSEMBLY

- When reinstalling the Printer Mechanism, put the front right side Waste Ink Pad into the front of the Front Frame as seen from the printer front, and fix the Waste Ink Pad and Front Frame with double-faced tape. Refer to Figure 4-11, "Screws That Secure the Printer Mechanism".

ADJUSTMENT REQUIRED

When changing the Printer Mechanism, the following adjustments are necessary. Perform the adjustments in the following order.

- PG Adjustment
- CR tooth skip prevention mechanism adjustment
- Head Cleanig
- Head Angle Adjustment
- PF Adjustment
- PW sensor mounting position adjustment
- CR Motor drive torque dispersion measurement (maximum correction value input)

4.2.2 Removing the Board Assembly

4.2.2.1 Removing the Panel Board

1. Remove the Upper Housing. (Refer to 4.2.1.1.)
2. Remove the three screws 5) C.B.P 3×10 (6±1kgf.cm) that secure the Grounding Plate and Panel Board, and remove the Grounding Plate and Panel Board from the Upper Housing.

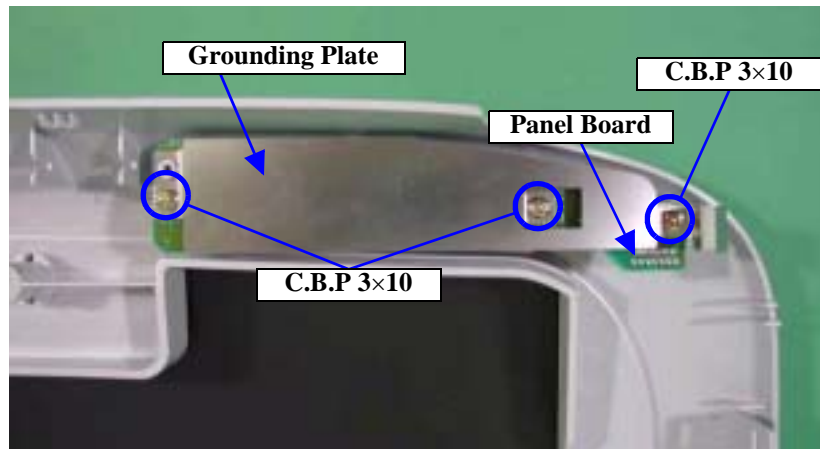


Figure 4-13. Screws That Secure the Grounding Plate and Panel Board

4.2.2.2 Removing the Board Unit

1. Remove the Rear Housing. (Refer to 4.2.1.2.)
2. Remove the five screws 6) C.B.S 3×6 (9±1kgf.cm) and one screw 2) C.B.S 3×10 (9±1kgf.cm) that secure the Board Unit, slightly pull the Board Unit to the front as viewed from the printer rear, and disengage the Ferrite Cores located on the Lower Frame and Board Unit side using a flat-blade screwdriver.

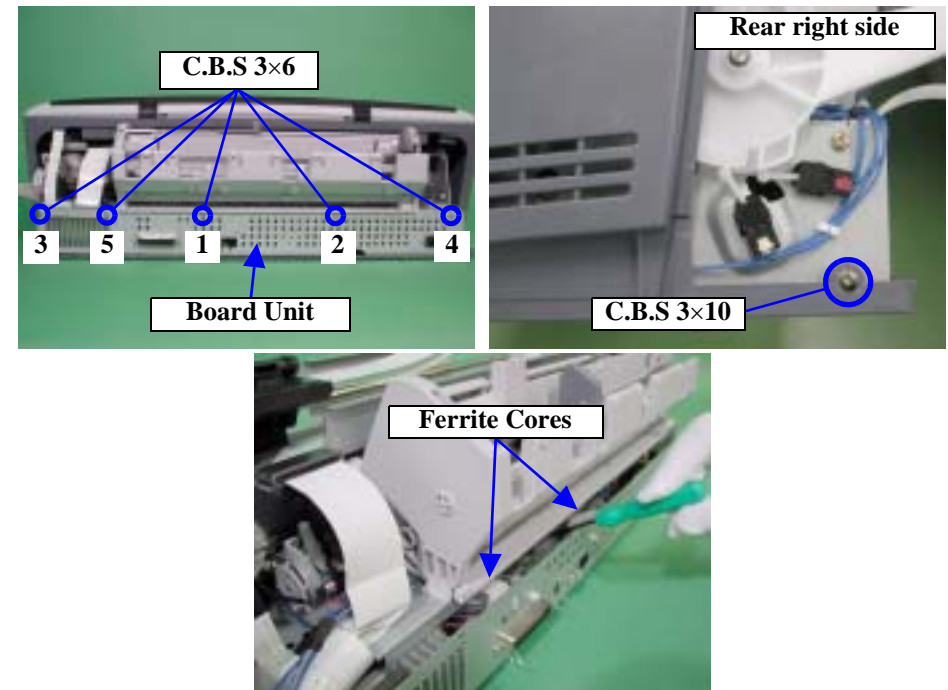


Figure 4-14. Screws That Secure the Board Unit

- Disengage the two Tie Wrap Bands and the hooks of the two Ferrite Cores secured to the Board Unit to release the Connector Cables and FFCs.

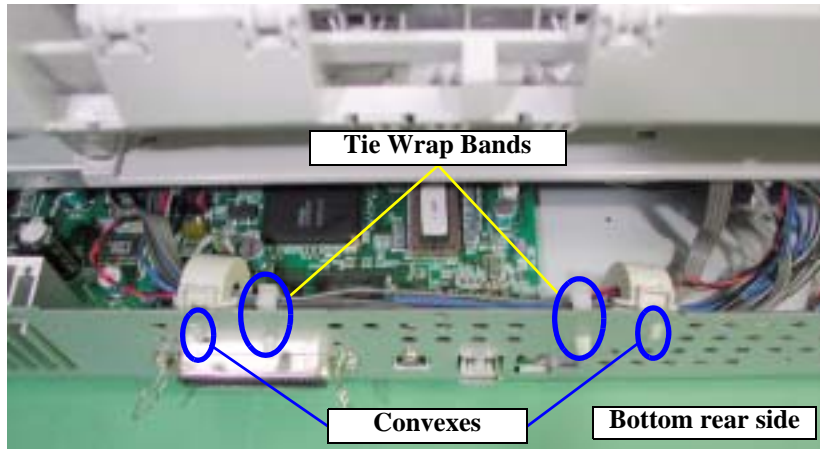


Figure 4-15. Disconnecting the Connector Cables and FFCs

- Disconnect the Connector Cables and FFCs from the Main Board, and pull and remove the Board Unit from the Printer Mechanism again to the front as viewed from the printer rear.



Do not cut the Convexes that secure the Ferrite Cores to the Board Unit.
Refer to Figure 4-15, "Disconnecting the Connector Cables and FFCs".



- Connect the Connector Cables to the Connectors that match in colors and pin counts.
- For the two wide FFCs, connect the one on the printer rear side to CN10 and the one on the front side to CN11. Refer to Figure 4-16, "Connection Destinations of Harnesses and FFCs".

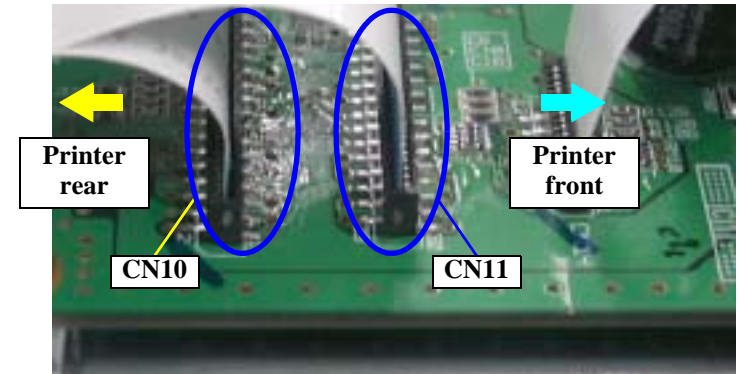


Figure 4-16. Connection Destinations of Harnesses and FFCs

- When reinstalling the Board Unit, fit the screws in the order shown in Figure 4-14.
- When reinstalling the Board Unit, always bundle the Connector Cables and FFCs (narrow FFCs) with the Tie Wrap Bands and Ferrite Cores.
Refer to Figure 4-15, "Disconnecting the Connector Cables and FFCs".

4.2.2.3 Removing the Main Board

1. Remove the Board Unit. (Refer to 4.2.2.2.)
2. Disconnect the Connector Cable from CN15 of the Main Board.

CHECK
POINT



- CN15 has a connector cable lock mechanism. Therefore, before disconnecting the Connector Cable, make sure that the lock mechanism has been cleared. When reconnecting the cable, insert the pins correctly into the corresponding ports of CN15. Refer to Figure 4-17, "Connector Cable Lock Mechanism".
- Mount the pin side, where a blue line is drawn on the Connector Cable, to the 1 pin side. Refer to Figure 4-17, "Connector Cable Lock Mechanism".

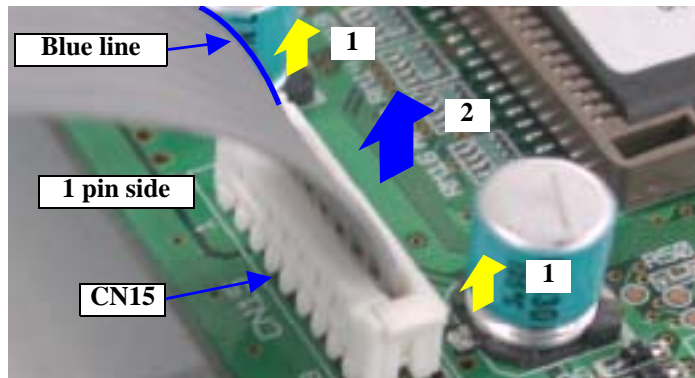


Figure 4-17. Connector Cable Lock Mechanism

3. Remove the five screws 6) C.B.S 3×6 (9±1kgf.cm) and three screws 7) C.P 3×6 (6±1kgf.cm) that secure the Main Board, and remove the Main Board.

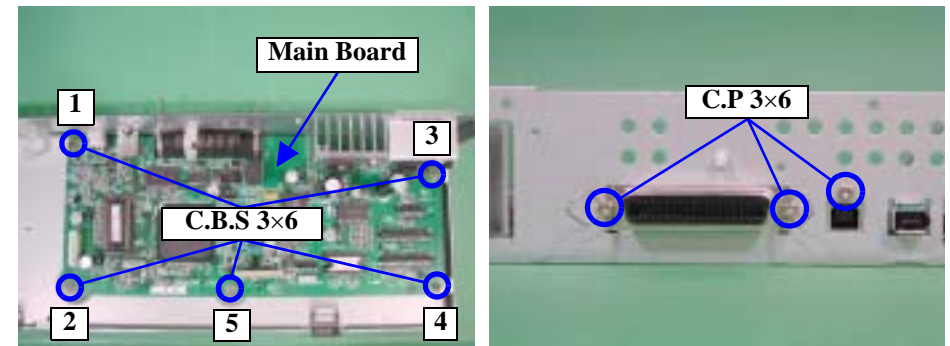


Figure 4-18. Screws That Secure the Main Board



Fit the screws 6) C.B.S 3×6 in the order shown in Figure 4-18.



- When changing the Main Board, the following part change and adjustments are necessary. Perform the adjustments in the following order.

Parts to be changed

- Waste Ink Pads

Adjustment items

1. EEPROM data
 2. EEPROM initialization
 3. USB ID input
 4. IEEE-1394 ID input
 5. Head ID input
 6. Bi-D adjustment
 7. Pixel Shift Adjustment
 8. PF adjustment
 9. PW sensor mounting position adjustment
 10. CR Motor drive torque dispersion measurement (maximum correction value input)
- Refer to "Chapter 5 Adjustment" for the adjustment procedures.
 - When data can be read from the old Board, adjustments and Waste Ink Pad changing are not necessary.

4.2.2.4 Removing the PSB/PSE Board

1. Disconnect the Connector Cable from CN15 of the Main Board. (Refer to Steps 1 and 2 in 4.2.2.3.)
2. Remove the four screws 6) C.B.S 3×6 (9±1kgf.cm) and two screws 8) C.B.P 3×6 (6±1kgf.cm) that secure the PSB/PSE Board, and remove the PSB/PSE Board from the Board Unit.

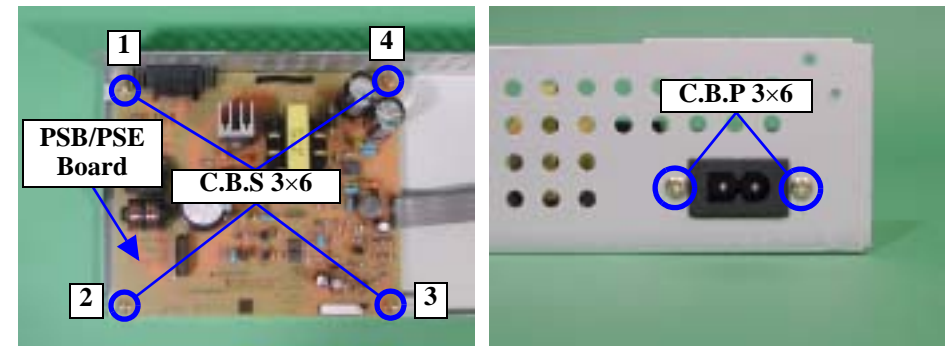


Figure 4-19. Screws That Secure the PSB/PSE Board



- Fit the screws 8) C.B.P 3×6 in the order shown in Figure 4-19.
- Always fit the Protective Sheet under the PSB/PSE Board after matching the two screw holes with those of the Board Unit. Refer to Figure 4-20, "Fitting the Protective Sheet".

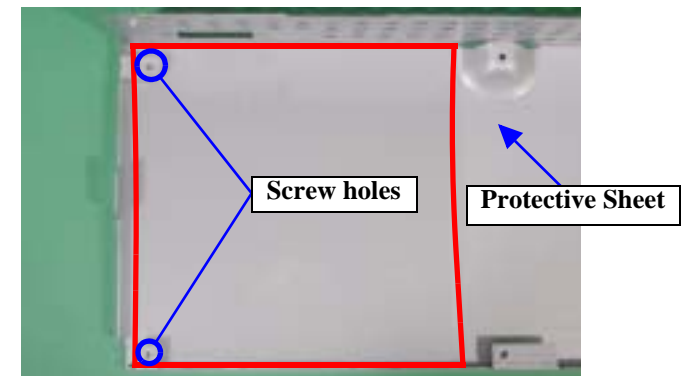


Figure 4-20. Fitting the Protective Sheet



- When changing the PSB/PSE Board, make the following adjustment.
 - CR Motor drive torque dispersion measurement
- Refer to "Chapter 5 Adjustment" for the adjustment procedure.

4.2.3 Removing the Waste Ink Pads

1. Remove the Lower Housing. (Refer to 4.2.1.4.)
2. Peel the Waste Ink Pad Fixing Films, which secure the Waste Ink Pads, from the Lower Housing, and pull up and remove the Waste Ink Pads from the Lower Housing.

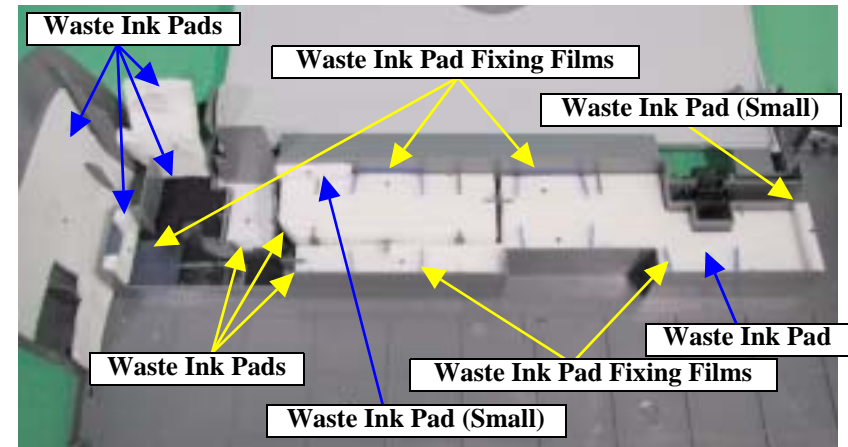


Figure 4-21. Removing the Waste Ink Pads



- The Waste Ink Pads (Small) and the Waste Ink Pads located on the front right side and right side as viewed from the printer front are fixed by double-faced tape. When reapplying them, change the tape if its adhesive force is weak. Refer to Figure 4-21, "Removing the Waste Ink Pads".
- When reapplying the Waste Ink Pad Fixing Films, change them if their adhesive force is weak. Refer to Figure 4-21, "Removing the Waste Ink Pads".
- Fit the Ink Tube in the correct position of the Waste Ink Pads. Refer to Figure 4-22, "Specified Position of the Ink Tube".

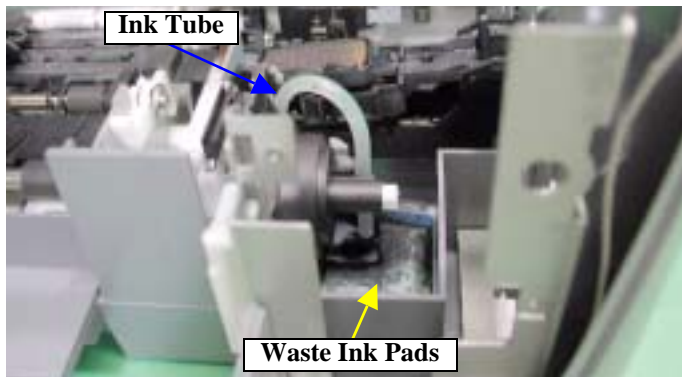


Figure 4-22. Specified Position of the Ink Tube



- When changing the Waste Ink Pads, make the following adjustment.
 - Protection counter reset
- Refer to "Chapter 5 Adjustment" for the adjustment procedure.

4.2.4 Removing the ASF Unit

1. Remove the Rear Housing. (Refer to 4.2.1.2.)
2. Disconnect the Connector Cable of the ASF Sensor from the ASF Unit.
3. Remove the two screws 9) C.B.S (P4) 3×6 (6±1kgf.cm) and one screw 10) CR mount shaft that secure the Roll Paper Guide and ASF Unit.

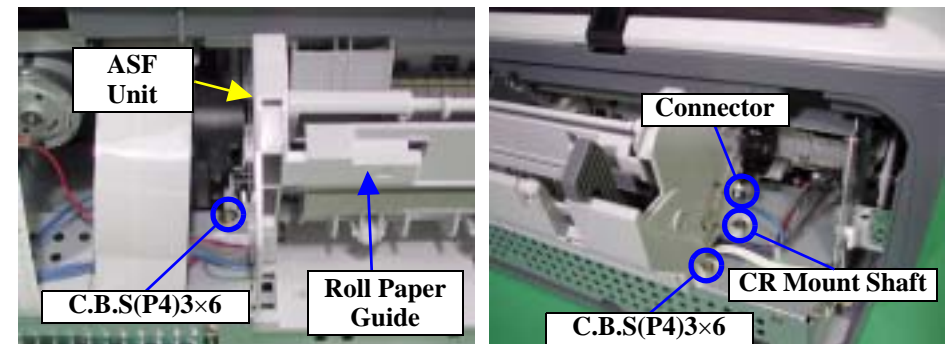


Figure 4-23. Screws That Secure the Roll Paper Guide

4. While lifting the Roll Paper Guide and ASF Unit slightly upward as viewed from the printer rear, slide them to the right to release the three hooks, which secure the Roll Paper Guide, from the Lower Frame, and remove the Roll Paper Guide and ASF Unit.

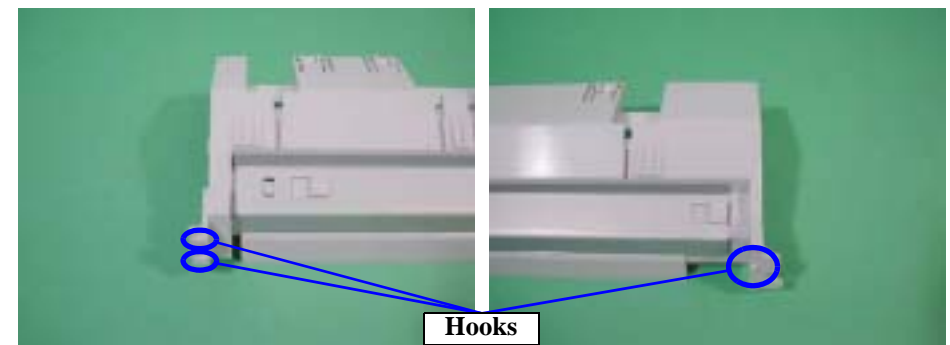


Figure 4-24. Hooks That Secure the Roll Paper Guide

- With the Roll Paper Guide and ASF Unit viewed from the rear, pull the right end of the Roll Paper Guide to the right to remove it from the joggle on the ASF Unit right side, and then remove the Roll Paper Guide from the joggle on the ASF Unit left side.

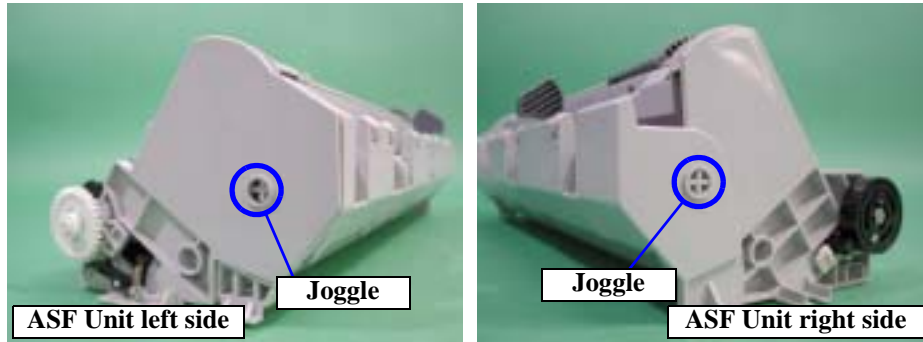


Figure 4-25. Removing the Roll Paper Guide



- Before reinstalling the Roll Paper Guide, insert the joggle on the ASF Unit left side, as viewed from the ASF Unit rear, into the mounting hole of the Roll Paper Holder. Refer to Figure 4-25, "Removing the Roll Paper Guide".
- Insert the round joggle on the ASF Unit front bottom right side, as viewed from the ASF Unit front, into the mounting hole of the Middle Frame located on the left of the printer center as viewed from the printer rear. Refer to Figure 4-26, "Reinstalling the ASF Unit 1".

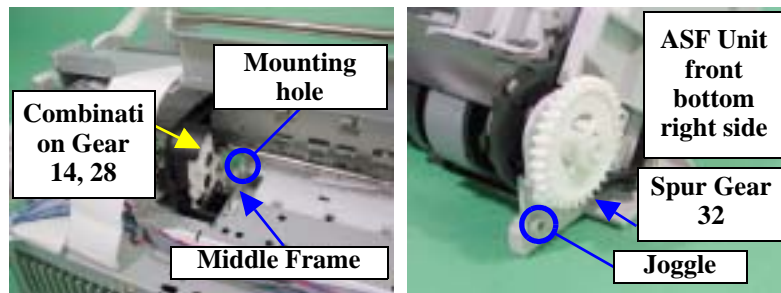


Figure 4-26. Reinstalling the ASF Unit 1



- When reinstalling the ASF Unit, insert the joggle under the left side, as viewed from the printer rear, into the Lower Frame, and the joggle on the rear side into the Front Frame, and make sure that the tooth surface of the Spur Gear 32 in the ASF Unit engages with the tooth surface of the Combination Gear 14, 28 in the DE Unit. Refer to Figure 4-27, "Reinstalling the ASF Unit 2".

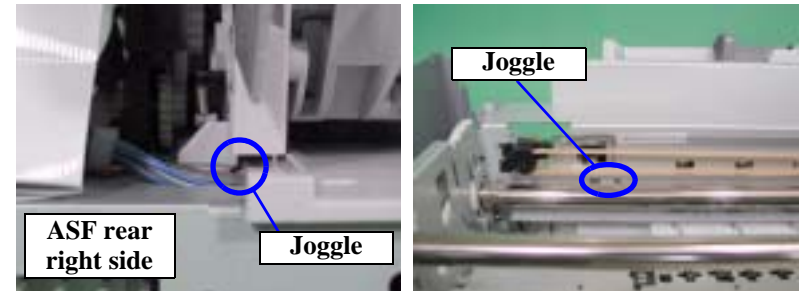


Figure 4-27. Reinstalling the ASF Unit 2



- When changing the ASF Unit, make the following adjustment.
- PW sensor mounting adjustment

4.2.4.1 Disassembling the ASF Unit

1. Remove the ASF Unit. (Refer to 4.2.4.)
2. Remove the one screw 8) C.B.P 3×6 (6±1kgf.cm) that secures the Paper Guide Support.
3. Release the two joggles of the Paper Guide Support with tweezers or like, and while pulling the Paper Guide Support slightly to the front as viewed from the ASF Unit rear, lift it up to release the three hooks, and remove the Paper Guide Support.

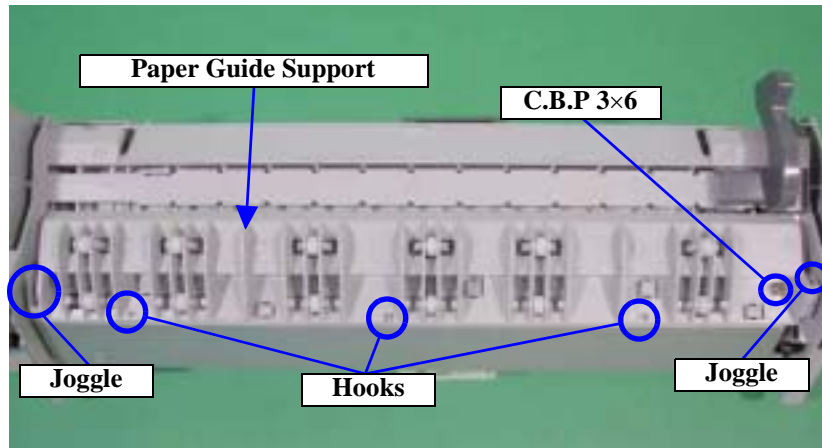


Figure 4-28. Removing the Paper Guide Support

4. Remove the Extension Spring 0.088 hitched on the Right Lever Hopper Cam as viewed from the ASF Unit front, and remove the Right Lever Hopper Cam from the ASF Unit.

CAUTION



When removing the Extension Spring 0.088, fully use care not to lose it.

Refer to Figure 4-29, "Removing the Lever Hopper Cam/Spur Gear 32".

5. Release the one hook that secures the Spur Gear 32, and remove the Spur Gear 32 from the LD Roller Shaft.

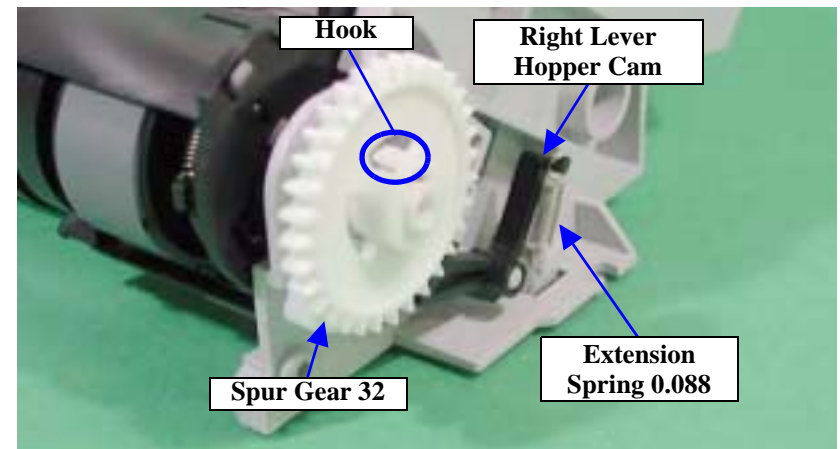


Figure 4-29. Removing the Lever Hopper Cam/Spur Gear 32

6. Remove the E Ring, which secures the Right Hopper Cam, from the LD Roller Shaft, and remove the Right Hopper Cam.

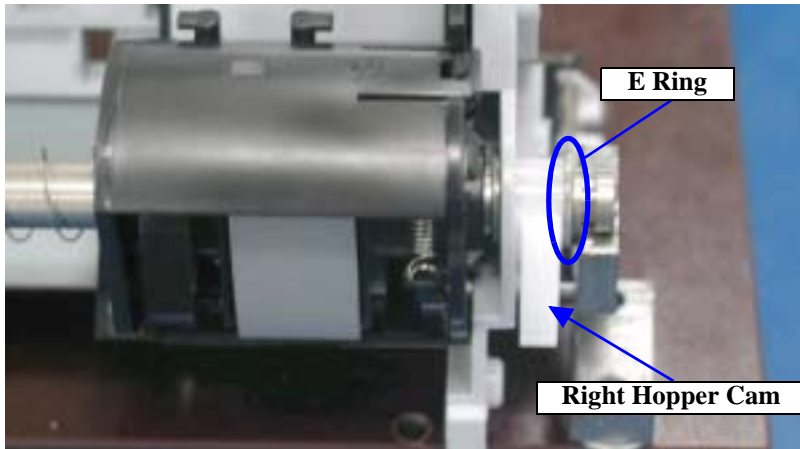


Figure 4-30. Removing the Right Hopper Cam

7. Release the one hook that secures the Left Hopper Cam, and slide the Right Hopper Cam to the right as viewed from the ASF Unit front.
8. Slide the LD Roller Shaft to the left as viewed from the ASF Unit front, and release the one hook that secures the ASF Sensor Wheel to remove the ASF Sensor Wheel from the LD Roller Shaft.

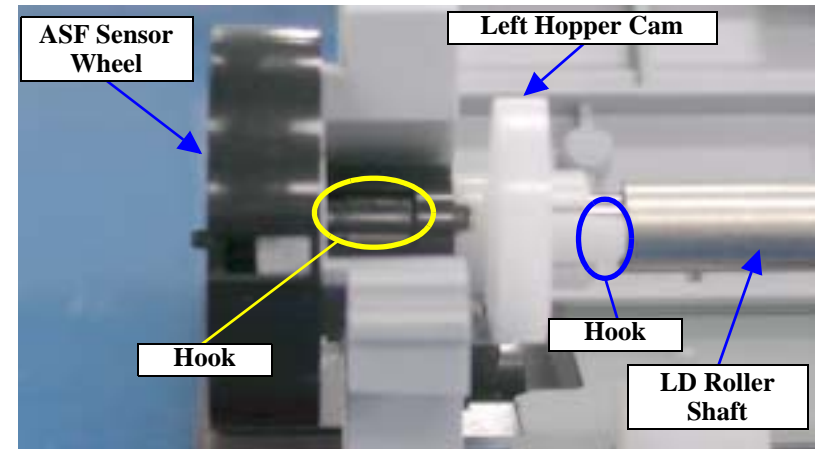


Figure 4-31. Removing the ASF Sensor Wheel

9. Release the one left side hook that secures the Hopper, as viewed from the ASF Unit front, using tweezers or like.
10. While pulling up the left end of the Hopper as viewed from the ASF Unit front, remove the Arm on the right end of the Hopper from the cutout in the ASF Unit right end.
11. After sliding the Hopper, two left and right LD Roller Units, LD Roller Shaft and Left Hopper Cam together to the left, pull the right end to the front to remove the Hopper, two left and right LD Roller Units, LD Roller Shaft and Left Hopper Cam from the ASF Unit.

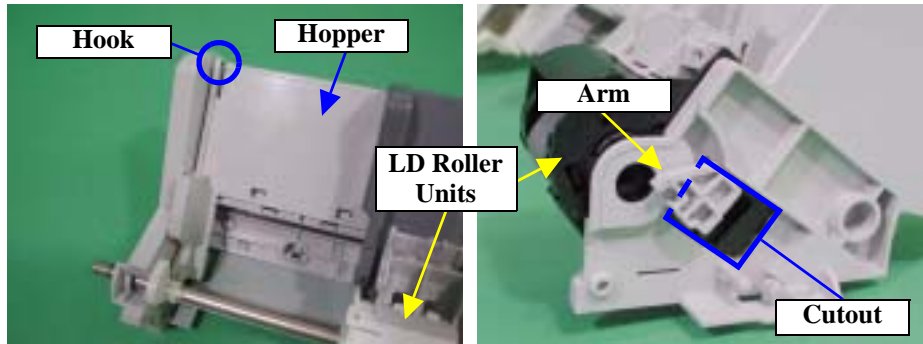


Figure 4-32. Removing the Hopper, Two Left and Right LD Roller Units, LD Roller Shaft and Left Hopper Cam

12. Release one hook of the ASF Frame from the notch in the bottom left of the ASF Frame as seen from the ASF Unit rear, slide the ASF Frame to the right to release the one cutout in the bottom right side of the ASF Frame, and while avoiding the cutout, pull the ASF Under Frame to the diagonal bottom left to move it from the ASF Frame.

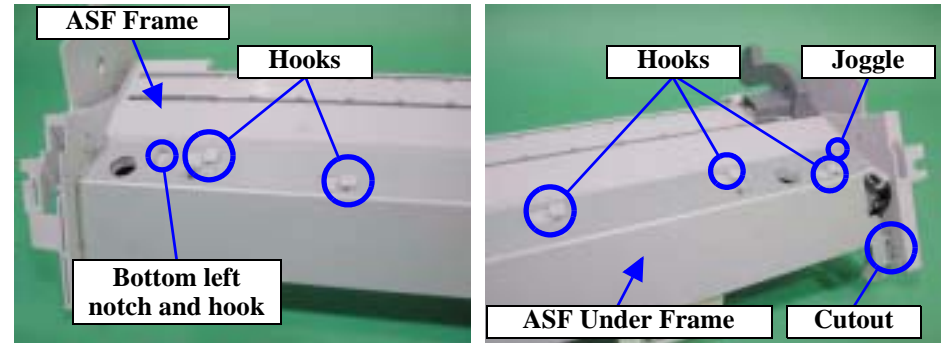


Figure 4-33. Removing the ASF Under Frame



When reinstalling the ASF Under Frame, mount it securely to the six rear side hooks, one bottom right side cutout and rear side joggle. Refer to Figure 4-33, "Removing the ASF Under Frame".

13. Remove the Extension Spring 0.088 hitched on the Left Lever Hopper Cam as viewed from the ASF Unit front, and remove the Left Lever Hopper Cam from the ASF Frame.

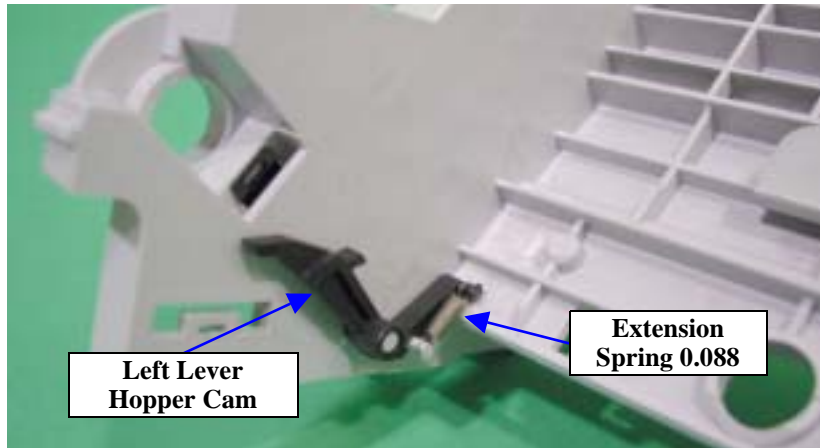


Figure 4-34. Removing the Left Lever Hopper Cam

14. Slide the Left Hopper Cam to the left as seen from the ASF Unit front to remove the Left Hopper Cam from the LD Roller Shaft.
15. Pull and remove the LD Roller Shaft to the left as viewed from the ASF Unit front.

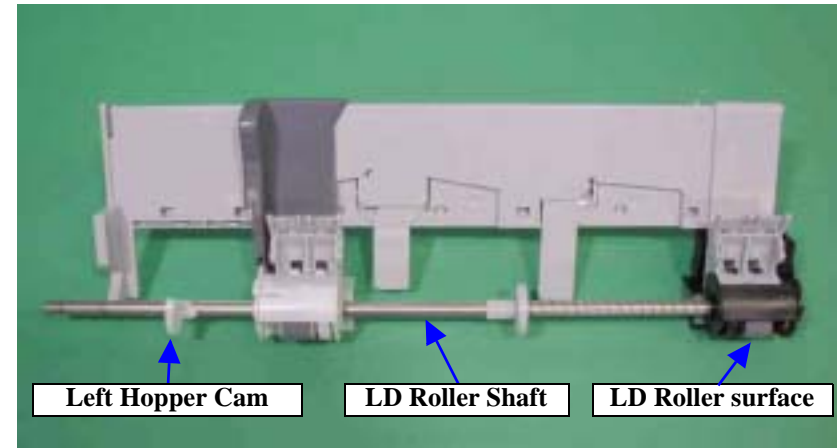


Figure 4-35. Removing the LD Roller Shaft

CAUTION



When removing the Extension Spring 0.088, fully exercise care not to lose it.
Refer to Figure 4-34, "Removing the Left Lever Hopper Cam".

CAUTION



Do not touch the LD Roller surface with bare hands.
Refer to Figure 4-35, "Removing the LD Roller Shaft".

16. Remove the Compression Spring 3.13 that engages the Hopper and Left LD Roller Unit as seen from the ASF Unit front, and remove the Left LD Roller Unit from the Hopper.
17. Remove the Compression Spring 1.961 that engages the Hopper and Right LD Roller Unit as seen from the ASF Unit front, and slide the Right LD Roller Unit to the right to remove the Right LD Roller Unit from the Arm of the Hopper.

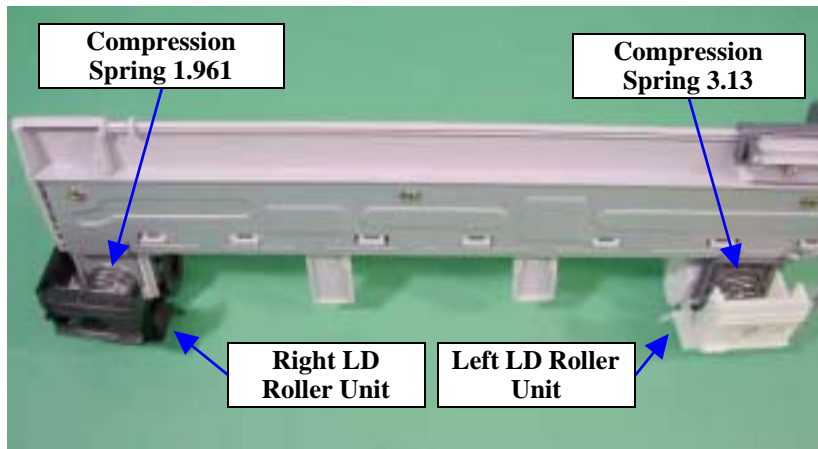


Figure 4-36. Removing the LD Roller Units



- Place the Compression Springs into the Left and Right LD Roller Units correctly. (Place the Compression Spring 1.961 on the right and the Compression Spring 3.13 on the left.) Refer to Figure 4-36, "Removing the LD Roller Units".



- When reinstalling the Compression Spring that engages the Hopper and LD Roller Unit, pre-fix it to the hooks of the Spring Support in the LD Roller Unit. After installing it to the ASF Frame, release the hitched Spring from the rear hole in the ASF Frame. (This also applies to the Right LD Roller Unit.) Refer to Figure 4-37, "Installing the Compression Spring".



Figure 4-37. Installing the Compression Spring



- Reinstall the Left and Right LD Roller Units so that the grooves on the rear side of the LD Roller Units engage the rail of the ASF Frame.
Refer to Figure 4-38, "Reinstalling the LD Roller Units".
- When reinstalling the Left LD Roller Unit to the Edge Guide bottom side of the Hopper, engage the rib of the Left LD Roller Unit with the groove of the Edge Guide as seen from the ASF Unit front.
Refer to Figure 4-38, "Reinstalling the LD Roller Units".

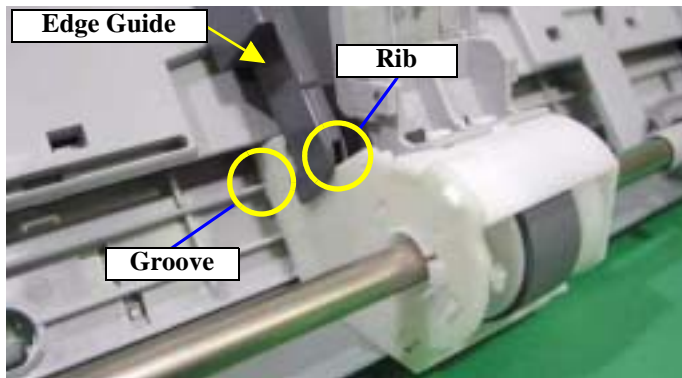


Figure 4-38. Reinstalling the LD Roller Units

- When reinstalling the Left and Right Hopper Cams, place them so that the markings of the Cams face rightward as viewed from the ASF Unit front.
Refer to Figure 4-39, "Marking Position of the Hopper Cam".

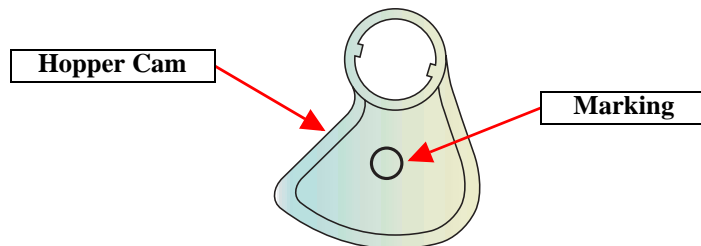


Figure 4-39. Marking Position of the Hopper Cam



- When reinstalling the ASF Sensor Wheel, Left and Right Hopper Cams and LD Roller, refer to Figure 4-40 and face the home position (notch) of the ASF Sensor Wheel, the cam diameters of the Left and Right Hopper Cams and the plane surface of the LD Roller face the same direction.

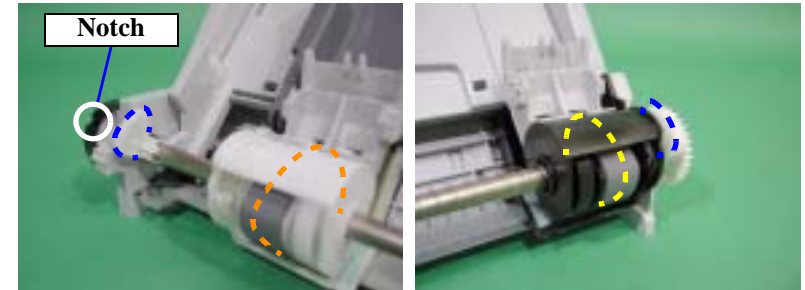


Figure 4-40. Phase Matching



- When changing the following parts for new ones, always apply grease G-26 to the specified places.
 - ASF Frame : Refer to Chapter 6, Figure 6-15, "Lubrication Point 17".
 - Hopper : Refer to Chapter 6, Figure 6-15, "Lubrication Point 17".

4.2.5 Removing the Paper Eject Unit

1. Remove the Printer Mechanism. (Refer to 4.2.1.4.)
2. Move the Release Lever to the far position to increase the platen gap to the maximum.
3. Remove the two screws 6) C.B.S 3×6 (9±1kgf.cm) that secure the Upper Housing Mounting Plate.

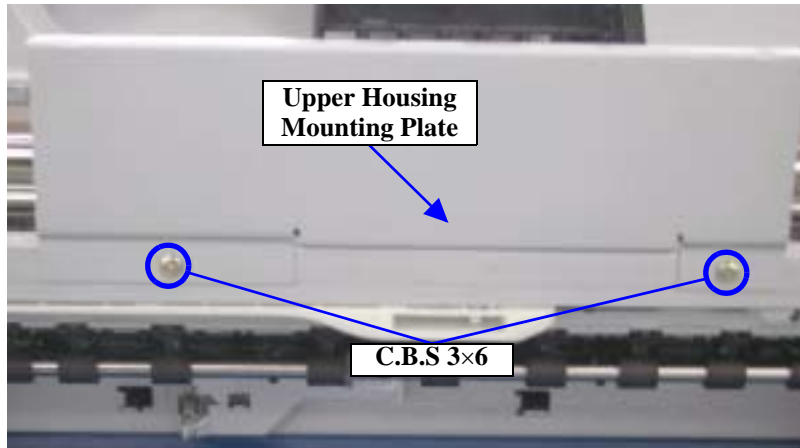


Figure 4-41. Screws That Secure the Upper Housing Mounting Plate

4. Slide the Upper Housing Mounting Plate to the right as viewed from the printer front, and while turning the Upper Housing Mounting Plate toward the printer front, remove it from the Front Frame.

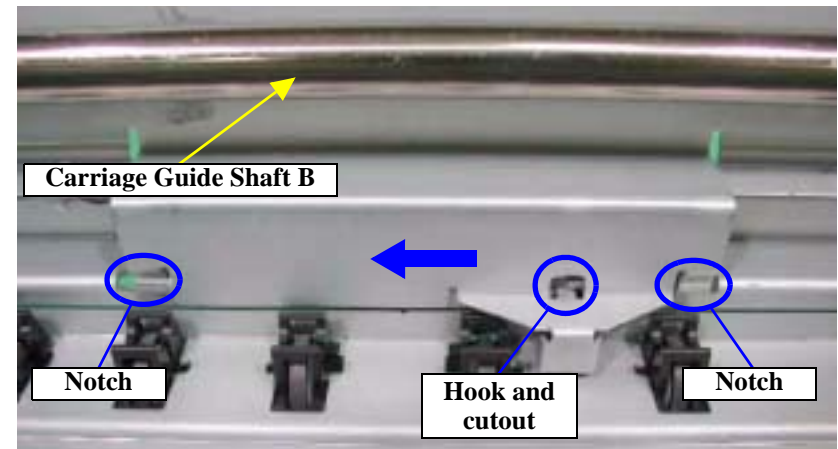


Figure 4-42. Removing the Upper Housing Mounting Plate



CAUTION When removing the Upper Housing Mounting Plate, fully be careful not to scratch the Carriage Guide Shaft B. Refer to Figure 4-42, "Removing the Upper Housing Mounting Plate".



- When reinstalling the Upper Housing Mounting Plate, insert the Compression Spring 2.45 into the joggle in the center of the Paper Eject Unit. Refer to Figure 4-43, "Reinstalling the Upper Housing Mounting Plate".



- Insert the cutouts in the left and right of the Upper Housing Mounting Plate into the notches of the Front Frame, and hitch the cutout of the Upper Housing Mounting Plate on the notch in the center of the Front Frame. Refer to Figure 4-42, "Removing the Upper Housing Mounting Plate".

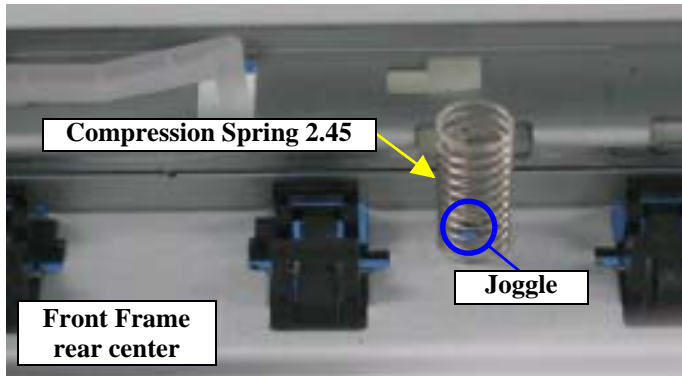


Figure 4-43. Reinstalling the Upper Housing Mounting Plate

5. Remove the three screws 6) C.B.S 3×6 (9±1kgf.cm) that secure the Cutter Support, and remove the Cutter Support from the Printer Mechanism.

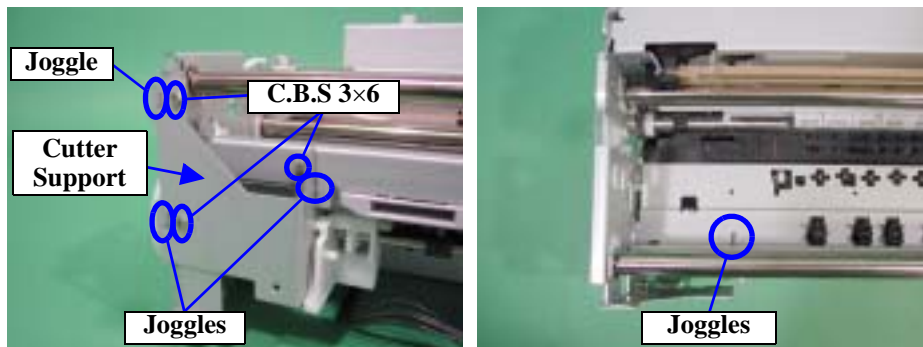


Figure 4-44. Screws That Secure the Cutter Support



- When reinstalling the Cutter Support, insert the four joggles securely to fix the Cutter Support. Refer to Figure 4-44, "Screws That Secure the Cutter Support".
- After reinstalling the Cutter Support, make sure that it is in the normal position since the Paper Eject Unit left side may come off the engagement portions with the Left and Right Frames and shift to the printer left side during installation of the Cutter Support. Refer to Figure 4-45, "Normal Positions of Paper Eject Unit Engagement Portions".

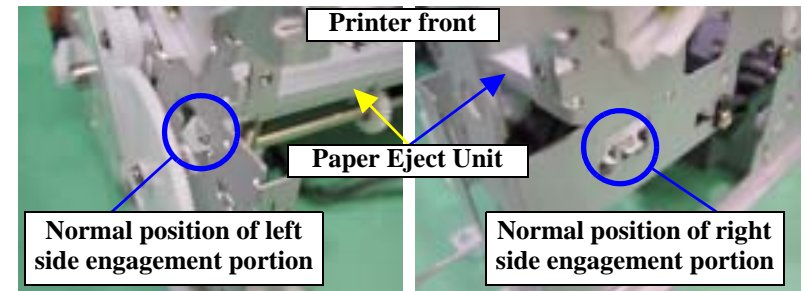


Figure 4-45. Normal Positions of Paper Eject Unit Engagement Portions

6. Remove the three screws 6) C.B.S 3×6 (6±1kgf.cm) that secure the Front Frame.

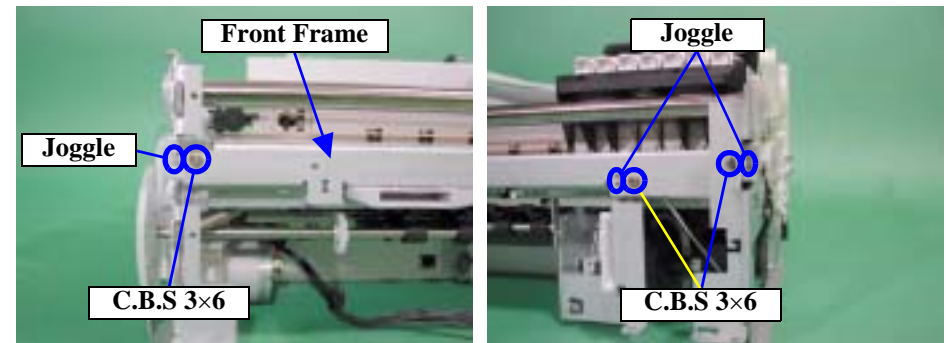


Figure 4-46. Screws That Secure the Front Frame

7. Pull the Front Frame from the Printer Mechanism to the front as seen from the printer front, disconnect the Connector Cable of the CD-R Sensor, release the Connector Cable from the two Tie Wraps, and remove the Front Frame.

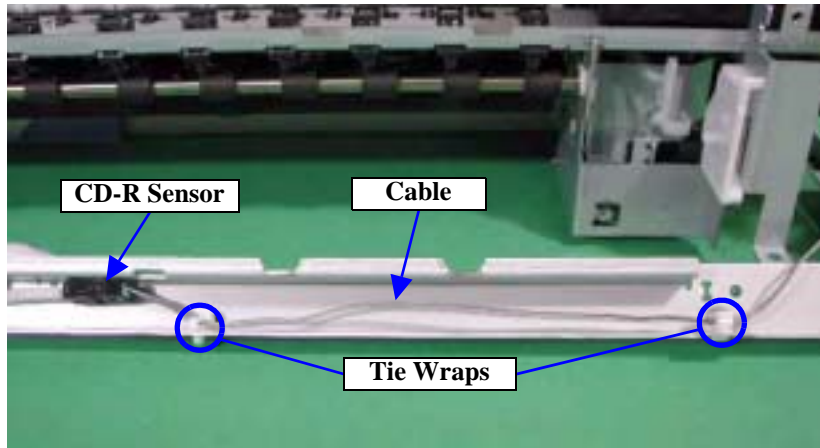


Figure 4-47. Removing the Front Frame



When reinstalling the Front Frame, insert the three joggles into the Front Frame securely. Refer to Figure 4-46, "Screws That Secure the Front Frame".

8. Remove the Extension Springs 1.554 that engage the Paper Eject Unit and Left and Right Frames.

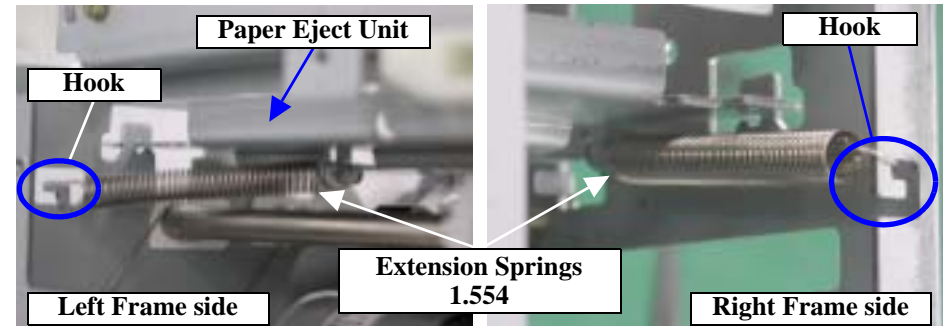


Figure 4-48. Removing the Extension Springs 1.554

9. Move the Carriage Unit to the center.
10. Slide the Paper Eject Unit once to the left as seen from the printer front to release the two left and right engagement portions of the Paper Eject Unit.
11. Slide the Paper Eject Unit to the rear as viewed from the printer front, slightly lift the front side to release the right-hand side hook from the center, and raise the left and right hooks of the Paper Eject Unit and the cutout in the right center side to above the notches of the left and right engagement portions and the right center side hook.

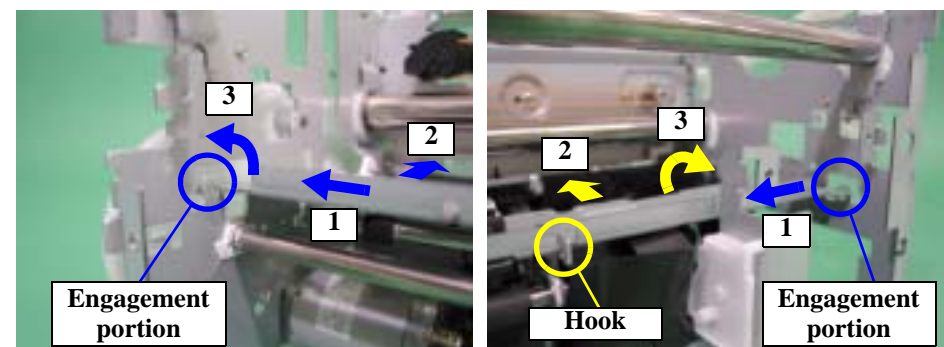


Figure 4-49. Removing the Paper Eject Unit 1

12. Slide the Paper Eject Unit to the right as seen from the printer front, and then also move the Carriage Unit to the right end.
13. While pulling the Left Frame to the left as viewed from the printer front, pull out the left end of the Paper Eject Unit to the front.
14. Move the Carriage Unit to the left end as viewed from the printer front, pull the right end of the Paper Eject Unit out of the Right Frame, and remove it from the Printer Mechanism.



- Make sure that the two Extension Springs 1.554 are fitted in the correct positions. Refer to Figure 4-48, "Removing the Extension Springs 1.554".
- When reinstalling the Paper Eject Unit, make sure that the engagement portions with the Left and Right Frames are fitted properly. Refer to Figure 4-50, "Normal Positions of Paper Eject Unit Engagement Portions".

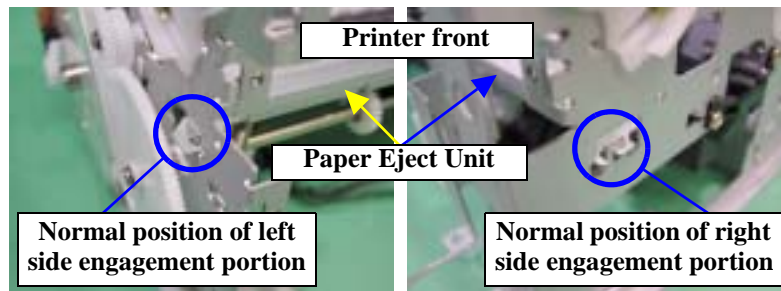


Figure 4-50. Normal Positions of Paper Eject Unit Engagement Portions

- Connect the Connector Cable of the CD-R Sensor correctly using tweezers. Refer to Figure 4-47, "Removing the Front Frame".
- Fix the Connector Cable of the CD-R Sensor correctly with the Tie Wraps in the Front Frame. Refer to Figure 4-47, "Removing the Front Frame".



- Make sure that the U-cut portion on the bottom of the Sub Shaft Mounting Plate located on the inner left side of the Carriage Guide Shaft B as seen from the printer front is installed properly since it may come off the cutout of the Left Frame during removal of the Paper Eject Unit. Refer to Figure 4-51, "Normal Position of the Sub Shaft Mounting Plate".

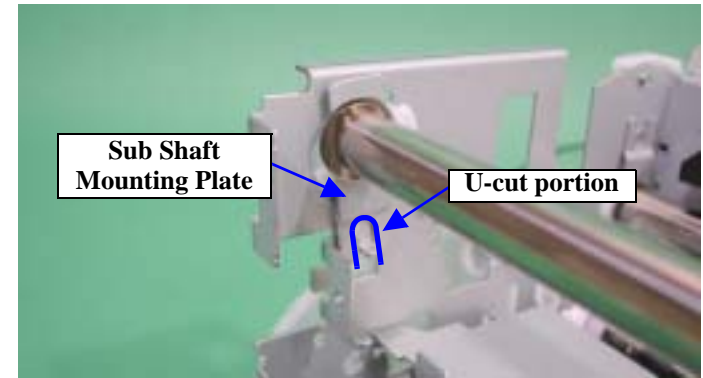


Figure 4-51. Normal Position of the Sub Shaft Mounting Plate

4.2.6 Removing the Paper Eject Roller B

1. Remove the Paper Eject Unit. (Refer to 4.2.5.)
2. Return the Carriage Unit to the home position.
3. Release the four hooks, which secure the rear side of the Lower Paper Guide Eject as seen from the printer front, from the Paper Eject Roller A, and turn it toward the front.
4. Release the five hooks, which secure the front side of the Lower Paper Guide Eject as seen from the printer front, from the Paper Eject Roller B, and remove the Lower Paper Guide Eject.

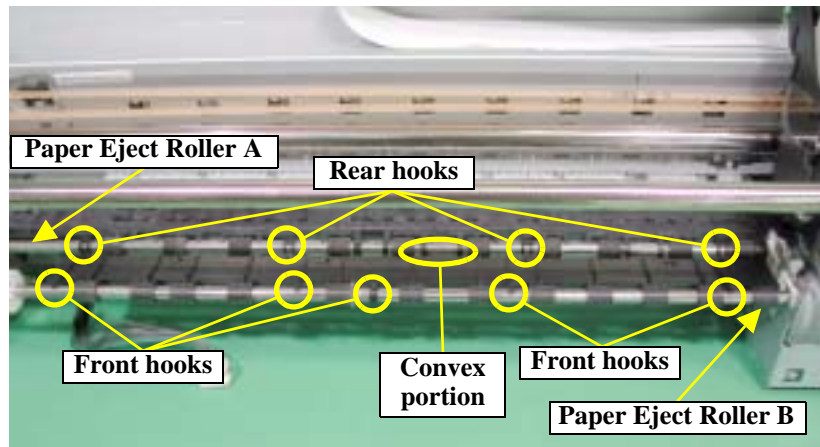


Figure 4-52. Removing the Lower Paper Guide Eject



When reinstalling the Lower Paper Guide Eject, match the convex portion on the rear center side, as seen from the printer front, with the notch of the specified hook on the right center side of the Front Paper Guide.

Refer to Figure 4-52, "Removing the Lower Paper Guide Eject".

5. Remove the C Ring of the Spur Gear 62 mounted on the left end of the Paper Eject Roller B, as seen from the printer front, from the Paper Eject Roller B, and then remove the Spur Gear 62.

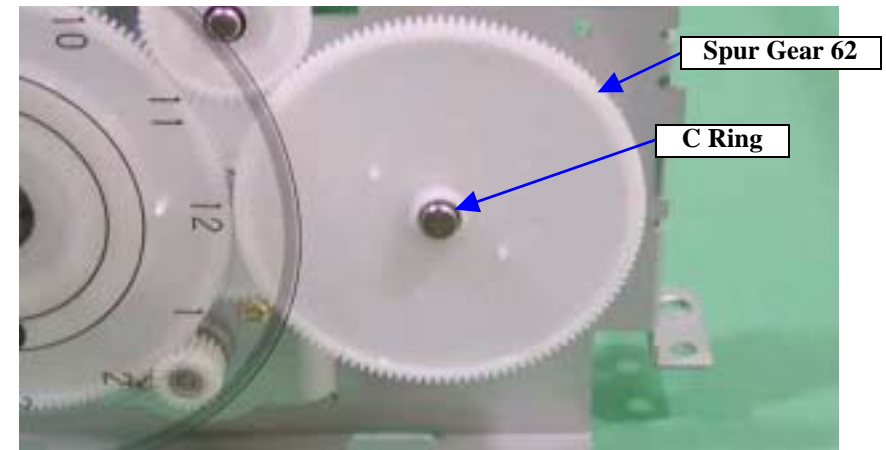


Figure 4-53. Removing the Spur Gear 62



- When removing the C Ring, fully take care not to lose it. Refer to Figure 4-53, "Removing the Spur Gear 62".



- Since the Spur Gear 62 is a precision gear, change it for a new one once it has been removed. Refer to Figure 4-53, "Removing the Spur Gear 62".
- When reinstalling the Spur Gear 62 to the Paper Eject Roller B, hold the center of the Spur Gear 62 and carefully mount it to the Paper Eject Roller B. If you hold the periphery of the Spur Gear 62 when mounting, it will deform and the paper loading accuracy will reduce. Refer to Figure 4-53, "Removing the Spur Gear 62".
- When reinstalling the Spur Gear 62, it is recommended to press-fit the Spur Gear 62 into the Paper Eject Roller B using a mounting plate scale jig.

- Release the Grounding Wire, which is located on the left side of the Paper Eject Roller B as seen from the printer front, from the Left Frame, and remove it from the Paper Eject Roller B.

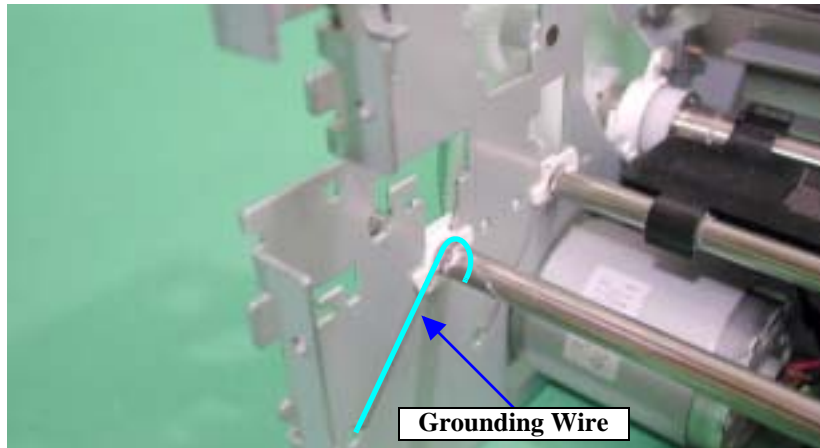


Figure 4-54. Removing the Grounding Wire

- Remove the joggles of the Bushes 6, which secure the left and right of the Paper Eject Roller B to the left and right of the Frame, from the left and right of the Frame, and turn them upward.

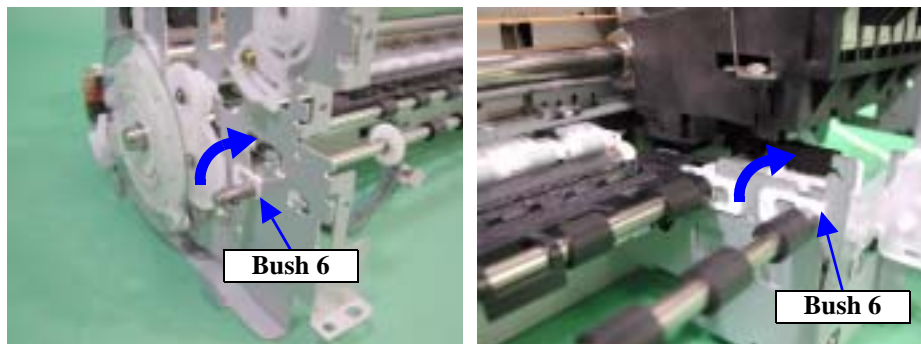


Figure 4-55. Removing the Bushes 6

- Lift the right end of the Paper Eject Roller B as seen from the printer front to remove it from the Right Frame, move the right end of the Paper Eject Roller B to the front, remove the Bush 6 on the left end from the Left Frame, and then remove the Paper Eject Roller B.



- After changing the Lower Paper Guide for a new one, always apply grease G-45 to the specified portions. Refer to Chapter 6, Figure 6-9, "Lubrication Point 11". Refer to Chapter 6, Figure 6-10, "Lubrication Point 12".

4.2.7 Removing the Printhead

1. Remove the Middle Housing. (Refer to 4.2.1.3.)
2. Remove the Ink Cartridges.
3. Pull and release the two left and right joggles, which secure the I/C Cover to the Carriage Unit, inward and remove the I/C Cover from the Carriage Unit.

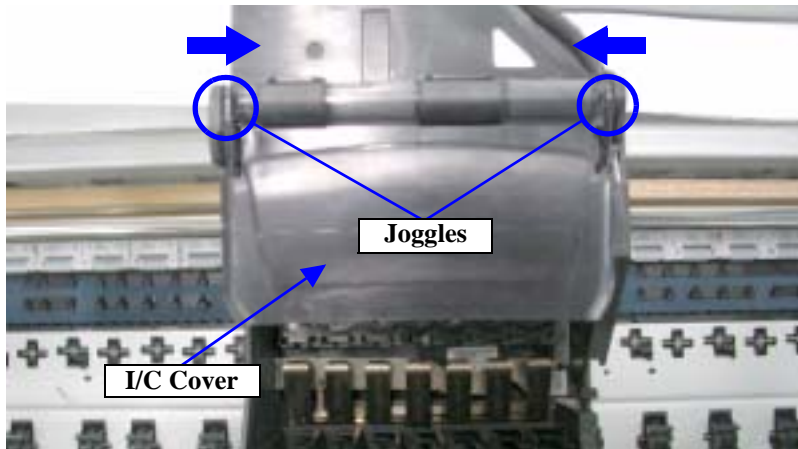


Figure 4-56. Removing the I/C Cover

4. Move the Carriage Unit to the printer center.
5. Release the four hooks that secure the Head Cable Holder to the Carriage Unit, and lift and remove the Head Cable Holder from the Carriage Unit.

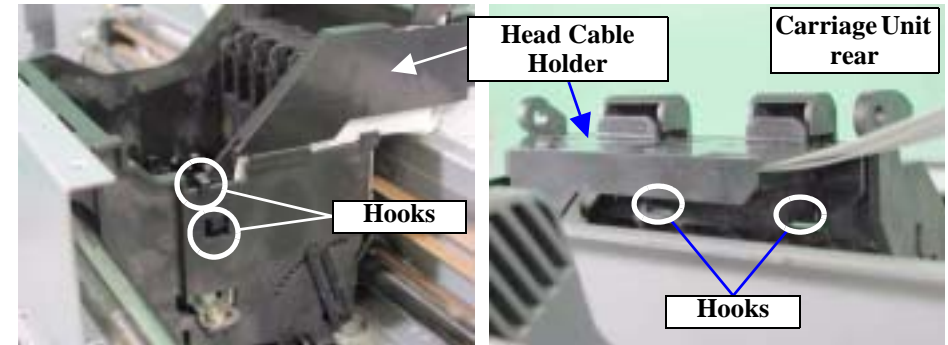


Figure 4-57. Removing the Head Cable Holder

6. Release the Torsion Spring 66 from the hook of the Head Fastener.
7. Remove the two screws 8) C.B.P 3×6 (6±1kgf.cm) that secure the Head Fastener.

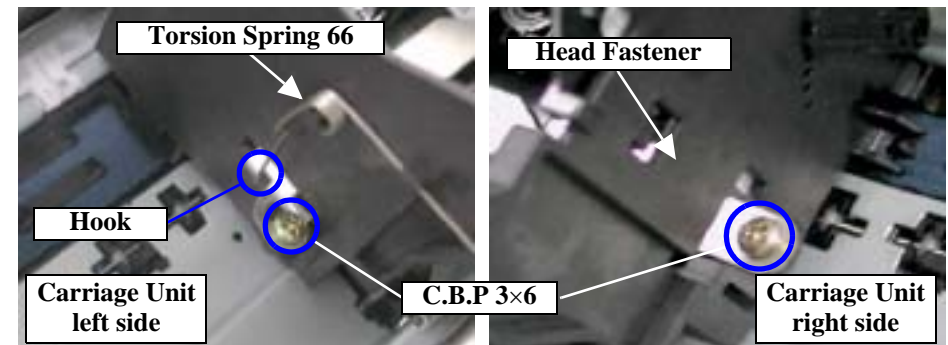


Figure 4-58. Removing the Screws That Secure the Head Fastener



When removing the Torsion Spring 66, hitch the longer end of the Spring on the front center side hook of the Carriage Unit and on the left side hook of the Carriage Unit, and the shorter end on the Head Fastener.

Refer to Figure 4-59, "Reinstalling the Torsion Spring 66".

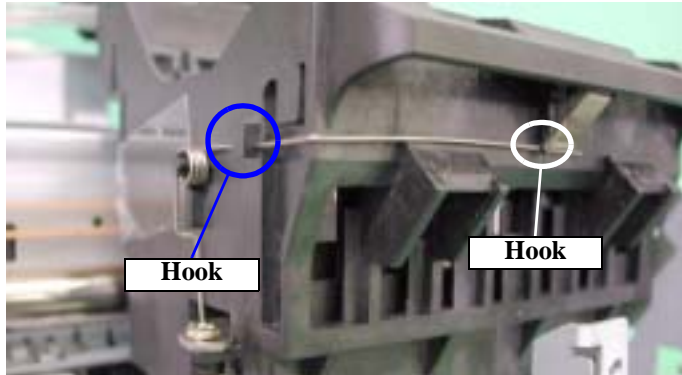


Figure 4-59. Reinstalling the Torsion Spring 66

8. Lift the two overlapping Sus-Plates with pliers or like, and remove them from the Carriage Unit.

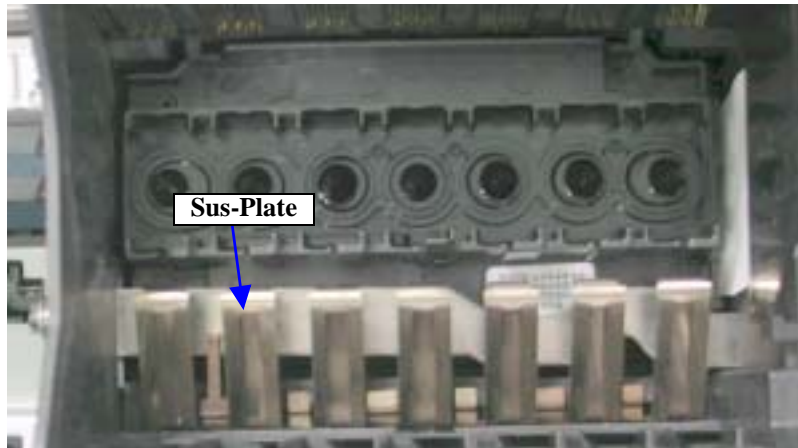


Figure 4-60. Removing the Sus-Plates

9. Slide the Head Fastener to the left as viewed from the printer front, pull the right end to the diagonal top right of the Carriage Unit, and remove the Head Fastener.
10. Slide the Printhead to the front as seen from the printer front, and remove and lift it from the two hooks of the Carriage Unit.

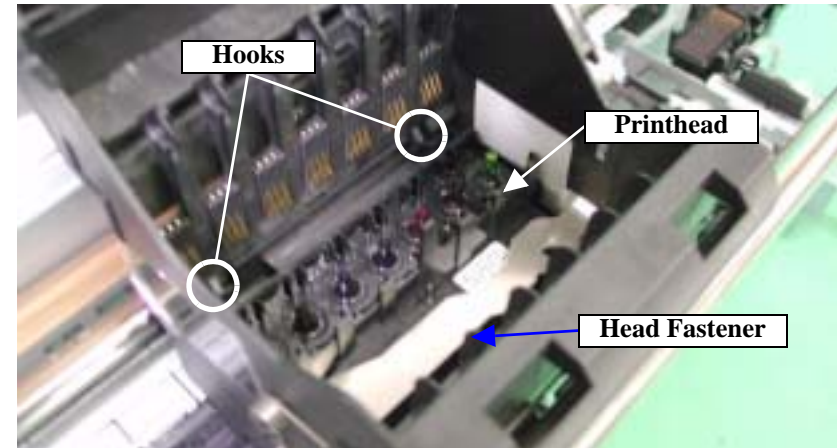


Figure 4-61. Removing the Head Fastener

11. Remove the two Head FFC Guides from the Printhead, and remove the Printhead.

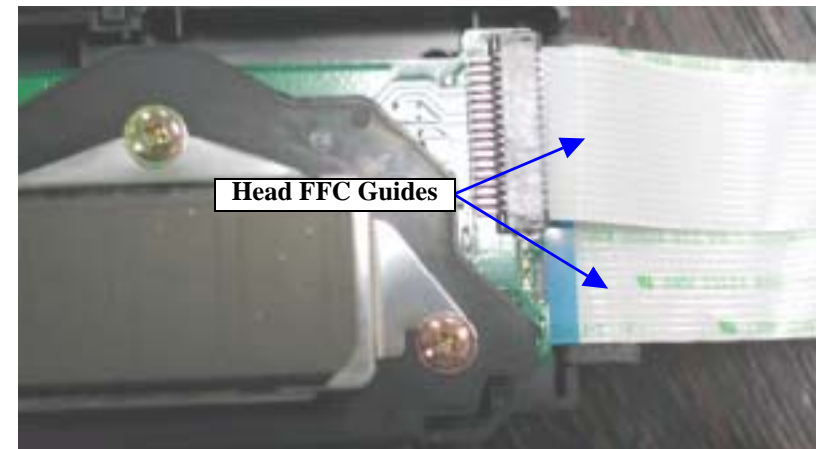


Figure 4-62. Removing the Printhead



- When reinstalling the Printhead, fully take care not to bring the Nozzle surface into contact with the Carriage Unit. Refer to Figure 4-62, "Removing the Printhead".
- After removing the Printhead (when not changing it), place it so that the Head surface does not make contact with the desktop. Refer to Figure 4-62, "Removing the Printhead".



- Refer to Figure 4-63 for the way to route the Head FFC Guides.
- When reinstalling the Head FFC Guides, fully be careful not to bend or damage the FFCs. (Especially the two places in the right photo in Figure 4-63.)
- Place the Head FFCs in the return portion on the right and rear sides of the Carriage. Refer to the right photo in Figure 4-63, "Routing the Head FFC Guides".

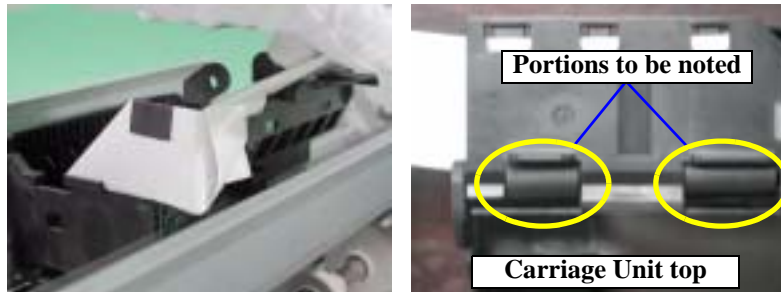


Figure 4-63. Routing the Head FFC Guides



After removing or changing the Printhead, adjustments are necessary.

Always make adjustments in the following order.

- When the Printhead was removed
 1. Head cleaning
 2. Head angular adjustment
 3. Bi-D adjustment
 4. Pixel Shift Adjustment
- When the Printhead was changed
 1. Ink charge
 2. Head ID input
 3. Head angular adjustment
 4. Bi-D adjustment
 5. Pixel Shift Adjustment
 6. PG adjustment

Refer to "Chapter 5 Adjustment" for the adjustment procedures.

CHECK
POINT

- The ASP structure of the Head FFC Guide is the Head FFC Guide, Sponge, Ferrite Core and double-faced tape. When changing the Head FFC Guide, reinstall it after making sure that the Sponge and Ferrite Core are fitted in the correct positions. Leave a 0 to 2mm clearance above the Sponge and Frame.

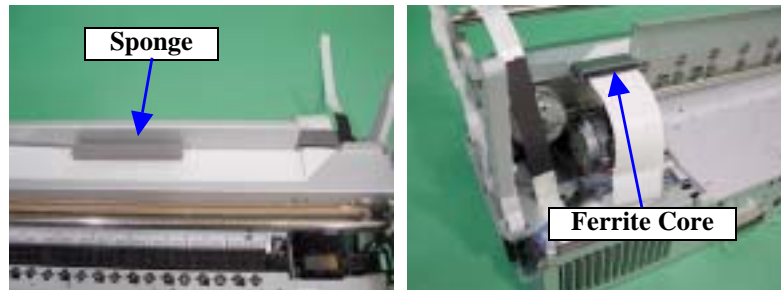


Figure 4-64. Normal Position of Ferrite Core

4.2.8 Removing the Carriage Guide Shaft B

1. Remove the Printer Mechanism. (Refer to 4.2.1.4.)
2. Slightly slide the Carriage Unit to the left as viewed from the printer front, move the Release Lever to the thick paper print position, and remove the PG Change Spring Link from the PG Change Lever.

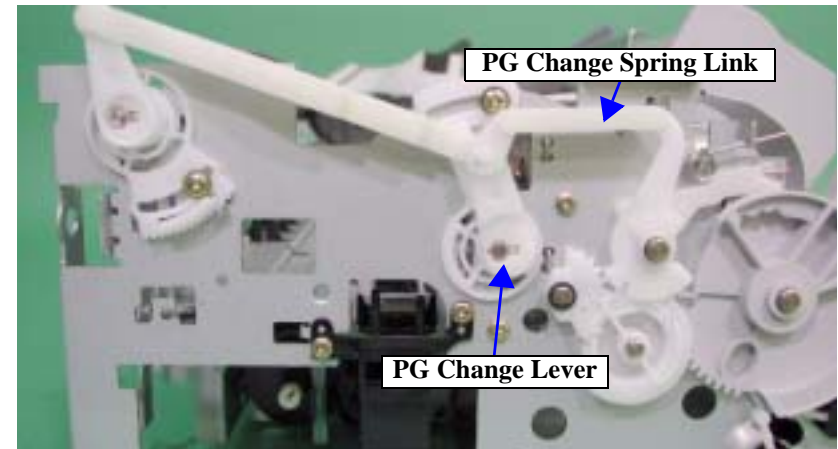


Figure 4-65. Removing the PG Change Spring Link

3. Turn the PG Change Bush and PG Change Lever clockwise as seen from the printer right side until the shape of the cutout in the right end of the PG Change Link matches that of the cutout in the PG Change Lever. Then, pull the PG Change Lever to the front and remove the cutout of the PG Change Link.

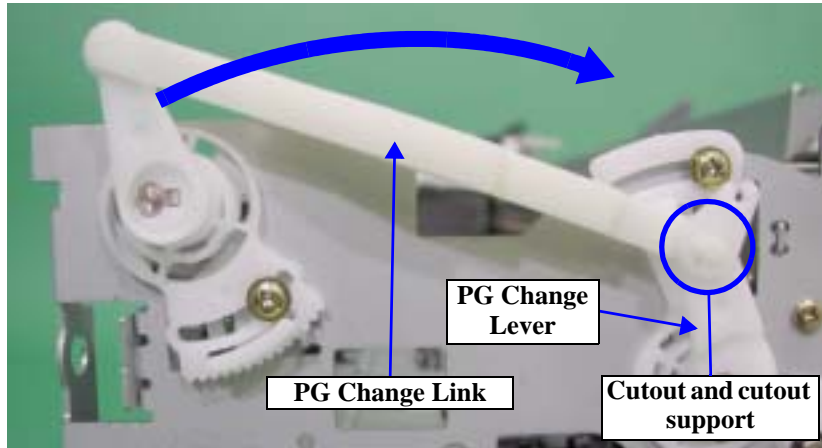


Figure 4-66. Removing the PG Change Link

4. Release the hook of the PG Change Bush from the Carriage Guide Shaft B, and remove the PG Change Bush and PG Change Link together from the Carriage Guide Shaft B.

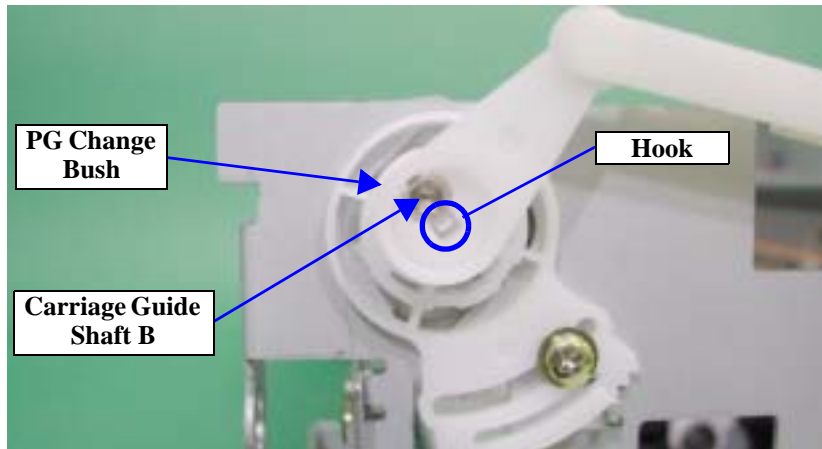


Figure 4-67. Removing the PG Change Bush and PG Change Link



Since the hook of the PG Change Bush is easily damaged, handle it very carefully.
Refer to Figure 4-67, "Removing the PG Change Bush and PG Change Link".

5. Remove the one screw 9) C.B.S (P4) 3×6 (6±1kgf.cm) that secures the Sub Right Adjust Parallelism Bush, and while slightly pulling the bottom side (tooth surface) of the Sub Right Adjust Parallelism Bush to the front as viewed from the printer right side, turn it counterclockwise to release the two hooks, and then remove the Sub Right Adjust Parallelism Bush from the Right Frame.

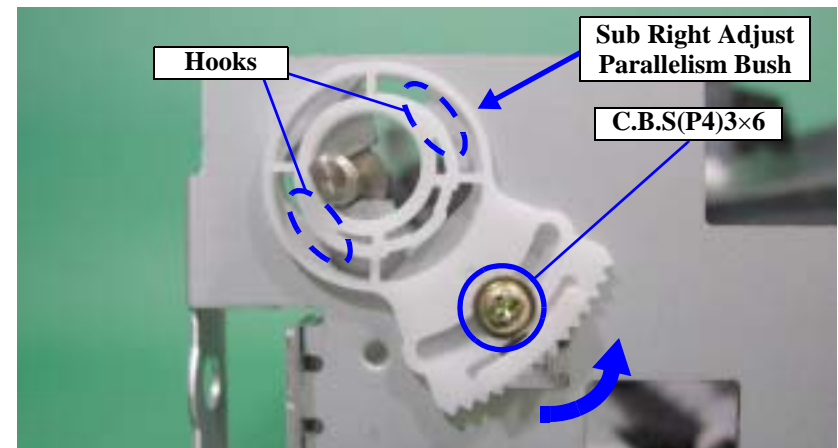


Figure 4-68. Removing the Sub Right Adjust Parallelism Bush

- Lift the right end of the Carriage Guide Shaft B as seen from the printer front, remove the Sub Shaft Fixing Plate (Right) from the hook of the Right Frame, and turn the Sub Shaft Fixing Plate (Right) to remove it from the Carriage Guide Shaft B.

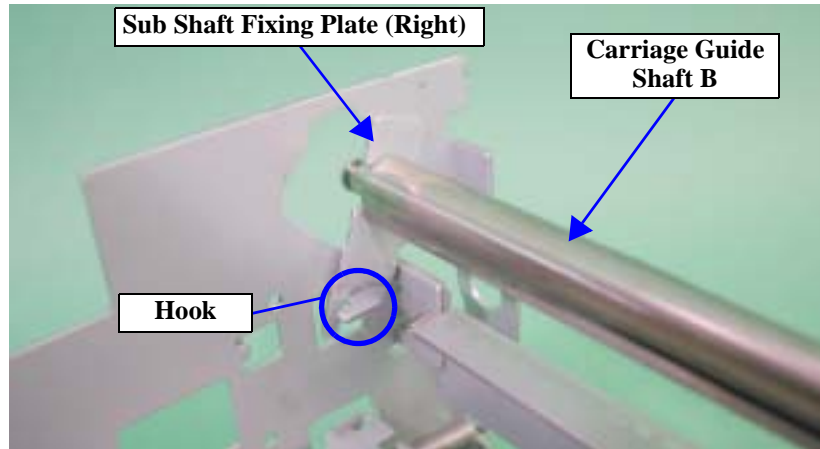


Figure 4-69. Removing the Sub Shaft Fixing Plate (Right)



When reinstalling the Sub Shaft Fixing Plate to the Carriage Guide Shaft B, insert the leg of the Carriage Guide Shaft B in the direction shown in Figure 4-70 and then turn it.

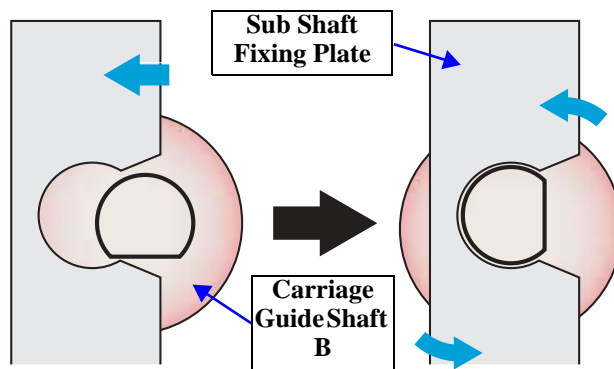


Figure 4-70. Reinstalling the Sub Shaft Fixing Plate

- Slide the Carriage Guide Shaft B to the right as seen from the printer front, then remove the left end from the Frame, and remove the Carriage Guide Shaft B to the diagonal top left of the Printer Mechanism.



- When removing the Carriage Guide Shaft B, fully take care not to scratch it. Refer to Figure 4-69, "Removing the Sub Shaft Fixing Plate (Right)".
- Removing the Carriage Guide Shaft B brings the Carriage Unit into contact with the Front Paper Guide. Therefore, when the Printhead is installed on the Carriage Unit, remove the Carriage Shaft B after moving the Carriage Unit to the home position.



- Make sure that the left end of the Carriage Guide Shaft B is in order of the Bush, Sub Shaft Fixing Plate (Left), Plain Spring and Leaf Spring. Refer to Figure 4-71, "Order on Left End of Carriage Guide Shaft B".

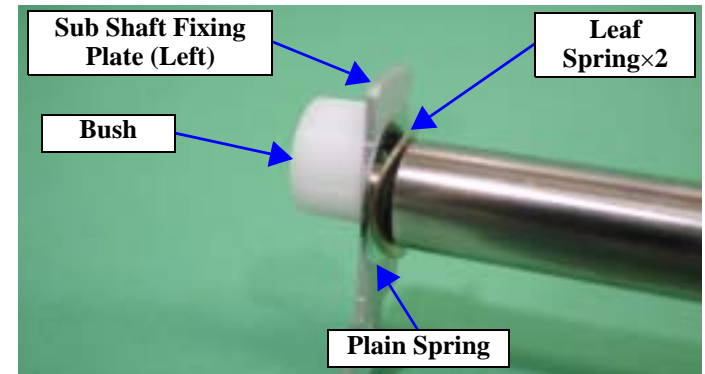


Figure 4-71. Order on Left End of Carriage Guide Shaft B

- After reinstalling the Carriage Guide Shaft B, always make sure that the Sub Shaft Fixing Plate is mounted correctly. Refer to Figure 4-69, "Removing the Sub Shaft Fixing Plate (Right)".



- When changing or removing the Carriage Guide Shaft B, make the following adjustment.
 - PG adjustment
- After changing the following parts for new ones, always apply grease G-26 or G-56 in the specified positions.
 - Sub Left Adjust Parallelism Bush:
Refer to Chapter 6, Figure 6-19, "Lubrication Point 21".
 - Sub Right Adjust Parallelism Bush:
Refer to Chapter 6, Figure 6-20, "Lubrication Point 22".
 - Carriage Guide Shaft B:
Refer to Chapter 6, Figure 6-21, "Lubrication Point 23".

4.2.9 Removing the Carriage Guide Shaft A and Carriage Unit

1. Remove the Printer Mechanism. (Refer to 4.2.1.4.)
2. Remove the Printer Head. (Refer to 4.2.7.)
3. Remove the Extension Spring 1.494 hitched on the left side of the CR Linear Scale as seen from the printer front.



Be fully careful when removing the Extension Spring 1.494 since pulling it more than necessary will elongate the Spring. Refer to Figure 4-72, "Removing the CR Linear Scale".



The Extension Spring 1.494 does not drop if it is removed from the left hook. Refer to Figure 4-72, "Removing the CR Linear Scale".

4. Remove the right side of the CR Linear Scale as viewed from the printer front.
5. Remove the left side of the CR Linear Scale as viewed from the printer front by turning it 90° (either upward or downward).

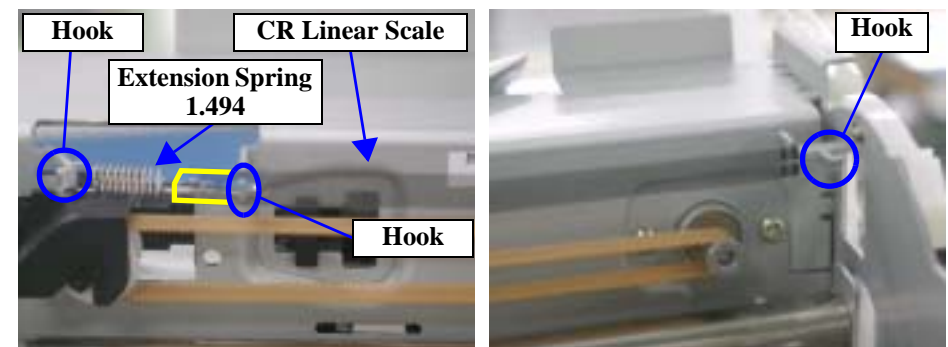


Figure 4-72. Removing the CR Linear Scale

- Pull the CR Linear Scale toward the left side of the Carriage Unit as seen from the printer front.



Pulling the CR Linear Scale from the right side of the Carriage Unit may damage the Extension Spring 1.494. Therefore, always remove the Spring 1.494 first, then remove the right end of the CR Linear Scale, and pull the CR Linear Scale from the left side of the Carriage Unit.

Refer to Figure 4-72, "Removing the CR Linear Scale".



- When reinstalling the CR Linear Scale, do not twist the leg of the Extension Spring 1.494.

Refer to Figure 4-72, "Removing the CR Linear Scale".

- Reinstall the CR Linear Scale with the cut portion of its left end facing upward as viewed from the printer front. (To install its front and rear sides precisely)

Refer to Figure 4-72, "Removing the CR Linear Scale".

- Pull the FFC from the Connector of the CR Encoder Sensor Board on the back of the Carriage Unit.

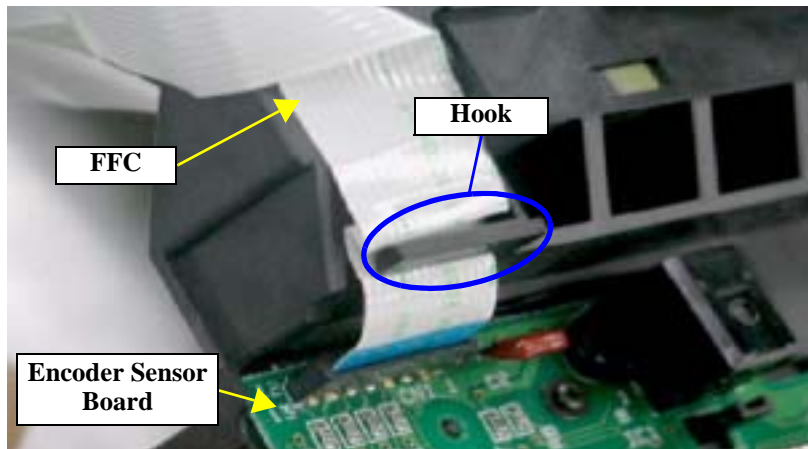


Figure 4-73. Removing the FFC



When reinstalling the Carriage Unit, connect the FFC to the Encoder Sensor Board in advance, then fit the Carriage Guide Shaft A to the Carriage Unit and fix the Carriage Unit to the Printer Mechanism. If you attempt to fit the FFC after reinstalling the Carriage Unit and Carriage Guide Shaft A as in the reversal of the disassembly procedure, the FFC cannot be connected correctly or may be damaged.

Refer to Figure 4-73, "Removing the FFC".



Before connecting the FFC to the CR Encoder Sensor Board, hitch it on the hook of the Carriage Unit.

Refer to Figure 4-73, "Removing the FFC".

- Loosen the one screw 6) C.B.S 3x6 (6±1kgf.cm) that secures the Driven Pulley Stopper Holder.

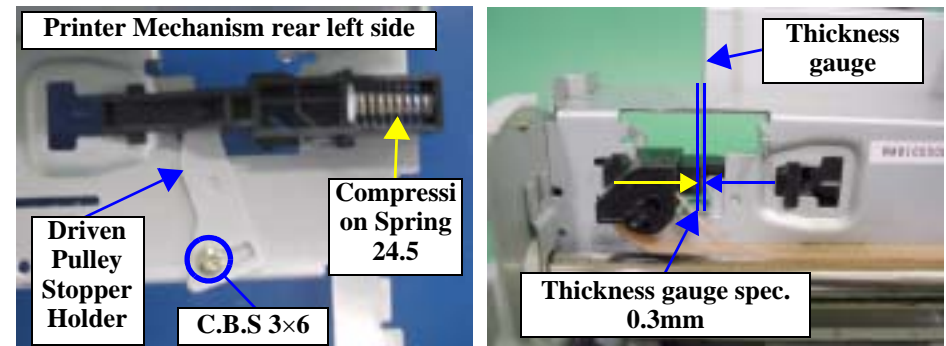


Figure 4-74. Releasing the Driven Pulley Stopper Holder



When reinstalling the Driven Pulley Stopper Holder, provide a clearance by inserting a 0.3mm thickness gauge between the Driven Pulley Holder and Driven Pulley Stopper Holder.

Refer to Figure 4-74, "Releasing the Driven Pulley Stopper Holder".

9. While pushing the Driven Pulley Holder to the right as seen from the printer front, loosen the Timing Belt and remove the Timing Belt from the Pinion Gear of the CR Motor.

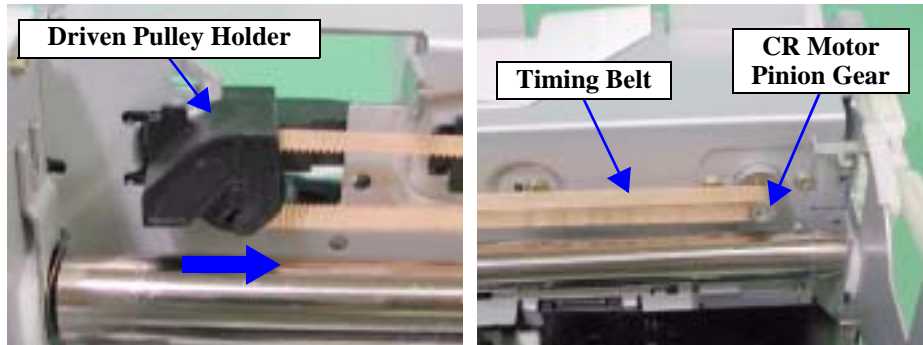


Figure 4-75. Removing the Timing Belt

10. Remove the Compression Spring 24.5 mounted on the Driven Pulley Holder.
11. Slide the Driven Pulley Holder to the right, as seen from the printer front, to remove the Driven Pulley Holder from the Frame.
12. Remove the PG Change Link from the PG Change Lever. (Refer to Steps 2 and 3 in 4.2.8.)

13. Release the hook of the PG Change Lever and remove the PG Change Lever from the Carriage Guide Shaft A.

CAUTION



Handle the hook of the PG Change Lever fully carefully since it is easily damaged. Refer to Figure 4-76, "Removing the PG Change Lever".

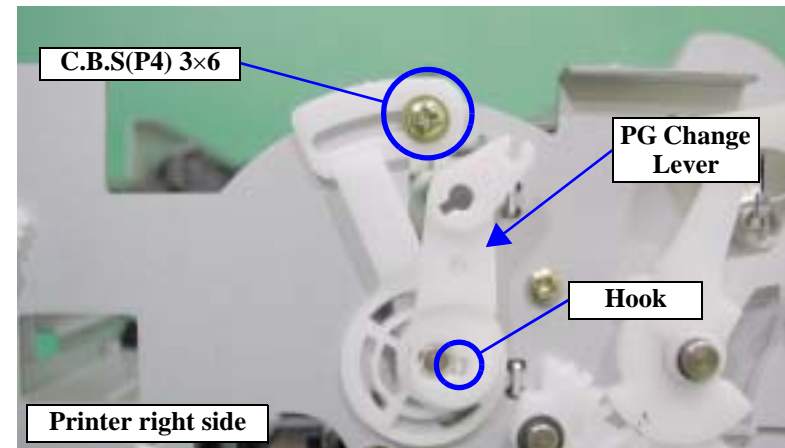


Figure 4-76. Removing the PG Change Lever

14. Remove the one screw (9) C.B.S (P4) 3×6 (6±1kgf.cm) that secures the Right Adjust Parallelism Bush, and while pulling the upper side (tooth surface) of the Right Adjust Parallelism Bush to the front slightly as viewed from the printer right side, turn it counterclockwise to release the two hooks, and then remove the Right Adjust Parallelism Bush.

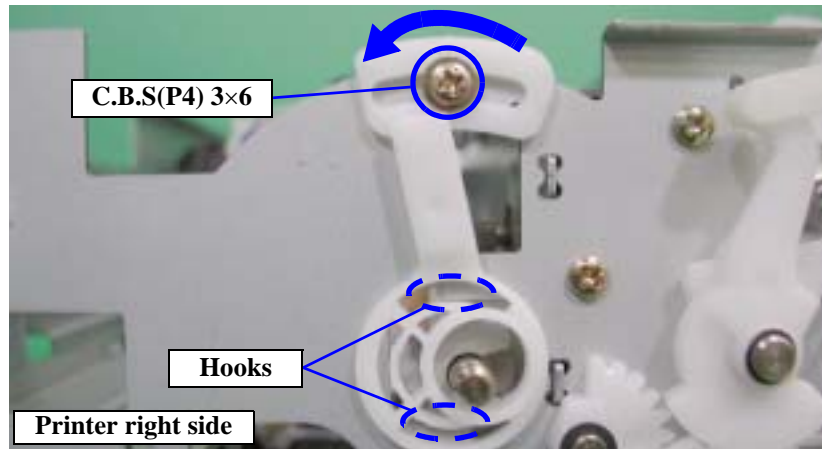


Figure 4-77. Removing the Right Adjust Parallelism Bush

15. Release the Shaft Fixing Plate (Right) from the joggle on the right of the Frame, and turn it to remove from the Carriage Guide Shaft A.

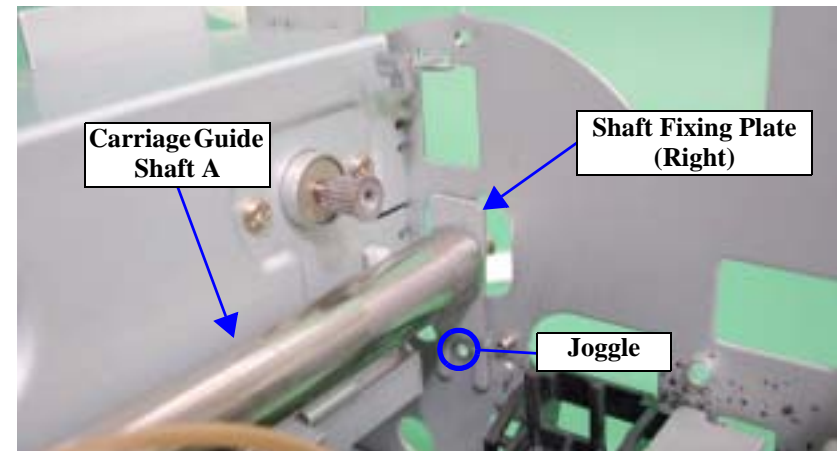


Figure 4-78. Removing the Shaft Fixing Plate (Right)

16. Slide the Carriage Guide Shaft A to the right as seen from the printer front to remove its left end from the Frame.

17. After facing the wider eccentric sides of the bearings on both ends of the Carriage Guide Shafts A and B toward the printer rear and front, respectively, to increase the distance between the Carriage Guide Shafts A and B, slightly lift the Carriage Unit and remove the Carriage Guide Shaft A to the diagonal top left of the Printer Mechanism.

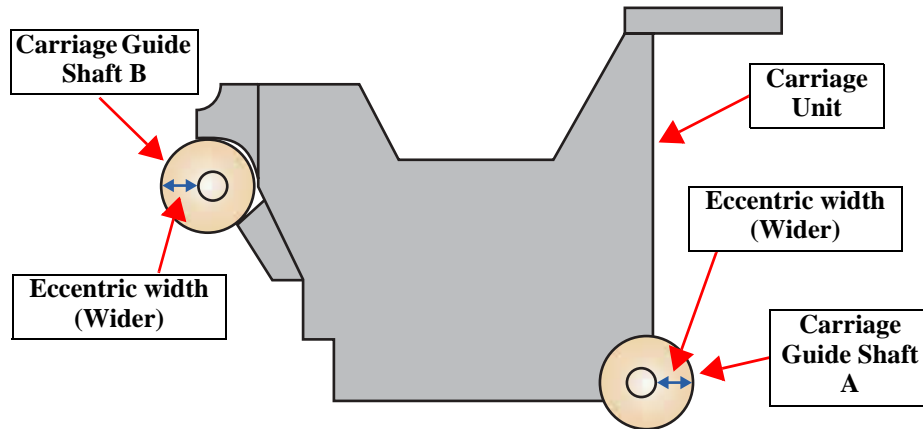


Figure 4-79. Removing the Carriage Unit and Carriage Guide Shaft A



■ When lifting the Carriage Unit, fully take care not to scratch the Carriage Guide Shaft B. Refer to Figure 4-79, "Removing the Carriage Unit and Carriage Guide Shaft A".



■ When removing the Carriage Guide Shaft A from the Carriage Unit, fully use care not to lose the Oil Pad at the lower rear of the Carriage Unit. Refer to Figure 4-80, "Oil Pad".

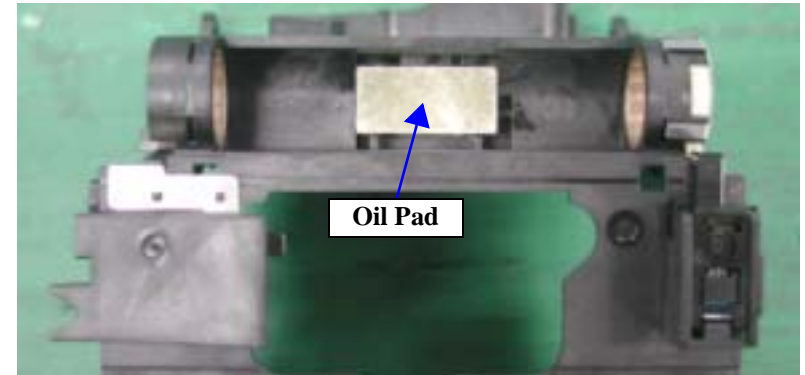


Figure 4-80. Oil Pad



■ Make sure that the left end of the Carriage Guide Shaft A is in order of the Bush, Shaft Fixing Plate (Left), Plain Spring and Leaf Spring. Refer to Figure 4-81, "Order on Left End of Carriage Guide Shaft A".

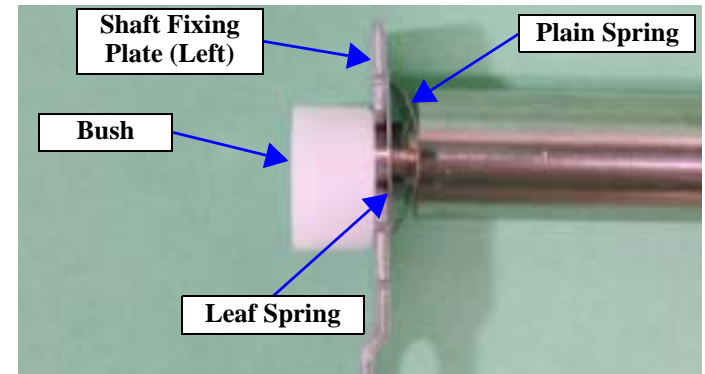


Figure 4-81. Order on Left End of Carriage Guide Shaft A



- When reinstalling the Shaft Fixing Plate to the Carriage Guide Shaft A, refer to Figure 4-82 since it will come off if reinstalled incorrectly. (As in the Carriage Guide Shaft B)

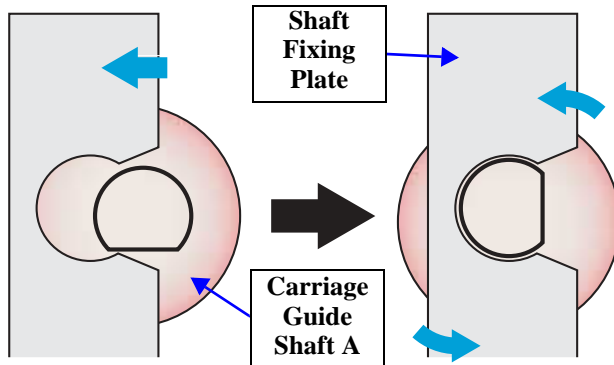


Figure 4-82. Reinstalling the Shaft Fixing Plate

- Reinstall the Carriage Unit and Carriage Guide Shaft A correctly so that the Timing Belt is not twisted.



- When removing the Carriage Unit, the following adjustments are necessary. Make the adjustments in the following order.
 1. PG adjustment
 2. CR tooth skip prevention mechanism adjustment
 3. Head cleanig
 4. Head angular adjustment
 5. Bi-D adjustment
 6. Pixel Shift Adjustment
- Refer to "Chapter 5 Adjustment" for the adjustment procedures.
- After changing the following parts for new ones, always apply grease G-26 or oil O-12 in the specified positions.
 - Driven Pulley Holder:
Refer to Chapter 6, Figure 6-4, "Lubrication Point 2".
 - Driven Pulley:
Refer to Chapter 6, Figure 6-5, "Lubrication Point 3".
 - Oil Pad, Oil Pad Ring:
Refer to "Chapter 6, Figure 6-14, "Lubrication Point 16".
 - Left Adjust Parallelism Bush:
Refer to Chapter 6, Figure 6-19, "Lubrication Point 21".
 - Right Adjust Parallelism Bush:
Refer to Chapter 6, Figure 6-20, "Lubrication Point 22".

4.2.10 Removing the Ink System Unit

CHECK
POINT



The Ink System Unit consists of the Cap Unit, Pump Unit and Head Cleaner.

1. Remove the Printer Mechanism. (Refer to 4.2.1.4.)
2. Move the Carriage Unit to the center.
3. Remove the four screws (6) C.B.S 3×6 (9±1kgf.cm) that secure the Ink System Unit.

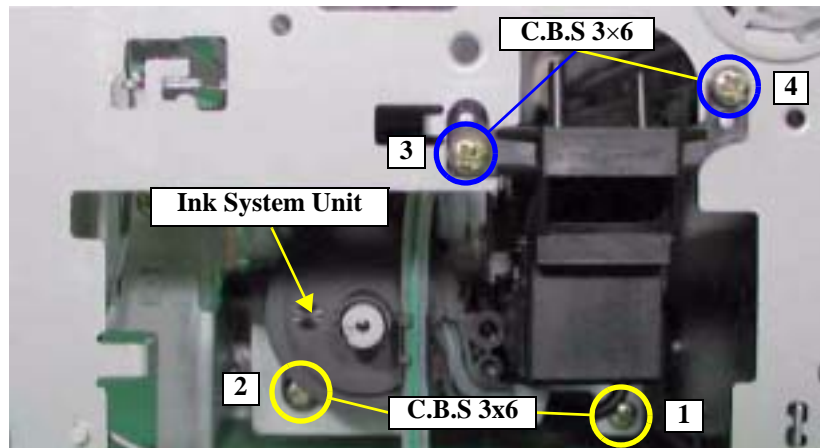


Figure 4-83. Removing the Ink System Unit

REASSEMBLY



Fit the screws (6) C.B.S 3×6 in the order shown in Figure 4-83.

4. Remove the three hooks, which secure the Cap Unit, from the I/S Frame, remove the one projection on the Head Cleaner side from the Cap Unit, remove the Ink Tube connection from the Pump Tube, and remove the Cap Unit.

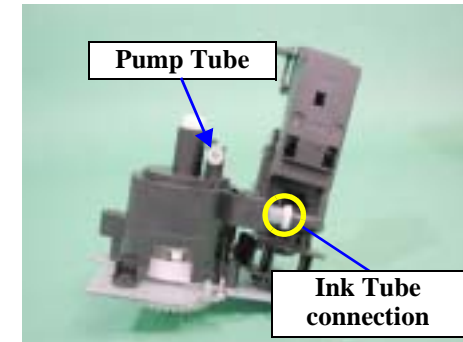
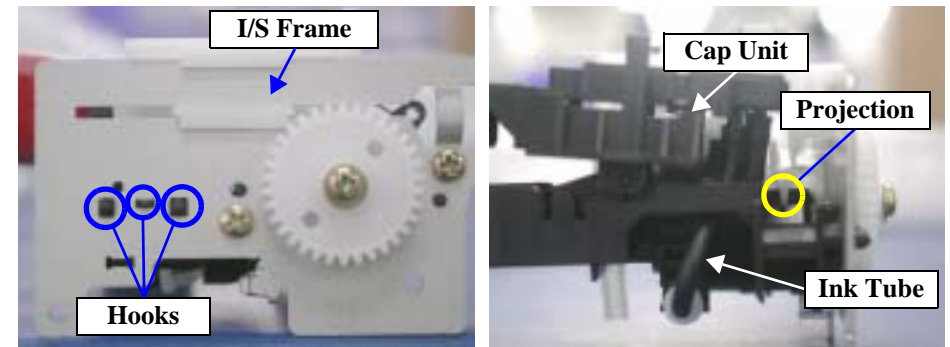


Figure 4-84. Removing the Cap Unit

CAUTION



When removing the Ink Tube from the Pump Tube, be careful of ink leakage.
Figure 4-84, "Removing the Cap Unit".

**CHECK
POINT**

When you remove the two screws that secure the Cap Unit and carry out Step 4, you can remove the Cap Unit without removing the Ink System Unit.

Refer to Figure 4-83, "Removing the Ink System Unit" and Figure 4-84, "Removing the Cap Unit".

4.2.11 Removing the Release Lever Shaft

1. Remove the Printer Mechanism. (Refer to 4.2.1.4.)
2. Remove the ASF Unit. (Refer to Steps 2 to 4 in 4.2.4.)
3. Move the Release Lever to the thick paper printing position, and remove the PG Change Spring Link from the PG Change Spring Lever.

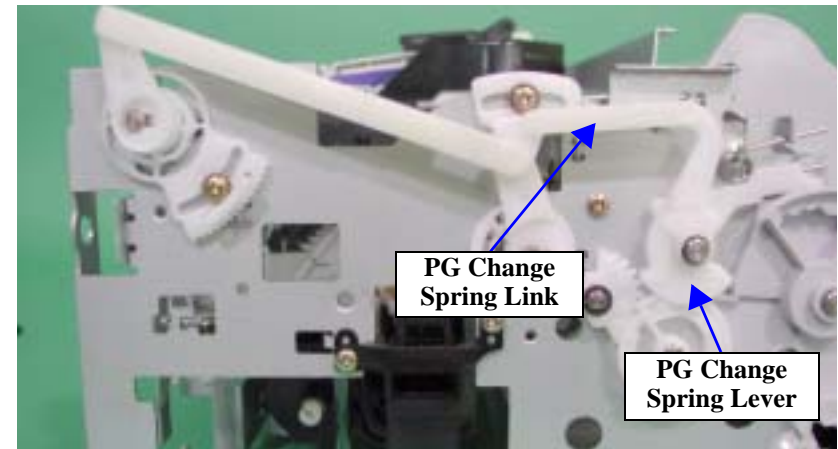


Figure 4-85. Removing the PG Change Spring Link

4. Before removing the PG Change Spring Lever and Release Connect Lever, remove the C Ring, and then remove the PG Change Spring Lever, Intermittent Gear 24, 30 and Release Connect Lever in this order.

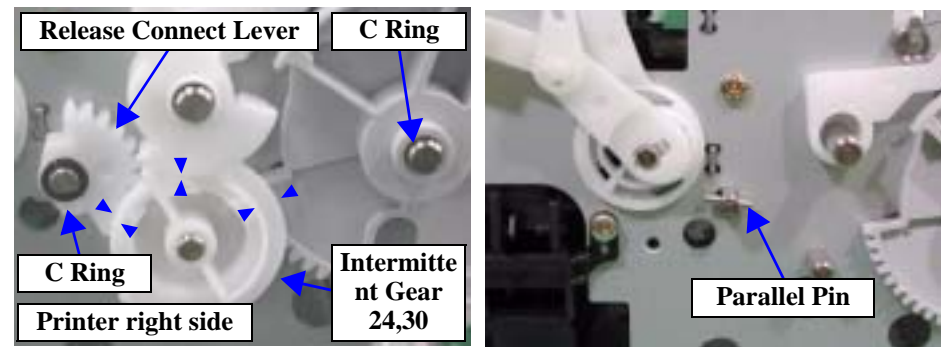


Figure 4-86. Removing the Gears



When reinstalling the PG Change Spring Lever, Intermittent Gear 24, 30 and Release Connect Lever, always match the phase marks that are also shown in the left photo in Figure 4-86.



The C Ring that secures the Release Connect Lever is larger than the C Ring that secures the PG Change Lever. Refer to Figure 4-86, "Removing the Gears".



When removing the Release Connect Lever, fully be careful not to lose the Parallel Pin since it may come off. Refer to Figure 4-86, "Removing the Gears".

- Remove the one screw 6) C.B.S 3×6 (9±1kgf.cm) that secures the Cover on the right end of the Release Lever Shaft as seen from the printer rear, pull the right end of the Cover to the front to release the hook on the left end of the Cover, and remove the Cover.

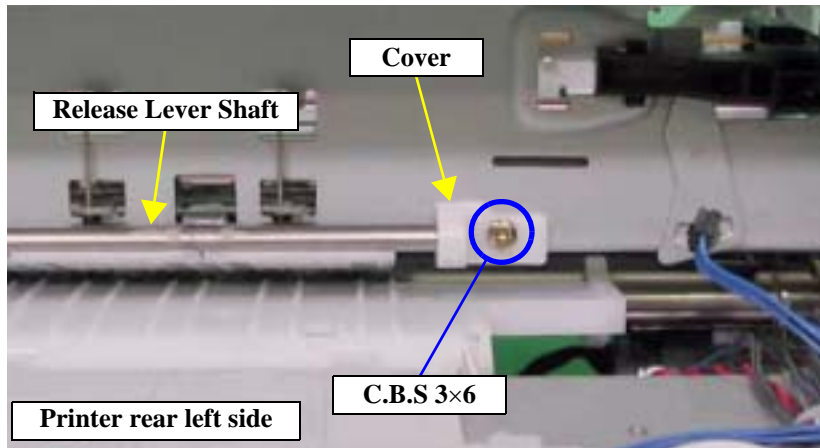


Figure 4-87. Removing the Cover

- Releasing the Torsion Springs 117.9 that secure the Driven Rollers as viewed from the printer rear disengages the Release Lever Shaft from the hooks on the Frame.

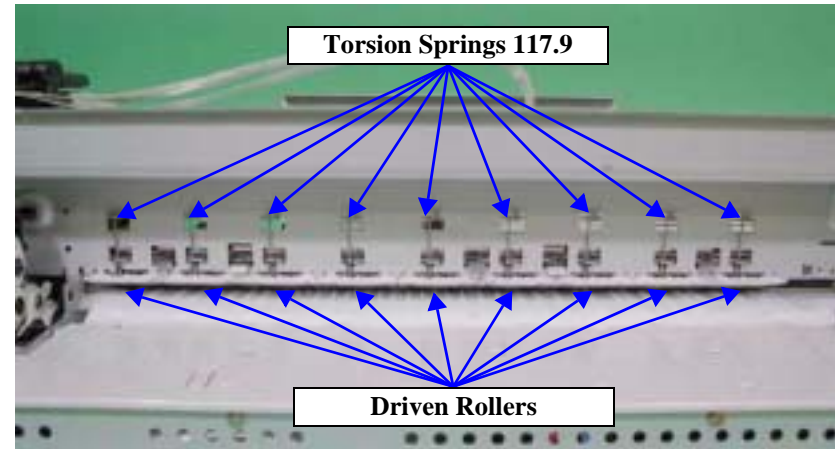


Figure 4-88. Releasing the Torsion Springs 117.9

- Pull the Release Lever Shaft to the right, as seen from the printer rear, to remove.



- When reinstalling the Release Lever Shaft, face the round part of its end downward, and then turn it counterclockwise to face the round part upward. Refer to Figure 4-89, "How to Install the Release Lever Shaft".

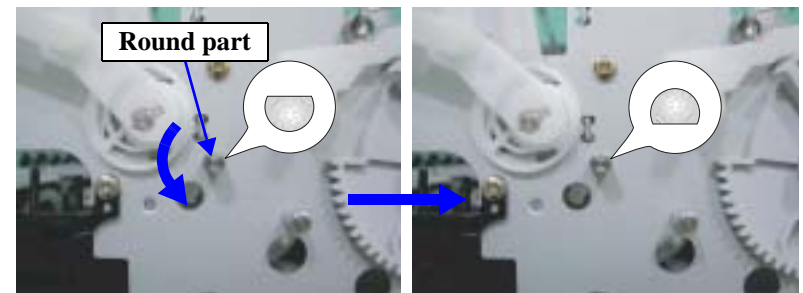


Figure 4-89. How to Install the Release Lever Shaft



- When reinstalling the Torsion Springs 117.9, make sure that the Torsion Springs 117.9 are placed correctly in the spring setting positions of the Driven Roller Assembly (printer front). Refer to Figure 4-90, "Torsion Spring 117.9 Setting Position".



Figure 4-90. Torsion Spring 117.9 Setting Position



- After changing the following parts for new ones, always apply grease G-26 in the specified positions.
 - Release Lever Shaft:
Refer to Chapter 6, Figure 6-11, "Lubrication Point 13".
 - Click Lever:
Refer to Chapter 6, Figure 6-16, "Lubrication Point 18".
 - Release Lever, Release Connect Lever, Intermittent Gear 24, 30:
Refer to Chapter 6, Figure 6-17, "Lubrication Point 19".

4.2.12 Removing the Sensors

4.2.12.1 Removing the PG Sensor and Release Sensor

- Remove the Rear Housing. (Refer to 4.2.1.2.)
- Disconnect the Connector Cables of the PG Sensor and Release Sensor from the Connectors of the PG Sensor and Release Sensor.
- Release the two hooks that secure each of the PG Sensor and Release Sensor, and remove the PG Sensor and Release Sensor.

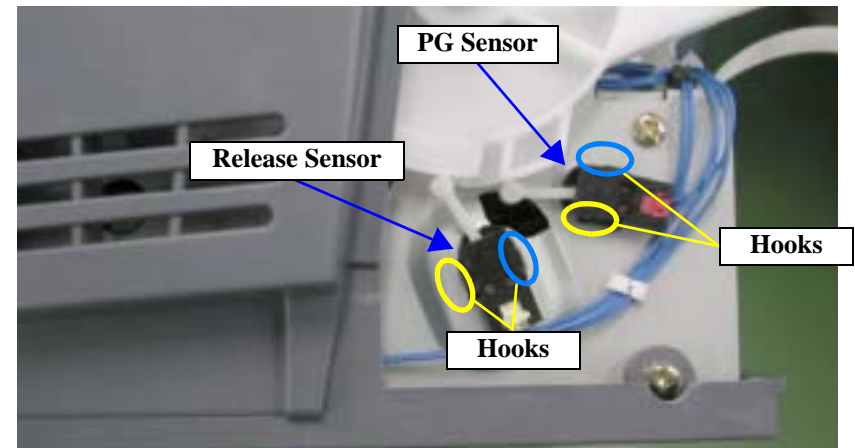


Figure 4-91. Removing the PG Sensor and Release Sensor



- When reinstalling the PG Sensor and Release Sensor, locate the PG Sensor Connector Cable end, which is read, in the top right position, and the Release Sensor Connector Cable end, which is yellow, in the bottom left position. Refer to Figure 4-91, "Removing the PG Sensor and Release Sensor".

4.2.12.2 Removing the ASF Sensor

1. Remove the ASF Unit. (Refer to 4.2.4.)
2. Remove the ASF Sensor Wheel of the ASF Unit. (Refer to Steps 5 to 8 in 4.2.4.1.)
3. Release the two hooks that secure the ASF Sensor with tweezers or a flat-head screwdriver, and slide and remove the ASF Sensor to the bottom left as seen from the left side of the ASF Unit.

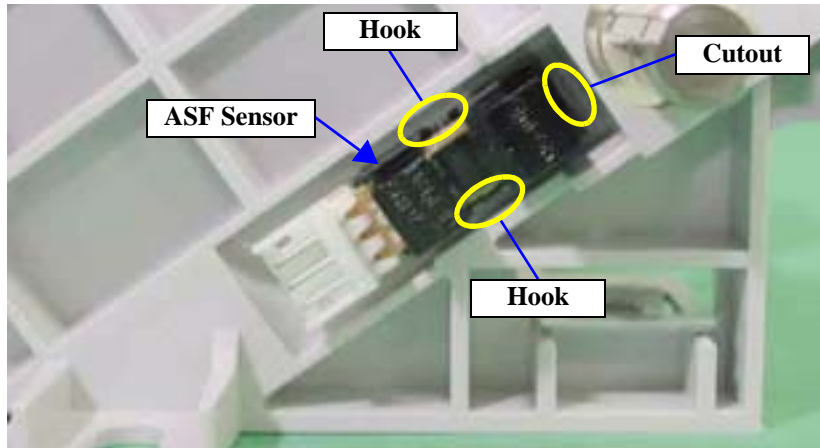


Figure 4-92. Removing the ASF Sensor



When reinstalling the ASF Sensor, first insert the cutout into the ASF Frame and push the two hooks in. Refer to Figure 4-92, "Removing the ASF Sensor".

4.2.12.3 Removing the PF Encoder Sensor

1. Remove the Rear Housing. (Refer to 4.2.1.2.)
2. Remove the Middle Housing. (Refer to 4.2.1.3.)
3. Release the one hook that secures the PF Encoder Frame to the Frame, and while extending the Lower Housing outward, remove the PF Encoder Frame.
4. Remove the FFC that is connected to the PF Encoder.

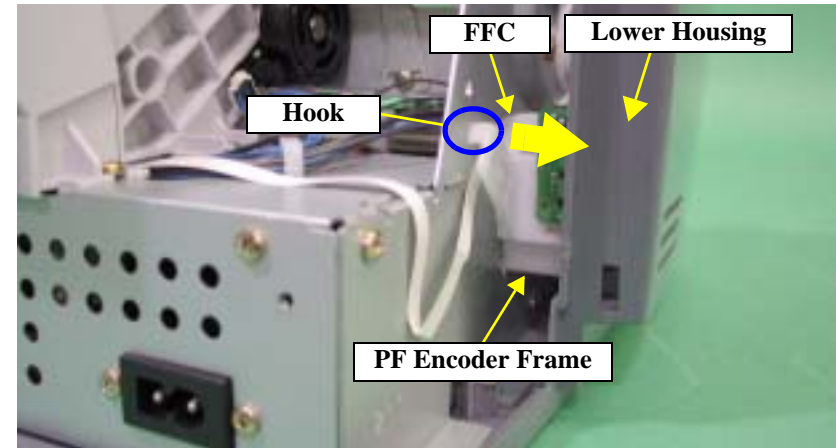


Figure 4-93. Removing the PF Encoder Frame

- Remove the one screw 11) C.B.P 2.5×5 (1.5±0.25kgf.cm) that secures the PF Encoder Sensor, and remove the PF Encoder Sensor.

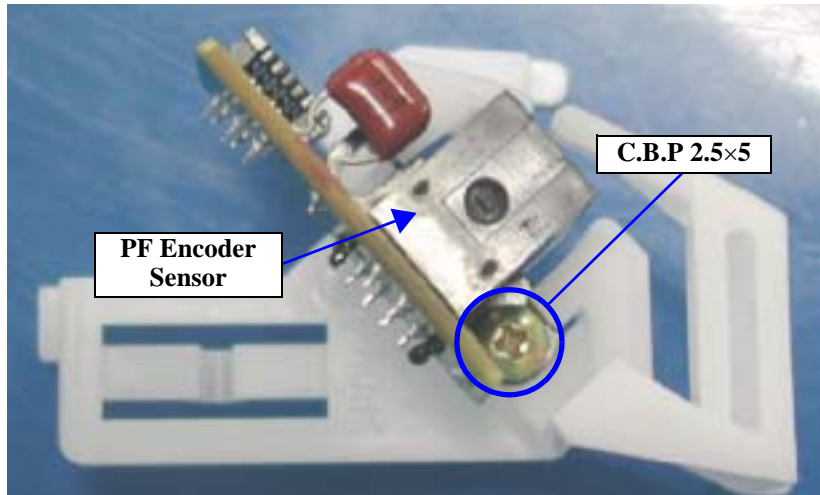


Figure 4-94. Removing the PF Encoder Sensor



- When reinstalling the PF Encoder Sensor, insert the two cutouts and then push the hook in. Refer to Figure 4-95, "Reinstalling the PF Encoder Sensor".
- Pass the FFC of the PF Encoder Sensor through under the Arm of the PF Encoder Sensor Frame. Refer to Figure 4-95, "Reinstalling the PF Encoder Sensor".



Figure 4-95. Reinstalling the PF Encoder Sensor

4.2.12.4 Removing the CD-R Sensor

- Remove the Front Frame. (Refer to Steps 1 to 7 in 4.2.5.)
- Release the two hooks that secure the CD-R Sensor, and remove the CD-R Sensor.

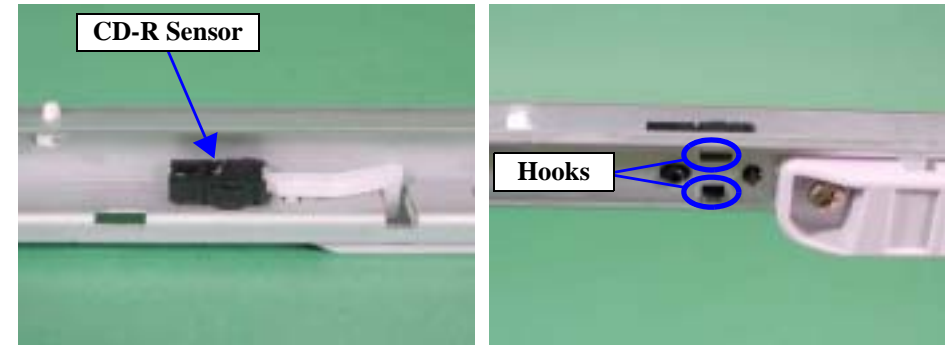


Figure 4-96. Removing the CD-R Sensor



- When connecting the Connector Cable to the CD-R Sensor, use tweezers and connect correctly. Refer to Figure 4-47, "Removing the Front Frame".
- Connect the CD-R Sensor Connector Cable with the Tie Wraps of the Front Frame correctly. Refer to Figure 4-47, "Removing the Front Frame".

4.2.12.5 Removing the PW Sensor

1. Remove the Carriage Unit. (Refer to 4.2.9.)
2. Release the hook of the PW Sensor Cover located on the Carriage Unit bottom, and slide and remove the PW Sensor Cover together with PW Sensor.

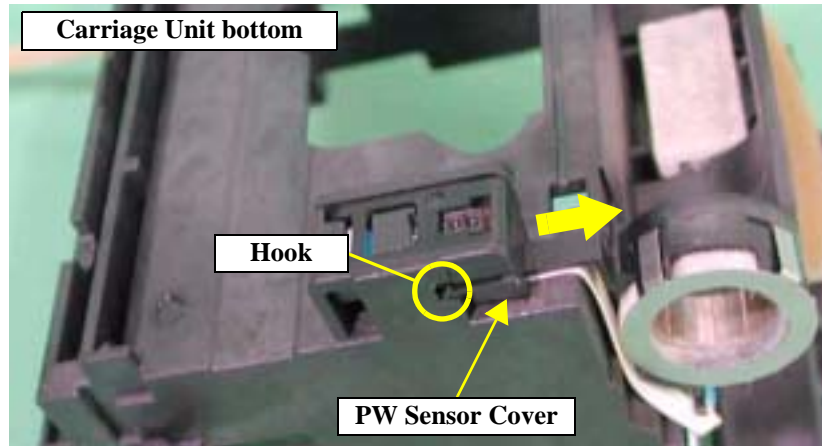


Figure 4-97. Removing the PW Sensor Cover

3. Disconnect the FFC connected to the PW Sensor.
4. Remove the PW Sensor from the PW Sensor Cover.

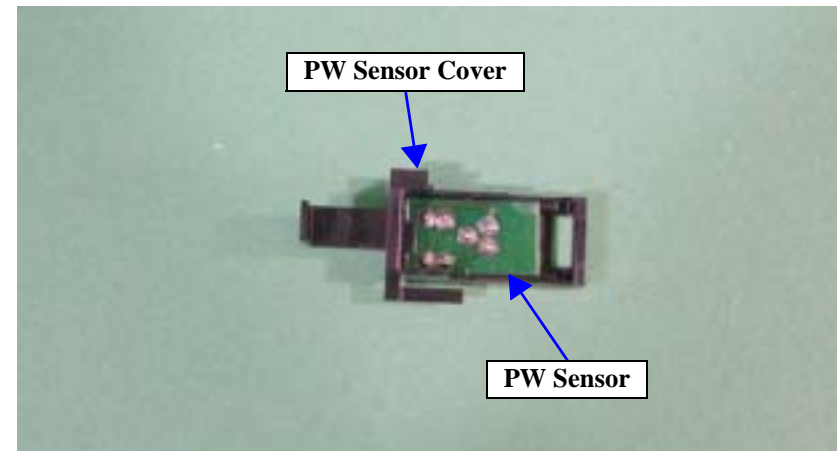


Figure 4-98. Removing the PW Sensor



- When reinstalling the PW Sensor, hitch it on the hook of the PW Sensor Cover. Refer to Figure 4-97, "Removing the PW Sensor Cover".
- Insert the FFC into the PW Sensor securely. Refer to Figure 4-99, "Removing the PW Sensor".

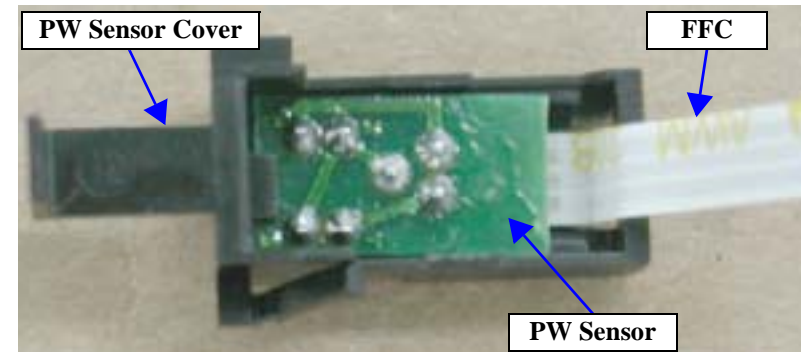


Figure 4-99. Removing the PW Sensor



To connect the FFC of the PW Sensor, pass it around the Arm of the PW Sensor Cover and the rear side of the Bearing on the left side (as seen from the printer front) of the Carriage Unit and into the hook on the rear left of the Carriage Unit, and return it between the hook and the Connector of the CR Encoder Sensor Board, and connect it to the Connector of the CR Encoder Sensor Board.

Refer to Figure 4-100, "Routing the FFC".

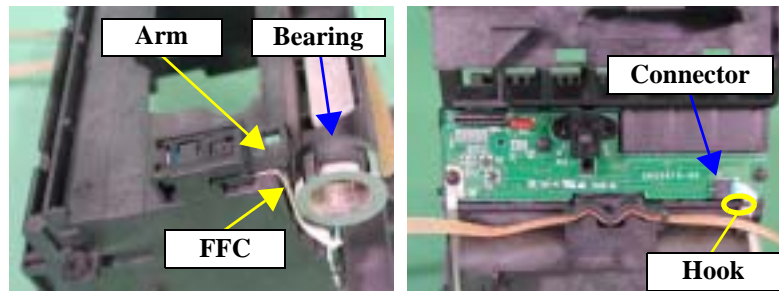


Figure 4-100. Routing the FFC



■ When removing or changing the PW Sensor, the following adjustments are necessary. Make the adjustments in the following order.

1. PG adjustment
2. CR tooth skip prevention mechanism adjustment
3. Head cleaning
4. Head angular adjustment
5. Bi-D adjustment
6. Pixel Shift Adjustment
7. PW sensor mounting position adjustment

■ Refer to "Chapter 5 Adjustment" for the adjustment procedures.

4.2.12.6 Removing the CR Encoder Sensor Board

1. Remove the Carriage Unit. (Refer to 4.2.9.)
2. Remove the three screws 12) C.P.B (P1) 1.7×5 (1.5±0.25kgf.cm) that secure the CR Encoder Sensor Board.
3. Disconnect the FFC, which is connected to the CR Encoder Sensor Board, from the Connector, and remove the CR Encoder Sensor Board.

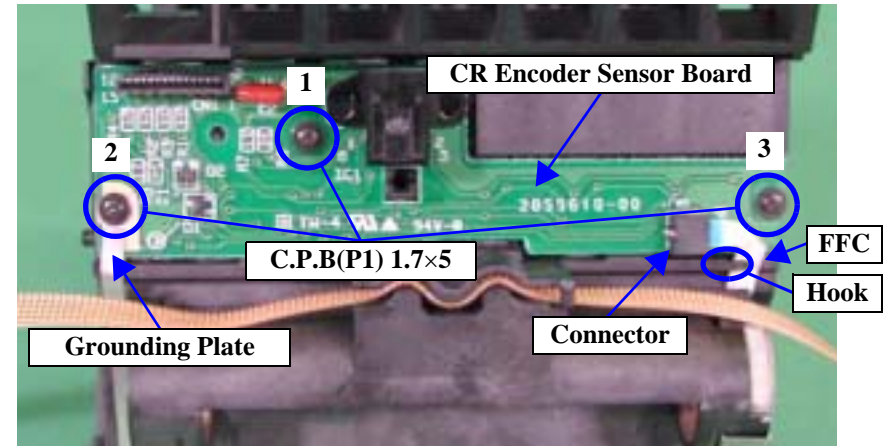


Figure 4-101. Removing the CR Encoder Sensor Board



- Fit the screws into the CR Encoder Sensor Board in the order shown in Figure 4-101.
- Before fitting the screw indicated by 2. in Figure 4-101, place the Grounding Plate on the Board.
- Reinstall the CR Encoder Sensor Board securely and evenly. Otherwise, when the Carriage Unit operates, the Driven Pulley and PW Sensor Connector will make contact with each other and there is a strong likelihood of operation fault occurrence. Refer to Figure 4-101, "Removing the CR Encoder Sensor Board".
- To connect the FFC to the Connector of the CR Encoder Sensor Board, always pass it around the rear side of the Bearing on the left side (as seen from the printer front) of the Carriage Unit and into the hook on the rear left of the Carriage Unit, and return it between the hook and the Connector of the CR Encoder Sensor Board, and connect it to the Connector of the CR Encoder Sensor Board. Refer to Figure 4-100, "Routing the FFC".



- When removing or changing the CR Encoder Sensor Board, the following adjustments are necessary. Make the adjustments in the following order.
 1. PG adjustment
 2. CR tooth skip prevention mechanism adjustment
 3. Head cleanig
 4. Head angular adjustment
 5. Bi-D adjustment
- Refer to "Chapter 5 Adjustment" for the adjustment procedures.

4.2.12.7 Removing the PE Sensor

1. Remove the Ink System Unit. (Refer to 4.2.10.)
2. Release the two hooks, which secure the PE Sheet, upward, and remove the PE Sheet.

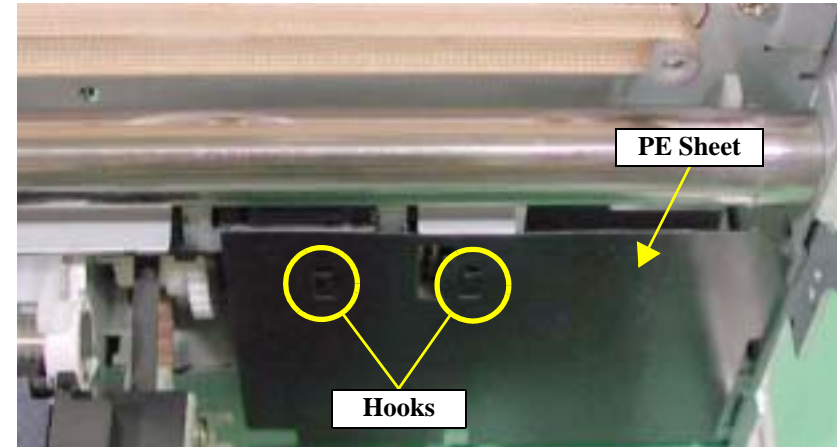


Figure 4-102. Removing the PE Sheet



Fully be careful when removing the PE Sheet since the Hook Supports of the PE Sheet are easily broken. Refer to Figure 4-102, "Removing the PE Sheet".

3. Remove the Release Lever Shaft from the hooks on the Frame. (Refer to Steps 5 and 6 in 4.2.11.)
4. Release the Torsion Springs 117.9 that secure the right-hand side Driven Rollers as seen from the printer rear, and while avoiding the PE Sensor Lever, pull the left-hand side Drive Rollers to the front to remove.
5. Release the two hooks that secure the PE Sensor Unit, and while avoiding the projection on the left side of the PE Lever, as seen from the printer front, from the Frame hook, remove the PE Sensor Unit to the bottom right as seen from the printer front.

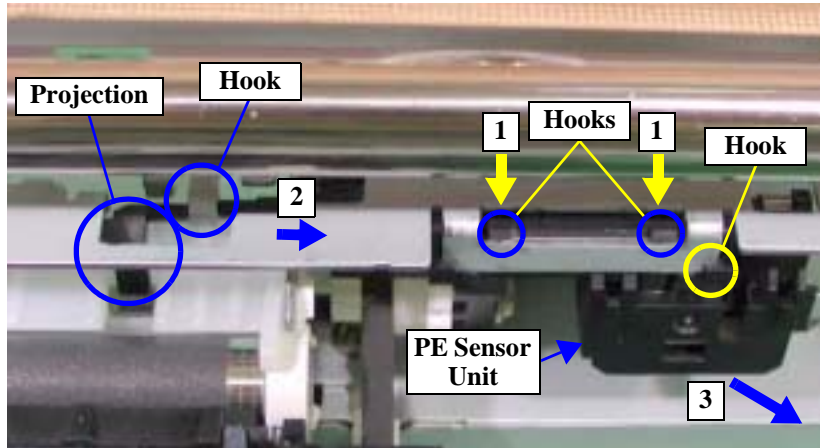


Figure 4-103. Removing the PE Sensor Unit



When reinstalling the PE Sensor Unit, secure it with three hooks. Refer to Figure 4-103, "Removing the PE Sensor Unit".

6. Disconnect the Connector Cables, which are connected to the PE Sensor, from the PE Sensor Connector and hook, and remove the PE Sensor Unit.
7. Release the PE Sensor Fixing Hook that secures the PE Sensor to the PE Sensor Unit, and remove the PE Sensor.

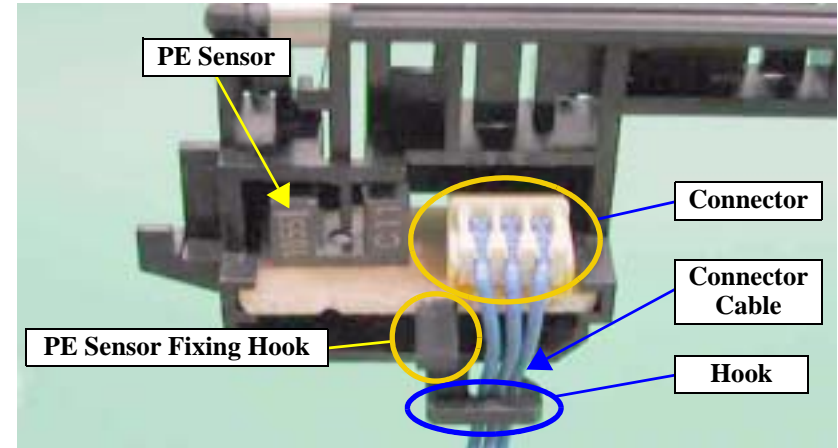


Figure 4-104. Removing the PE Sensor



When connecting the Connector to the PE Sensor, hitch the Connector Cables on the hook. Refer to Figure 4-104, "Removing the PE Sensor".

4.2.13 Removing the Motors

4.2.13.1 Removing the CR Motor

1. Remove the Middle Housing. (Refer to 4.2.1.3.)
2. Remove the ASF Unit. (Refer to 4.2.4.)
3. Release the two hooks that secure the Paper Guide Manual, and pull and remove the Paper Guide Manual to the front as viewed from the printer rear.

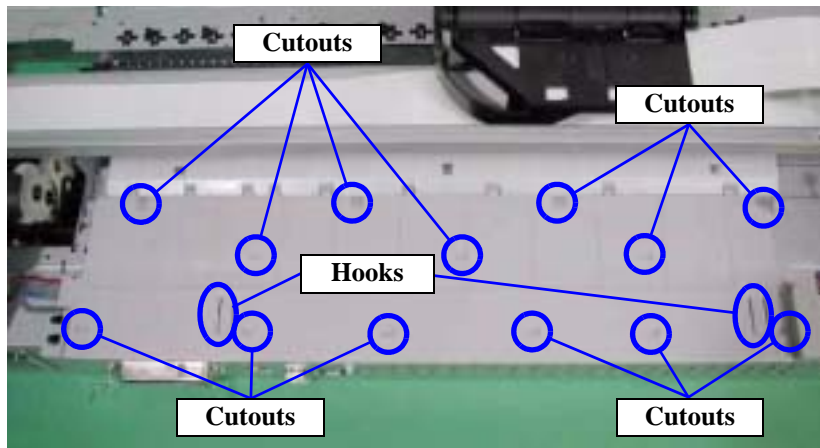


Figure 4-105. Removing the Paper Guide Manual



When reinstalling the Paper Guide Manual, securely insert the 13 cutouts into the Under Frame and fix the two hooks. When reinstalling the Paper Guide Manual, slide and push it from the printer rear to the front. Refer to Figure 4-105, "Removing the Paper Guide Manual".



Reinstall the Paper Guide Manual securely since the incorrectly (unevenly) mounted Paper Guide Manual will incur a paper feed fault in the manual feed mode. Refer to Figure 4-105, "Removing the Paper Guide Manual".

4. Release the two (a total of four) hooks, which secure each of the Harness Clamps to the Under Frame, with tweezers or a flat-blade screwdriver, and remove the two Harness Clamps from the Under Frame.
5. Release the Connector Cable of the CR Motor from the Tie Wrap.

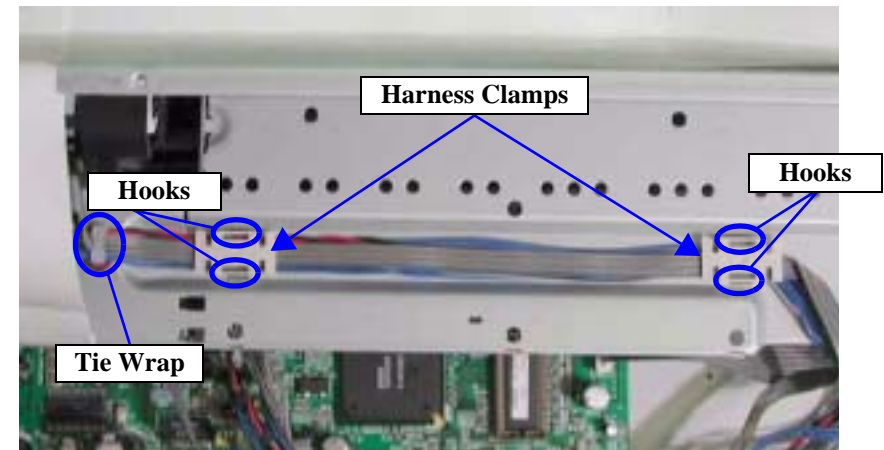


Figure 4-106. Releasing the CR Motor Cable

6. Disconnect the Connector Cable (CN17) of the CR Motor from the Main Board. (Refer to Steps 2 and 3 in 4.2.2.2.)
7. Remove the Timing Belt from the Pinion Gear of the CR Motor. (Refer to Steps 8 and 9 in 4.2.9.)

- 8. Remove the two screws 13) C.P.S 3×6 (6±1kgf.cm) that secure the CR Motor, and remove the CR Motor from the Upper Frame.

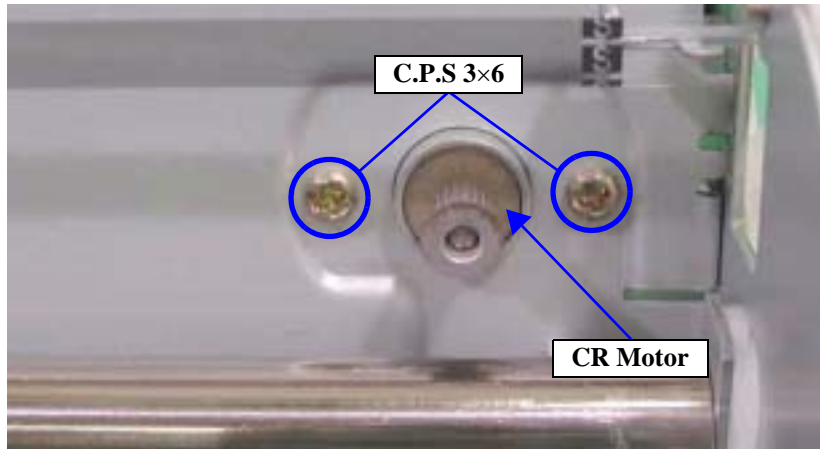


Figure 4-107. Removing the CR Motor



- When reinstalling the CR Motor, face the label of the CR Motor rightward as seen from the printer rear. Refer to Figure 4-108, "Installing the CR Motor".

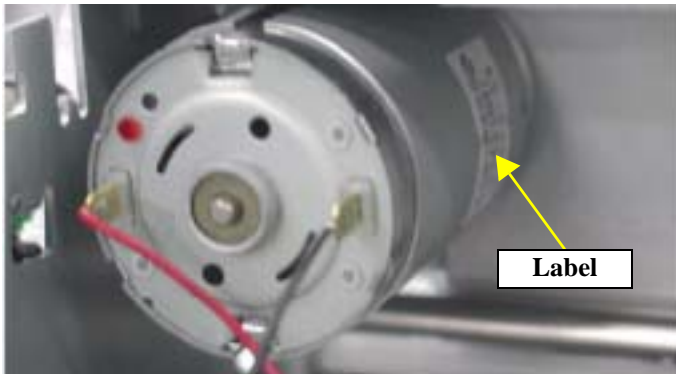


Figure 4-108. Installing the CR Motor

- After installing the CR Motor, fully use care not to damage the tooth surface of the Pinion Gear. Refer to Figure 4-107, "Removing the CR Motor".



- When changing the CR Motor, make sure that the Ferrite Core is fitted to the Cable securely.

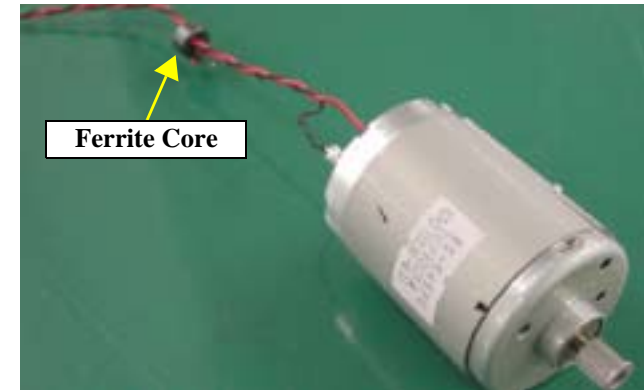


Figure 4-109. Checking the Ferrite Core



- When changing the CR Motor, the following adjustments are necessary. Make the adjustments in the following order.
 1. CR tooth skip prevention mechanism adjustment
 2. CR motor drive torque dispersion measurement (maximum correction value input)
- Refer to "Chapter 5 Adjustment" for the adjustment procedures.

4.2.13.2 Removing the PF Motor

1. Remove the Printer Mechanism. (Refer to 4.2.1.4.)
2. Remove the Paper Guide Manual. (Refer to Steps 2 and 3 in 4.2.13.1.)
3. Disconnect the Connector Cable (CN16) of the PF Motor from the Main Board. (Refer to Steps 2 and 3 in 4.2.2.2.)
4. Release the two hooks that secure the Harness Clamp to the Under Frame, and remove the Harness Clamp from the Under Frame.
5. Release the Cable of the PF Motor from the Tie Wrap.

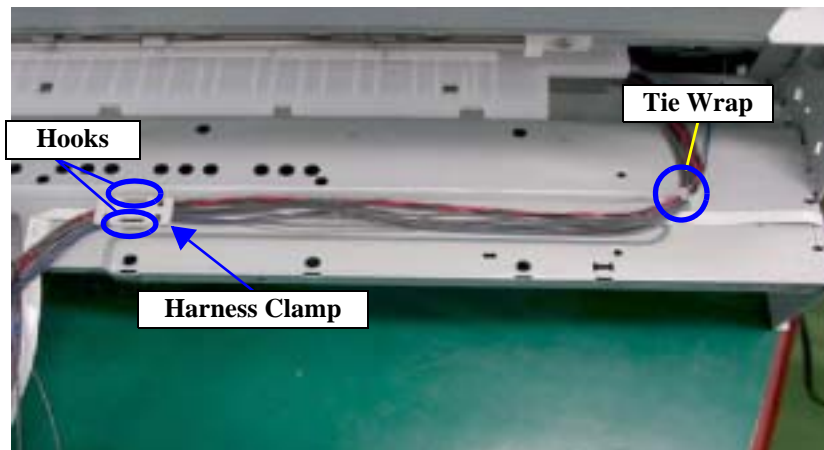


Figure 4-110. Releasing the PF Motor Cable

6. Remove the two screws 13) C.P.S 3×6 (6±1kgf.cm) that secure the PF Motor, and remove the PF Motor from the Left Frame.
When removing only the PF Motor, peel the PF Scale carefully (using care not to whiten it) and remove the PF Motor, since there are the Spur Gear 76 and PF Scale.

CAUTION



Fully be careful not to damage (whiten or break) the Spur Gear 76 tooth surface and PF Scale.

Refer to Figure 4-111, "Removing the PF Motor".

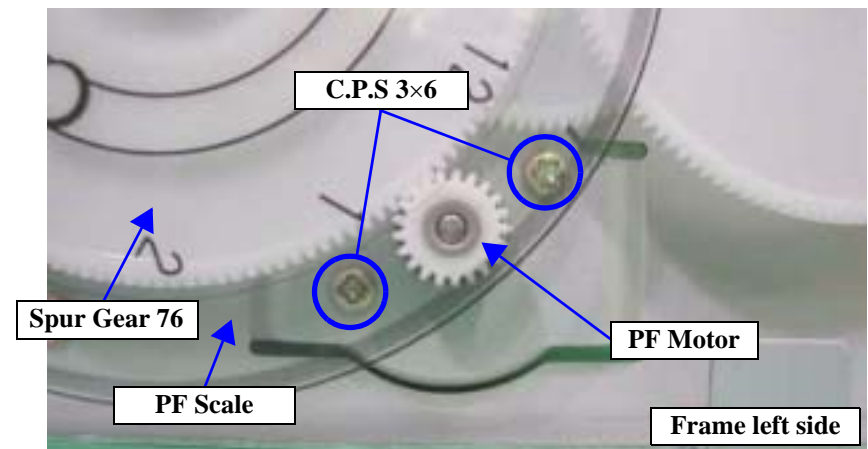


Figure 4-111. Removing the PF Motor



- When reinstalling the PF Motor, face the label of the PF Motor forward as seen from the printer front. Refer to Figure 4-112, "Installing the PF Motor".

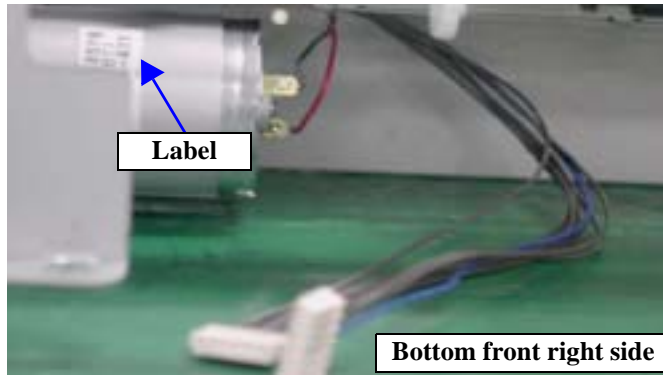


Figure 4-112. Installing the PF Motor

- When changing the PF Motor, make sure that the Ferrite Core is fitted to the Cable securely. Refer to Figure 4-113, "Checking the Ferrite Core".

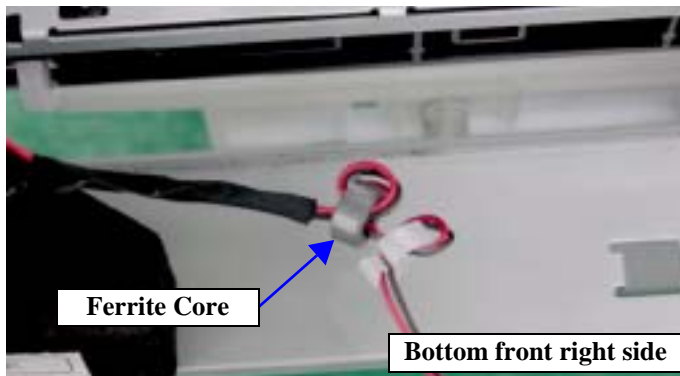


Figure 4-113. Checking the Ferrite Core

4.2.14 Removing the DE Unit and ASF/Pump Motor

1. Remove the PE Sensor Unit. (Refer to Steps 1 to 5 in 4.2.12.7.)
2. Using tweezers, remove the Extension Spring 0.618 that engages the DE Lock Lever and DE Unit.

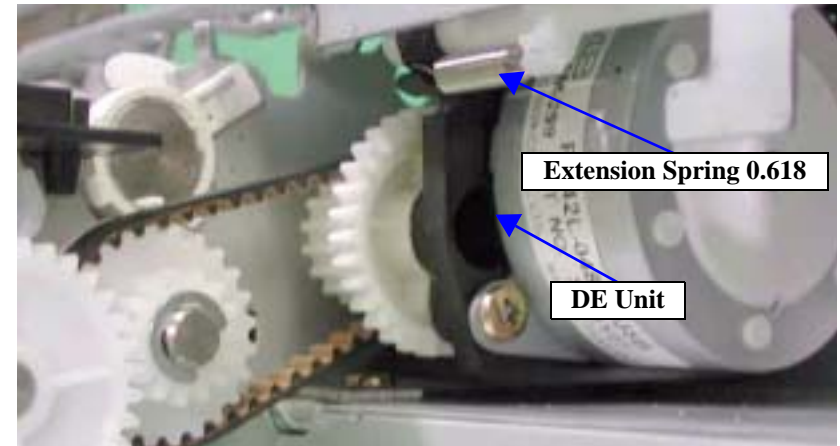


Figure 4-114. Removing the Extension Spring 0.618

- Release the one hook on the DE Unit (ASF Mounting Plate) that secures the DE Lock Lever, and slide the DE Lock Lever to the left as seen from the printer rear, to remove the right end of the DE Lock Lever from the DE Unit mounting hole, lower it, and pull it off to the right.

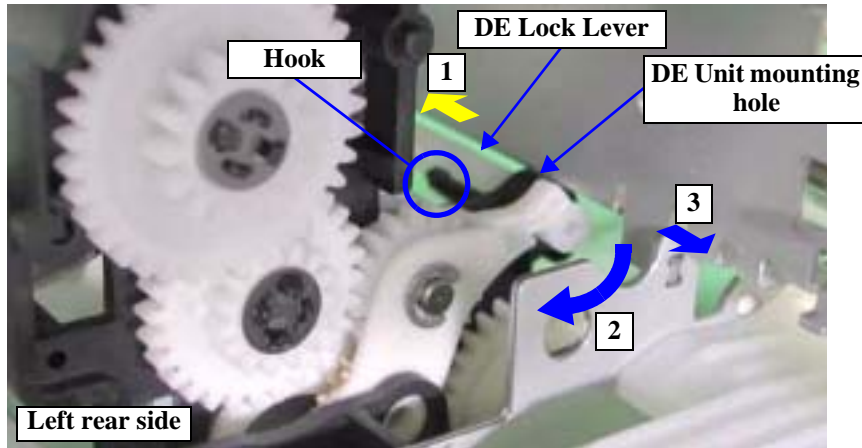


Figure 4-115. Removing the DE Lock Lever

- Release the one hook that secures the Spur Gear 26.4, and remove the Spur Gear 26.4 from the Under Frame.

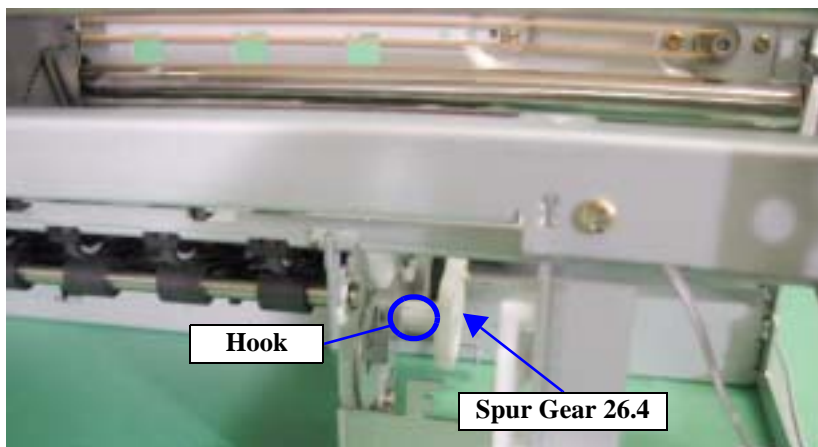


Figure 4-116. Removing the Spur Gear 26.4

- Loosen the one screw (6) C.B.S 3×6 (9±1kgf.cm) that secures the DE Unit Lever, remove the Extension Spring 9.27 that engages the Under Frame and DE Unit Lever, and remove the Timing Belt from the Combination Gear 12, 22.92.

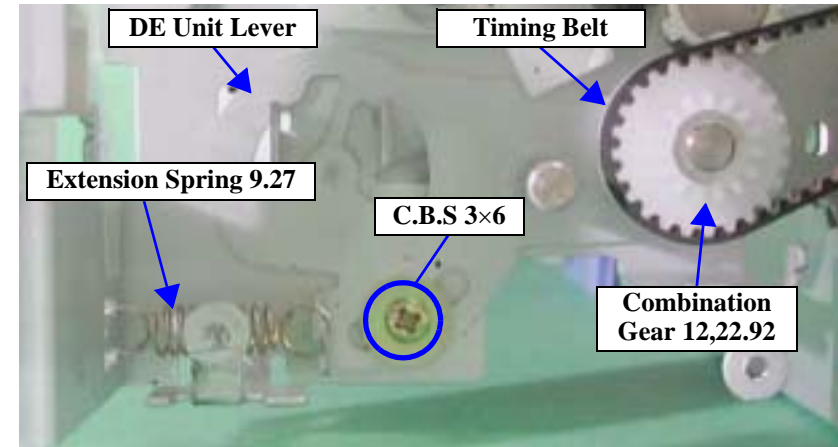


Figure 4-117. Removing the Timing Belt

- Remove the two Harness Clamps and release the Harness of the ASF/Pump Motor from the mini-clamps. (Refer to Steps 2 to 4 in 4.2.13.1.)
- Disconnect the Connector Cable (CN8) of the ASF/Pump Motor from the Main Board. (Refer to Steps 2 and 3 in 4.2.2.2.)

- Remove the Torsion Spring 7.13 that engages the DE Unit, ASF/Pump Motor and Under Frame.

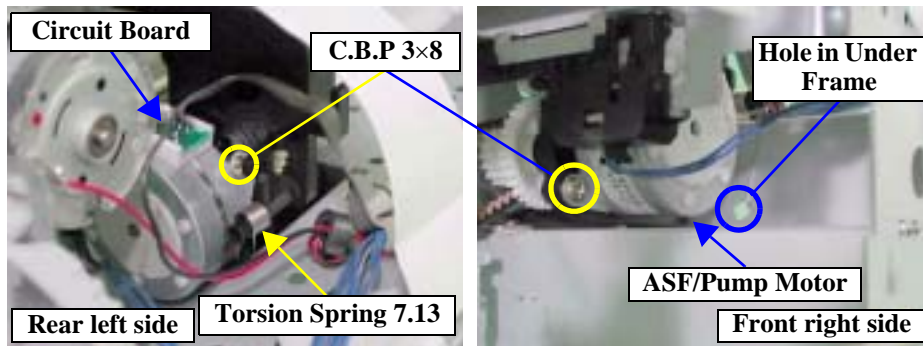


Figure 4-118. Removing the Torsion Spring 7.13



When reinstalling the Torsion Spring 7.13, bring the straight leg tip into contact with the ASF/Pump Motor, and hitch the other leg tip on the hole in the Under Frame. Refer to Figure 4-118, "Removing the Torsion Spring 7.13".

- Remove the one screw 6) C.B.S 3x6 (9±1kgf.cm) and one screw 14) C.B.P 3x8 (6±1kgf.cm) that secure the DE Unit.

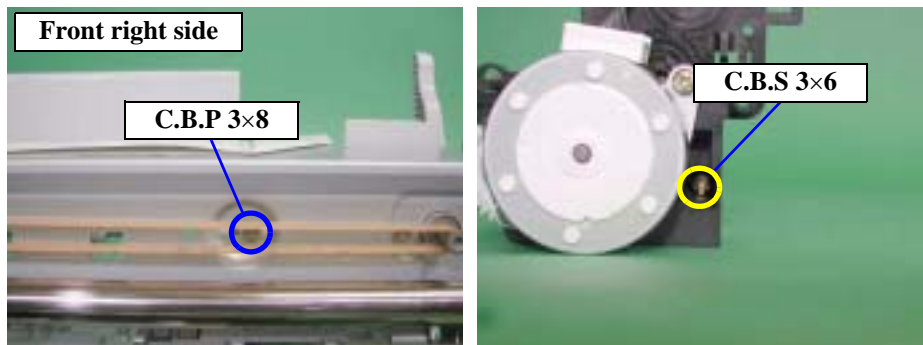


Figure 4-119. Screws That Secure the DE Unit

- Slide the DE Unit rear side to the printer left side as seen from the printer rear, pull off the DE Unit upper side to the front, and remove the DE Unit together with the ASF/Pump Motor.

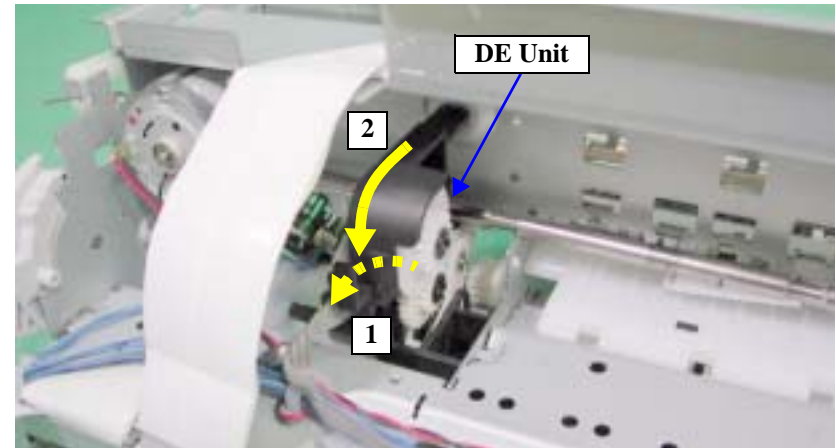


Figure 4-120. Removing the DE Unit

11. Remove the two screws 14) C.B.P 3×8 (6±1kgf.cm) that secure the ASF/Pump Motor.
12. Disconnect the Cable of the ASF/Pump Motor from the hook of the DE unit.
13. Slide the ASF/Pump Motor to the bottom right as seen from the DE Unit front to remove it from the DE Unit. (The DE Unit is also removed.)

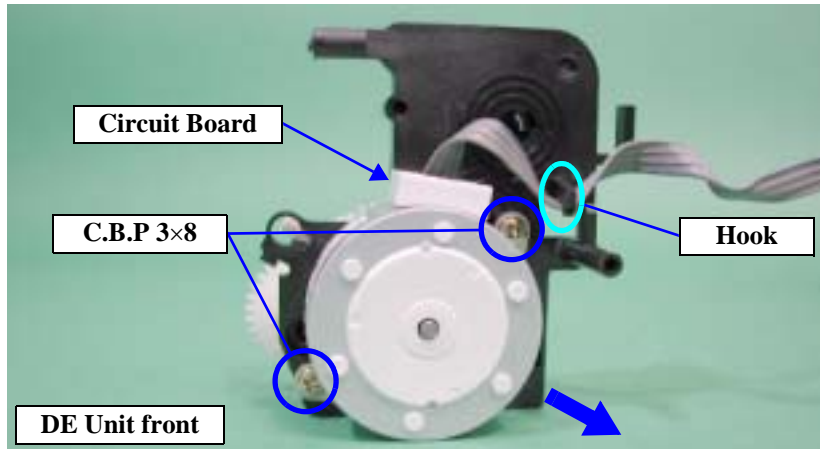


Figure 4-121. Screws That Secure the ASF/Pump Motor



- When reinstalling the ASF/Pump Motor, face the Circuit Board of the Motor upward.
Refer to Figure 4-121, "Screws That Secure the ASF/Pump Motor".
- To reinstall the ASF/Pump Motor to the DE Unit, lower the Planetary Lever Unit, insert the Pinion Gear of the ASF/Pump Motor into the ASF/Pump Motor positioning hole, and slide it to the top left side.
Refer to Figure 4-122, "How to Install the ASF/Pump Motor".

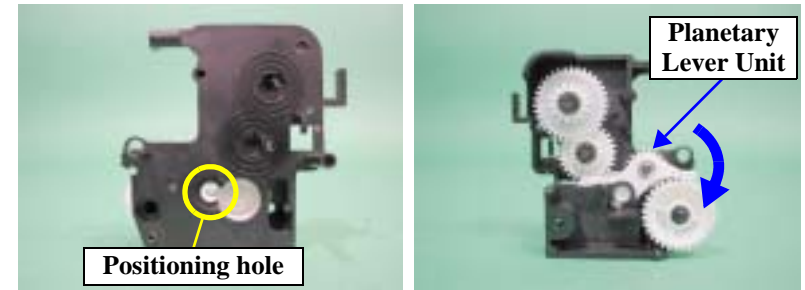


Figure 4-122. How to Install the ASF/Pump Motor



- After changing the following parts for new ones, always apply grease G-26 or oil O-12 in the specified positions.
 - Combination Gear 12, 22.4, Combination Gear 14, 28, ASF Motor Mounting Plate, Felt D3.6:
Refer to Chapter 6, Figure 6-6, "Lubrication Point 4, 5, 6, 7, 8".
 - Spur Gear 26.4, Compound Gear Lever Assembly:
Refer to Chapter 6, Figure 6-13, "Lubrication Point 15".

4.2.15 Removing the PF Roller

1. Remove the Paper Eject Roller Shaft B. (Refer to 4.2.6.)
2. Remove the Carriage Unit. (Refer to 4.2.9.)
3. Release the three hooks, which secure the front side of the Front Paper Guide as seen from the printer front, from the Paper Eject Roller Shaft A, and while lightly pulling the Front Paper Guide to the front, turn it upward to release the rear left side hook of the Front Paper Guide, and remove the Front Paper Guide.

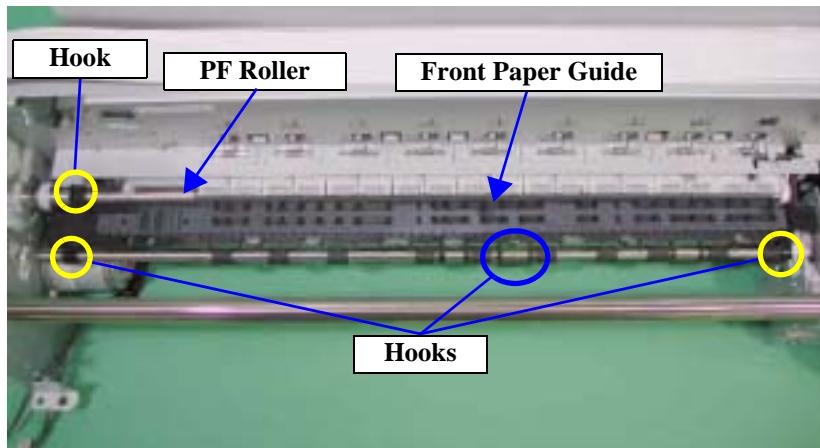


Figure 4-123. Removing the Front Paper Guide



Fully be careful when removing the Front Paper Guide, since the paper loading accuracy will reduce if the coating on the PF Roller surface peels off. This also applies to reinstallation. Refer to Figure 4-123, "Removing the Front Paper Guide".



Bring the Grounding Plate, which is located on the bottom right side of the Front Paper Guide as seen from the printer front, into contact with the Frame in advance.

Refer to Figure 4-124, "Position of the Grounding Plate".

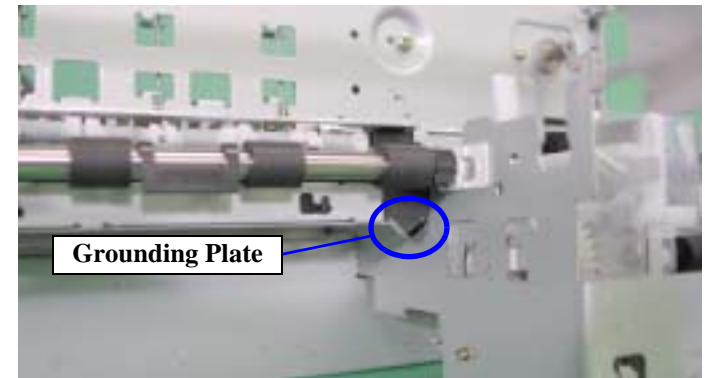


Figure 4-124. Position of the Grounding Plate

4. Release the three hooks, which secure the Rear Paper Guide as seen from the printer rear, from the Under Frame, release the two hooks that engages with the PF Roller, and remove the Rear Paper Guide.

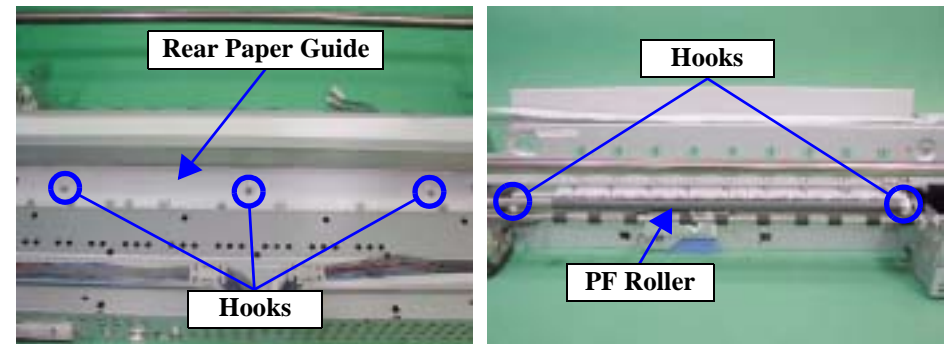


Figure 4-125. Removing the Rear Paper Guide



- Place the two Compression Springs 0.65, which are located on the lower side of the Rear Paper Guide as seen from the printer rear, into the recesses of the Under Frame, and reinstall the Rear Paper Guide.
Refer to Figure 4-126, "Positions of the Compression Springs 0.65".

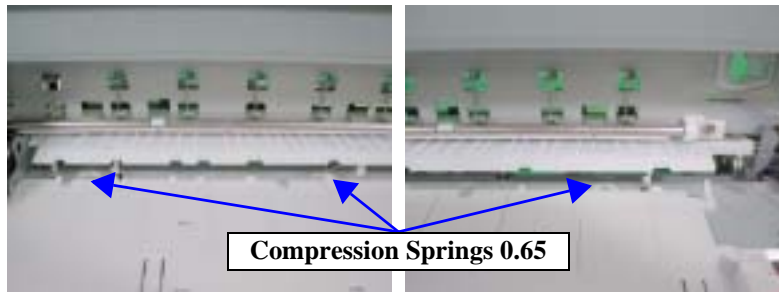


Figure 4-126. Positions of the Compression Springs 0.65

- Securely fitted into the joggles on the left and right lower sides of the Rear Paper Guide, the Compression Springs 0.65 are designed to be difficult to come off. If they have come off, however, securely insert them into the joggles on the lower side of the Rear Paper Guide.
Refer to Figure 4-126, "Positions of the Compression Springs 0.65".



When removing and reinstalling the Rear Paper Guide, also be fully careful not to peel off the coating of the PF Roller.
Refer to Figure 4-123, "Removing the Front Paper Guide".

- In order not to bring the Driven Roller and PF Roller surface into contact with each other, place the Release Lever in the far position.

- Remove the Extension Spring 9.65 from the PF Roller Support.

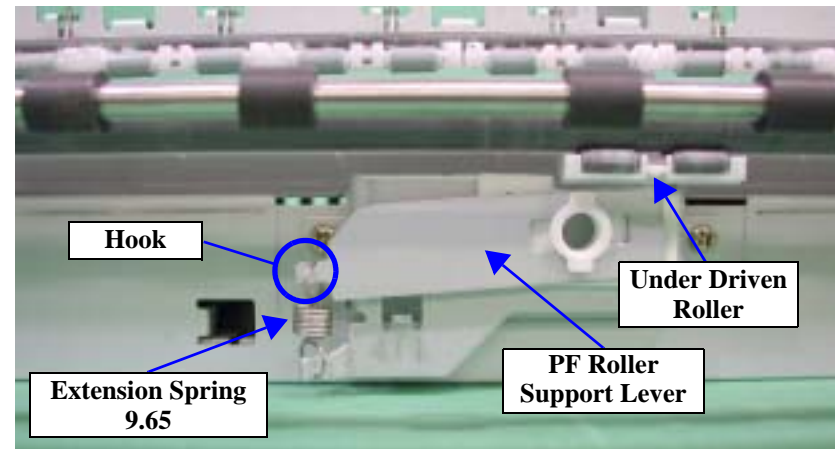


Figure 4-127. Removing the Extension Spring 9.65

- Remove the Grounding Spring that engages the PF Roller and Rear Frame.
- Release the joggle of the Bush 12 from the Left Frame, and after turning it to the front as seen from the printer front, slide the PF Roller to the left.

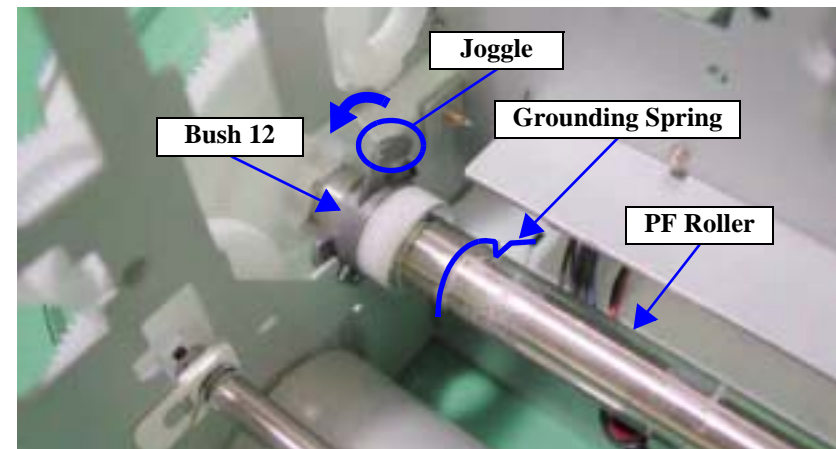


Figure 4-128. Removing the PF Roller



- Since the joggle of the Bush 12 is easily damaged, fully be careful when removing and reinstalling it. Refer to Figure 4-128, "Removing the PF Roller".
- When sliding the PF Roller, fully take care so that the coating of the PF Roller is not peeled off by the Lower Driven Roller and by the hook on the left side of the PF Roller Support Lever as seen from the printer front. Refer to Figure 4-127, "Removing the Extension Spring 9.65".

9. After sliding the PF Roller to the top front as viewed from the printer front, lift and remove it from the Left Frame.



- When removing the PF Roller, fully be careful not to scratch the PF Loop Scale. Refer to Figure 4-128, "Removing the PF Roller".
- When handling the PF Roller, wear gloves since the paper loading accuracy will decline if you touch its surface directly with bare hands. Refer to Figure 4-128, "Removing the PF Roller".
- When cleaning the surface, use a soft, clean brush. Refer to Figure 4-128, "Removing the PF Roller".



In the ASP structure, the PF Roller Unit consists of the PF Roller and Spur Gear 76 (including the Bush 12) and does not include the PF Scale. Place an order for the PF Scale as required.



- When changing the PF Roller, the following adjustments are necessary. Make the adjustments in the following order.
 1. PG adjustment
 2. CR tooth skip prevention mechanism adjustment
 3. Head cleaning
 4. Head angular adjustment
 5. Bi-D adjustment
 6. PF adjustment
- Refer to "Chapter 5 Adjustment" for the adjustment procedures.
- After changing the following parts for new ones, always apply grease G-26 in the specified positions.
 - Bush 12 (Right): Refer to Chapter 6, Figure 6-3, "Lubrication Point 1".
 - Rear Paper Guide: Refer to Chapter 6, Figure 6-8, "Lubrication Point 10".
 - PF Roller and PF Grounding Spring: Refer to Chapter 6, Figure 6-8, "Lubrication Point 10".
 - Front Paper Guide: Refer to Chapter 6, Figure 6-12, "Lubrication Point 14".

4.2.15.1 Reinstalling the PF Scale

This section explains the procedure for reinstalling the following parts.

- PF Scale (Loop Scale)
- Scale Mounting Plate
- D50 Tape (double-faced tape)

1. Apply the D50 Tape to the PF Scale.

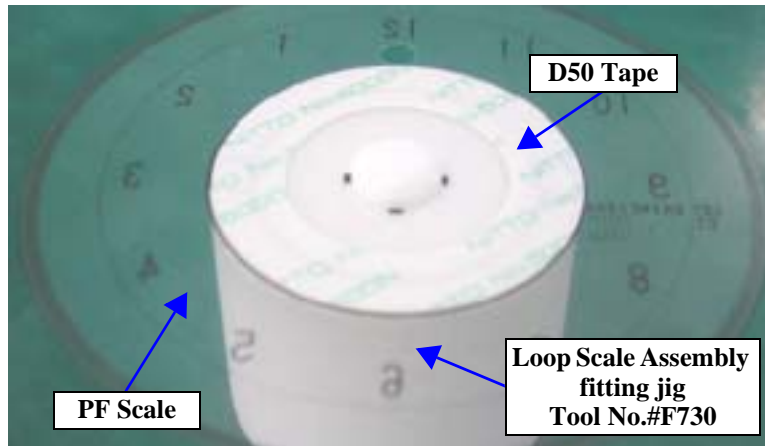


Figure 4-129. Peeling the Protective Sheet

CAUTION



The D50 Tape should match the outline of the printed circle. Refer to Figure 4-129, "Peeling the Protective Sheet".

2. After matching the round holes of the PF Scale with the projections of the Spur Gear 76, insert the PF Scale so that it is in parallel with the Spur Gear 76. At this point, do not apply the PF Scale to the Spur Gear 76.
3. Using the PF Scale Mounting Jig (AS-Tool No. 1051767), apply the PF Scale to the Spur Gear 76.

CAUTION



When applying the PF Scale to the Spur Gear 76, slowly apply it so that its inner diameter is not damaged.

If the inner diameter of the PF Scale is scratched and the PF Scale become eccentric, the paper loading accuracy will decline. Refer to Figure 4-130, "Applying the PF Scale".

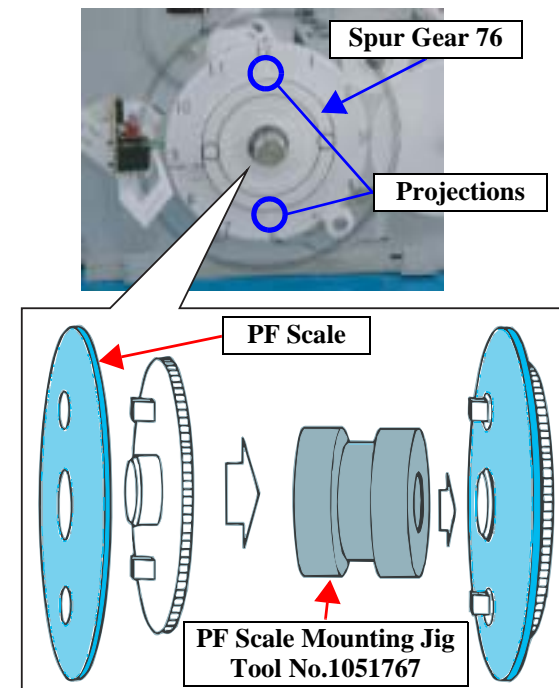


Figure 4-130. Applying the PF Scale

CHECK
POINT

- The two projections of the Spur Gear 76 should come out of the round holes of the PF Scale.
Refer to Figure 4-130, "Applying the PF Scale".
- Make sure that the PF Scale is not dirty and is free from scratches.
Refer to Figure 4-130, "Applying the PF Scale".

4.2.16 Removing the Paper Eject Roller Shaft A

1. Remove the PF Roller. (Refer to 4.2.15.)
2. Remove the C Ring that secures the Combination Gear 17, 24.5 of the Left Frame, and remove the Combination Gear 17, 24.5 from the Left Frame.
3. Remove the C Ring that secures the Spur Gear 43, and remove the Spur Gear 43 from the Paper Eject Roller Shaft A.

REASSEMBLY



- Since the Spur Gear A is a precision gear, change it for a new one once it has been removed.
Refer to Figure 4-131, "Removing the Combination Gear 17, 24.5 and Spur Gear 43".
- When reinstalling the Spur Gear 43 to the Paper Eject Roller Shaft A, hold the center of the Spur Gear 43 and install the Spur Gear 43 to the Paper Eject Roller Shaft A carefully. If you hold the periphery of the Spur Gear 43 to mount the Gear, the Gear will be deformed, reducing the paper loading accuracy. For reinstallation, it is recommended to press-fit the Spur Gear 43 using the PF Scale Mounting Jig, Tool No. 1051767.
Refer to Figure 4-131, "Removing the Combination Gear 17, 24.5 and Spur Gear 43".

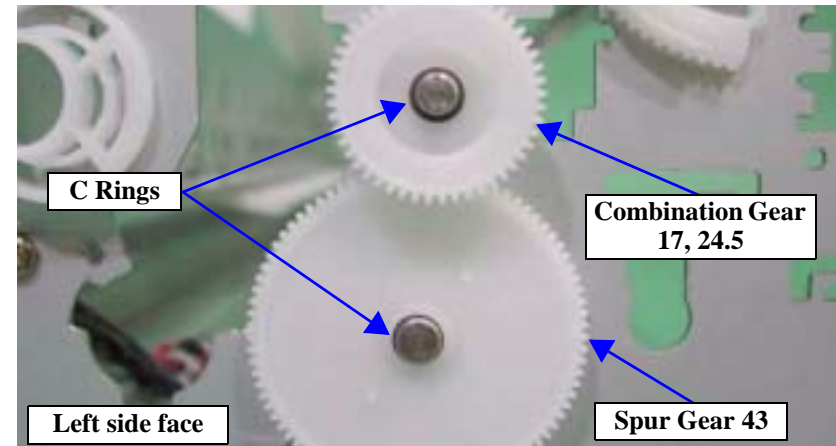


Figure 4-131. Removing the Combination Gear 17, 24.5 and Spur Gear 43

- Remove the Grounding Spring that engages the Paper Eject Roller Shaft A and Left Frame.

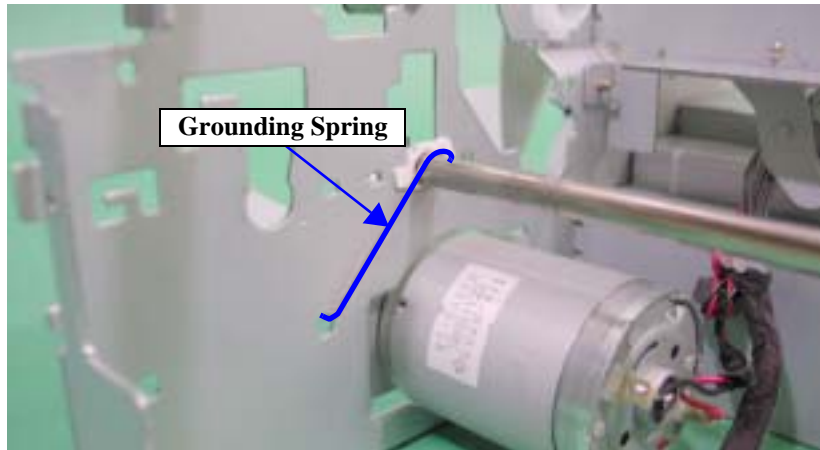


Figure 4-132. Removing the Grounding Spring

- Release the hooks of the Bushes 6, which are located on the left and right of the Paper Eject Roller Shaft A, from the Left and Right Frames, and turn the Bushes 6 to the rear as seen from the printer front.

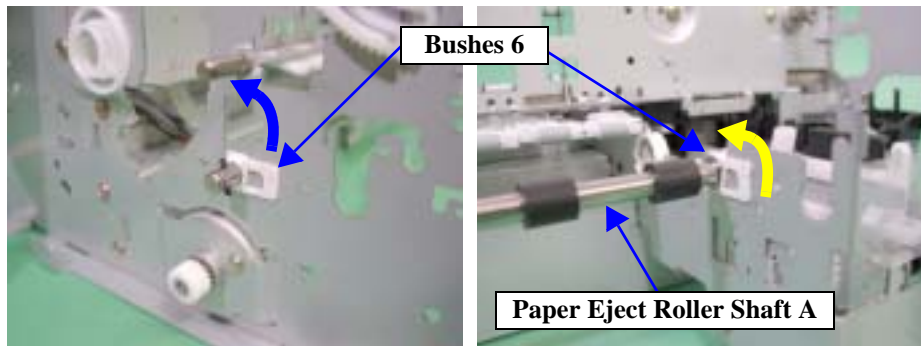


Figure 4-133. Releasing the Bushes 6

- After lifting the Paper Eject Roller Shaft A up as viewed from the printer front, release the left side Bush 6 from the Left Frame, and pull and remove the Paper Eject Roller Shaft A to the diagonal top right.

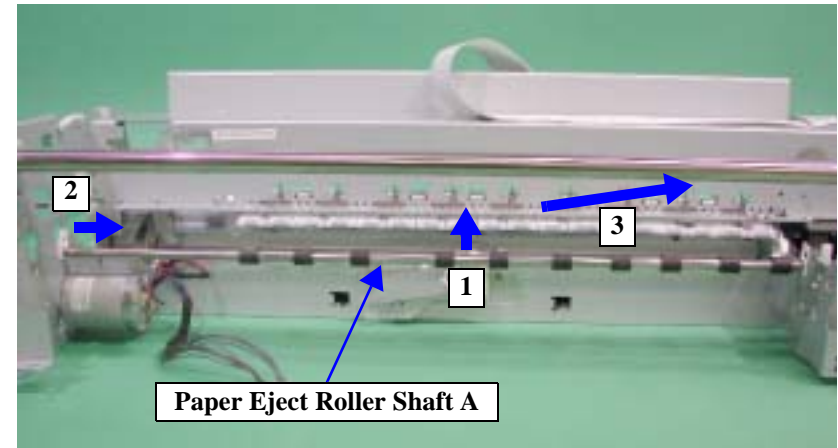


Figure 4-134. Removing the Paper Eject Roller Shaft A



When mounting the Carriage Lock Lever located on the right of the Paper Eject Roller Shaft A as viewed from the printer front, face its L-shaped leg frontward. Refer to Figure 4-135, "Orientation of Mounting the Carriage Lock Lever".

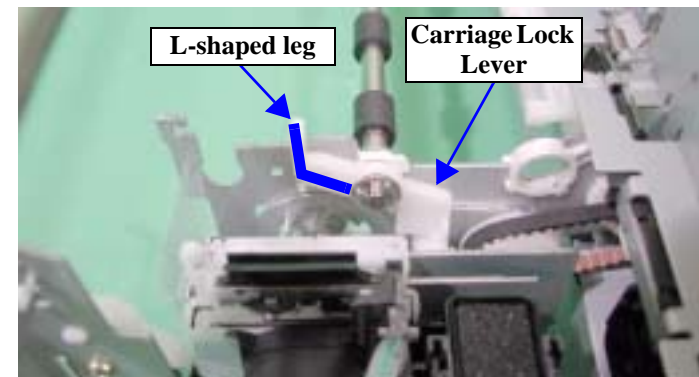


Figure 4-135. Orientation of Mounting the Carriage Lock Lever



- When removing the Paper Eject Roller Shaft A, the following adjustments are necessary. Make the adjustments in the following order.
 1. PG adjustment
 2. CR tooth skip prevention mechanism adjustment
 3. Head cleanig
 4. Head angular adjustment
 5. Bi-D adjustment
 6. Pixel Shift Adjustment
 7. PF adjustment
- Refer to "Chapter 5 Adjustment" for the adjustment procedures.
- After changing the Grounding Spring for a new one, always apply grease G-26 in the specified position. Refer to Chapter 6, Figure 6-7, "Lubrication Point 9".

4.2.17 Removing the PF Roller Support

1. Remove the PF Roller. (Refer to 4.2.15.)
2. Remove the Under Driven Roller.

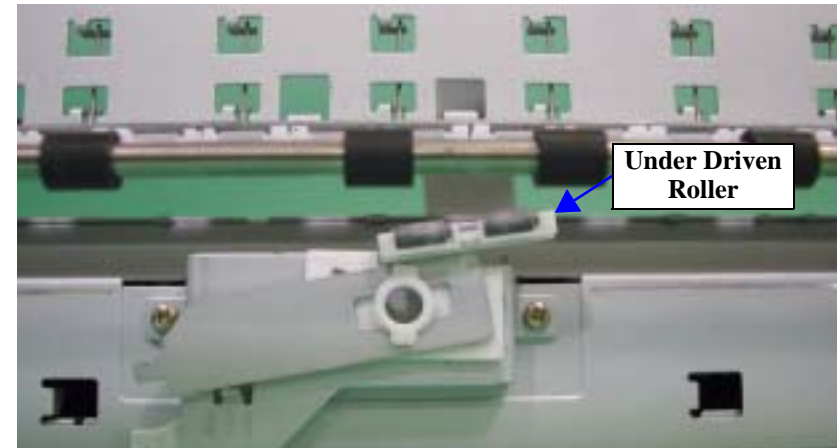


Figure 4-136. Removing the Under Driven Roller

3. Remove the two screws (6) C.B.S 3x6 (9±1kgf.cm) that secure the PF Roller Support, and slide the PF Roller Support to the top to remove it from the Upper Frame.

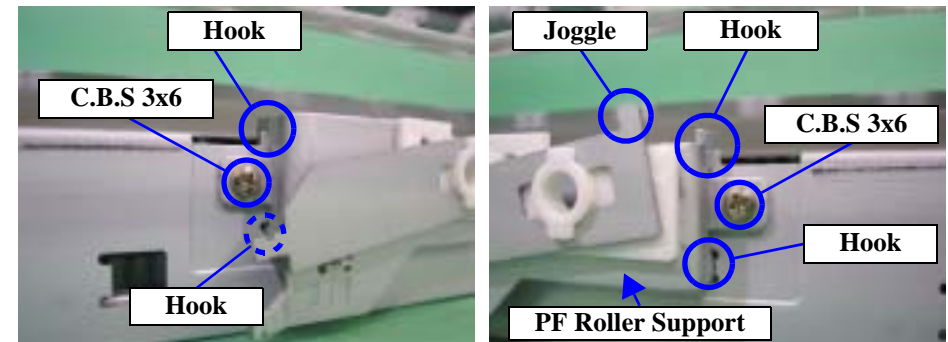


Figure 4-137. Removing the PF Roller Support



- When reinstalling the PF Roller Support, hitch the two upper hooks on the projections of the Under Frame, and insert the two lower hooks into the notches. Refer to Figure 4-137, "Removing the PF Roller Support".
- Place the Under Driven Roller on the joggle of the PF Roller Support in advance. Refer to Figure 4-137, "Removing the PF Roller Support".

4.2.18 Disassembling the Cutter Unit

4.2.18.1 Removing the Cutter Sensor

1. Remove the two screws 15) C.B.S 3×8 (9±1kgf.cm), two screws 6) C.B.S 3×6 (9±1kgf.cm) and two screws (T.B.D) that secure the Cutter Housing.
2. Release the three hooks located on the Cutter Unit bottom.

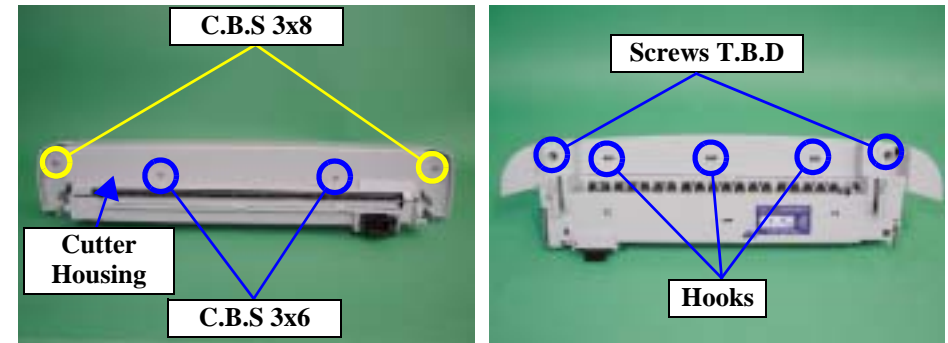


Figure 4-138. Screws That Secure the Cutter Housing

3. Pull and release the Joggle Supports, which secure the left and right of the Cutter Housing, to the front as seen from the Cutter Housing rear, and remove the Cutter Housing.

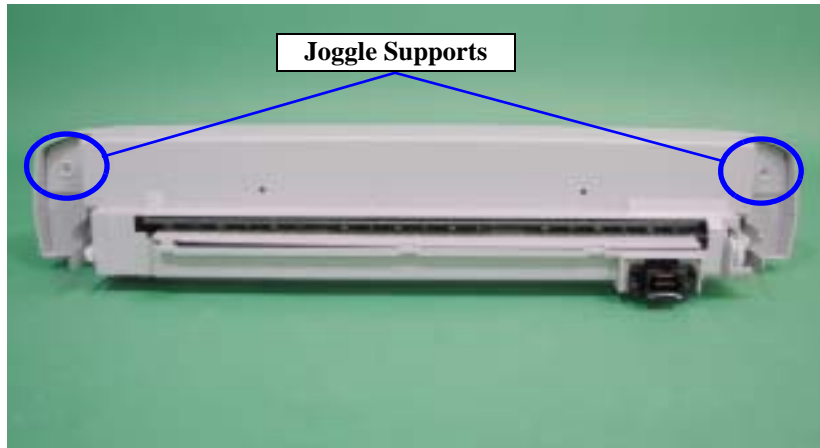


Figure 4-139. Joggle Supports That Secure the Cutter Housing



When reinstalling the Cutter Housing, match the two inner screws with the screw holes of the Harness Clamp as viewed from the Cutter Housing rear. (This also applies to the left side.) Refer to Figure 4-140, "Reinstalling the Cutter Housing".

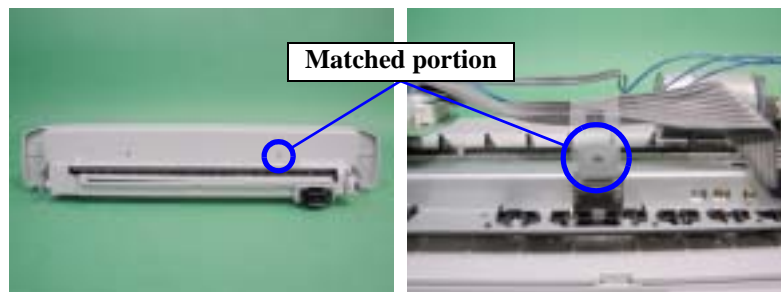


Figure 4-140. Reinstalling the Cutter Housing

4. Disconnect the Connector Cables (CN3, CN4) from the left and right Cutter Sensors.
5. Remove one (a total of two) screw 6) C.B.S 3x6 (9±1kgf.cm) that secures each of the left and right Cutter Sensors, and remove the Cutter Sensors.

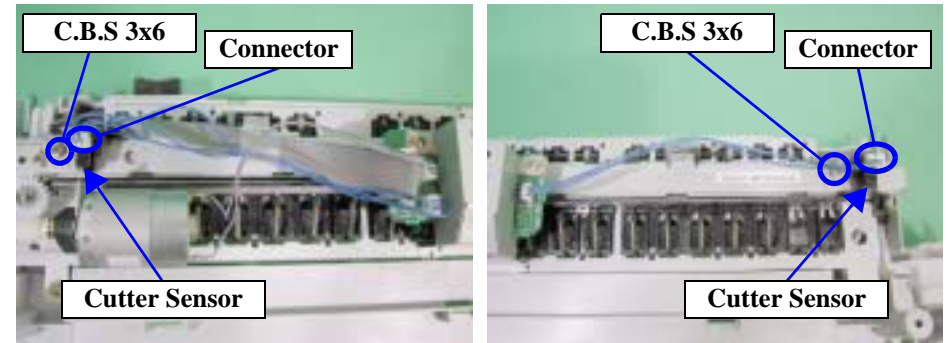


Figure 4-141. Screws That Secure the Cutter Sensors



Before reinstalling each of the Cutter Sensors, match it to the two (a total of four) joggles. Refer to Figure 4-142, "Reinstalling the Cutter Sensors".



Figure 4-142. Reinstalling the Cutter Sensors

4.2.18.2 Removing the Cutter Motor

1. Remove the Cutter Housing. (Refer to Steps 1 and 2 in 4.2.18.1.)
2. Disconnect the Connector Cable (CN2) from the Driver Board and release it from the Harness Clamp.

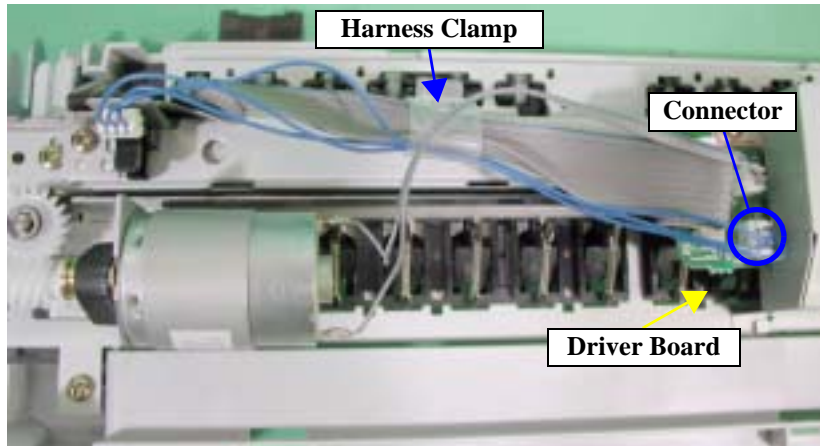


Figure 4-143. Disconnecting the Connector

3. Remove the two screws 16) C.P 2.5×3 (4±0.5kgf.cm) that secure the Cutter Motor, and while pulling and stretching the Timing Belt, remove the Pinion Gear of the Cutter Motor and remove the Cutter Motor from the Cutter Unit.

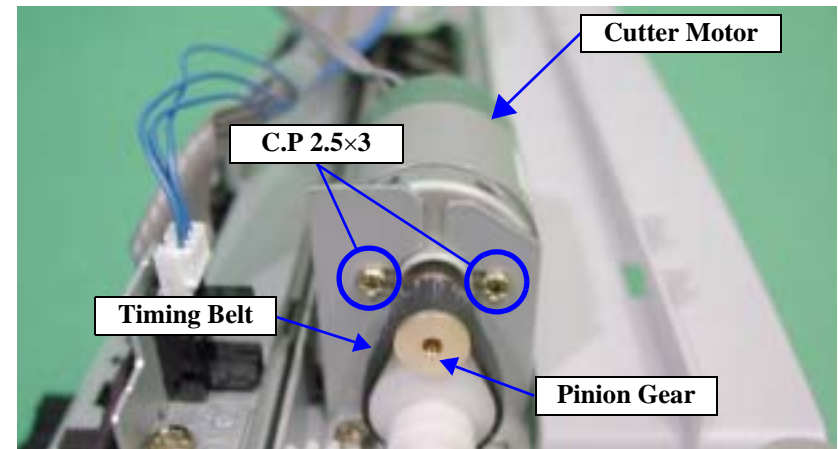


Figure 4-144. Screws That Secure the Cutter Motor

4.2.18.3 Removing the Driver Board

1. Remove the Cutter Housing. (Refer to Steps 1 and 2 in 4.2.18.1.)
2. Disconnect all Connector Cables from the Driver Board.

CHECK
POINT



- CN2 has a connector cable lock mechanism. Therefore, before disconnecting the Connector Cable, make sure that the lock mechanism has been cleared. When reconnecting the cable, insert the pins correctly into the corresponding cutouts of CN2. Refer to Figure 4-145, "Connector Cable Lock Mechanism".
- Mount the pin side, where a blue line is drawn on the Connector Cable, to the 1 pin side. Refer to Figure 4-145, "Connector Cable Lock Mechanism".

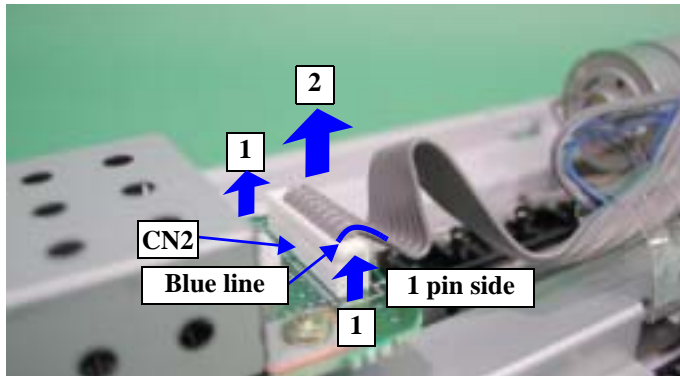


Figure 4-145. Connector Cable Lock Mechanism

3. Remove the two screws 6) C.B.S 3×6 (9±1kgf.cm) that secure the Board Plate and Driver Board.
4. Slide the Board Plate and Driver Board together to the left as viewed from the Cutter Unit front to release the two hooks, and after removing the Board Plate and Driver Board from the Cutter Unit, remove the Driver Board from the Board Plate.

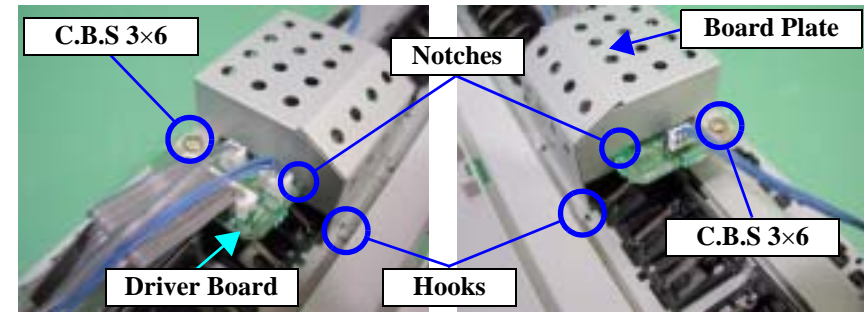


Figure 4-146. Removing the Driver Board



Insert the Driver Board into the notches of the Board Plate. Refer to Figure 4-146, "Removing the Driver Board".

4.2.19 Fitting the Protective Materials

This section describes how to fit the protective materials that are needed when returning the printer to the user.

1. Fit a protective material between the I/C Cover and Carriage Unit, and apply a blue tape from the Carriage Unit to the I/C Cover and to the right side (as seen from the printer front) of the Upper Housing to fix the Carriage Unit.

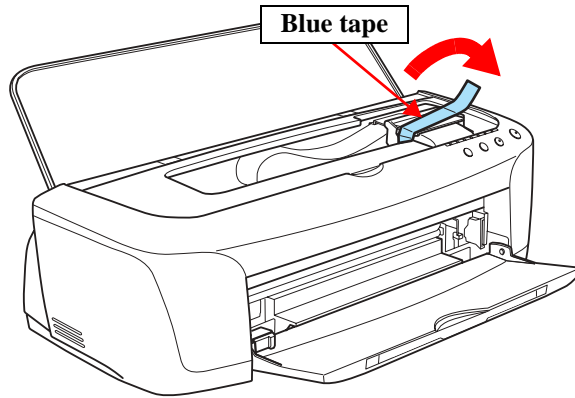


Figure 4-147. Fixing the Carriage Unit

2. Insert protective materials into the first and third stages of the Stacker and also insert a protective material into between the Stacker and Middle Housing.

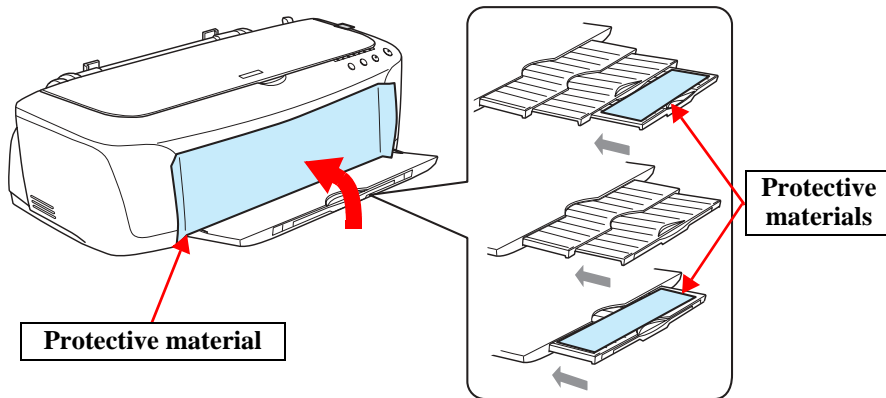


Figure 4-148. Fixing the Stacker

3. Apply blue tapes to two areas of the Upper Housing and Stacker to fix them.

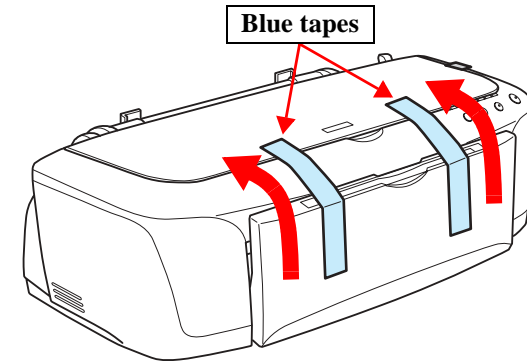


Figure 4-149. Fixing the Upper Housing and Stacker

4. Apply blue tapes to the left and right of the Rear Housing and Middle Housing to fix them.

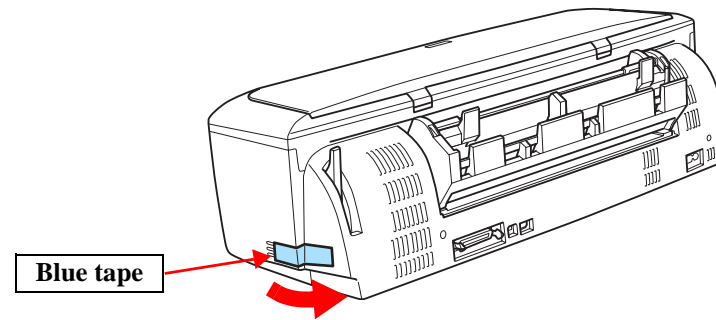


Figure 4-150. Fixing the Rear Housing and Middle Housing

CHAPTER

5

ADJUSTMENT

5.1 Adjustment Items and Overview

This chapter describes adjustments to be made after the disassembly/reassembly of this product.

5.1.1 Servicing Adjustment Item List

The adjustment items of this product are as follows. For details of the adjustment items, refer to the detailed procedures and sketches of the adjustment items.

Table 5-1. Servicing Adjustment Items

	Function Item	Purpose	Method Outline	Tool	Used Media
Main adjustment items	Destination data input	At the time of Main board replacement, this adjustment is made to write the board common information on a destination basis.	Select and execute this function in the exclusive servicing program to save the following data into the EEPROM. Market ID, CSIC printer ID, D4 setting (USB, parallel), CSIC ink name, printout position adjustment fixed value Supplement: Write of Ink Flags 1, 2 is not planned. (Since the initial filling flags are not set in general repair.)	Exclusive servicing program	Non-target
	Head ID input	At the time of head replacement, this adjustment is made to correct head manufacturing variations and eliminate the individual differences of print quality.	Enter the ID of the head QR code label applied to the Printhead into the exclusive servicing program to save it to the EEPROM on the Main board. (Supplement: Read the QR code label from left to right on the top row and from top to bottom in due order.)	Exclusive servicing program	Non-target
	CR variation correction	When the Main board, CR motor or PSB/PSE board is changed individually, this adjustment is made to write the maximum correction value to prevent the occurrence of damage to the motor at the time of CR motor heat generation. However, when the CR shaft is changed together with the above part, this adjustment is made to measure the manufacturing variations of the CR motor and PSB/PSE board, utilize the motor capability to the maximum for motor heat generation control, and prevent the motor from being damaged by CR motor heat generation.	Select/execute this function in the exclusive servicing program. When you turn on the check boxes of the corresponding parts changed during repair, the program automatically determines whether to enter the maximum value of CR variation correction or to measure CR variations, and performs either operation. The correction value is saved to the specific EEPROM address on the Main board.	Exclusive servicing program	Non-target
	PG adjustment	This adjustment is made to install the Front and Rear CR guide shafts in parallel to the print surface and to secure the predetermined clearance from the print surface in the PG 0 position.	Place the exclusive adjustment gauges (one set of left and right gauges) in the specified positions on the Paper guide, connect the Tester, adjustment gauges and Head grounding plate or Mechanical frame with Alligator clip cables, and check contact of the Head and adjustment gauges by Tester continuity. To make adjustment, vary the Adjust parallelism bush fixing positions of the printer CR main shaft/sub shaft.	<ul style="list-style-type: none"> • Exclusive servicing program • Exclusive PG adjustment gauges • Printer parallelism adjustment lever 	Non-target

Table 5-1. Servicing Adjustment Items

Function Item		Purpose	Method Outline	Tool	Used Media
Main adjustment items	Head angular adjustment	This adjustment is made to correct the error in the Head mounting position (angle of the Head to the print surface) to keep the nozzle intervals uniform in the main scanning direction.	Select this function in the exclusive servicing program and print the adjustment pattern. Check the displacement amount of the pattern and move the Adjust lever on the right side face of the CR unit as required. Print the exclusive pattern again and adjust the displacement amount.	<ul style="list-style-type: none"> Exclusive servicing program Adjust lever built in the CR unit 	Photo Quality Ink Jet Paper 2 (A4)
	PF adjustment	This adjustment is made to correct the variations of paper loading accuracy in the band printing mode to improve print quality.	Select this function in the exclusive servicing program and print the adjustment patterns (9 patterns). Select and enter the pattern number that has the smallest gap and overlap. The correction value is saved to the specific EEPROM address on the Main board.	Exclusive servicing program	Plain Paper (A4)
	PW sensor adjustment	This adjustment is made to correct the mounting position of the PW sensor on a software basis to minimize the paper detection error caused by the variations of the mounting position.	Select this function in the exclusive servicing program and print the adjustment patterns. Select the pattern number 5mm away from each edge, and enter that number in the program. The correction value is saved to the specific EEPROM address on the Main board.	Exclusive servicing program	Plain Paper (A4)
	Bi-D adjustment	This adjustment is made to correct the print timing in the go and return paths in bi-directional printing.	Select this function in the exclusive servicing program and print the adjustment patterns to check the displacement amounts of the patterns. Select/enter the pattern number that has the smallest displacement amount in the program. Print the exclusive patterns again and adjust the displacement amount. The correction value is saved into the EEPROM.	Exclusive servicing program	Photo Quality Ink Jet Paper 2 (A4)
	Pixel shift adjustment	This adjustment is made to correct the variations of the ink injection speeds of the Nozzle lines in VSD 4 printing to reduce the displacements of the image in high resolution.	In the VSD 4 mode, select the pattern that has the smallest displacement amount from the printed rule patterns per line, and enter it into the program. The correction value is saved into the EEPROM.	Exclusive servicing program	Photo Quality Ink Jet Paper 2 (A4)
	CR timing belt tension adjustment	This adjustment is made to prevent a tooth skip between the CR motor and Timing belt, which occurs with the increased size of the CR, in order to optimize the Timing belt tension.	Insert a thickness gauge (0.3mm or less) between the Pulley frame and Fixing plate and secure the Fixing plate.	Thickness gauge 0.3mm	Target

Table 5-1. Servicing Adjustment Items

Function Item		Purpose	Method Outline	Tool	Used Media
Main adjustment items	Cutting position adjustment	This adjustment is made to correct the cutting position accuracy of the roll paper when the Auto cutter is fitted.	Print the print patterns from the adjustment program and cut the print patterns with the Auto cutter. Select the pattern number where the cutting position in the pattern is the nearest to the color boundary position of the pattern, and enter it from the program. The correction value is saved into the EEPROM.	Exclusive servicing program	Roll Paper
	USB ID input	This adjustment is made to allow the PC to recognize the connected printers individually when multiple printers of the same model are connected and used with the PC via a USB hub.	Select this function in the exclusive servicing program and enter the serial numbers of the printers. The correction value is saved to the specific EEPROM address on the Main board.	Exclusive servicing program	Non-target
	IEEE1394 ID input	This adjustment is made to provide the product with the unique ID for identification of this printer in the IEEE1394 connection environment.	Since the unique codes of 4.5 million units have been assigned to the EPSON Stylus PHOTO 2100/2200 as the IEEE1394 ID, unique codes cannot be generated randomly. The correction value is saved to the specific EEPROM address on the Main board.	Exclusive servicing program	Non-target
	Left/right margin	This adjustment is made to correct the printout position in the CR main scanning direction.	Select/execute this function in the exclusive servicing program. Enter the correction value in the program using the rule position of the print pattern as a reference. The correction value is saved to the specific EEPROM address on the Main board.	Exclusive servicing program	Plain paper

Table 5-2. Maintenance Functions

Function Item		Purpose	Adjustment Outline	Tool	Used Media
Maintenance items	Ink charge sequence execution	This function is used to drain the S46 Shipping Liquid in the ASP head flow path and simultaneously fill ink in the head flow path to make all nozzles printable and stabilize the ink in the Head.	Select this function in the exclusive servicing program, and execute the ink sucking operation equivalent to the initial charge.	Exclusive servicing program	Non-target
	Powerful CL execution	This function is used to execute CL efficiently when ink is not delivered from the Head properly, e.g. dot missing or skewed injection. This function is used together with the nozzle check pattern to confirm the CL effects.	Select this function in the exclusive servicing program, and execute CL 4.	Exclusive servicing program	Non-target
	Waste ink counter read/reset	This function is used after repair to read the Waste ink counter, and if the value is close to the predetermined near-end value or end value, to recommend Pad replacement to the user in order to prevent the repaired printer from being returned again for repair in a short time. The reset function is used to reset the Waste ink counter from the exclusive program after Waste ink pad replacement.	Select this function in the exclusive servicing program, read/display the current data from the specific EEPROM address on the Main board, and check whether the current counter value is close to the upper limit or not. For the reset function, select this function in the exclusive servicing program after Waste ink pad replacement, and reset the corresponding data at the specific address in the EEPROM on the Main board.	Exclusive servicing program	Non-target
	Main board data read/write function	This function is used to read the above necessary information from the EEPROM of the faulty Main board using the D4 function to reduce the auxiliary adjustment items at the time of Board replacement.	Select this function in the exclusive servicing program, and read the data from the faulty board. After that, change the Main board and then write the read data to a new board.	Exclusive servicing program	Non-target

Table 5-3. Check Pattern Printing

Function Item		Purpose	Adjustment Outline	Tool	Used Media
Check pattern items	A3+, Photo Quality Ink Jet Paper 2 printing	This pattern is used to check whether all adjustment results are normal.	Select this function in the exclusive servicing program, print the print patterns, and check the adjustment result in each pattern.	Exclusive servicing program	A3+/Photo Quality Ink Jet Paper 2
	Standard sample printing	This pattern is used to make a simple print check at the EPSON service company.	This pattern is used to make a simple print check at the EPSON service company.	Exclusive servicing program	Non-target
	Nozzle check pattern printing	This pattern is used to check simply whether all nozzles deliver ink or not.	This pattern is used to make a simple print check at the EPSON service company.	Exclusive servicing program	Plain paper

Table 5-4. Check Pattern Printing

Function Item	Purpose	Adjustment Outline	Tool	Used Media
EEPROM DUMP function	This function is used to analyze a faulty product.	Set and read the corresponding address of the EEPROM. Write the specific value to the corresponding address as required.	Exclusive servicing program	Non-target
Paper passing test	This function is used to make a reproduction test or operation check.	Up to 100 pieces of paper can be set for continuous passage.	Exclusive servicing program	Non-target
Printer information read	This function is used to analyze a faulty product. This function reads and displays the fundamental information that indicates the operating status of the printer.	<ul style="list-style-type: none"> • Cumulative print page read • Cumulative print path read • Each CL execution count read • Initial charge execution count read • Cutter cut count read 	Exclusive servicing program	Non-target
EEPROM reset	This function makes a reset that is equivalent to the EEPROM reset function from the panel.	The following EEPROM address values are reset. 26<h> – 27<h> Last Cleaning Time 28<h> – 29<h> Power Off Time 44<h> Interface Selection	Exclusive servicing program	Non-target

5.1.2 Priority of Adjustment Items

The items on the upper level should be adjusted earlier. The items in the horizontal direction have the same priority.

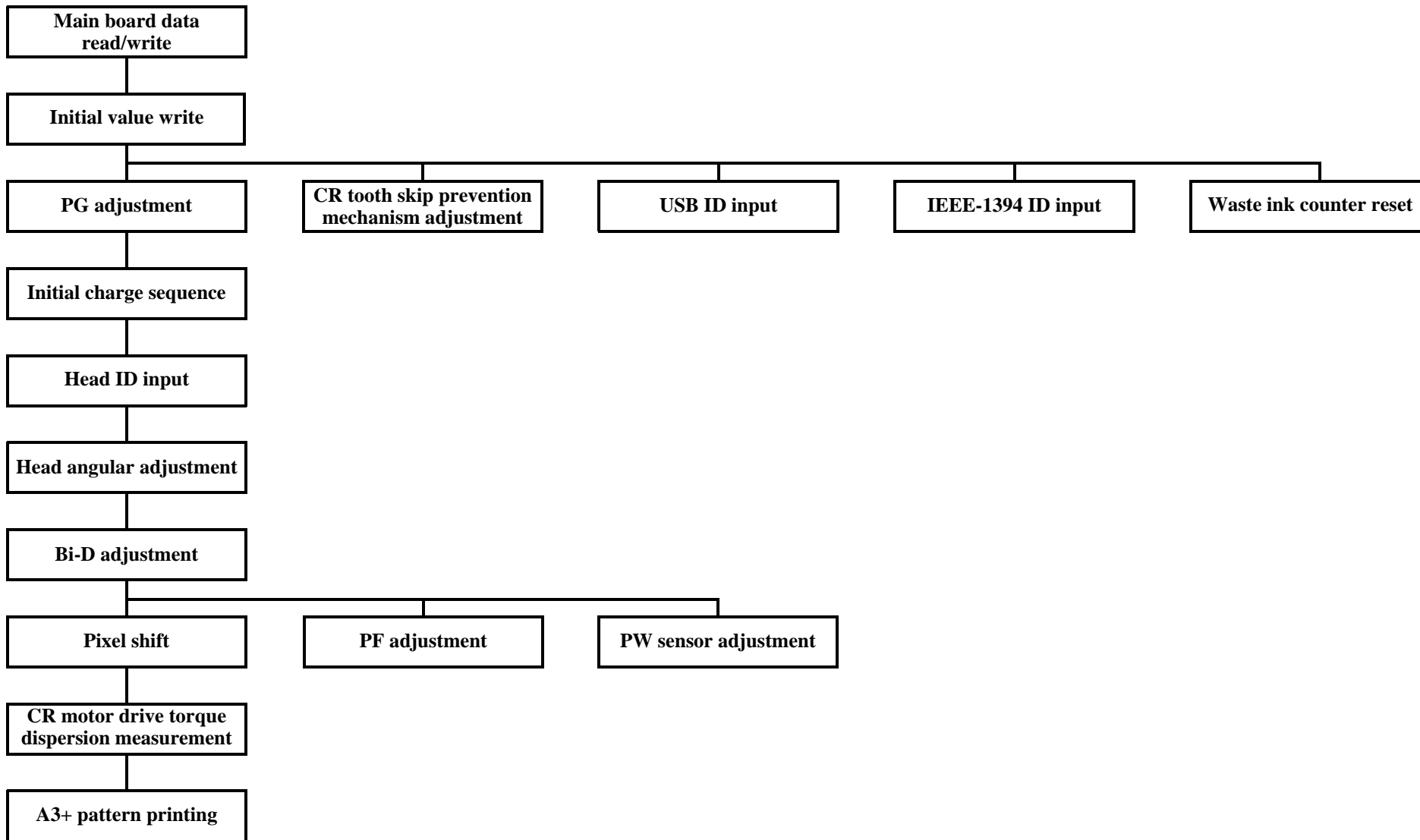


Figure 5-1. Priority of Adjustment Items

5.1.3 Replacement Part-Based Adjustment Priorities

The following table indicates the adjustment items and priorities on a replacement part basis.

Table 5-5. Replacement Part-Based Adjustment Item and Priority List 1

Adjustment Item	Head Replacement	Head Removal	Main Board Replacement ^(*a)	Main Board Replacement ^(*b)	PSB/PSE Board Replacement	Waste Ink Pad Replacement	PW Sensor Replacement/Removal	CSIC Board Replacement/Removal
Main board data read/write	—	—	1	1	—	—	—	—
Initial value write	—	—	—	2	—	—	—	—
PG adjustment	1 (Recommended)	1 (Recommended)	—	—	—	—	1	1
CR tooth skip prevention mechanism adjustment	—	—	—	—	—	—	2	2
USB ID input	—	—	—	3	—	—	—	—
IEEE-1394 ID input	—	—	—	3	—	—	—	—
Waste ink counter reset	—	—	—	—	—	1	—	—
Initial charge sequence	2	—	—	—	—	—	—	—
Powerful CL	— (Executed as required)	2	—	—	—	—	3	3
Head ID input	3	—	—	4	—	—	—	—
Head angular adjustment	4	3	—	—	—	—	4	4
Bi-D adjustment	5	4	—	5	—	—	5	5
Pixel shift adjustment	6	5	—	6	—	—	—	—
PF adjustment	—	—	—	7	—	—	—	—
PW sensor adjustment	—	—	—	8	—	—	6	—
CR motor drive torque dispersion measurement	—	—	—	9	1	—	—	—
A3+ pattern printing	7	6	2	10	2	2	7	6
PG adjustment jigs	1	1	—	—	—	—	1	1
Loop scale application jig	—	—	—	—	—	—	—	—
CR tooth skip prevention mechanism adjustment gauge	—	—	—	—	—	—	2	2

Table 5-6. Replacement Part-Based Adjustment Item and Priority List 2

Adjustment Item	CR Motor Replacement	PF Motor Replacement	ASF/Pump Motor Replacement	PF Encoder Sensor Replacement	CR Unit Removal	PF Roller Replacement	Paper Eject Roller A Removal	ASP Mechanism Unit	ASF Unit
Main board data read/write	—	—	—	—	—	—	—	—	—
Initial value write	—	—	—	—	—	—	—	—	—
PG adjustment	—	—	—	—	1	1	1	1(*c)	—
CR tooth skip prevention mechanism adjustment	1	—	—	—	2	2	2	2(*c)	—
USB ID input	—	—	—	—	—	—	—	—	—
IEEE-1394 ID input	—	—	—	—	—	—	—	(*d) —	—
Waste ink counter reset	—	—	—	—	—	—	—	—	—
Initial charge sequence	—	—	—	—	—	—	—	—	—
Powerful CL	—	—	—	—	3	3	3	3	—
Head ID input	—	—	—	—	—	—	—	—	—
Head angular adjustment	—	—	—	—	4	4	4	4	—
Bi-D adjustment	—	—	—	—	5	5	5	5	—
Pixel shift adjustment	—	—	—	—	—	—	—	6	—
PF adjustment	—	1	—	—	—	6	6	7	—
PW sensor adjustment	—	—	—	—	7	7	7	8	1
CR motor drive torque dispersion measurement	2	—	—	—	—	—	—	9	—
A3+ pattern printing	3	2	1	1	8	8	8	10	2
PG adjustment jigs	—	—	—	—	1	1	1	1	—
Loop scale application jig	—	—	—	—	—	When applying Loop scale	When mounting Spur gear A	—	—
CR tooth skip prevention mechanism adjustment gauge	1	—	—	—	2	2	2	2	—

*a: When data can be read from the old board

*b: When data cannot be read from the old board. Also replace the Waste ink pads.

*c: Since the ASP mechanism is submitted to print inspection and cleaning in the processes and is then packed after removal of the Board unit, Head, ASF, Waste ink pads, Housing and like, the adjustment items marked (*c) have already been executed but are executed as extra precautions.

*d: Basically, peel the IEEE-1394 label applied to the old ASP mechanism and apply it to the specified position of the new mechanism.

5.1.4 Required Jigs, Tools and Like

The following table indicates the adjustment jigs, tools and like necessary for the adjustments of this product.

Table 5-7. Adjustment Tools

No.	Name
1	Exclusive servicing program
2	PG adjustment gauge (Code: 1113311)
4	Loop scale application jig
5	CR tooth skip prevention mechanism adjusting thickness gauge (0.3mm)
6	Oil, type O-12 (Code: 1038991)
7	Grease, type G45 (Code: 1033657) G56 (Code: 1059150)
8	Shipping Liquid S46

5.2 Adjustments

The procedures of the adjustment items will be explained here. This section describes only the following adjustment items that require the adjust lever moving, printing pattern checking and other operations in the adjustment program operation outline and adjustments.

- Servicing program usage outline
- Head ID input
- CR motor drive torque dispersion measurement
- PG adjustment
- Head angular adjustment
- PF adjustment
- PW sensor adjustment
- Bi-d adjustment
- Pixel shift adjustment
- Cut position adjustment
- USB ID input
- IEEE 1394
- Left/right margin

CAUTION



When the Main board unit is replaced with new one and run the Adjustment program connecting the PC and the Printer, the Adjustment program indicates the ERROR (The printer indicates the Ink out error on the LED even if the correct I/C is installed) and can not proceed to the Main Adjustment menu in case you use the USB cable.

In this case, connect the printer and the PC with the Parallel I/F and run the Adjustment program again. The adjustment program can proceed to the Main Adjustment menu even if the same Error is indicated. After that, choose the Market setting item in the Adjustment Main menu and carry out the setting to set the market setting into the EEPROM.

5.2.1 Servicing Program Usage Outline

This program is used to perform each adjustment requested after specific parts have been repaired or replaced.

- Compatible OS : Windows 95/98/Me
- Compatible interface port : USB 1.2, Parallel interface (IEEE-1284.4)

The program consists of the following main functions.

- Adjustment
Select and execute any of the following adjustment items.

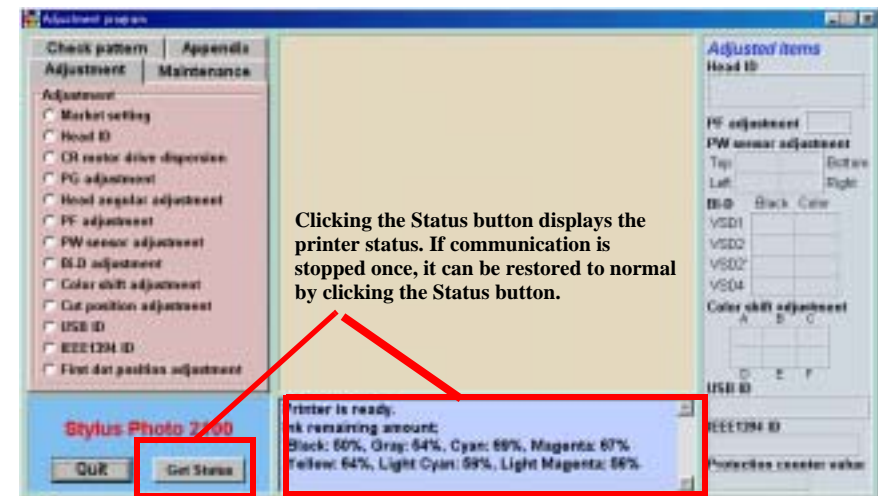


Figure 5-2. Adjustment Top Menu

CHECK POINT



In this program, clicking the Adjustment procedure explanation or Adjustment method button on any of the adjustment item screens shows the adjustment procedure and outline.

- Maintenance
Used to reset the Waste ink pad counter, ink charge, perform cleaning, and copy the EEPROM data at the time of board replacement.



Figure 5-3. Maintenance Top Menu

- Additional functions
Used to perform EEPROM data read/write, reset and paper passage test function (max. 100 pieces of paper).

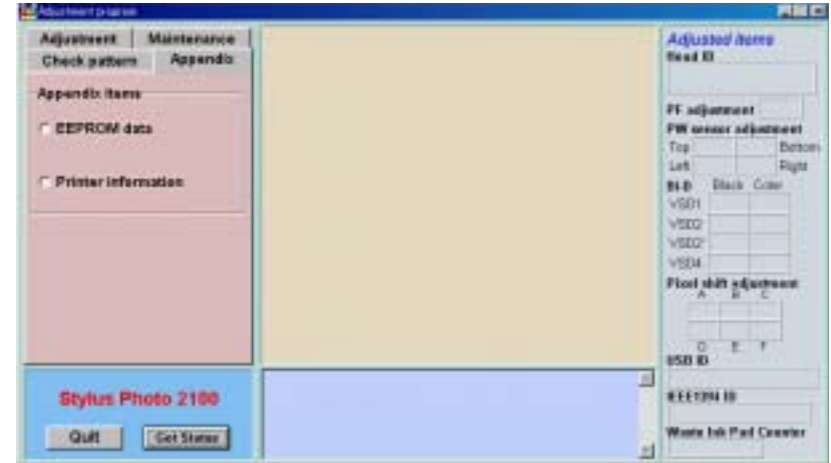


Figure 5-5. Additional Function Top Menu

- Check pattern printing
Used to print the A3+ final check pattern, EPSON service company standard sample, and nozzle check pattern.

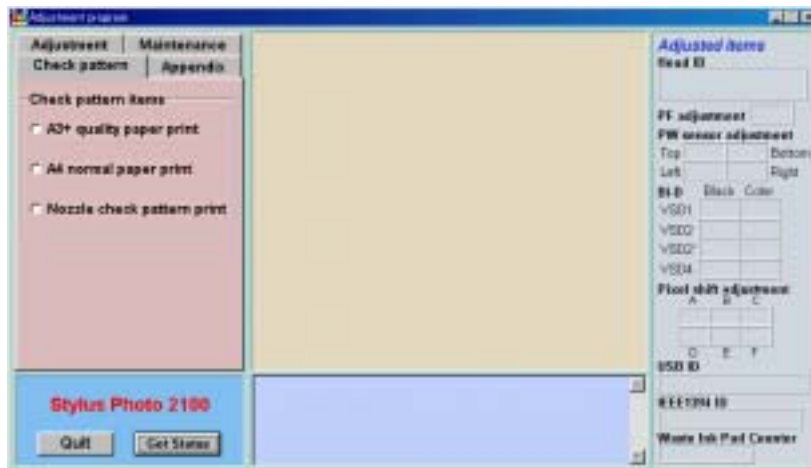


Figure 5-4. Check Pattern Top Menu

5.2.2 Head ID Input Function

This function is designed to correct ink discharge amount variations due to individual manufacturing differences between Printheads when the Printhead is replaced.

1. Choose the Head ID of the adjustment program.
2. Enter the 25-digit code of the Head ID label applied to the Printhead. Enter the Head ID from left to right on the top row and from top to bottom in due order.

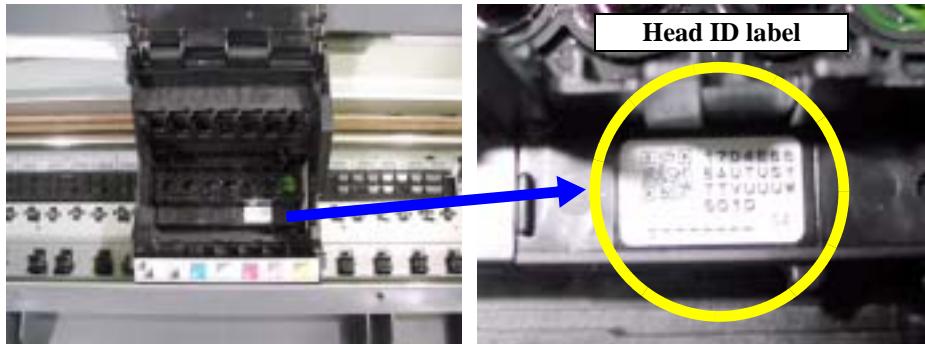


Figure 5-6. Head ID Label

5.2.3 CR motor drive torque dispersion measurement

When the Main board, CR motor or PSB/PSE board is changed individually, the maximum variation correction value is written to prevent the motor from being damaged at the time of CR motor heat generation.



When the maximum CR variation value is entered, CR motor heat generation control may start earlier than normal during continuous printing depending on the product.

When the CR shaft is changed together with the Main board, CR motor or PS board, the manufacturing variations of the CR motor and PSB/PSE board are measured, the motor capability is utilized to the maximum for motor heat generation control, and the variation value of the product is measured and saved into the EEPROM to prevent the motor from being damaged by CR motor heat generation.

1. Choose CR variation correction in the adjustment program.

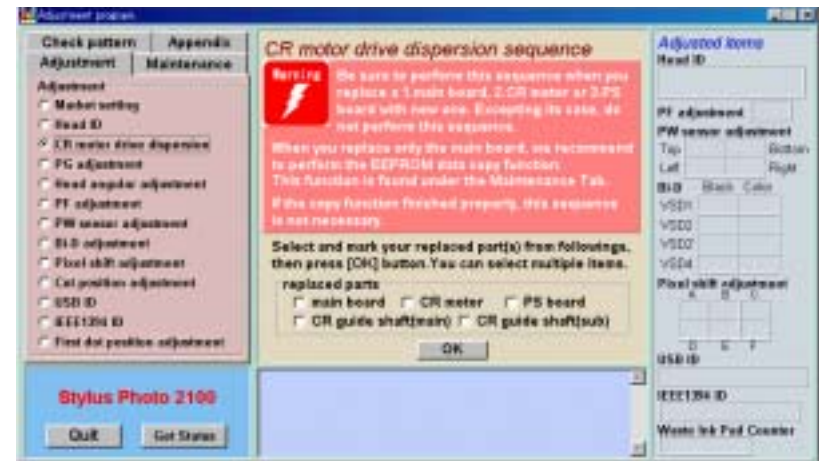


Figure 5-7. CR motor drive torque dispersion measurement Screen

2. Following the screen prompts, turn on the necessary Replacement part check box and click the OK button. According to the replacement part, variation value write and variation measurement/write are performed automatically.

5.2.4 PG Adjustment

When any of the following parts has been removed or replaced, this adjustment must be performed to secure the specified clearance for the print surface and paper.

- Carriage unit
- Carriage guide shafts A, B
- Adjust parallelism bushes, sub adjust parallelism bushes
(Including the case where positions have been shifted)

NOTE: It is recommended to make this adjustment when the Head was removed/replaced.

In addition to the servicing program, the exclusive adjustment gauges are used in this adjustment. One set of the exclusive adjustment gauges consists of two gauges for left and right.

NOTE: There are two different types of adjustment gauges. One has one rail and the other has two rails on the side that is mounted on the Front paper guide. They have the same functions and quality.

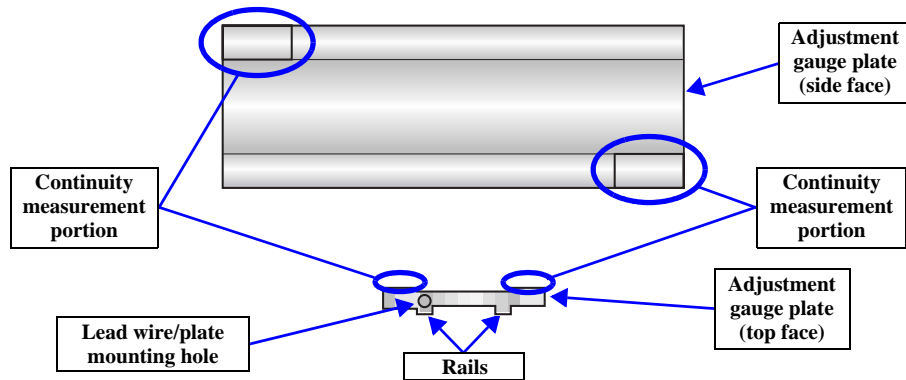


Figure 5-8. Adjustment Gauge Appearance

For the adjustment gauges, the arm parts and fixing screws are available as accessories for connection of the Alligator clips of the Tester. If the rigidity of the Alligator clip cables used with the Tester is high, it is recommended to use lead wires of low rigidity instead of the supplied arms.

In either case, note the orientation of mounting.

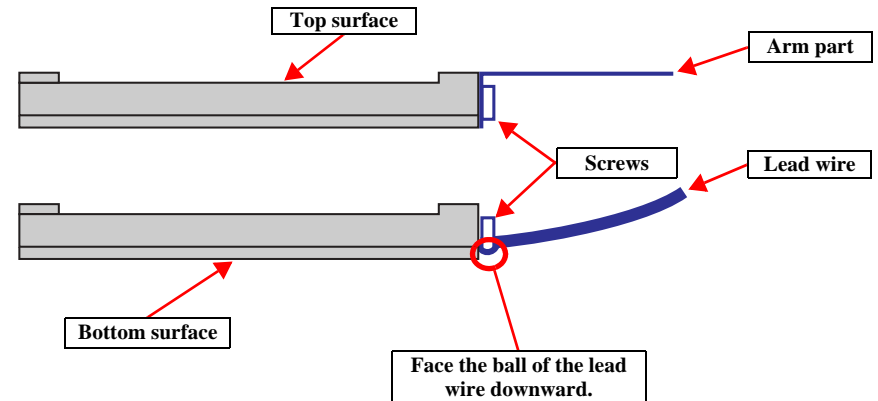


Figure 5-9. Orientation of Mounting the Lead Wire/Arm Part



- Do not touch the adjustment gauge plate surface with bare hands.
- If the adjustment gauge plate surface is stained by ink or like, wipe it with a soft cloth or like.
- In case the Platen Gap is not adjusted in the standard and it is narrow value, this printer has a tendency that the color of the printed image will have redness depend on the printed image. So, this adjustment must be done with precision

5.2.4.1 PG Adjustment Method

1. When replacing the Printhead, make sure that there is no Shipping Liquid sticking on the Head surface, and then install the Head on the Carriage unit.



When removing/reinstalling the Printhead, completely wipe the drops of ink off the metal frame section on the Head nozzle surface with the ASP cleaner blade, which was kept clean, or a clean, soft cloth (cloth that will not fluff), and then install the Printhead to the Carriage unit.



If the drops of ink and Shipping Liquid have stuck to the Head nozzle surface or Nozzle plate metal frame, fully be careful since the PG cannot be adjusted accurately due to continuity that occurs before contact of the Nozzle plate metal frame and gauge adjustment portions.

2. Remove the Printer mechanism together with the Board unit from the Lower housing, and place it on a level base.



- Before starting PG adjustment, load all Ink cartridges into the CR unit. If the Ink cartridges have not been loaded, the CR weight will be instable and the PG may not be adjusted properly.
- After removing the Printer mechanism, place a rag or ASP waste ink pad under the Waste ink tube to prevent the desk from being contaminated.
- Put the Printer mechanism on the flat stable work table. If you adjust the PG on the unstable table that the surface is not flat, the PG adjustment is affected by the table condition and the PG can not be adjusted correctly even if the adjustment lever over the adjustment range. So, after put the Printer mechanism on the table, check that the printer dose not move rumbly by shaking the mechanism on the table.

3. Loosen the screws of the Adjust parallel bushes and Sub adjust parallel bushes.
4. Place the Release lever in the envelope mark position to increase the PG.

5. Press the jig setting position movement button in the servicing adjustment program.



Figure 5-10. Adjustment Program

6. Screw the left and right PG gauge lead wires or arms to the Gauges, and matching the Adjustment gauges to their respective edges, set them in the specified positions (left end/right end of the rib on the Paper guide). At this time, make sure that the Adjustment gauges are installed securely and evenly.

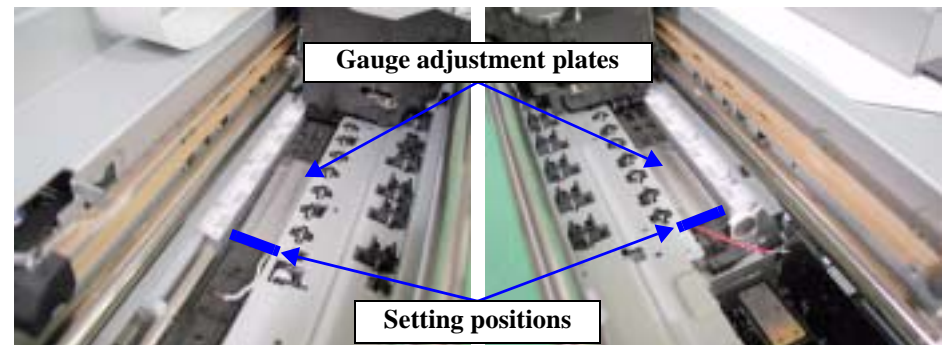


Figure 5-11. Adjustment Gauge Setting Positions

7. Press the right main shaft adjustment position movement button in the adjustment program to move the Carriage to the PG main shaft right adjustment position.

8. Set the Tester to the resistance value measurement mode, and insert the Alligator clip cables into both terminals of the Tester. Connect the lead wire of the Gauge and the Grounding plate on the Carriage side or the Top frame with the Alligator terminals of the Tester.

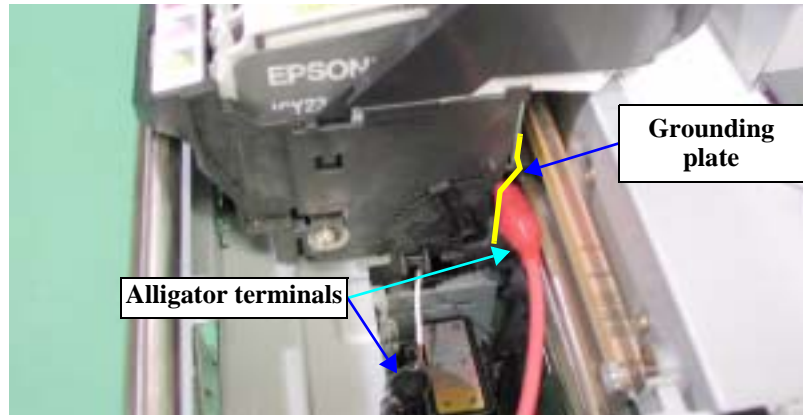


Figure 5-12. Connection of Lead Wire



If the rigidity of the Alligator terminal cables of the Tester is high, the Gauge adjustment plate will move. Therefore, it is recommended to use the cables whose rigidity is as low as possible.

9. Return the Release lever to the front position to minimize the PG.
10. Move the Adjust parallelism bush (right) until continuity is confirmed. Raise the Adjust parallelism bush (right) one step up from the position where continuity was confirmed. At this time, move the Adjust parallelism bush (right) to make sure that the position where continuity is confirmed is the same as the position where continuity is lost.



- The following figure shows the states of the Adjust parallelism bush (right) and PG.

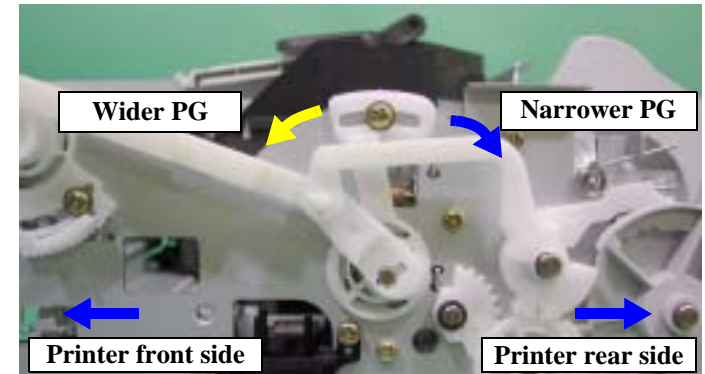


Figure 5-13. Parallelism Adjustment Lever Operating Method

As in Figure 5-13, moving the Adjust parallelism bush (left) or Sub adjust parallelism bush (right/left) to the printer front side increases the PG, and moving it to the printer rear side decreases the PG.

- If the continuity state of the Tester is instable, there is a strong likelihood that the drops of ink or Shipping Liquid have stuck to the Head surface. Therefore, remove and wipe the Head.
- By moving the Main Parallelism Adjustment lever with one notch, the CR unit moves 0.05mm upward or downward. By moving the Sub Parallelism Adjustment lever with one notch, the CR unit moves 0.08mm upward or downward.

11. After adjustment is over, place the Release lever in the envelop mark position again to increase the PG.
12. Repeat Steps 6 to 10 for PG main shaft left adjustment, PG sub shaft right adjustment, and PG sub shaft left adjustment in this order. At this time, press the carriage unit movement button in the adjustment program to move the Carriage unit.

CHECK
POINT

- There are five different carriage movement buttons in the adjustment program: PG jig setting position movement, PG right main shaft adjustment position, PG left main shaft adjustment position, PG right sub shaft adjustment position, PG left sub shaft adjustment position.
- If the Release lever is in the release position, pressing the button for movement to any adjustment position will cause an error. Therefore, always place the Lever in the PG + position (envelope mark position).
- If PG adjustment cannot be made within any Adjust parallelism bush adjustment notch range, change the setting positions of all Adjust parallelism bushes to the center position and make readjustment in all adjustment positions.

CHECK
POINT

Before printing the PG adjustment check pattern, you should have terminated the Bi-D adjustment and Head angular adjustment. If these adjustments have not been made, the displacements of Bi-D and Head angle are reflected on the PG adjustment pattern, and PG adjustment results cannot be checked completely.

13. After the PG main shaft (left and right) and PG sub shaft (left and right) have been adjusted, print the check pattern. This pattern is used to check for parallelism between the CR main shaft and sub shaft. If the gap and overlap between the blocks are within 0.18mm, terminate the adjustment. If the gap and overlap are more than 0.18mm, execute Steps 3 to 11 again.

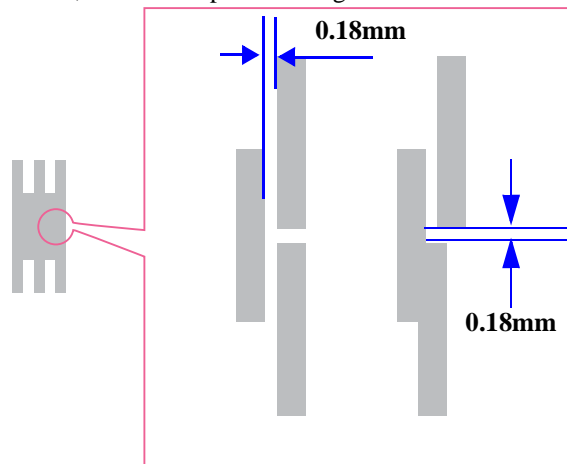


Figure 5-14. Check Pattern

5.2.5 Head Angular Adjustment

This adjustment is made to correct physically the assembling error of the Printhead relative to the CR unit. To make Head angular adjustment, adjust the angle of the Head relative to the CR main operation direction by moving the adjust lever installed on the right side face of the CR unit. By shifting the Y nozzle line with respect to the Head Bk nozzle line with this Adjust lever in the paper loading direction, make adjustment until the Head does not tilt.

Before starting this adjustment, remove the following part.

- Upper housing

1. Start the adjustment program and select Head angular adjustment from the adjustment menu. Click the Print button to print the head angular adjustment pattern.



- Use Photo quality ink jet paper for Head angular adjustment.

2. In the printed Head tilt adjustment pattern, make adjustment until each light magenta rule is aligned with the center of the black rules.

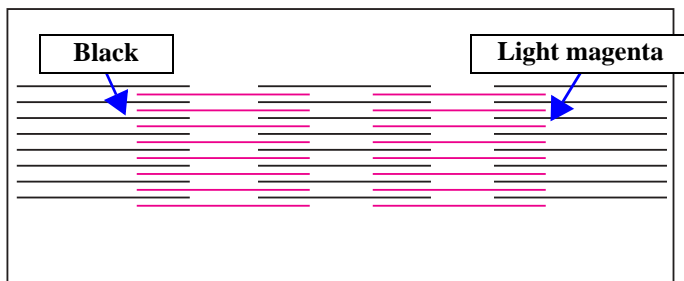


Figure 5-15. Head Angular Adjustment Pattern

The following figure shows the relationships between the Adjust lever and Head adjustment check pattern.

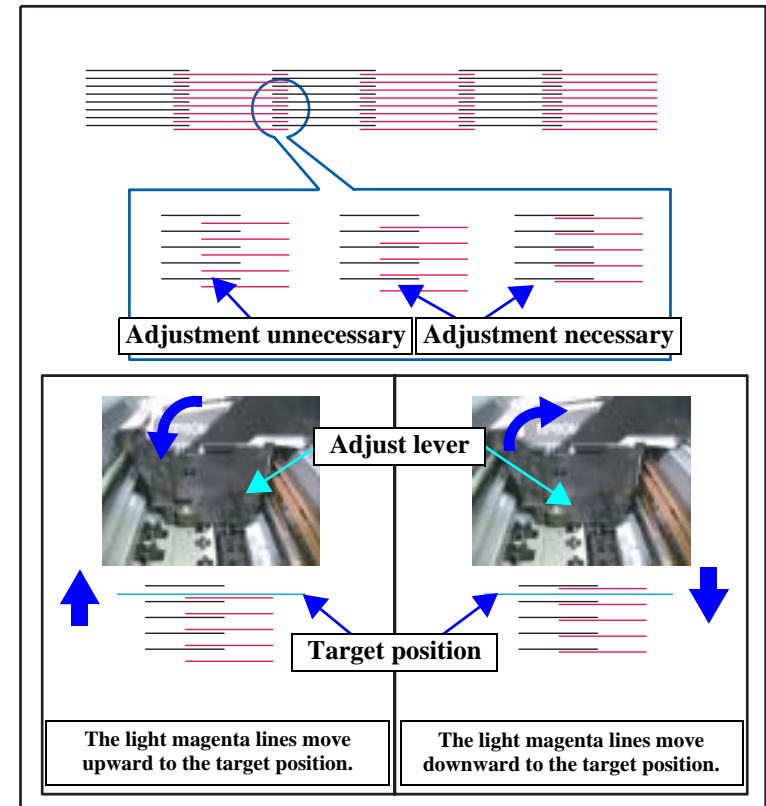


Figure 5-16. Adjust Lever and Head Angular Adjustment Check Pattern

- Before moving the Adjust lever, remove the Ink cartridges, loosen the two screws that secure the I/C spring and Head fastener, and remove the Torsion spring on the left of the CR.

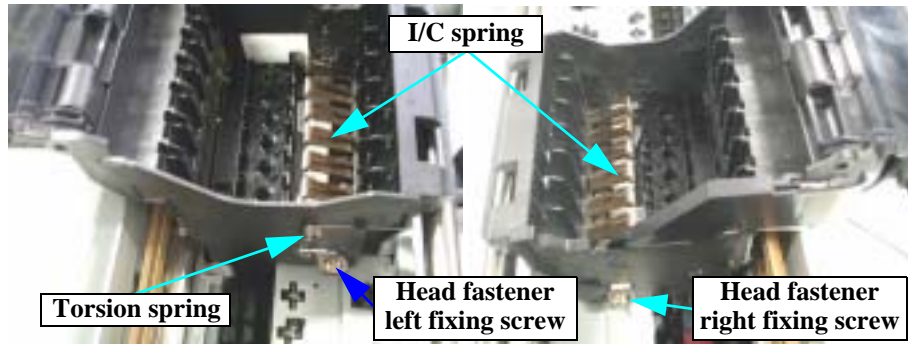


Figure 5-17. Head Fastener Fixing Screws and Torsion Spring

- Refer to Figure 5-16 and move the Adjust lever, and while pressing both ends of the Head fastener against the far side of the CR, tighten the fixing screws.



Figure 5-18. Head Fastener Fixing Method

- Fit the Ink cartridges, print the Head tilt adjustment pattern, and check the adjustment result.

- Execute Steps 1 to 5 until the black and light magenta rules are at uniform intervals.



When moving the Head angular adjust lever again after checking the adjustment result, always remove the Ink cartridges, loosen the Head fastener fixing screws, and then move the Adjust lever.

5.2.6 CR Tooth Skip Prevention Mechanism Adjustment

Since this adjustment prevents a tooth skip between the CR motor and CR timing belt and optimizes the timing belt tension, this adjustment must be made when the following part is removed.

- CR timing belt

The following explains the method of making this adjustment.

1. After making sure that the CR timing belt is not twisted, install the CR timing belt between the Driven pulley holder and CR motor.
2. Insert a thickness gauge (0.3mm) between the Driven pulley holder and Belt pulley plate to secure a gap.

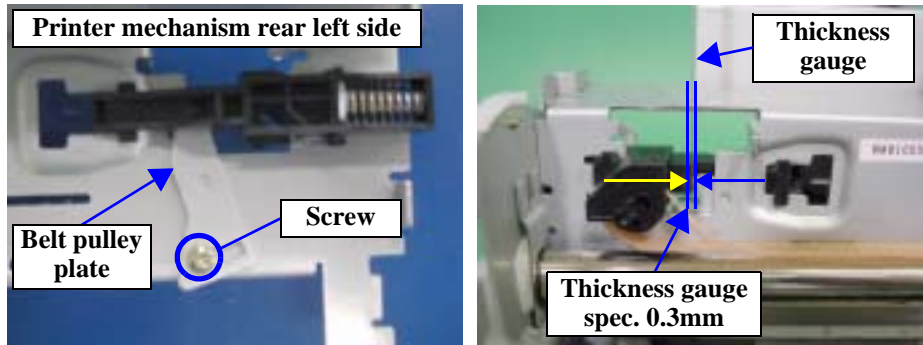


Figure 5-19. Thickness Gauge Setting

3. With the gap secured, fix the screw in the Belt pulley plate.

5.2.7 PF Adjustment

This adjustment is made to adjust the paper loading amount in the 360dpi print mode where paper is loaded in the nozzle line width. The following shows the PF adjustment check patterns.

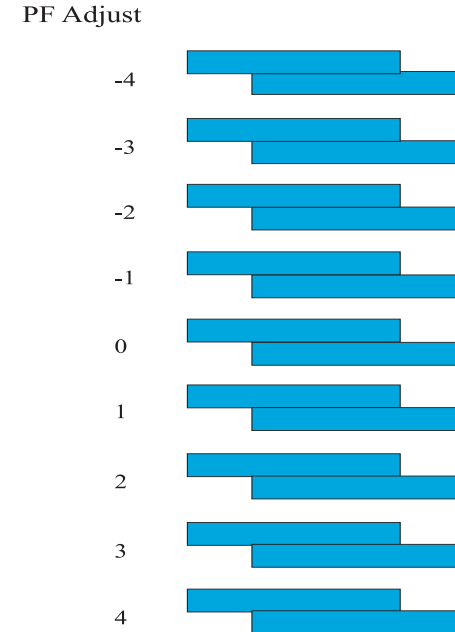


Figure 5-20. PF Adjustment Check Patterns

1. Select PF adjustment in the adjustment program.
2. Print the PF adjustment check patterns, choose the pattern that has the smallest displacements, and enter it in the adjustment program.
3. Print the check patterns again, and check the adjustment result.

5.2.8 PW Sensor Adjustment

This adjustment is made to minimize the paper detection error that is produced by replacing or removing the PW sensor.

The following shows the PW sensor adjustment check patterns.

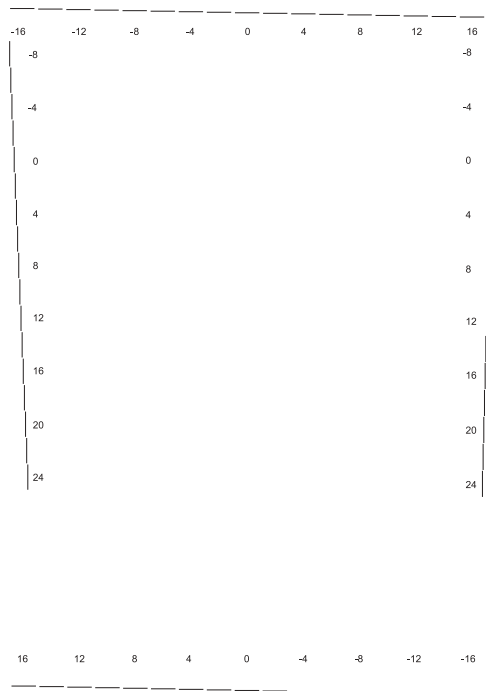


Figure 5-21. PW Sensor Adjustment Check Patterns

1. Select PW sensor adjustment in the adjustment program.
2. Print the PW sensor adjustment check patterns, choose the pattern number 5mm away from each edge, and enter it in the adjustment program.



During the printing of the PW adjustment pattern, do not open the Printer cover. The PW sensor may be affected the light and the sensor can not detect the edge of the paper.

If the adjustment pattern is not printed on the paper (especially right side pattern on the pined paper) even if the printer cover is closed during the printing, check whether any foreign object or small paper scrip is on the Paper guide front.

If these object is observed on the Paper guide front, remove it completely. The PW snesor can not work correctly.

5.2.10 Pixel Shift Adjustment

This adjustment is made to correct the variations of ink discharged from the nozzles for Bi-D printing.



- Before starting this adjustment, make sure that Head angular adjustment and Bi-D adjustment have been made precisely.
- This adjustment is performed only in the VSD 4 print mode.
- For the Y nozzles, adjustment is not made since the adjustment result scarcely influences the image.

1. Select Pixel shift adjustment in the adjustment program.
2. Print the pixel shift adjustment check patterns, choose the pattern that has the smallest displacements in each line (except Line Y), and enter it in the adjustment program.
3. Print the check patterns again, and adjust the displacement amount.

The following shows the pixel shift adjustment check patterns.

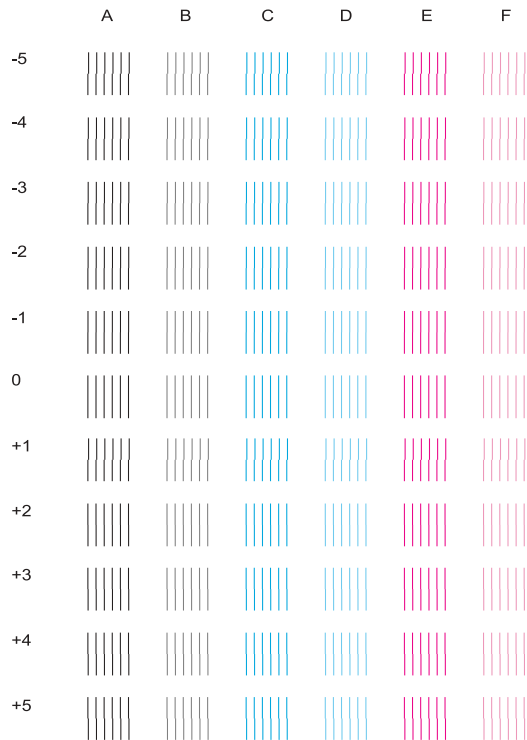


Figure 5-23. Pixel Shift Adjustment Check Patterns

5.2.11 Cut Position Adjustment

This adjustment is made to correct the roll paper cut position accuracy when the Auto cutter is fitted.



- Perform this adjustment only when the Auto cutter of the user is packed with the product to be repaired.
- This adjustment can also be made from the printer driver utility.
- Before starting this adjustment, set the Auto cutter and roll to the printer.

1. From the adjustment program, click the Print button to print the check patterns. The roll paper is transferred and the Auto cutter cuts the print patterns automatically.

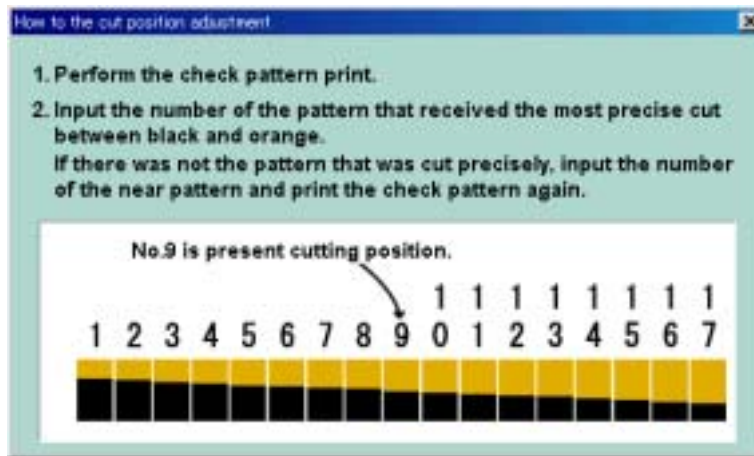


Figure 5-24. Roll Cut Position Adjustment Patterns

2. Choose the pattern number whose cut position is the closest to the color boundary position of each pattern, and enter it from the program. The correction value is saved into the EEPROM.

5.2.12 USB ID Input

This function is executed to make this product recognizable if it is connected to the PC via a USB hub.

1. Select USB ID input in the adjustment program.
2. Enter the 10-digit serial number from the label applied to the bottom side of the Rear housing.

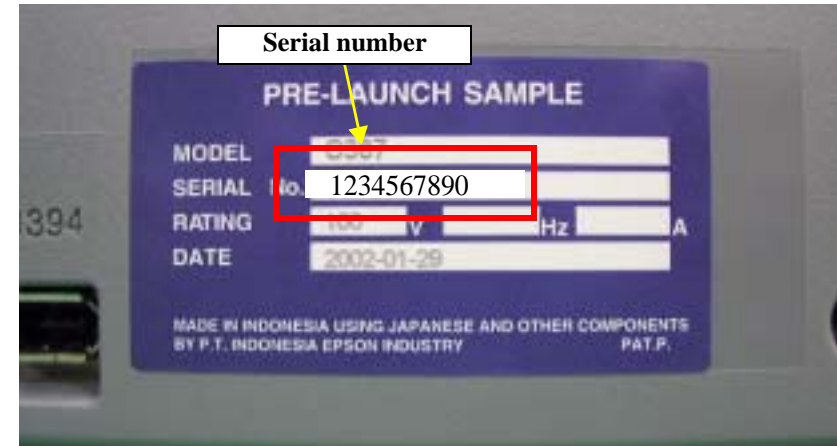


Figure 5-25. Serial Number

5.2.13 IEEE-1394 ID Input

This function is executed to make this product recognizable in the IEEE-1394 connection environment.

1. Select IEEE-1394 ID input in the adjustment program.
2. Enter the 10-digit code of the IEEE-1394 QR label applied to the rear left side as seen from the printer front. Enter the IEEE-1394 ID from left to right.

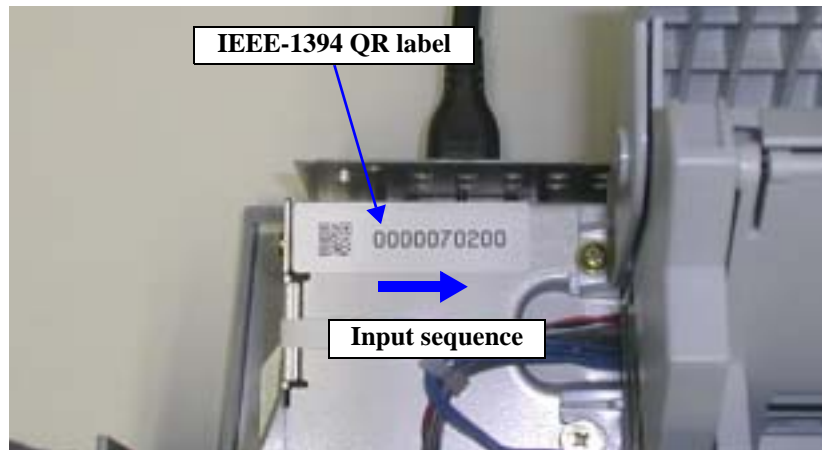


Figure 5-26. QR Label

5.2.14 First dot position adjustment (Left/Right Margin Adjustment)

This function is designed to adjust the print starting position in the CR main scanning direction.

CHECK
POINT



Though the print starting position in the CR main scanning direction is fixed to each model, this function is used to make adjustment only when a complaint is filed in repairing.

1. Choose Left/right margin adjustment in the adjustment program.
2. Click the Print button to print, and determine the correction value in the shifting direction for the pattern printed on the left margin. Correction can be made in 0.0088mm increments for the correction value of 1.

CHECK
POINT



- When replacing the Mechanism, basically peel off the IEEE1394 label carefully from the old Mechanism and apply it to the position of the new Mechanism shown above. In the ASP mechanism where the IEEE1394 label is applied in the specified position, it is also recommended to peel the label of the old Mechanism and apply it to the specified position of the ASP mechanism (new Mechanism). If the IEEE-1394 ID code has changed before and after repair, the printer is recognized as a new output terminal when it is connected to the user PC, and a new port driver is generated. In this case, the registry area of the user PC may be reduced. Therefore, we recommend you to use the above servicing method.

5.2.15 A3+ Photo Quality Ink Jet Paper 2 Print Pattern Printing Function

This function is designed to check whether all adjustment results are normal or not.



For this pattern printing, use Photo quality ink jet paper.

This function prints the following patterns. The check point in each pattern is as follows.

- Protection counter

The counter that indicates the amount of ink discharged to the Waste ink pads is printed in decimal. The counter can count up to 60352, but if the count is more than 42200, contact and notify the user that the Waste ink pads should be replaced soon, and recommend the user to change the Pads.
- Solid print patterns

This pattern is to print to stabilize the printing before printing the check patten and adjusted patern. This pattern is not printed to check the printing quality. Therefore, there is no necessity to check this pattern.

This pattern is composed with VSD1 360 dpi x 360 dpi mode and is not enough to fill out the each dot space on the Photo Quality Ink Jet Paper.

So, the uneven printing or white line will be appeared on the Photo Quality Ink Jet Paper. Especially, if the Platen Gap is set to + position, the uneven printing occurred certainly.
- Dot check patterns

In these patterns, check the dots for thin or thick dots, density inconsistency, vertical alignment, satellite, and missing dots. Print each color in three different dot patterns in order of VSD 1, VSD 2 and VSD 4 of BK from top left to right. If any pattern is found abnormal, perform Head cleaning. If the problem still persists, change the Head.
- Head angle check patterns

Make sure that each light magenta line are located at the center of black lines.
- Bi-D adjustment patterns

Make sure that there are no displacements between the vertical rules of each VSD.
- PG parallelism check patterns

Make sure that the CR main shaft and sub shaft are parallel with each other. (Whether the left and right of the shafts are parallel can also be checked.) Make sure that there are no gap and overlap between the print pattern blocks. (Gap and overlap specifications: Within 0.18mm)
- Head ID

The Head ID value saved in the EEPROM is printed.
- USB ID

The USB ID value saved in the EEPROM is printed.
- PF measurement value

The mechanical load in the PF motor ring line is printed.

If the value is as indicated below, check for lubrication, foreign matter, etc. since the mechanical load is large in the PF ring line. Replace the PF motor as required.

 - When the Cutter is not fitted, the PF measurement value in the ES 3 mode is near to 79 (if it is 79, Fatal error occurs).
- Destination

The destination set in the adjustment program is printed.
- Remaining ink amount

The remaining ink amount of each Ink cartridge currently loaded is printed in percentage. (100% is displayed if the cartridge is not yet used.)

5.2.16 A4 Plain Paper print check pattern

This function is designed to check whether the following adjustment results are normal or not.

PW sensor operation check pattern

This is to check the clipping function of the PW sensor.

The gray rectangle pattern is printed as first check pattern. If the left margin is not 3.0mm, perform the PW sensor adjustment again.



The specification for the PW sensor operation (clipping function) was changed in the firmware later the TH00D ROM (Version EL3025). As for the detail, refer to the Technical Information TE02-130 Rev.A)

Due to this modification, the PW sensor operation check pattern in the Adjustment Program was also changed later Ver. 1.1.

When the Ver. 1.1 Adjustment program is used on product, The check point is different between old firmware and new firmware as follows.

	Home position side	80 Col. side
Old (before TH00C)	3mm margin	3mm margin
New (later TH00D)	No margin	3mm margin

If the Ver.1.0 Adjustment Program is used for the new firmware, the clipping function can not be checked. So, Do not use the Ver.1.0 Adjustment Program.

PF Adjustment check pattern.

The blue PF adjustment pattern is printed as second check pattern. If the printed patters have a following condition, perform the PF adjustment again.

- Each printed patter is overlapped.
- There is gap between each printed patterns.

CHAPTER

6

MAINTENANCE

6.1 Overview

This section provides information to maintain the printer in its optimum condition.

6.1.1 ROM Replacement

This printer may require the ROM to be replaced when program changes or additions are made. In such cases, use the special tool (ROM puller: 2035659 (#F749)) to replace the ROM. The position of the ROM is shown in the figure below.

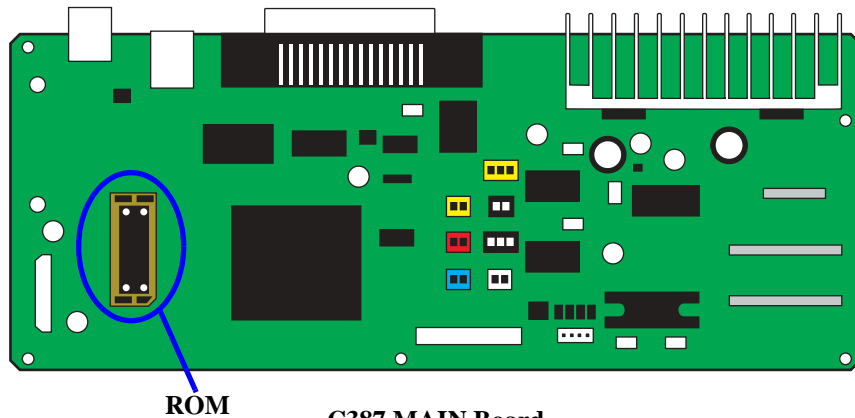


Figure 6-1. ROM Location

When installing the ROM into the socket, fit the glossy "O"-marked edges on the four corners of the ROM into the notches of the socket.

6.1.2 Cleaning

This printer has no mechanical components which require regular cleaning except the printhead. Therefore, when returning the printer to the user, check the following parts and perform appropriate cleaning if stain is noticeable.



- Never use chemical solvents, such as thinner, benzene, and acetone to clean the exterior parts of the printer like the housing. These chemicals may deform the components of the printer or deteriorate the quality of the printer.
- Be careful not to damage any components when you clean inside the printer.
- Do not scratch the surface of the PF roller assembly. Use a soft brush to wipe off dust.
- Use a soft cloth moistened with dilute alcohol to remove ink stain.
- Do not use the supplied cleaning sheet for normal usage. It may damage the coated surface of the PF roller.
- If the adhesive surface of the cleaning sheet is set to the ASF LD roller side and used to clean the ASF LD roller surface, it is no problem.

Housing

Use a clean soft cloth moistened with water and wipe off any dirt. If the Housings are stained with ink, use a cloth moistened with neutral detergent to wipe it off.

Inside the printer

Use a vacuum cleaner to remove any paper dust.

Paper eject rollers

If ink is transferred from the Paper eject rollers to a sheet of plain paper other than the Epson-specified paper during printing of a pattern as shown in Figure 6-2, moisten the cleaning pad with water using the supplied cleaning kit, then start the roller cleaning mode, and apply the cleaning pad to the Paper eject rollers to clean them.

(Refer to 1.3.11 "Panel Operation in Roller Cleaning Mode" on page 34.)

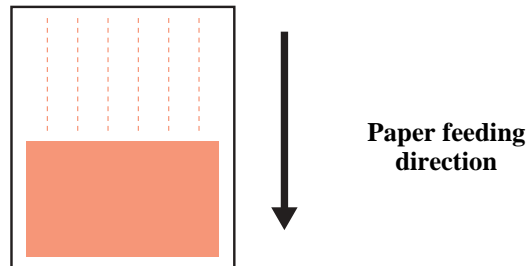


Figure 6-2. Printing Pattern Where Paper Eject Roller Marks Occur

6.1.3 Service Maintenance

If print irregularity (missing dot, white line, etc.) has occurred or the printer indicates "Maintenance Error", take the following actions to clear the error.

6.1.3.1 Head Cleaning:

The printer has a built-in head cleaning function, which is activated by operating the control panel.

- Confirm that the printer is in stand-by state

The POWER indicator is not blinking

- Hold down the Ink SW on the control panel for more than 3 seconds.

The POWER indicator blinks during the cleaning sequence.

- * For head cleaning, it is recommended to alternate the nozzle check pattern and cleaning to minimize ink consumption.

6.1.3.2 Maintenance Request

Ink is used for operations such as head cleaning as well as printing. In that case, the ink is drained into the Waste ink pad and its amount is counted by the Protection counter A (Waste ink counter) set in the EEPROM on the control board. When the preset value is reached, the Waste ink counter detects that the Waste ink pad has reached its predetermined limit, and the printer displays "Maintenance request" to indicate that the Waste ink pad should be replaced.

- Protection Counter A Limit:
Up to 60352
- Timing for Replacing the Waste Ink Pad:
 - When the Protection counter A reaches the above level, the printer displays "Maintenance request" and does not accept switch inputs except the power switch.
 - You can check the value of the Protection counter A in Chapter 5 "ADJUSTMENT".
During repair servicing, therefore, check the counter independently of the repair items. If the Protection counter A value of the printer is close to its limit, notify your customer and recommend that the Waste ink pad be replaced (if the Waste ink pad is not replaced at that time, the printer is expected to be returned for repair in the near future due to a "Maintenance request" error). Once you have the confirmation of the customer, replace the Waste ink pad and reset the counter.
 - Under the specific conditions, the limit level of the counter is preset to 25000 pages for black ink or to 10000 pages for color ink. We assume that the limit level will be reached in about 5 years in normal use.
- Replacement Procedure:
Replacement of Waste Ink Pad in Disassembly and Assembly (Refer to 4.2.3 "Removing the Waste Ink Pads" on page 131.)
- After the Replacement:
 - Reset the Protection Counter A (Refer to Chapter 5 "ADJUSTMENT")
 - Panel Operation (Refer to 1.3.6 "Special Setting Mode Function" on page 29.)

6.1.4 Lubrication

The lubrication used for the components of the printer has been decided on based on evaluation carried out by Epson. As a result, the specified amount of lubricant should be applied in the places specified when carrying out repair and maintenance work.



- Never use oil or grease other than those specified in this manual. Use of different types of oil or grease may damage the components or affect the printer functions.
- Never apply a larger amount of oil or grease than specified in this manual.

Table 6-1. Oil Applied to the Stylus PHOTO 2100/2200

Type	Name	EPSON CODE	Supplier
Grease	G-26	B702600001	EPSON
Grease	G-45	T.B.D	EPSON
Grease	G-56	1059150	EPSON
Oil	O-12	1038991	EPSON

Table 6-2. Lubrication Points

Ref. No.	Lubrication Type/Point	Remarks
1	<ul style="list-style-type: none"> <input type="checkbox"/> <Lubrication Point> Inside the bush 12 (right) mounted on the frame (middle). <input type="checkbox"/> <Lubrication Type> G-26 <input type="checkbox"/> <Lubrication Amount> φ1mm x 3mm 	Use a brush to apply it. Refer to Figure 6-3.
2	<ul style="list-style-type: none"> <input type="checkbox"/> <Lubrication Point> Driven Pully Holder <input type="checkbox"/> <Lubrication Type> G-26 <input type="checkbox"/> <Lubrication Amount> φ1mm x 2mm x 8 points 	Refer to Figure 6-4.

Table 6-2. Lubrication Points

Ref. No.	Lubrication Type/Point	Remarks
3	<input type="checkbox"/> <Lubrication Point> Driven pulley <input type="checkbox"/> <Lubrication Type> G-26 <input type="checkbox"/> <Lubrication Amount> φ1mm x 1mm x 3 points	Refer to Figure 6-5.
4	<input type="checkbox"/> <Lubrication Point> Inside diameter of combination gear 12, 22.4 <input type="checkbox"/> <Lubrication Type> O-12 <input type="checkbox"/> <Lubrication Amount> Entire periphery of inside diameter	Use a dispenser to apply it. Refer to Figure 6-6.
5	<input type="checkbox"/> <Lubrication Point> Inside diameter of combination gear 14, 28 <input type="checkbox"/> <Lubrication Type> O-12 <input type="checkbox"/> <Lubrication Amount> Entire periphery of inside diameter	Use a dispenser to apply it. Refer to Figure 6-6.
6	<input type="checkbox"/> <Lubrication Point> 25.6 side tooth surfaces of Combination gear 17.19, 25.6 <input type="checkbox"/> <Lubrication Type> G-26 <input type="checkbox"/> <Lubrication Amount> φ0.5mm x 10mm (4 surfaces)	Refer to Figure 6-6.
7	<input type="checkbox"/> <Lubrication Point> ASF motor mounting plate B shaft <input type="checkbox"/> <Lubrication Type> G-26 <input type="checkbox"/> <Lubrication Amount> φ1mm x 4mm	Use a brush to apply it. When mounting the Combination gear 17.19, 25.6, be careful not to spread oil toward the motor. Refer to Figure 6-6.

Table 6-2. Lubrication Points

Ref. No.	Lubrication Type/Point	Remarks
8	<input type="checkbox"/> <Lubrication Point> Felts D3.6 of Combination gears 12, 22.4 and 14, 28 <input type="checkbox"/> <Lubrication Type> O-12 <input type="checkbox"/> <Lubrication Amount> Immerse them in O-12.	Wipe them so that excess oil will not go into the motor. Refer to Figure 6-6.
9	<input type="checkbox"/> <Lubrication Point> Paper eject rollers A, B and EJ grounding spring engagement <input type="checkbox"/> <Lubrication Type> G-26 <input type="checkbox"/> <Lubrication Amount> φ1mm x 52mm	Refer to Figure 6-7.
10	<input type="checkbox"/> <Lubrication Point> Paper guide rear and PF roller engagement <input type="checkbox"/> <Lubrication Type> G-26 <input type="checkbox"/> <Lubrication Amount> φ0.5mm x 5 +/- 2mm	<input type="checkbox"/> Using the spur gear tool, apply grease while rotating the Spur gear 76. <input type="checkbox"/> Avoid applying grease to the specially coated surface of the PF roller. Refer to Figure 6-8.
	<input type="checkbox"/> <Lubrication Point> PF roller and PF grounding spring <input type="checkbox"/> <Lubrication Type> G-26 <input type="checkbox"/> <Lubrication Amount> φ1mm x entire PF roller periphery	<input type="checkbox"/> Using the spur gear tool, apply grease while rotating the Spur gear 76. Refer to Figure 6-8.

Table 6-2. Lubrication Points

Ref. No.	Lubrication Type/Point	Remarks
11	<input type="checkbox"/> <Lubrication Point> Hook of Paper guide lower <input type="checkbox"/> <Lubrication Type> G-45 <input type="checkbox"/> <Lubrication Amount> φ1mm x 1mm x 4 points	Refer to Figure 6-9.
12	<input type="checkbox"/> <Lubrication Point> Hook that engages the Paper eject roller shaft B and Paper guide lower. <input type="checkbox"/> <Lubrication Type> G-45 <input type="checkbox"/> <Lubrication Amount> φ1mm x 2mm x 5 points	Refer to Figure 6-10.
13	<input type="checkbox"/> <Lubrication Point> Groove of Release lever shaft <input type="checkbox"/> <Lubrication Type> G-26 <input type="checkbox"/> <Lubrication Amount> φ1mm x 10mm x 2 points	Refer to Figure 6-11.
	<input type="checkbox"/> <Lubrication Point> Hook of Frame upper that engages with the Release lever shaft (3 places) <input type="checkbox"/> <Lubrication Type> G-26 <input type="checkbox"/> <Lubrication Amount> φ1mm x 10mm x 2 points	Refer to Figure 6-11.

Table 6-2. Lubrication Points

Ref. No.	Lubrication Type/Point	Remarks
14	<input type="checkbox"/> <Lubrication Point> 5 places of Paper guide front <input type="checkbox"/> <Lubrication Type> G-26 <input type="checkbox"/> <Lubrication Amount> 1) φ1mm x 2mm x 4 points: Paper eject roller side 2) φ1mm x 10mm x 1 point: PF roller assembly side	Do not apply grease to the rubber rollers of the Paper eject rollers. Refer to Figure 6-12.
15	<input type="checkbox"/> <Lubrication Point> Shaft of Combination gear lever Assy <input type="checkbox"/> <Lubrication Type> G-26 <input type="checkbox"/> <Lubrication Amount> φ1mm x 4mm	Use a brush to apply it. Refer to Figure 6-13.
16	<input type="checkbox"/> <Lubrication Point> Oil pad <input type="checkbox"/> <Lubrication Type> O-12 <input type="checkbox"/> <Lubrication Amount> 0.655cc	<input type="checkbox"/> Lubricate only at the following timings. <ul style="list-style-type: none"> • Replacement of Carriage unit • Replacement of Oil pad <input type="checkbox"/> Use a dispenser to lubricate. If much oil is applied, dispose of that pad and lubricate a new pad. <input type="checkbox"/> After lubrication, leave the pad to stand for 1 minute, and mount it to the Carriage unit with the lubricated surface located on the CR guide shaft side. Refer to Figure 6-14.

Table 6-2. Lubrication Points

Ref. No.	Lubrication Type/Point	Remarks
16	<input type="checkbox"/> <Lubrication Point> Oil pad ring <input type="checkbox"/> <Lubrication Type> O-12 <input type="checkbox"/> <Lubrication Amount> 0.22cc	<input type="checkbox"/> Lubricate only at the following timings. <ul style="list-style-type: none"> • Replacement of Carriage unit • Replacement of Oil pad ring <input type="checkbox"/> Pour the specified oil in a clean pan-shaped vessel and immerse the pad there for 1 minute. <input type="checkbox"/> After lubrication, leave the pad ring to stand for 1 minute, and mount it to the carriage unit with the lubricated surface located on the CR guide shaft side. Refer to Figure 6-14.
17	<input type="checkbox"/> <Lubrication Point> Feed roller assembly mounting hole in the right side of the ASF frame <input type="checkbox"/> <Lubrication Type> G-26 <input type="checkbox"/> <Lubrication Amount> Entire periphery of inside diameter	Refer to Figure 6-15.
	<input type="checkbox"/> <Lubrication Point> Portion that slides with the Release hopper lever of the Hopper assembly (2 places) <input type="checkbox"/> <Lubrication Type> G-26 <input type="checkbox"/> <Lubrication Amount> φ1mm x 10mm x 2 points	Refer to Figure 6-15.

Table 6-2. Lubrication Points

Ref. No.	Lubrication Type/Point	Remarks
18	<input type="checkbox"/> <Lubrication Point> PG change spring lever mounting hole outside diameter <input type="checkbox"/> <Lubrication Type> G-26 <input type="checkbox"/> <Lubrication Amount> φ1mm x entire periphery of outside diameter	Place the adjust lever in the far side position and apply grease. Refer to Figure 6-16.
19	<input type="checkbox"/> <Lubrication Point> Tooth surfaces of Release levers and Release connection lever <input type="checkbox"/> <Lubrication Type> G-26 <input type="checkbox"/> <Lubrication Amount> 1) Release connection lever: φ1mm x entire periphery of tooth surface 2) Release lever (front side): φ1mm x 3/4 tooth surface 3) Release lever (far side): φ1mm x 10mm	Place the Release levers in the front and far side positions and apply grease. Refer to Figure 6-17.
20	<input type="checkbox"/> <Lubrication Point> Combination gear 17, 24.5 bearing <input type="checkbox"/> <Lubrication Type> G-26 <input type="checkbox"/> <Lubrication Amount> φ1mm x 5mm	Refer to Figure 6-18.
21	<input type="checkbox"/> <Lubrication Point> Holes of left parallelism adjust bush and sub-left parallelism adjust bush <input type="checkbox"/> <Lubrication Type> G-26 <input type="checkbox"/> <Lubrication Amount> Entire periphery of inside diameter	Apply grease to the entire periphery. Refer to Figure 6-19.

Table 6-2. Lubrication Points

Ref. No.	Lubrication Type/Point	Remarks
22	<ul style="list-style-type: none"> <input type="checkbox"/> <Lubrication Point> Holes of right parallelism adjust bush and sub-right parallelism adjust bush <input type="checkbox"/> <Lubrication Type> G-26 <input type="checkbox"/> <Lubrication Amount> Entire periphery of inside diameter 	<p>Apply grease to the entire periphery.</p> <p>Refer to Figure 6-20.</p>
23	<ul style="list-style-type: none"> <input type="checkbox"/> <Lubrication Point> Portions where both sides of the CR guide shaft B make contact with the Slider CR <input type="checkbox"/> <Lubrication Type> G-56 <input type="checkbox"/> <Lubrication Amount> 1) $\phi 3\text{mm} \times 30\text{mm}$: CR guide shaft B left side 2) $\phi 3\text{mm} \times 30\text{mm}$: CR guide shaft B right side 	<p>Refer to Figure 6-21.</p> <ul style="list-style-type: none"> <input type="checkbox"/> Place the Adjust lever in the front side position, move the Carriage unit to the center, and apply grease from both ends of the Carriage unit to between both ends of the Housing upper fixing frame. <input type="checkbox"/> Place the Release lever in the far side position, move the left end of the Carriage unit from the left end of the Housing upper fixing frame to a $\pm 30\text{mm}$ position, and apply grease.



- Never lubricate the CR guide shaft A directly. Doing so will give critical faults to the main components of the printer.
- Never apply an excessive amount of oil to the oil pad. Doing so will give critical faults to the main components of the printer.

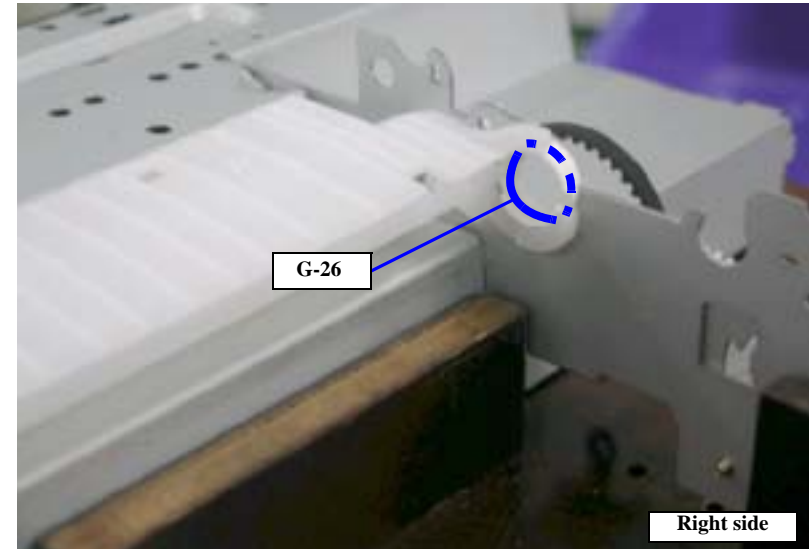


Figure 6-3. Lubrication Point 1

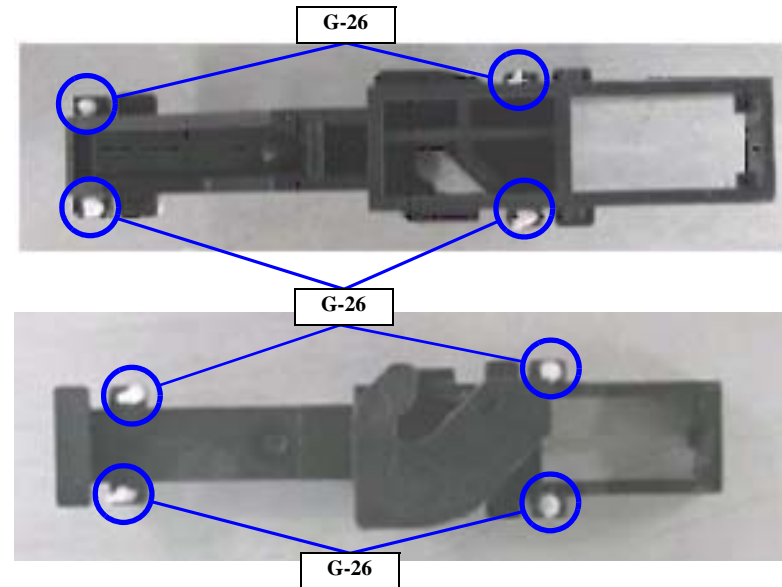


Figure 6-4. Lubrication Point 2

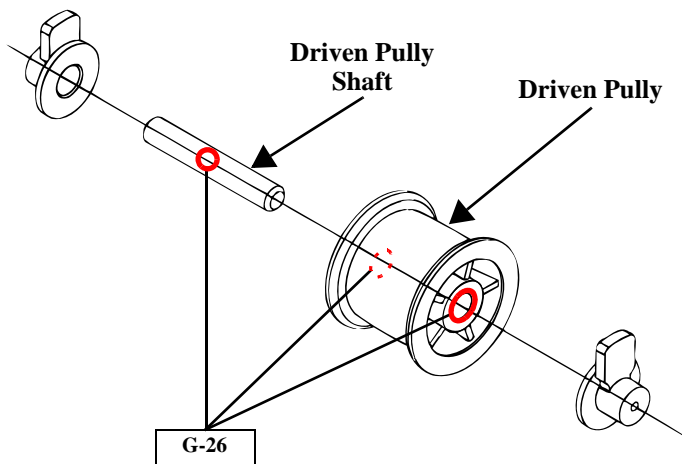


Figure 6-5. Lubrication Point 3

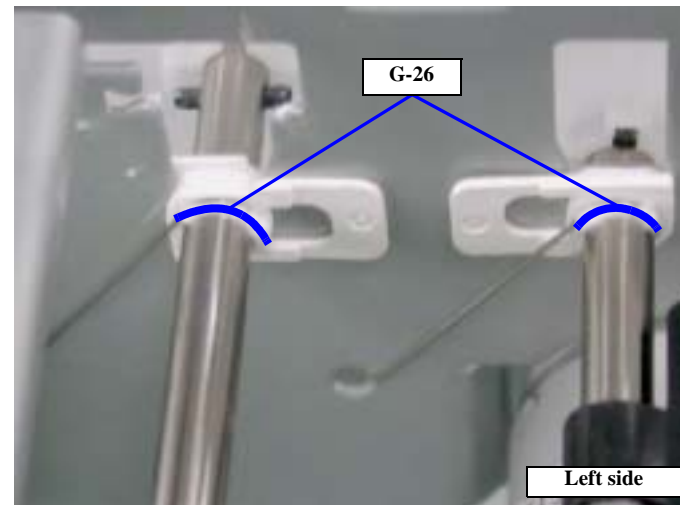


Figure 6-7. Lubrication Point 9

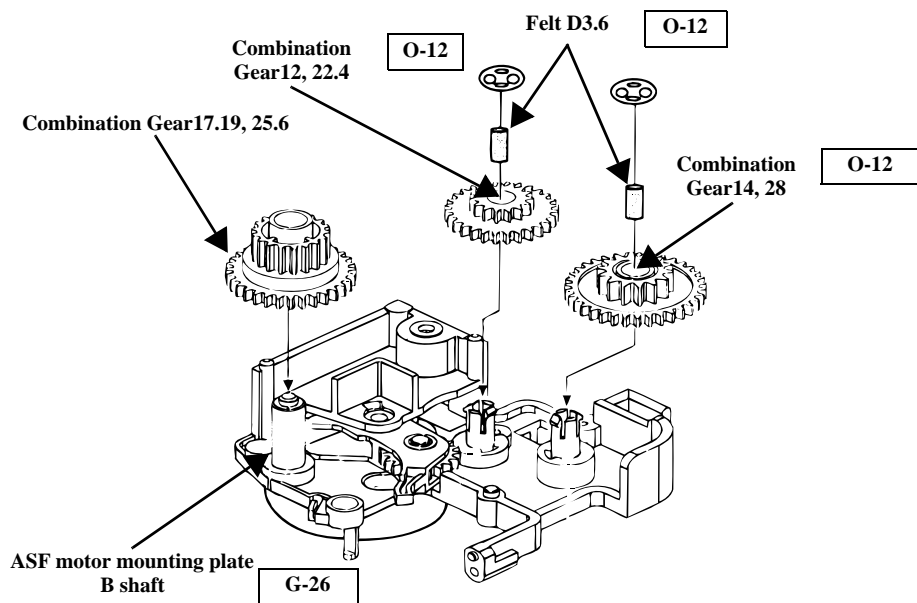


Figure 6-6. Lubrication Point 4, 5, 6, 7, 8

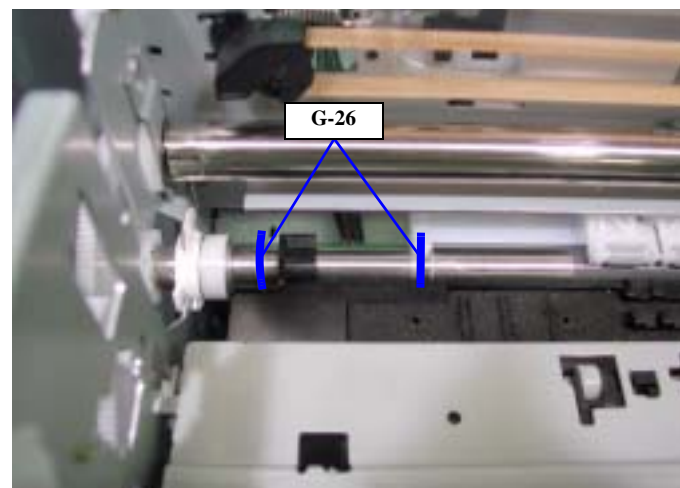


Figure 6-8. Lubrication Point 10

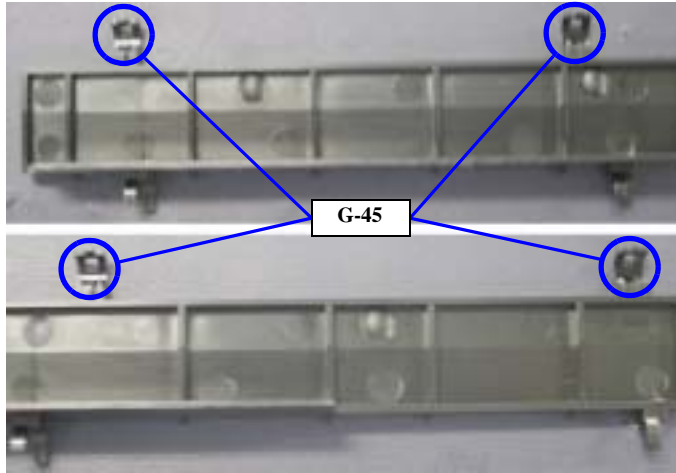


Figure 6-9. Lubrication Point 11

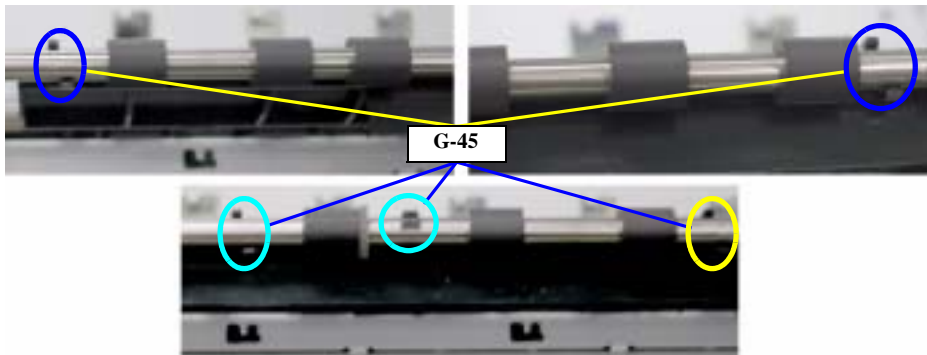


Figure 6-10. Lubrication Point 12

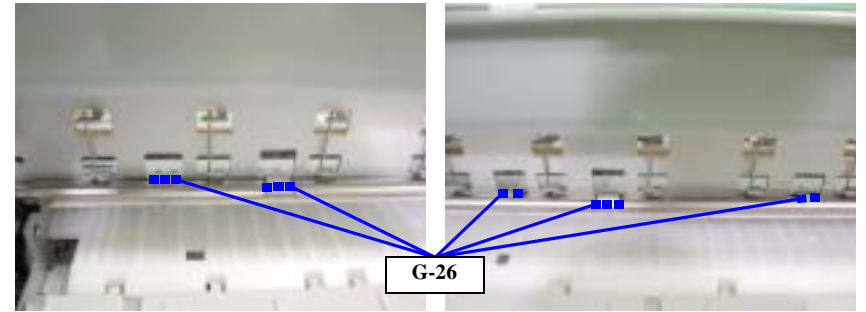


Figure 6-11. Lubrication Point 13

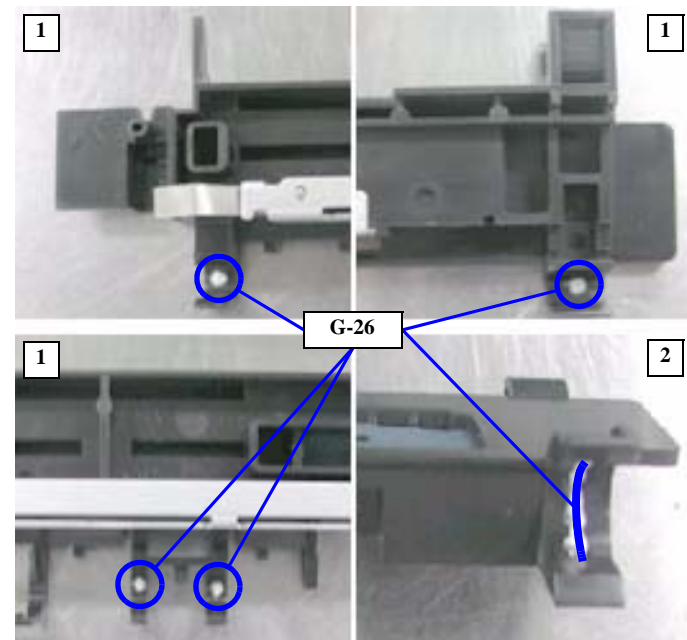


Figure 6-12. Lubrication Point 14

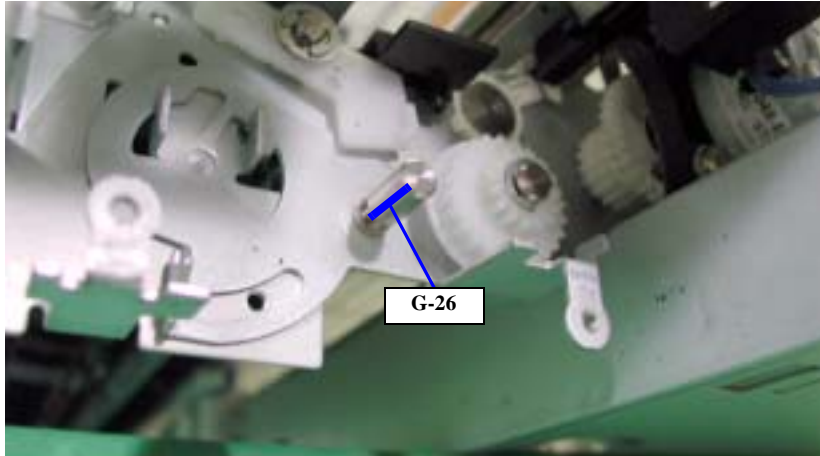


Figure 6-13. Lubrication Point 15

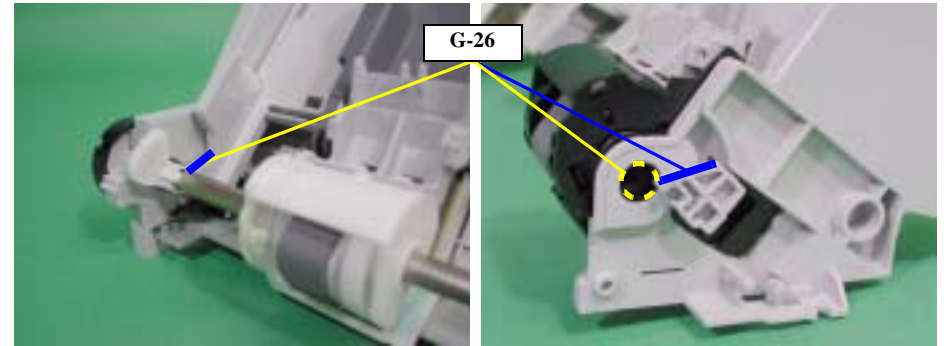


Figure 6-15. Lubrication Point 17

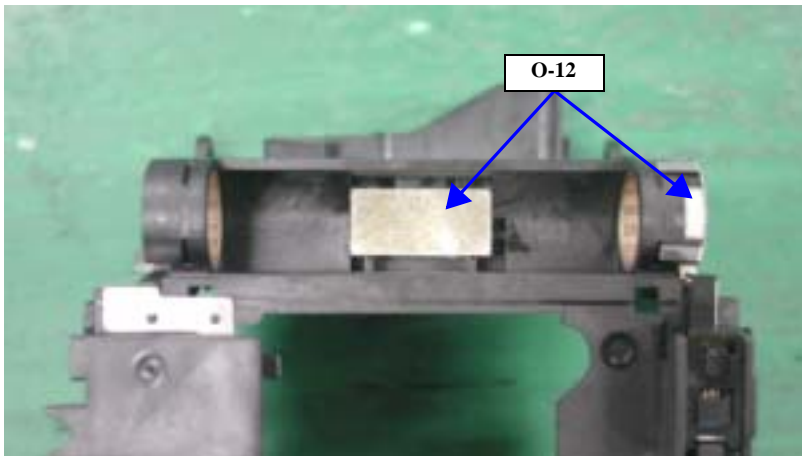


Figure 6-14. Lubrication Point 16

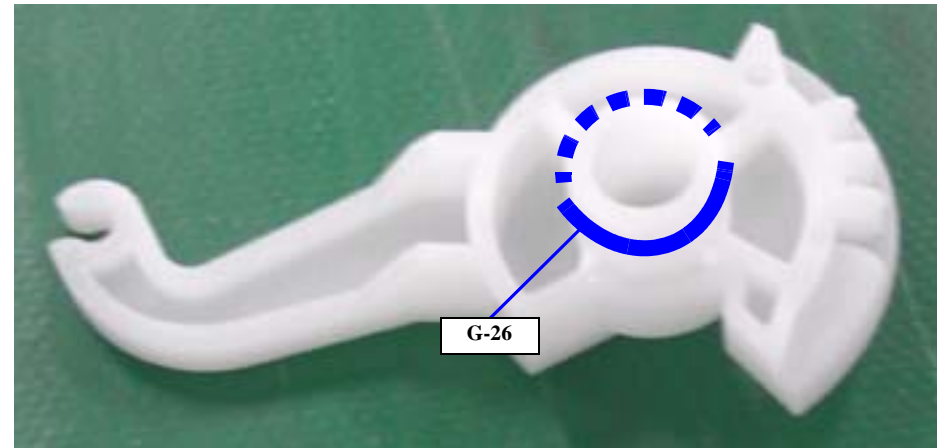


Figure 6-16. Lubrication Point 18

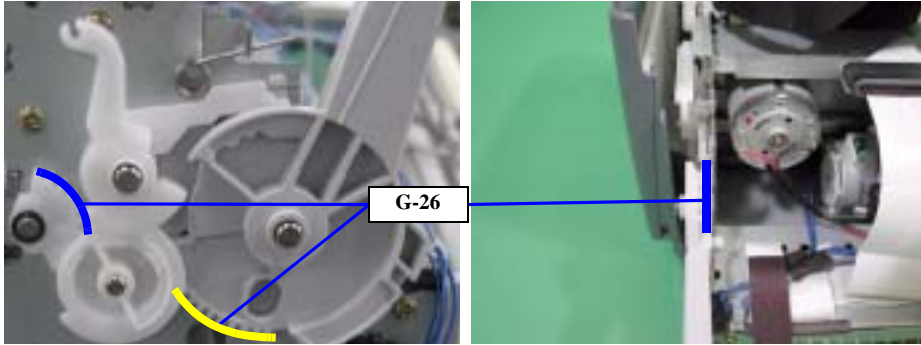


Figure 6-17. Lubrication Point 19

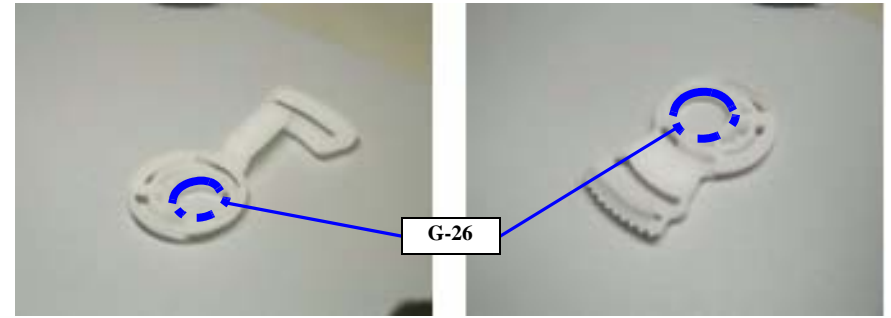


Figure 6-20. Lubrication Point 22

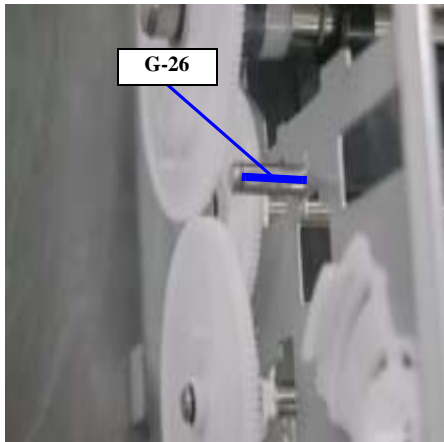


Figure 6-18. Lubrication Point 20

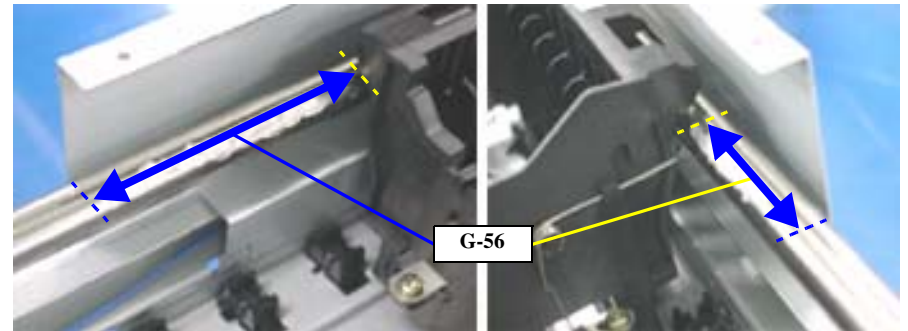


Figure 6-21. Lubrication Point 23

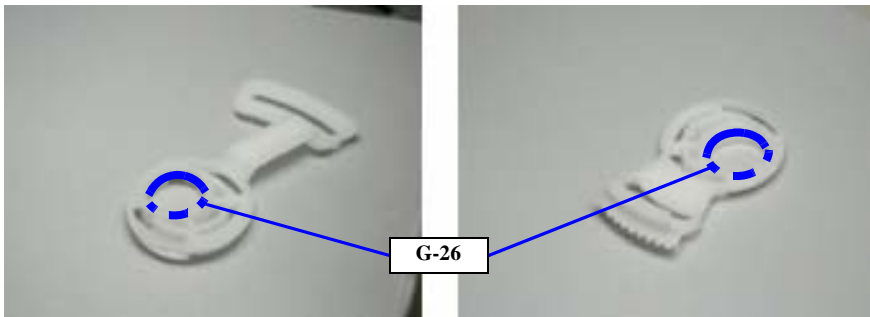


Figure 6-19. Lubrication Point 21

CHAPTER

7

APPENDIX

7.1 Connector Summary

This section shows the connections between the main components of the printer.

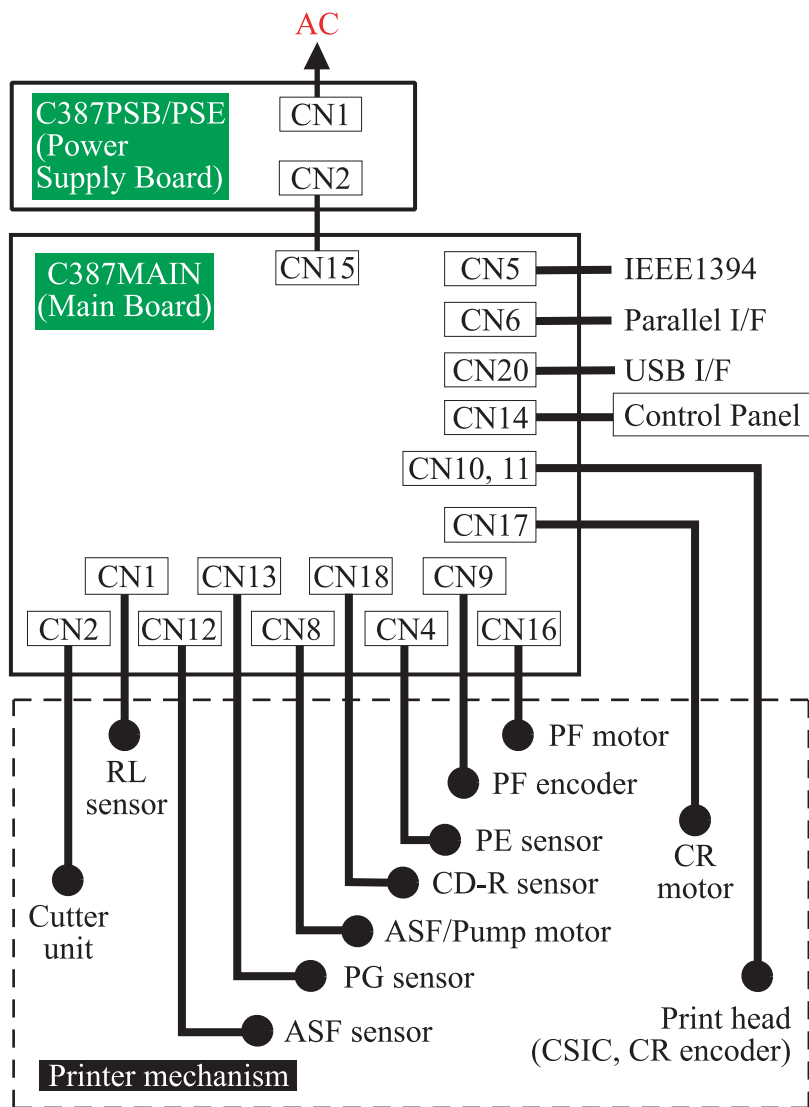


Figure 7-1. Connection of the Major Components

7.1.1 Connectors and Pin Layouts

See the following tables for the connector summary for the C387 MAIN board and each connector's pin alignment.

Table 7-1. Connector Summary for C387 MAIN

Connector	Function	Ref.
CN1	Release sensor	Table 7-2
CN2	Cutter unit	Table 7-3
CN4	PE sensor	Table 7-4
CN8	ASF/Pump motor	Table 7-5
CN9	PF encoder	Table 7-6
CN10	Printhead (including CR encoder input and head temperature)	Table 7-7
CN11	Printhead (including CSIC transmissions)	Table 7-8
CN12	ASF sensor	Table 7-9
CN13	PG sensor	Table 7-10
CN14	Panel board	Table 7-11
CN15	Power supply board	Table 7-12
CN16	PF motor	Table 7-13
CN17	CR motor	Table 7-14
CN18	CD-R sensor	Table 7-15

Table 7-2. CN1-Release sensor

Pin	Signal name	I/O	Function
1	RL	I	Detect signal for release
2	GND	-	Ground

Table 7-3. CN2-Cutter unit

Pin	Signal name	I/O	Function
1	CUT1	I	Cutter position sensor 1
2	CTON	I	Cutter unit sensor
3	CUTV	O	Power control for cutter
4	GND	-	Ground
5	+5V	-	+5V logic power supply
6	GND	-	Ground
7	CUT2	I	Cutter position sensor 2
8	IN1	O	Cutter control 1
9	IN2	O	Cutter control 2
10	CUT3	I	Cutter position sensor 3
11	NC	-	Not connected
12	NC	-	Not connected

Table 7-4. CN4-PE sensor

Pin	Signal name	I/O	Function
1	PE	I	Detect signal for PE
2	GND	-	Ground
3	PEV	-	+5V logic power supply

Table 7-5. CN8-ASF/Pump motor

Pin	Signal name	I/O	Function
1	ASFA	O	ASF/Pump motor drive signal (A)
2	ASFB	O	ASF/Pump motor drive signal (B)
3	ASF/A	O	ASF/Pump motor drive signal (/A)
4	ASF/B	O	ASF/Pump motor drive signal (/B)

Table 7-6. CN9-PF encoder

Pin	Signal name	I/O	Function
1	GND	-	Ground
2	ENB	I	Feed back signal from rotary encoder ch.B
3	VCC	-	Power supply for PF encoder sensor (+3.3V)
4	ENA	I	Feed back signal from rotary encoder ch.A
5	GND	-	Ground

Table 7-7. CN10-Printhead

Pin	Signal name	I/O	Function
1	COMY	-	Common voltage (Y)
2	GND2C	-	Ground 2C
3	GND2C	-	Ground 2C
4	COMM	-	Common voltage (M)
5	GND2Y	-	Ground 2Y
6	GND2Y	-	Ground 2Y
7	COMC	-	Common voltage (C)
8	GND2M	-	Ground 2M
9	GND2M	-	Ground 2M
10	VHV	-	Power supply for nozzle selector (+42V)
11	GND	-	Ground
12	VDD2	-	+3.3V logic power supply
13	TH	I	Thermistor detect signal

Table 7-7. CN10-Printhead

Pin	Signal name	I/O	Function
14	LAT	O	Head data latch output signal
15	GND	-	Ground
16	SCK	O	Serial clock signal
17	GND	-	Ground
18	NC	-	Not connected
19	GND	-	Ground
20	ENA	I	Feed back signal from linear encoder ch.A
21	VDD	-	+3.3V logic power supply
22	ENB	I	Feed back signal from linear encoder ch.B
23	GND	-	Ground
24	CRST	O	Reset signal for address counter of CSIC
25	GND	-	Ground
26	CSD1	O	CSIC serial data 1
27	CVDD	O	Power for CSIC memory
28	CSCK	I/O	Clock signal for CSIC read/write
29	COO	I	Cartridge detect signal
30	CSD2	O	CSIC serial data 2
31	PW	I	Detect signal for PW

Table 7-8. CN11-Printhead

Pin	Signal name	I/O	Function
1	SIB	O	Printhead data output (B)
2	SIC	O	Printhead data output (C)
3	GND	-	Ground
4	SILc	O	Printhead data output (Lc)
5	SIM	O	Printhead data output (M)
6	GND	-	Ground
7	SILm	O	Printhead data output (Lm)
8	SIY	O	Printhead data output (Y)

Table 7-8. CN11-Printhead

Pin	Signal name	I/O	Function
9	GND	-	Ground
10	SIDy	O	Printhead data output (Dy)
11	GND	-	Ground
12	CH	O	Charge signal for the trapezoidal wave-form
13	VDD3.3	-	+3.3V logic power supply
14	SP	O	SP signal
15	GND	-	Ground
16	NCHG	O	All nozzle fire selection pulse
17	ANODE	O	Abnormal temperature detection circuit for the nozzles
18	GND	-	Ground
19	COMLc	-	Common voltage (Lc)
20	GND2Lky	-	Ground 2LKy
21	GND2Lky	-	Ground 2LKy
22	COMB	-	Common voltage (B)
23	GND2Lm	-	Ground 2Lm
24	GND2Lm	-	Ground 2Lm
25	COMLk	-	Common voltage (Lk)
26	GND2Lc	-	Ground 2Lc
27	GND2Lc	-	Ground 2Lc
28	COMLm	-	Common voltage (Lm)
29	GND2B	-	Ground 2B
30	GND2B	-	Ground 2B

Table 7-9. CN12-ASF sensor

Pin	Signal name	I/O	Function
1	ASF	I	Detect signal for ASF
2	GND	-	Ground
3	ASFV	-	Power supply for ASF sensor (+5V)

Table 7-10. CN13-PG sensor

Pin	Signal name	I/O	Function
1	PG	I	Detect signal for PG
2	GND	-	Ground

Table 7-11. CN14-Panel board

Pin	Signal name	I/O	Function
1	PSC	-	Output signal from power supply switch
2	GND	-	Ground
3	SW0	I	Input signal from panel switch (0)
4	GND	-	Ground
5	SW1	I	Input signal from panel switch (1)
6	GND	-	Ground
7	SW2	I	Input signal from panel switch (2)
8	+5V	-	Power supply for panel (+5V)
9	SW3	I	Input signal from panel switch (3)
10	+5V	-	Power supply for panel (+5V)
11	LED LAT	O	Input signal from panel LED (LAT)
12	LED DAT	O	Input signal from panel LED (DAT)
13	LED CLK	O	Input signal from panel LED (CLK)

Table 7-12. CN15-Power supply board

Pin	Signal name	I/O	Function
1	+42V	-	Power supply for printer mechanism (+42V)
2	+42V	-	Power supply for printer mechanism (+42V)
3	GND	-	Ground
4	ESAVE	-	Energy save mode
5	PSC	-	Output signal from power supply switch
6	GND	-	Ground
7	GND	-	Ground
8	+5V	-	+5V logic power supply

Table 7-13. CN16-PF motor

Pin	Signal name	I/O	Function
1	PF-A	O	PF motor drive signal (A)
2	PF-B	O	PF motor drive signal (B)

Table 7-14. CN17-CR motor

Pin	Signal name	I/O	Function
1	CR-A	O	CR motor drive signal (A)
2	CR-B	O	CR motor drive signal (B)

Table 7-15. CN18-CD-R sensor

Pin	Signal name	I/O	Function
1	CDR	I	Detect signal for CD-R
2	GND	-	Ground

7.1.2 EEPROM Address Map

Table 7-16. EEPROM Address Map

Address	Explanation	Setting	QPIT setting	Factory settings
00H 01H	Password		5AH 0FH	- -
02H	Ink flag 1	bit0: CSIC Disable bit1: exchange flag 1 bit2: exchange flag 2 bit3: exchange flag 3 bit4: initial fill required bit5: ink set one-month ago bit6: replace cleaning flag 1 bit7: replace cleaning flag 2	00H	10H
03H	Ink flag 2	bit0: 1 st cartridge bit1: ink cleaning seq. bit2: reserved bit3: reserved bit4: reserved bit5: reserved bit6: reserved bit7: reserved	00H	01H
04H 07H	Ink counter Cb	Lower byte ↓ Upper byte	00H 00H	00H 00H
08H 0BH	Ink counter Clb	Lower byte ↓ Upper byte	00H 00H	00H 00H
0CH 0FH	Ink counter Cc	Lower byte ↓ Upper byte	00H 00H	00H 00H
10H 13H	Ink counter Clc	Lower byte ↓ Upper byte	00H 00H	00H 00H
14H 17H	Ink counter Cm	Lower byte ↓ Upper byte	00H 00H	00H 00H

Table 7-16. EEPROM Address Map

Address	Explanation	Setting	QPIT setting	Factory settings
18H 1BH	Ink counter Clm	Lower byte ↓ Upper byte	00H 00H	00H 00H
1CH 1FH	Ink counter Cy	Lower byte ↓ Upper byte	00H 00H	00H 00H
20H 21H	Ink counter A0	Lower byte Upper byte	00H 00H	00H ^(*3) 00H ^(*3)
22H 23H	Ink counter Fc	Lower byte Upper byte	00H 00H	00H 00H
24H 25H	Ink counter Af	Lower byte Upper byte	00H 00H	00H 00H
26H 27H	Last cleaning time	Lower byte Upper byte	00H 00H	00H ^(*2) 00H ^(*2)
28H 29H	Power off time	Lower byte Upper byte	00H 00H	00H ^(*2) 00H ^(*2)
2AH 2BH	Accumulated printing time	Lower byte Upper byte	00H 00H	00H 00H
2CH	Cleaning Counter KK		00H	00H
2DH	Reserved		-	-
2EH 2FH	Cleaning 1 Counter		00H 00H	00H 00H
30H 31H	Cleaning 2 Counter		00H 00H	00H 00H
32H 33H	Cleaning 3 Counter		00H 00H	00H 00H
34H 35H	Timer Cleaning Counter		00H 00H	00H 00H
36H 37H	Exchange Cleaning Counter		00H 00H	00H 00H

Table 7-16. EEPROM Address Map

Address	Explanation	Setting	QPIT setting	Factory settings
38H 39H	Replace Cleaning Counter		00H 00H	00H 00H
3AH	Initial Fill Counter		00H	00H
3BH	Reserved		-	-
3CH	Fatal Error Code		00H	00H
3DH	Total fever (CR)		00H	00H
3EH	Total fever (PF)		00H	00H
3FH	Roll paper flag	bit0: Roll paper mode bit1: Panel load mode	00H	00H
40H 41H	Password		5AH 0FH	- -
42H	EEPROM mapping revision		41H	-
43H	Reserved		-	-
44H	Interface selection	0:Auto 1:Parallel 3:USB1.1 4:1394 5:USB2.0	00H	00H ^(*2)
45H	Interface time-out	0 to 255 (by second, value of 0 means 10 seconds)	0AH	0AH
46H	Compatibility speed	0:Fast 1:Slow 2:Special-1 3:Special-2	00H	00H
47H	ECP speed ^(*a)	0:Fast 1:Slow	00H	00H
48H	IEEE1284.4 for Parallel	0:Auto 1:On 2:Off	00H	01H
49H	IEEE1284.4 for USB	0:Auto 1:On 2:Off	00H	01H

*a. BUSY signal delay time from fall-edge of a -STB signal. (Fast:Max.1MB/s, Slow:Max. 600KB/s)

*b. Select IEEE1284 transfer mode. (ECP or Nibble)

*c. Enable or disable reverse transfer. (when disabled, ignore -SLIN signal)

Table 7-16. EEPROM Address Map

Address	Explanation	Setting	QPIT setting	Factory settings
4AH	I/F Control flags	bit0: IEEE1284 mode (0=On, 1=Off) ^(*c) bit1: ECP mode (0=Off, 1=On) ^(*b) bit2-bit7: reserved	00H	00H
4BH 4FH	Reserved		- -	- -
50H 55H	CPSI password		00H 00H	00H 00H
56H	Print direction control	0:Bi-D 1:Uni-D 2:Auto	02H	02H
57H	CG table	08H:PC437 0AH:PC850	08H	08H
58H	Font	0:Courier	00H	00H
59H	Pitch	0:10cpi	00H	00H
5AH	Auto LF, Network I/F mode	bit0: Auto line feed (0=Off,1=On) bit1: Network I/F mode (0=Off,1=On) bit2-bit7: reserved	00H	00H
5BH	Check mod control	0:Entry Self-Test 1:Entry Hex-Dump 2:Extended settings	00H	00H
5CH	PW Adjustment (HMXU)	-8 <= n <= +8 (by 0.1411mm(1/180inch))	00H	(*1)
5DH	PW Adjustment (HMYU)	-8 <= n <= +8 (by 0.1411mm(1/180inch))	00H	(*1)
5EH	PW Adjustment (HMXD)	-8 <= n <= +8 (by 0.1411mm(1/180inch))	00H	(*1)
5FH	PW Adjustment (HMYD)	-8 <= n <= +8 (by 0.1411mm(1/180inch))	00H	(*1)

Table 7-16. EEPROM Address Map

Address	Explanation	Setting	QPIT setting	Factory settings
60H	Bi-D Adjustment for VSD1 (Bk)	-72 ≤ n ≤ +72 (by 0.00882mm(1/2880inch))	00H	(*1)
61H	Bi-D Adjustment for VSD2 (Bk)	-72 ≤ n ≤ +72 (by 0.00882mm(1/2880inch))	00H	(*1)
62H	Bi-D Adjustment for VSD2 (Bk)	-72 ≤ n ≤ +72 (by 0.00882mm(1/2880inch))	00H	(*1)
63H	Bi-D Adjustment for VSD4 (Bk)	-72 ≤ n ≤ +72 (by 0.00882mm(1/2880inch))	00H	(*1)
64H	Bi-D Adjustment for VSD1 (Cl)	-72 ≤ n ≤ +72 (by 0.00882mm(1/2880inch))	00H	(*1)
65H	Bi-D Adjustment for VSD2 (Cl)	-72 ≤ n ≤ +72 (by 0.00882mm(1/2880inch))	00H	(*1)
66H	Bi-D Adjustment for VSD2 (Cl)	-72 ≤ n ≤ +72 (by 0.00882mm(1/2880inch))	00H	(*1)
67H	Bi-D Adjustment for VSD4 (Cl)	-72 ≤ n ≤ +72 (by 0.00882mm(1/2880inch))	00H	(*1)
68H	1 st Dot Position Adjustment	-72 ≤ n ≤ +72 (by 0.00882mm(1/2880inch))	00H	(*1)
69H	Cut Position Adjustment		00H	00H
6AH	PF Cutter Measurement 1 (ES3)		00H	06H
6BH	PF Cutter Measurement 2 (ES5)		00H	06H
6CH 6DH	CR Measurement Data	Lower byte Upper byte	00H 00H	(*1) (*1)
6EH 6FH	Cut Count	Lower byte Upper byte	00H 00H	00H 00H
70H 71H	Top margin	42 to 44 x 360 (by 0.0706mm(1/360inch))	78H 00H	78H 00H
72H 73H	Bottom margin	1244 to 44 x 360 (by 0.0706mm(1/360inch))	F0H 1EH	F0H 1EH

Table 7-16. EEPROM Address Map

Address	Explanation	Setting	QPIT setting	Factory settings
74H 75H	Page length	1244 to 44 x 360 (by 0.0706mm(1/360inch))	F0H 1EH	F0H 1EH
76H	PW Detect Level		-	-
77H	PF Adjustment	-4 ≤ n ≤ +4 (by 0.01764mm(1/1440inch))	00H	(*1)
78H 7BH	Accumulate Page Counter (by 1page)	Lower byte ↓ Upper byte	00H 00H	00H 00H
7CH 7FH	Accumulate Print Pass (by 1pass)	Lower byte ↓ Upper byte	00H 00H	00H 00H
80H 81H	Password		5AH 0FH	- -
82H	Head ID for VH1LC	+1 ≤ n ≤ +201	00H	(*1)
83H	Head ID for VH2LC	+1 ≤ n ≤ +201	00H	(*1)
84H	Head ID for VH2SC	+1 ≤ n ≤ +201	00H	(*1)
85H	Head ID for VH4SC	+1 ≤ n ≤ +201	00H	(*1)
86H	Color adjust ID1 for IwK1		00H	(*1)
87H	Color adjust ID1 for IwLK1		00H	(*1)
88H	Color adjust ID1 for IwC1		00H	(*1)
89H	Color adjust ID1 for IwLC1		00H	(*1)
8AH	Color adjust ID1 for IwM1		00H	(*1)
8BH	Color adjust ID1 for IwLM1		00H	(*1)
8CH	Color adjust ID1 for IwY1		00H	(*1)
8DH	Color adjust ID2 for IwK2		00H	(*1)
8EH	Color adjust ID2 for IwLK2		00H	(*1)
8FH	Color adjust ID2 for IwC2		00H	(*1)
90H	Color adjust ID2 for IwLC2		00H	(*1)

Table 7-16. EEPROM Address Map

Address	Explanation	Setting	QPIT setting	Factory settings
91H	Color adjust ID2 for IwM2		00H	(*1)
92H	Color adjust ID2 for IwLM2		00H	(*1)
93H	Color adjust ID2 for IwY2		00H	(*1)
94H	Head ID for IwVSD2M		00H	(*1)
95H	Head ID for Tc	0 <= n <= +2	00H	(*1)
96H	Head ID for TG	0 <= n <= +3	00H	(*1)
97H	Shift Pixel adjust for A-line	-128 <= n <= +127 by 1 pixel	00H	(*1)
98H	Shift Pixel adjust for B-line	-128 <= n <= +127 by 1 pixel	00H	(*1)
99H	Shift Pixel adjust for C-line	-128 <= n <= +127 by 1 pixel	00H	(*1)
9AH	Shift Pixel adjust for D-line	-128 <= n <= +127 by 1 pixel	00H	(*1)
9BH	Shift Pixel adjust for E-line	-128 <= n <= +127 by 1 pixel	00H	(*1)
9CH	Shift Pixel adjust for F-line	-128 <= n <= +127 by 1 pixel	00H	(*1)
9DH	Shift Pixel adjust for G-line	-128 <= n <= +127 by 1 pixel	00H	(*1)
9EF 9FH	Reserved		- -	- -
A0H	CSIC1 Ink Name		00H	(*1)
A1H	CSIC2 Ink Name		00H	(*1)
A2H	CSIC3 Ink Name		00H	(*1)
A3H	CSIC4 Ink Name		00H	(*1)
A4H	CSIC5 Ink Name		00H	(*1)
A5H	CSIC6 Ink Name		00H	(*1)
A6H	CSIC7 Ink Name		00H	(*1)
A7H	CSIC Printer ID	98H:R4C6220 world version	00H	98H
A8H ABH	Reserved		- -	- -
ACH	CR Measurement Adjustment		00H	(*1)

Table 7-16. EEPROM Address Map

Address	Explanation	Setting	QPIT setting	Factory settings
ADH B8H	Reserved		- -	- -
B9H	PF Measurement 1(ES3) Data		00H	(*1)
BAH	PF Measurement 2(ES5) Data		00H	(*1)
BBH	PW White Level		00H	00H
BCH BDH	CR Total integral Average	Lower byte Upper byte	00H 00H	(*1) (*1)
BEH BFH	Reserved		- -	- -
C0H C1H	Password		5AH 0FH	- -
C2H D3H	USB ID	1 st character code Last character code	00H 00H	(*1) (*1)
D4H D8H	1394 ID	1 st character code Last character code	00H 00H	(*1) (*1)
D9H	Head Hot Error Disable		00H	00H
DAH	Panel mask function	bit0: Mask Load/Eject bit1: Mask Ink bit2: Mask Roll bit3-bit7: Reserved	00H	00H
DBH	Reserved		-	-
DCH DFH	Custom EEPROM sub number	Least byte ↓ Most byte	00H 00H	00H 00H
E0H	Market ID	00:World	00H	00H
E1H	Reserved		-	-

Table 7-16. EEPROM Address Map

Address	Explanation	Setting	QPIT setting	Factory settings
E2H	Model Name	1 st character code	00H	-
FFH		Last character code	00H	-

*1. Adjusted at factory.

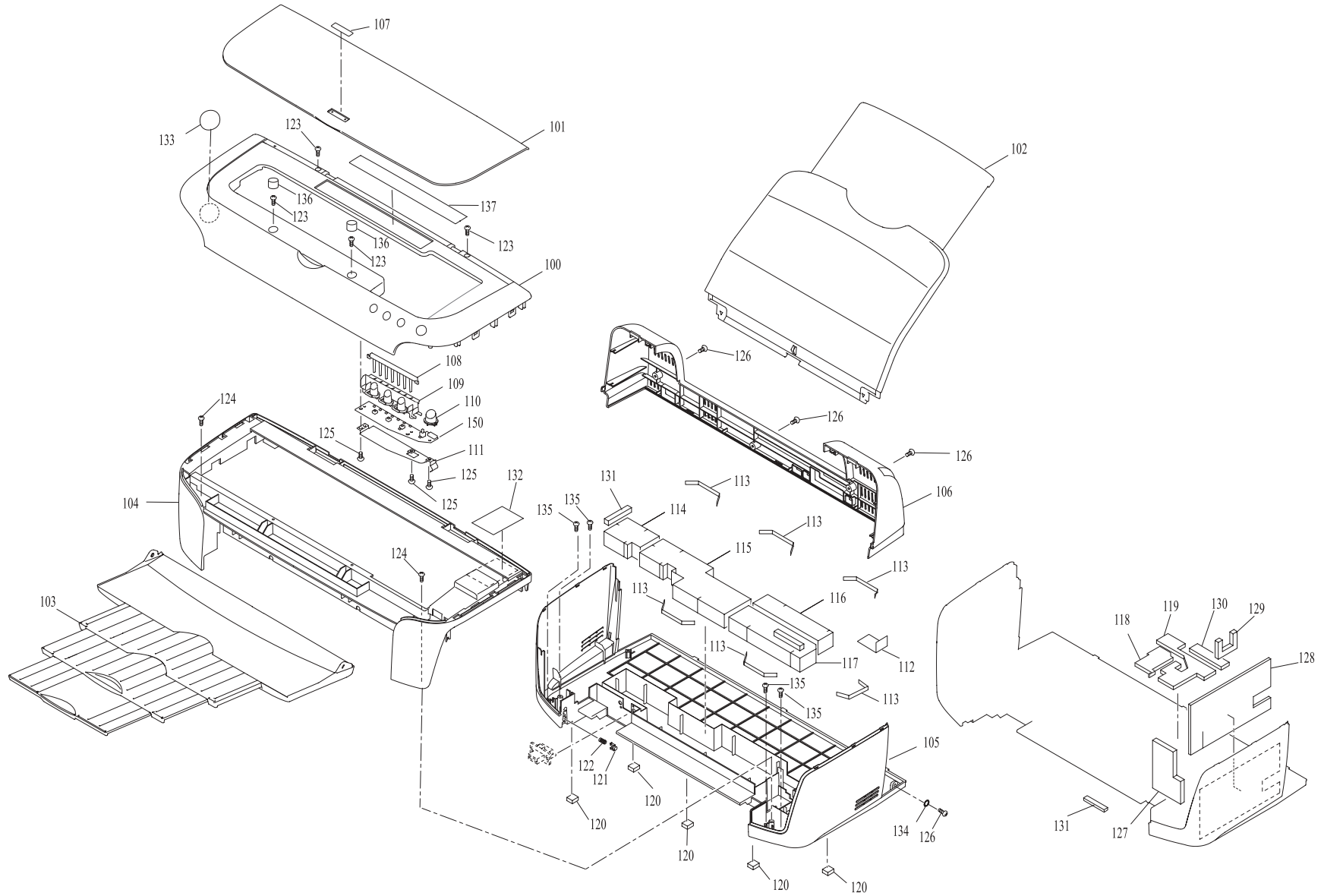
*2. Initialized after performed panel initialization of EEPROM.

*3. Initialized after performed panel initialization of the ink overflow counter in EEPROM.

7.2 Exploded Diagram

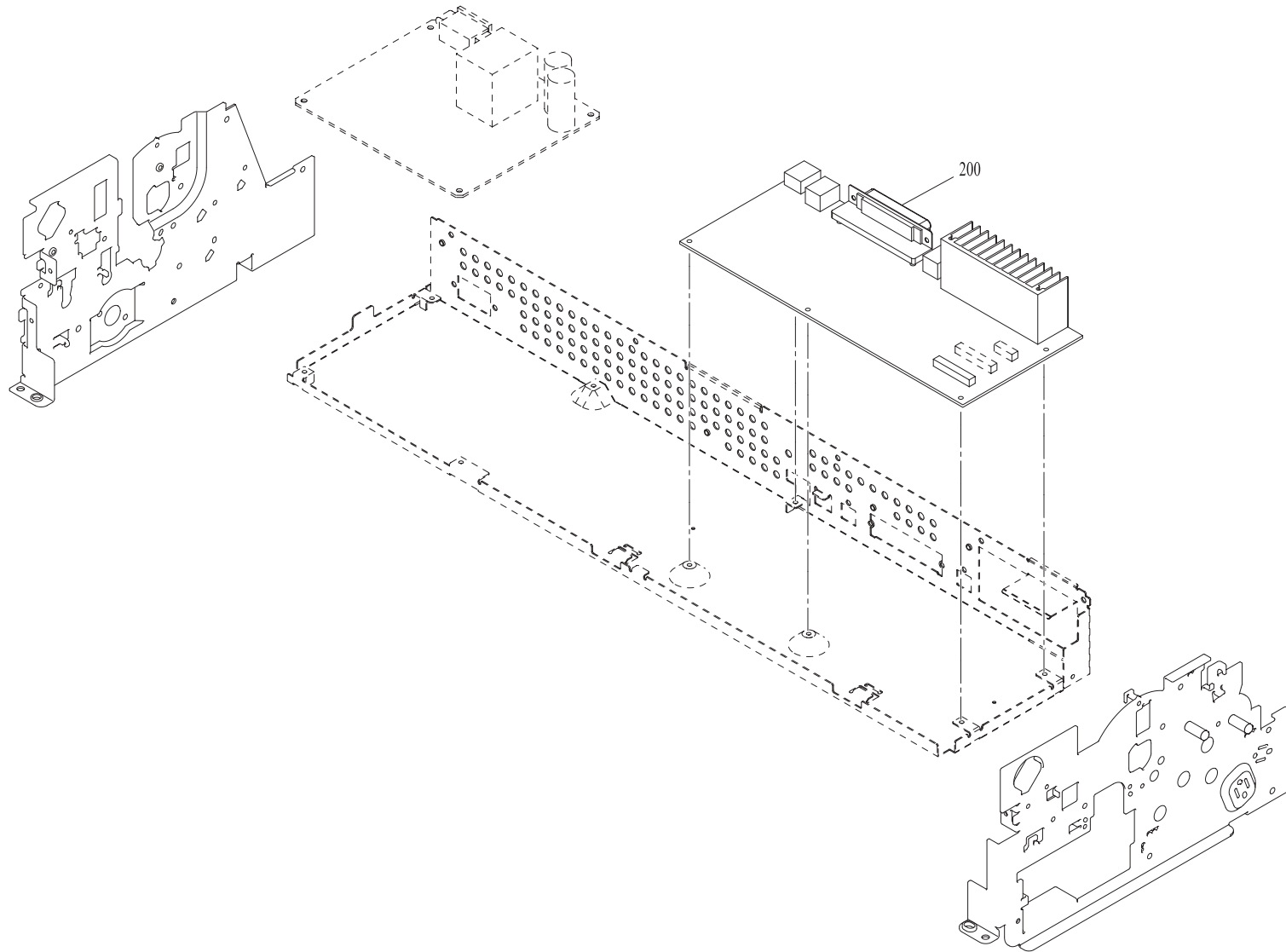
Following pages show exploded diagram.

- Stylus PHOTO 2100/2200 No.01
- Stylus PHOTO 2100/2200 No.02
- Stylus PHOTO 2100/2200 No.03
- Stylus PHOTO 2100/2200 No.04
- Stylus PHOTO 2100/2200 No.05
- Stylus PHOTO 2100/2200 No.06
- Stylus PHOTO 2100/2200 No.07
- Stylus PHOTO 2100/2200 No.08
- Stylus PHOTO 2100/2200 No.09
- Stylus PHOTO 2100/2200 No.010
- Stylus PHOTO 2100/2200 No.011



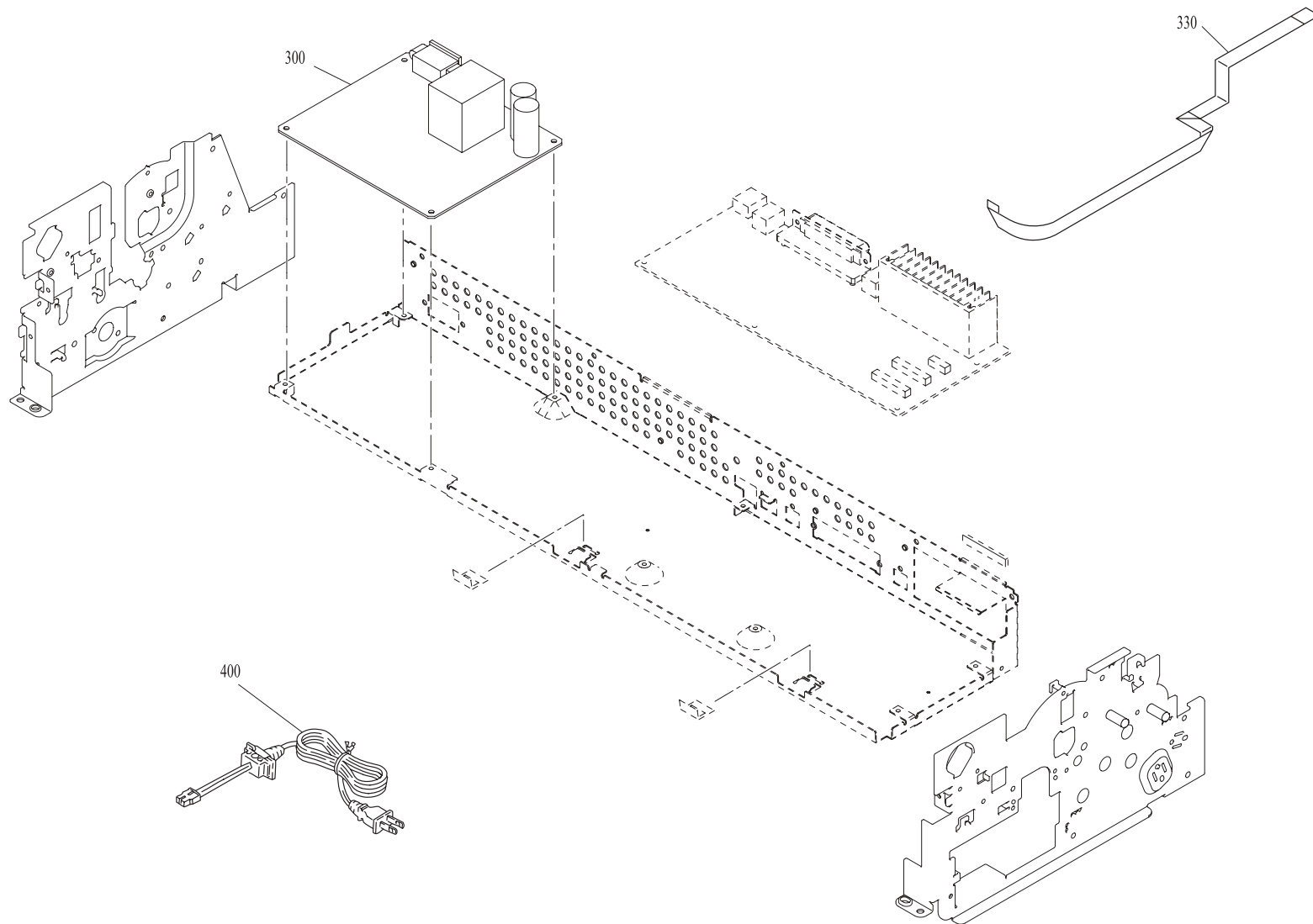
EPSON STYLUS PHOTO 2100/2200 No.1 Rev.01 C387-CASE-011

Figure 7-2. Stylus PHOTO 2100/2200 Exploded Diagram 1



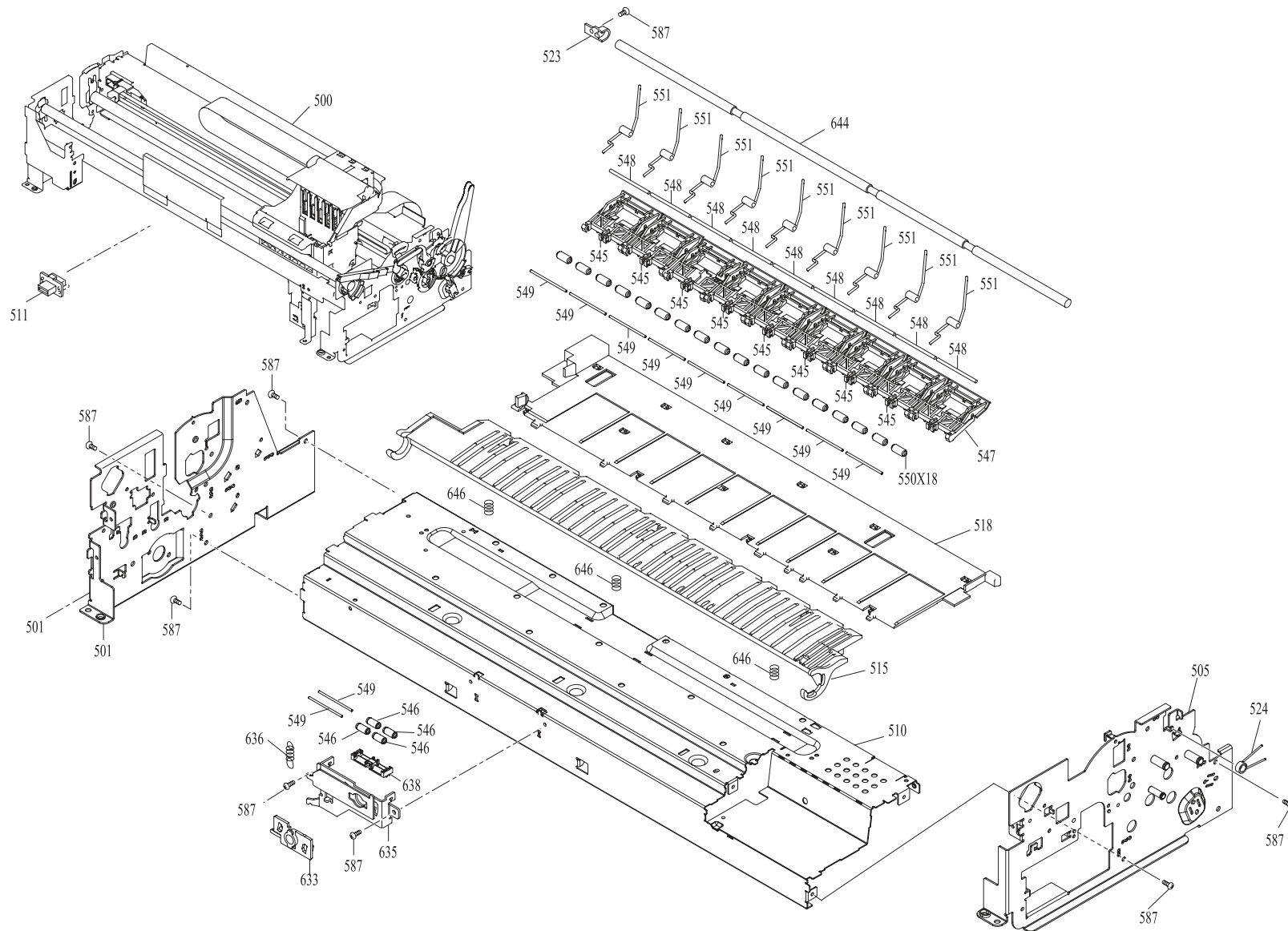
EPSON STYLUS PHOTO 2100/2200 No.2 Rev.01 C387-ELEC-011

Figure 7-3. Stylus PHOTO 2100/2200 Exploded Diagram 2



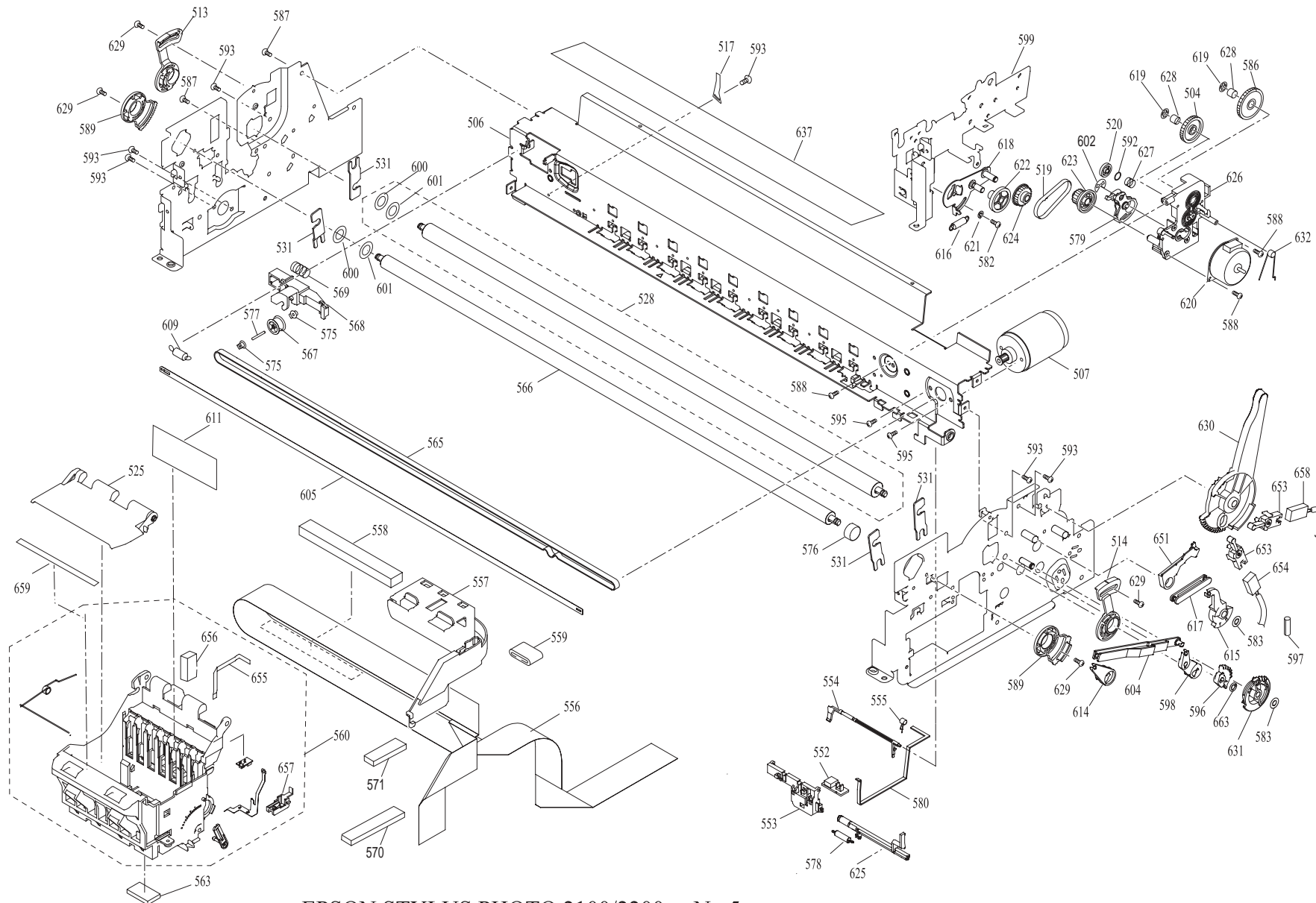
EPSON STYLUS PHOTO 2100/2200 No.3 Rev.01 C387-POWE-011

Figure 7-4. Stylus PHOTO 2100/2200 Exploded Diagram 3



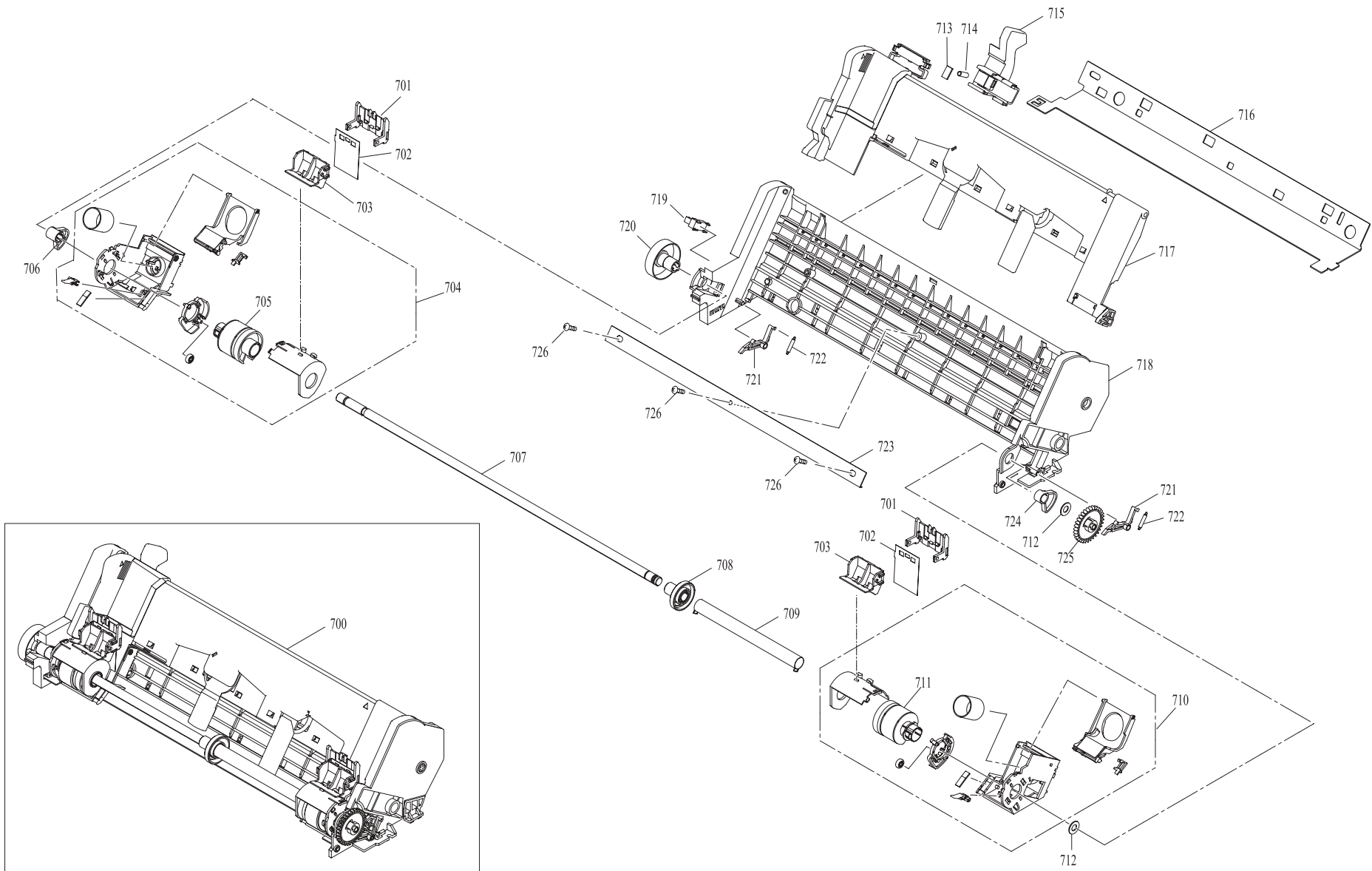
EPSON STYLUS PHOTO 2100/2200 No.4 Rev.01 C387-MECH-011

Figure 7-5. Stylus PHOTO 2100/2200 Exploded Diagram 4



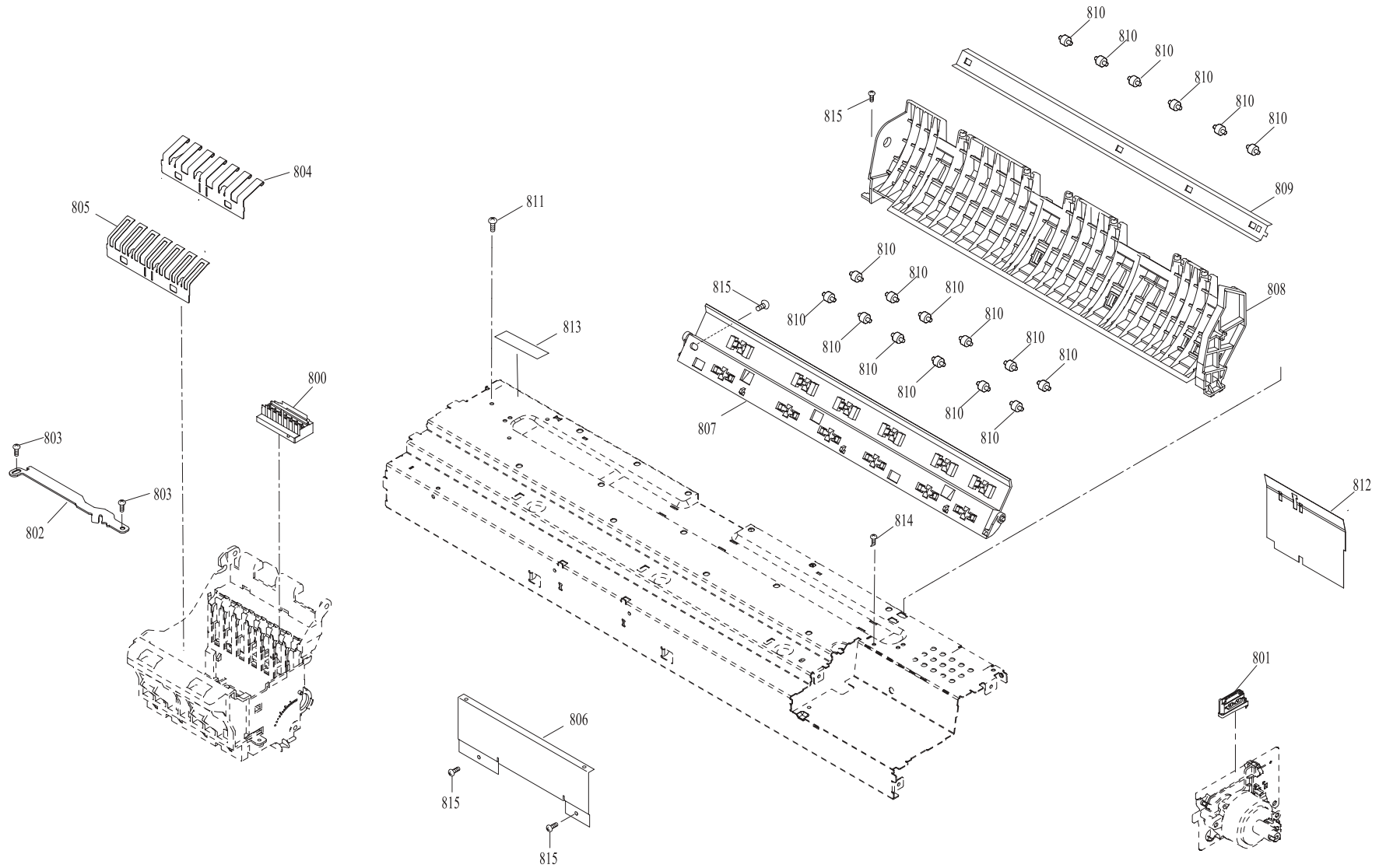
EPSON STYLUS PHOTO 2100/2200 No.5 Rev.01 C387-MECH-021

Figure 7-6. Stylus PHOTO 2100/2200 Exploded Diagram 5



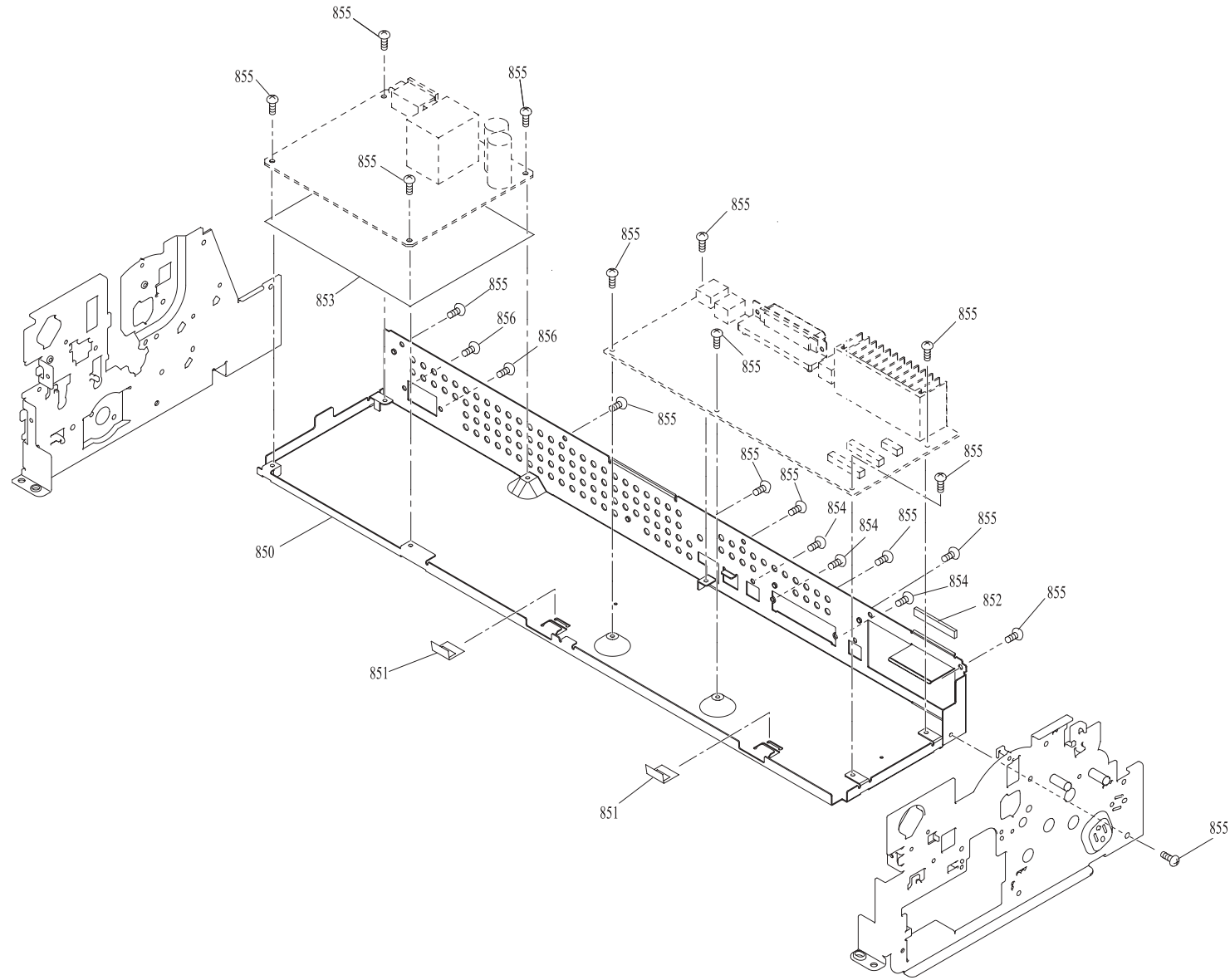
EPSON STYLUS PHOTO 2100/2200 No.7 Rev.01 C387-MECH-041

Figure 7-8. Stylus PHOTO 2100/2200 Exploded Diagram 7



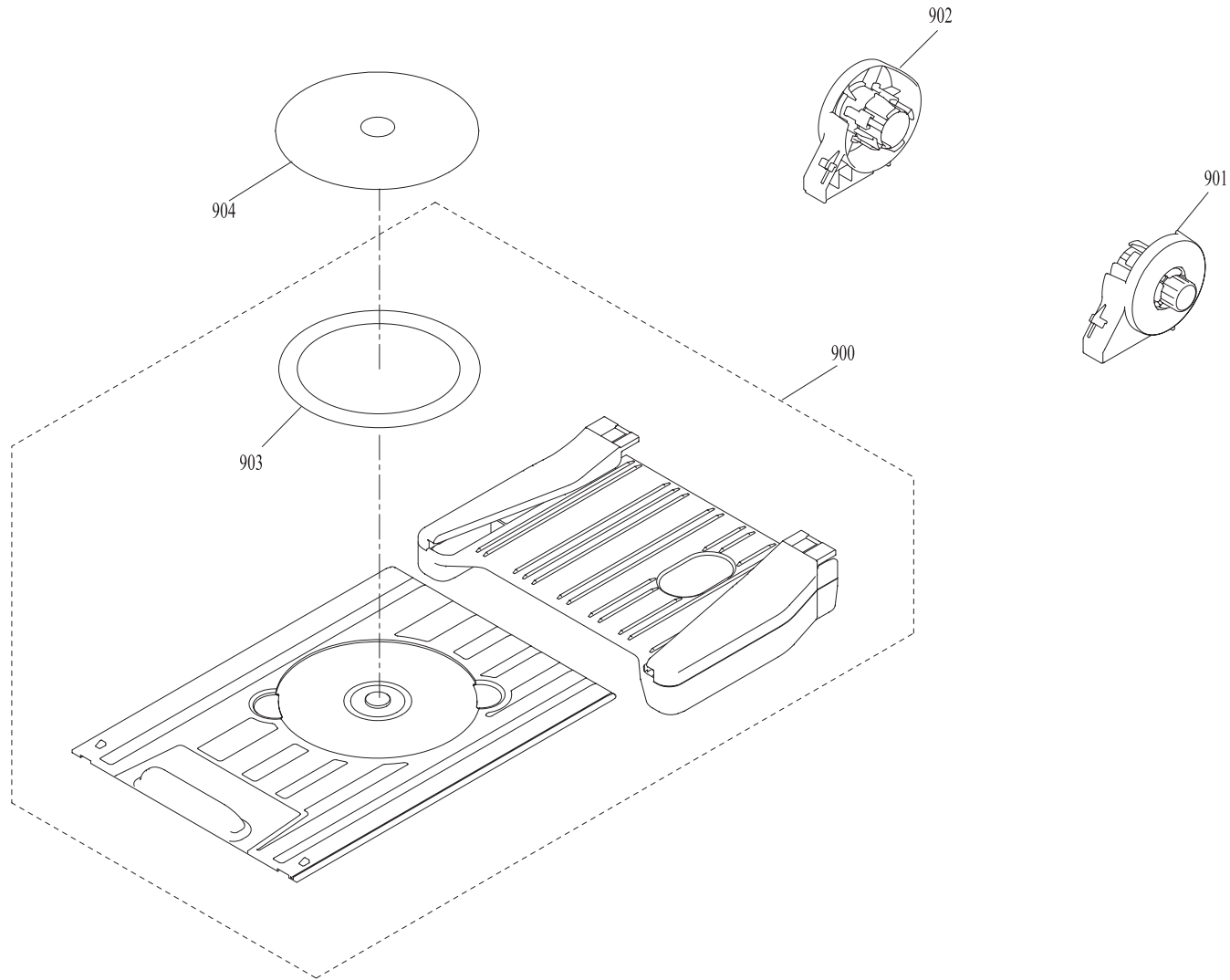
EPSON STYLUS PHOTO 2100/2200 No.8 Rev.01 C387-MECH-051

Figure 7-9. Stylus PHOTO 2100/2200 Exploded Diagram 8



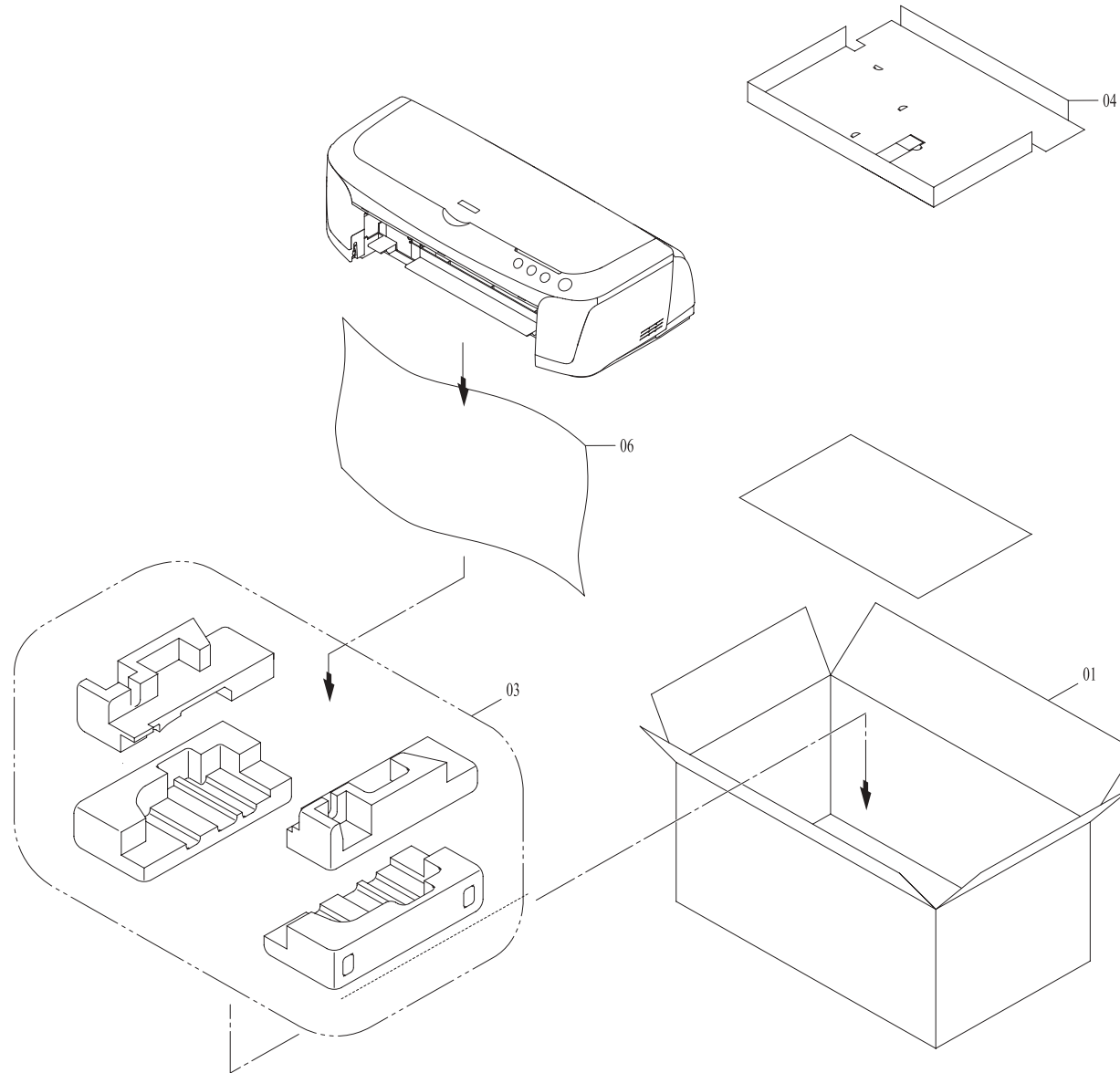
EPSON STYLUS PHOTO 2100/2200 No.9 Rev.01 C387-MECH-061

Figure 7-10. Stylus PHOTO 2100/2200 Exploded Diagram 9



EPSON STYLUS PHOTO 2100/2200 No.10 Rev.01 C387-MECH-071

Figure 7-11. Stylus PHOTO 2100/2200 Exploded Diagram 10



EPSON STYLUS PHOTO 2100/2200 No.11 Rev.01 C387-PACK-011

Figure 7-12. Stylus PHOTO 2100/2200 Exploded Diagram 11

7.3 Parts List for EPSON Stylus Photo 2100

Table 7-17. Parts List for EPSON Stylus Photo 2100

No	Parts Code	Parts Name		
'100'	1196501	HOUSING	UPPER;ENM2-F	
'101'	1104087	COVER	PRINTER;By	
'102'	1104158	PAPER SUPPORT	ASSY.;B	
'103'	1104157	STACKER	ASSY.;B	
'104'	1104084	HOUSING	MIDDLE;EBCK	
'105'	1104085	HOUSING	LOWER;EBCK	
'106'	1113994	HOUSING	REAR	EBCK;B
'107'	1113892	LOGO PLATE 10X40;F		TANSYOKUSEIKEI
'108'	1090240	OPTICAL PLATE		
'109'	1104159	BUTTON	ASSY.;B	
'110'	1104160	BUTTON	PS	ASSY.;B
'111'	1090244	GROUNDING	PANEL	
'112'	1091355	SHEET	STOPPER	POROUS PAD
'113'	1091372	SHEET STOPPER	POROUS PAD	UPPER
'114'	1109054	POROUS PAD	INK EJECT	LEFT
'115'	1109053	POROUS PAD	INK EJECT	MIDDLE
'116'	1109052	POROUS PAD	INK EJECT	REAR RIGHT
'117'	1109051	POROUS PAD	INK EJECT	FRONT RIGHT
'118'	1091701	POROUS PAD	PUMP	LEFT
'119'	1090413	POROUS PAD	WASTE FLUID	S
'120'	1108107	FOOT		
'121'	1040649	LOCK	STACKER	
'122'	1043083	COMPRESSION SPRING	5.1	
'123'	1002674	C.B.S-TITE SCREW	M3X12	
'124'	1044397	C.B.P SCREW	3*14	F/ZN
'125'	1012350	C.B.P-TITE	3X10	F/ZN
'126'	1073172	C.B.S. SCREW(B300204411)	M3X10	
'127'	1111793	POROUS PAD	INK	STOPPER

Table 7-17. Parts List for EPSON Stylus Photo 2100

No	Parts Code	Parts Name		
'128'	1111794	POROUS PAD	INK	STOPPER
'129'	1111796	POROUS PAD	INK	STOPPER
'130'	1112508	POROUS PAD	INK EJECT	SMALL
'131'	1112492	POROUS PAD	INK	STOPPER
'132'	1112556	SHEET	HOUSING	MIDDLE
'134'	1074071	PLAIN WASHER(B100150512)	M3X0.5X8	
'135'	1024145	C.B.P.SCREW	4X12	F/ZN
'136'	1108106	CAP	HOUSING	UPPER
'137'	1104987	LABEL	CAUTION;B	
'138'	2055615	CONNECTER	MAIN	
'139'	1090758	LABEL	PIM LOGO	
'150'	2060146	BOARD ASSY.	PANEL	5849A,STANDARD
'200'	2060140	BOARD ASSY.	MAIN	5846A,STANDARD
'IC5'	2073203	OTP-ROM	THO00	OTHER,8 MBIT,42
'500'	2071646	PRINTER MECHANISM(ASP)	MA810-101	
'501'	1091608	FRAME	ASSY	LEFT
'502'	2060541	MOTOR ASSY.	PF	3.15W,
'503'	1061310	GROUNDING PLATE	PAPER GUIDE	FRONT
'504'	1048835	COMBINATION GEAR	12	22.4
'505'	1091609	FRAME	ASSY	RIGHT
'506'	1090312	FRAME	UPPER	
'507'	2060540	MOTOTR ASSY.	CR	3.15W,
'508'	1091841	PUMP ASSY		
'509'	1091840	CAP ASSY		
'510'	1090317	FRAME	UNDER	
'512'	1090316	FRAME	FRONT	
'513'	1114113	BUSHING	PARALLEL ADJUST	LEFT;B
'514'	1114112	BUSHING	PARALLEL ADJUST	RIGHT;B
'515'	1090374	PAPER GUIDE	REAR	
'516'	1104361	ROLLER	PF	MAIN

Table 7-17. Parts List for EPSON Stylus Photo 2100

No	Parts Code	Parts Name		
'517'	1103743	STOPPER	HOLDER	PUREY
'518'	1104240	PAPER GUIDE	MANUAL;B	
'519'	1090723	BELT	PUMP	
'520'	1048834	SPUR GEAR	15.2"	
'521'	1092108	MINI CLAMP	UMAS-02WL-0	
'522'	1082253	REUSE LOCK MINI CLAMP		RLMC-01T V0
'523'	1083953	HOLDER	SHAFT	LEVER
'524'	1061006	TORSION SPRING	177.4	
'525'	1083862	COVER	INK	
'526'	1104815	CAM	RELEASE	WHEEL
'527'	1104816	TORSION SPRING	4.80	
'528'	1090333	SHAFT	CR	GUIDE;A
'529'	1104362	ROLLER	PAPER EJECT	MAIN
'530'	1083963	COMBINATION GEAR	17	24.5
'531'	1090336	MOUNTING PLATE	SHAFT	LEFT
'532'	1083961	SPUR GEAR	43	
'533'	1060890	BUSH	12	RIGHT
'534'	1030971	PLANE WASHER	4.1X0.5X6.5	
'535'	1091802	PAPER GUIDE	ASSY	FRONT
'536'	1042582	GROUNDING WIRE	EJ	
'537'	1061843	GROUNDING SPRING	PF	
'538'	1090351	FRAME	EJECT	
'539'	1104364	HOLDER	STAR WHEEL	RIGHT
'540'	1104365	HOLDER	STAR WHEEL	MIDDLE
'541'	1104366	HOLDER	STAR WHEEL	LEFT
'542'	1113215	SHEET	STOPPER	PUMP
'543'	1083962	SUPER GEAR	62	
'544'	1104363	ROLLER	PAPER EJECT;B	MAIN
'545'	1083956	PAPER GUIDE	UPPER	
'546'	1058678	ROLLER	DRIVEN;B	

Table 7-17. Parts List for EPSON Stylus Photo 2100

No	Parts Code	Parts Name		
'547'	1083957	PAPER GUIDE	RIGHT	
'548'	1030968	SHAFT	PAPER GUIDE	UPPER
'549'	1030969	SHAFT	ROLLER	DRIVEN
'550'	1038961	ROLLER	DRIVEN;D	
'551'	1111958	TORSION SPRING	1.127	
'552'	2022329	CIRCUIT ASSY	PE	
'553'	1083958	HOLDER	PE	
'554'	1090345	LEVER	PE	
'555'	1090347	TORSION SPRING	0.19	
'556'	2060172	CABLE	HEAD	
'557'	1090326	HOLDER	CABLE	HEAD
'558'	1108946	SPACER	CABLE HEAD	
'559'	2069712	FERRITE CORE		
'560'	1104360	CARRIAGE	MAIN	ASSY
'561'	1090364	PAPER GUIDE	EJECT	LOWER
'562'	1090718	CLAMP	HARNESS	
'563'	1049380	OIL PAD		
'564'	1104243	GUIDE	ATTACHMENT	CDR;B
'565'	1090332	TIMING BELT		
'566'	1090334	SHAFT	CR	GUIDE;B
'567'	1069198	PULLEY	DRIVEN	
'568'	1090337	HOLDER	PUREY	DRIVEN
'569'	1104394	COMPRESSION SPRING	24.5	
'570'	1090188	POROUS PAD	CABLE HEAD	
'571'	1108945	POROUS PAD	CABLE HEAD;B	
'572'	1074107	RETAINING RING(B150300711)	TYPE-E(4)	TYPE-E(4)F/UC,ETWJ-4
'573'	1091178	LEAF SPRING	LEVER	CLEANER
'575'	1050346	BUSHING	PULLEY	DRIVEN
'576'	1058063	BUSH	PG CHANGE	RIGHT

Table 7-17. Parts List for EPSON Stylus Photo 2100

No	Parts Code	Parts Name		
'577'	1050347	SHAFT	PULLEY	DRIVEN
'578'	1048907	EXTENSION SPRING	0.618	
'579'	1048833	LEVER	PLANET	
'580'	2060176	HARNESS	PE	
'582'	1048721	SHAFT	SPUR GEAR	PLANET
'583'	1030971	PLANE WASHER	4.1X0.5X6.5	
'586'	1090377	COMBINATION GEAR	14.28	
'587'	1073165	C.B.S. SCREW(B300204211)	M3X6	
'588'	1005019	C.B.P-TITE SCREW	3X8	F/ZN
'589'	1090335	BUSHING PARALLE ADJUST	SUB	LEFT
'591'	1043627	C.B.P-TITE	2.5X5	F/ZN
'592'	1048909	PLAIN WASHER	6.2*0.2*9	L/NA
'593'	1073165	C.B.S. SCREW(B300204211)	M3X6	
'594'	1073165	C.B.S. SCREW(B300204211)	M3X6	
'595'	1004539	C.P.SCREW(B010103311)	M3X6	
'596'	1083952	LEVER	CONNECT	RELESE
'597'	1058469	PARALLEL PIN B	2X10	
'598'	1083944	LEVER	PG	CHANGE
'599'	1090315	FRAME	MIDDLE\	
'600'	1044149	PLANE WASHER	6.1X0.2X17	S/NA
'601'	1076283	LEAF SPRING(B101253390)	8.2X0.15X15	
'602'	1074104	RETAINING RING(B150300611)	TYPE-E(3)	
'603'	1048913	TAPE	D50	
'604'	1083950	LINK	PG CHANGE	
'605'	2032470	SCALE	CR	
'606'	1055706	SCALE	PF	
'608'	2060148	FFC	ENCORDER	
'609'	1048888	EXTENSION SPRING	1.494	
'610'	1035673	MINI CRAMP UAMS-05SN-W		

Table 7-17. Parts List for EPSON Stylus Photo 2100

No	Parts Code	Parts Name		
'611'	1104114	COVER	ENCODER	
'613'	1055136	MOUTING PLATE	BOARD ASSY	
'614'	1083945	BUSHING	PG	CHANGE
'615'	1083949	LEVER	SPRING	PG CHANGE
'616'	1090368	EXTENTION SPRING	9.27	
'617'	1058085	LINK	SPRING	PG CHANGE
'618'	1091607	LEVER	ASSY	COMBINATION GEAR
'619'	1050767	SET RING	D8.8	
'620'	2060542	MOTOR ASSY.	ASF	33.6W,
'621'	1076263	P.W.	3.1X0.5X12	F/ZN(B100165911)
'622'	1090369	SPUR GEAR	26.4	
'623'	1048839	COMBINATION GEAR	17.19	25.6
'624'	1048840	COMBINATION GEAR	12	22.92
'625'	1083955	LEVER	DE	LOCK
'626'	1090376	MOUNTING PLATE	MOTOR	ASF
'627'	1048906	COMPRESSION SPRIN	3.944	
'628'	1050765	FERUTO	D3.6	
'629'	1032300	C.B.S-TITE(P4)	3X6	F/ZN
'630'	1104244	LEVER	DRIVEN	RELEASE;B
'631'	1083948	INTERMITTENT GEAR	24	30
'632'	1090366	TORSION SPRING	7.13	
'633'	1049392	BUSHU	ROLLER PF	SUPPORT
'634'	1090365	FRAME	CATTER	SUPPORT
'635'	1049394	MOUNTIN PLATE	LEVER	ROLLER PF
'636'	1049395	EXTENSION SPRING	10.1	
'636'	1108947	GROUNDING SPRING	CUTTER;B	
'637'	1104100	SHEET	PROTECTOR	INK
'638'	1051412	HOLDER	ROLLER PF	SUPPORT
'639'	1083966	HOLDER	SET	LEFT

Table 7-17. Parts List for EPSON Stylus Photo 2100

No	Parts Code	Parts Name		
'640'	1083965	HOLDER	SET	RIGHT
'641'	1090343	PORUS PAD	PAPER GUIDE	FRONT
'644'	1090339	SAHFT	LEVER	RELEASE
'646'	1112124	COMPRESSION SPRING	0.44	
'648'	2060178	DETECTOR	CDR	
'649'	2060179	HARNESS	DETECTOR	CDR
'650'	1091644	EXTENTION SPRING	1.554	
'651'	1083954	LEVER	CLICK	
'653'	2020393	DETECTOR	LEAF	B2
'654'	2060175	HARNESS	DETECTOR	RELEASE
'655'	2060186	HARNESS	DETECTOR	PW
'656'	1083861	HOLDER	DETECTOR	PW
'657'	2036378	BOARD ASSY.	DETECTOR	PH
'658'	2060173	HARNESS	DETECTOR	PG
'659'	1108937	LABEL	POSITION	CARTRIDGE;B
'662'	2055067	BOARD ASSY.	ENCODER	
'663'	1040481	CUT PLANE WASHER	4.2X0.3X8	L/NA
'700'	1109282	ASF UNIT;B		
'701'	1104251	COVER	SHEET	PAPER CONTROL;B
'702'	1040599	SHEET	PAPERFED	
'703'	1104252	HOLDER	PAPER CONTROL;B	
'704'	1104884	ROLLER	LD	LEFT
'705'	1104368	ROLLER	MAIN	ASSY.
'706'	1083974	LEVER	HOPPER	RELEASE
'707'	1090378	SHAFT	ROLLER	LD
'708'	1104253	ROLLER	SUB	LD
'709'	1090383	COMPRESSION SPRING	0.3	
'710'	1104882	ROLLER	LD	RIGHT
'711'	1104367	ROLLER	MAIN	ASSY.

Table 7-17. Parts List for EPSON Stylus Photo 2100

No	Parts Code	Parts Name		
'712'	1074768	RETAINING RING(B150300911)	TYPE-E(6)	
'713'	1053757	PAD	BRAKE	EDGE GUIDED
'714'	1090387	COMPRESSION SPRING	2.26	
'715'	1104237	EDGE GUIDE	ROLL;B	
'716'	1090370	FRAME	ASF	LOWER
'717'	1109283	HOPPER	MAIN	ASSY.;B
'718'	1104247	FRAME	ASF;B	
'719'	2032842	DETECTOR	HP;E	4V,50MA,100MW
'720'	1083976	WHEEL	DETECTOR	
'721'	1083972	LEVER	SET	EDGE GUIDE
'722'	1030959	EXTENSION SPRING	0.088	
'723'	1036863	STRENGTHEN PLATE	FRAME	ASF
'724'	1083973	LEVER	HOPPER	RELEASE
'725'	1083975	SPUR GEAR	32	
'726'	1024130	C.B.P-TITE SCREW	3X6	F/ZN
'727'	1104254	PAPER	GUIDE	REAR
'728'	1104255	"IDLE ROLLER;B""""		
'729'	2060182	HARNESS	ASF	
'730'	1073165	C.B.S. SCREW(B300204211)	M3X6	
'800'	F138010	PRINT HEAD	672	I8010-1
'801'	1104293	CLEANER	HEAD;C	
'802'	1090325	FASTENER	HEAD	
'803'	1024130	C.B.P-TITE SCREW	3X6	F/ZN
'804'	1090329	LEEF SPRING	SET	CARTRIDGE;A
'805'	1090330	LEEF SPRING	SET	CARTRIDGE;B
'806'	1090243	MOUNTING PLATE	HAUSING	UPPER
'808'	1104239	PAPER GUIDE	ROLL;B	
'809'	1090390	RAINFORCE PLATE	PAPER GUIDE	ROOL
'810'	1055837	IDLE ROLLER		

Table 7-17. Parts List for EPSON Stylus Photo 2100

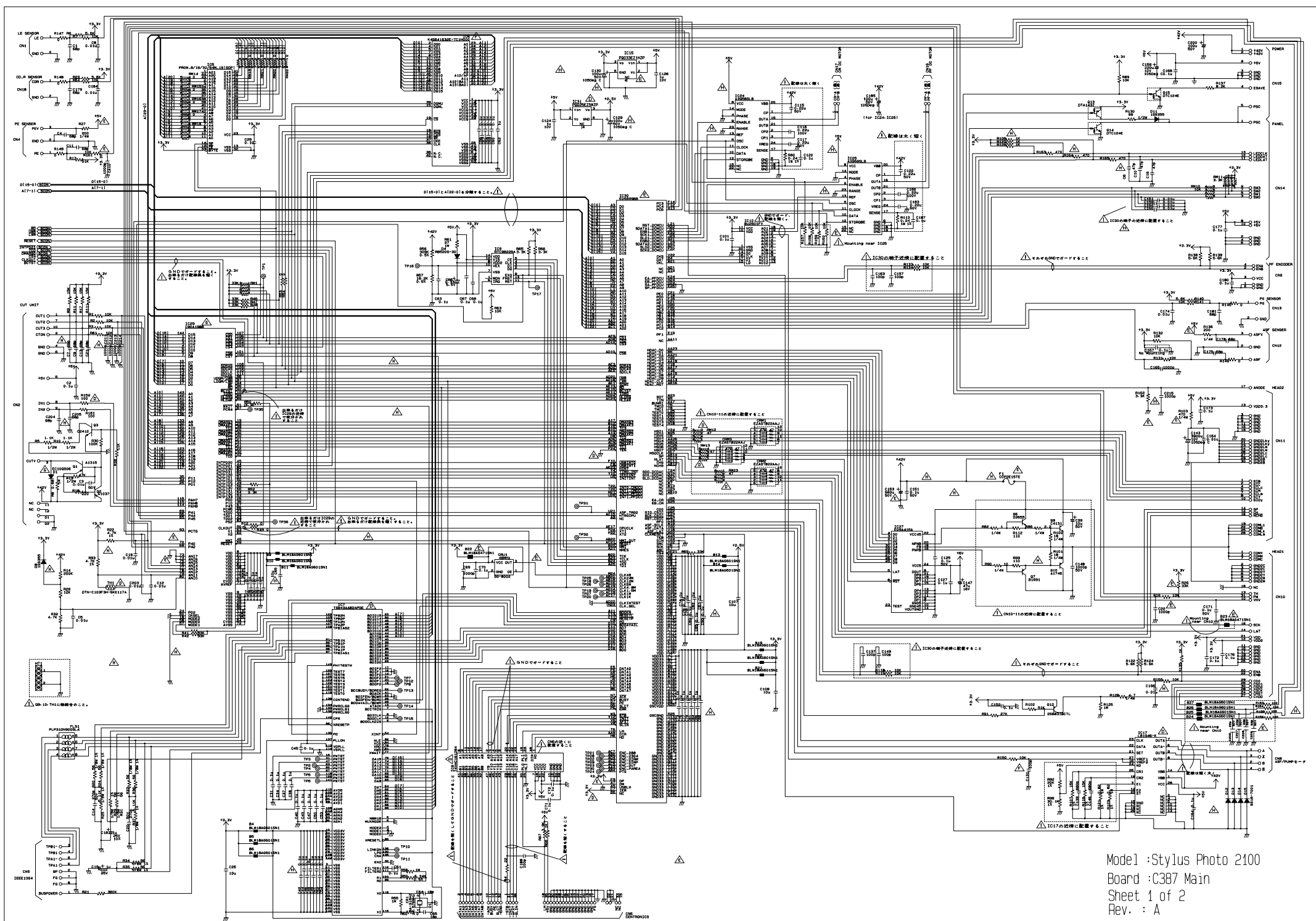
No	Parts Code	Parts Name		
'811'	1005416	SHAFT	MOUNT	CR
'812'	1090722	SHEET	PE	
'813'	1112436	LABEL;QR		
'814'	1032300	C.B.S-TITE(P4)	3X6	F/ZN
'815'	1073165	C.B.S. SCREW(B300204211)	M3X6	
'816'	1091643	COMPRESSION SPRING	2.45	
'817'	1090411	CLEANER	HEAD;B	
'850'	1090242	SHIELD PLATE	M/B	
'851'	1030669	GROUNDING PLATE		
'852'	1109127	GASKET	MAIN	
'853'	1104431	SHEET	SHIELD	
'854'	1004539	C.P.SCREW(B010103311)	M3X6	
'855'	1073165	C.B.S. SCREW(B300204211)	M3X6	
'856'	1024130	C.B.P-TITE SCREW	3X6	F/ZN
'857'	1075905	LOCKING WIRE SADDLE(X510080050)		
'858'	1109126	FERRITE CORE	MAIN	
'900'	1109302	TRAY	CDR	UNIT;B
'901'	1109352	FRAME	ROLL PAPER	RIGHT;D
'902'	1109353	FRAME	ROLL PAPER	LEFT;D
'903'	1091418	ADAPTER	CDR	
'904'	1061518	SHEET	CD	DUMMY
'905'	1109048	AUTOMATIC ROLL PAPER CUTTER	MAIN	
'01'	5022318	INDIVIDUAL CARTON BOX FOR EUROPE		
'03'	5020227	PAD SET	PRINTER	
'04'	5020232	PAD	ACCESSORY	
'05'	5021532	PAD	STACKER	
'06'	5021535	PLASTIC PROTECTIVE SHEET1150X1100X0.04		
'07'	5021533	PADPAPER	STACKER	

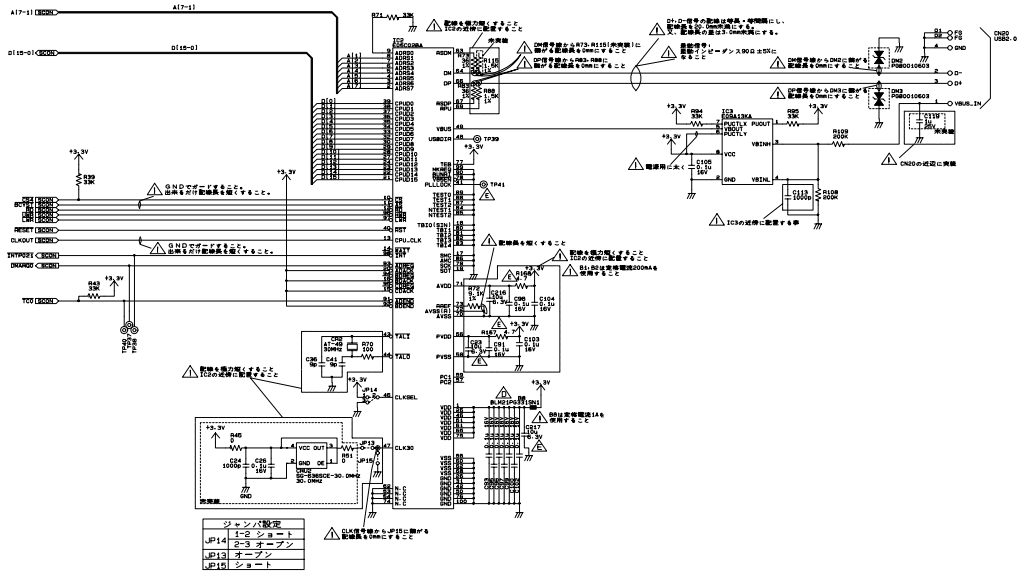
Table 7-17. Parts List for EPSON Stylus Photo 2100

No	Parts Code	Parts Name		
'08'	5021534	PADPAPER	STACKER;B	
'09'	5022322	PAD	SLEEVE;B	
'10'	5012467	PLASTIC PROTECTIVE BAG(X680052010)	370X250X0.03T	
'11'	5022320	PAD	ACCESSORY;B	
'12'	5022321	PAD	ACCESSORY;C	
'13'	5020266	PAPER	COVER CARTRIDGE	
	1055984	SPECIAL COATED PAPER	9	OVERSEAS
	1092301	INK CARTRIDGE	PHOTO B	OVERSEAS
	1092303	INK CARTRIDGE	C	OVERSEAS
	1092304	INK CARTRIDGE	M	OVERSEAS
	1092305	INK CARTRIDGE	Y	OVERSEAS
	1092306	INK CARTRIDGE	LC	OVERSEAS
	1092307	INK CARTRIDGE	LM	OVERSEAS
	1092308	INK CARTRIDGE	LIGHT B	OVERSEAS
	1092309	INK CARTRIDGE	MATTE B	OVERSEAS
	1156225	MEDIA PORTFOLIO	3	EU&ASIA
	3010464	SOFTWARE CD-ROM	EFGD	
	3010466	SOFTWARE CD-ROM	EIPS	
	4013149	WARRANTY CARD;EURO B		
	4014136	WARNING SHEET		
	4022177	GRAY BALANCER CHARTSET	BALANCER;×fæ0f	
	2060144	BOARD ASSY.	POWER SUPPLY	5848A,STANDARD &KOREA
	2060157	HARNESS		
	2068898	POWER CABLE		VD21202SN-S2B5
	1056368	CLEANING ASSY.#F753	PHOTO2000/MC2000	
	1113311	PG ADJUSTMENT GUAGE		

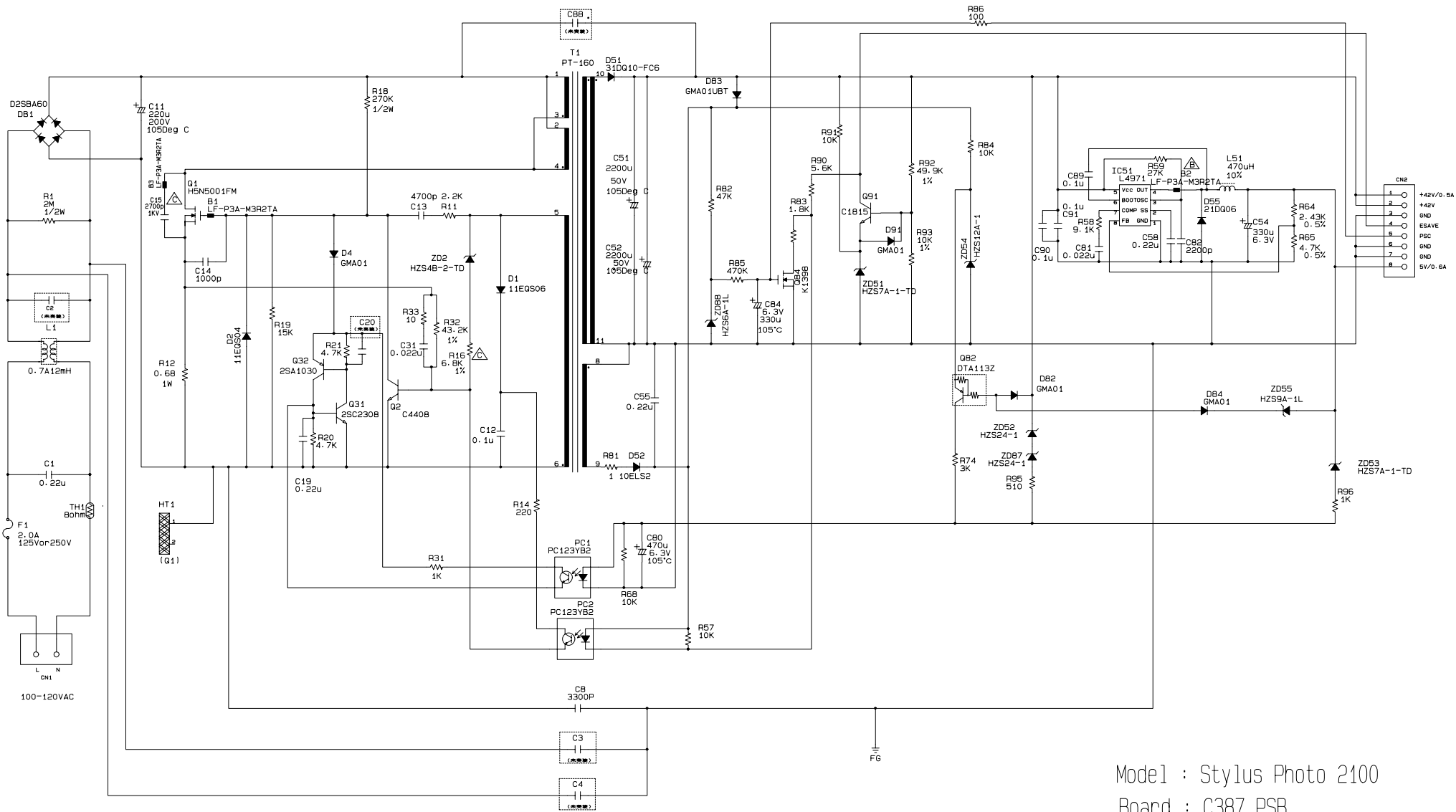
7.4 Circuit Diagram

- C387 MAIN Circuit diagram
- C387 MAIN Circuit diagram2
- C387 PSB Circuit diagram
- C387 PSE Circuit diagram
- C387 PNL Circuit diagram





ジャンパ設定	
JP14	1-2 ショート
JP19	2-3 オープン
JP15	1-2 ショート

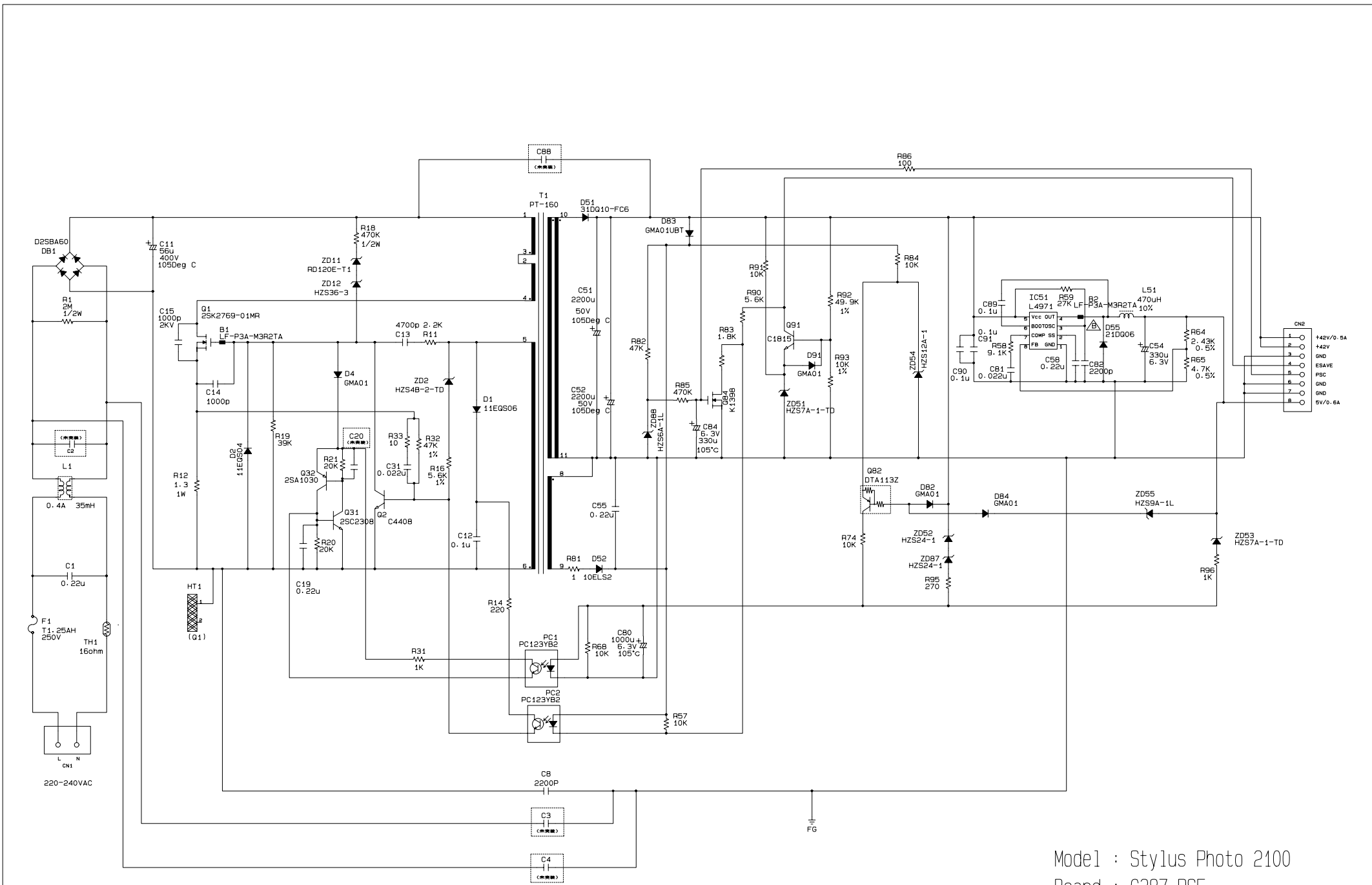


Model : Stylus Photo 2100

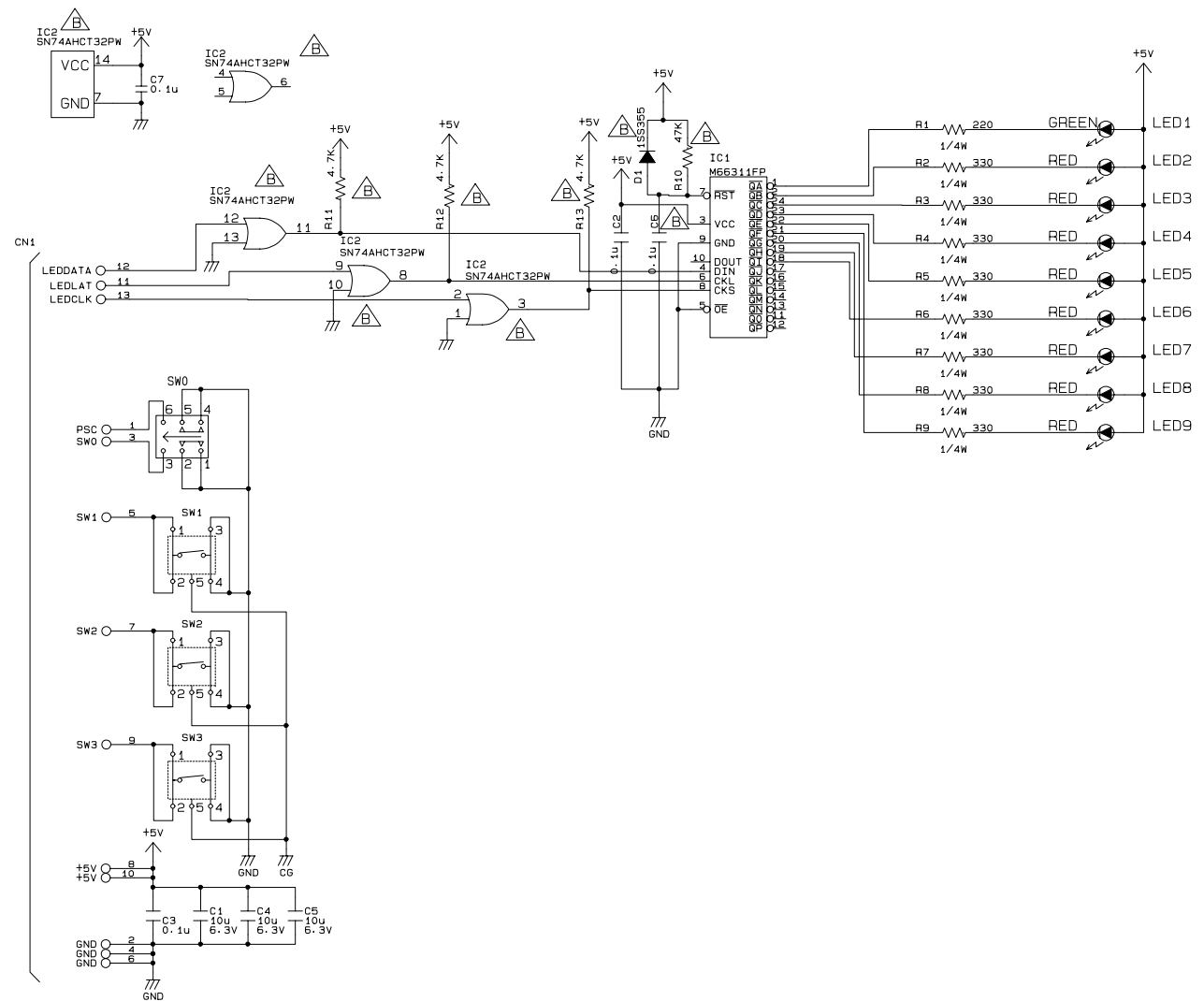
Board : C387 PSB

Sheets : 1 of 1

Rev. : A



Model : Stylus Photo 2100
 Board : C387 PSE
 Sheet : 1 of 1
 Rev. : A



Model : Stylus Photo 2100

Board : C387PNL

Sheet : 1 of 1

Rev. : A