



SEIKO WATCH CORPORATION
www.grand-seiko.com

BSJ9RCD-A2002
Printed in Japan



GS
Grand Seiko

Spring Drive
Operating Instructions

9RA5

Thank you very much for choosing a Grand Seiko watch.
For proper and safe use of your Grand Seiko watch, please
read the instructions carefully in this booklet before using it.

Keep this manual handy for easy reference.

Bracelet sizing is available at the retailer from whom the watch was purchased. If you cannot have your watch band sized by the retailer from whom the watch was purchased because you received the watch as a gift, or you moved to a distant place, please contact Grand Seiko international service network mentioned on CERTIFICATE OF GUARANTEE or our website. The service may also be available on a chargeable basis at other retailers, however, some retailers may not undertake the service.

If your watch has a protective film for preventing scratches, make sure to peel it off before using the watch. If the watch is used with the film on it, dirt, sweat, dust, or moisture may be attached to the film and may cause rust.

CONTENTS

■ INTRODUCTION - Spring drive watch -	2
• History of Spring Drive	3
• Spring Drive Mechanism	4
• Differences between the Spring Drive and mechanical watch	7
■ HANDLING CAUTIONS	8
■ CHECK THE CALIBER NUMBER AND WATER-RESISTANT LEVEL	9
■ CAUTIONS ON WATER RESISTANCE	10
■ NAMES OF THE PARTS	14
■ HOW TO USE	15
• Crown	15
• Power reserve indicator	16
• HOW TO USE	17
■ FUNCTIONS OF DIVER'S MODEL	19
• Unidirectional rotating bezel	19
• Slide adjuster	20
■ TO PRESERVE THE QUALITY OF YOUR WATCH	21
• After-sale service	21
• Guarantee	22
• Daily care	23
• Band	24
• Magnetic resistance (Magnetic influence)	25
• Lumibrite	26
• Troubleshooting	27
■ SPECIFICATIONS (Movement)	28

■ INTRODUCTION - Spring drive watch –

Thank you for purchasing the Grand Seiko Spring Drive watch.

The Spring Drive is Seiko's unique mechanism in which accuracy is controlled by a microelectronics quartz mechanism while using the power of the mainspring to move the hands.

The Spring Drive can be called a watch that strongly combines and connects the user with the latest advancements in technology.

A mechanical watch of taste and refinement with an accuracy equivalent to a quartz watch, this sophisticated and innovative watch ticks in step with the pace of a person's life.

This is a watch that creates a lifestyle for modern individuals who seek affluence and convenience in their life.

That is what the Grand Seiko Spring Drive watch is all about.

SEIKO WATCH CORPORATION

History of Spring Drive

Decades-long dream lives in the Grand Seiko

Grand Seiko's history symbolizes the culmination of efforts and development aiming for better practical watches.

The Grand Seiko watch was born in 1960, reached the very top in the mechanical watch field around the world at the end of the 1960's. After a hiatus of dozen years or so, in 1993, the Grand Seiko 9F series equipped with world-class quartz movement was released.

In 1998, the 9S series mechanical movement that combined traditional craftsmanship and advanced technology was developed to reintroduce the Grand Seiko mechanical caliber. Furthermore, while using the unwinding power of the mainspring as its sole power source, this Spring Drive realizes much greater accuracy than conventional mechanical watches. The watch also embodies the concepts of Grand Seiko that continues the challenge of creating the best practical watch.

- 1960 ● Released the first Grand Seiko.
- 1964 ● Participated in the Neuchatel Observatory Competition in Switzerland for the first time.
- 1968 ● Released Japan's first automatic winding 10-beat model, 61GS.
- 1968 ● Won the first prize in the mechanical wrist chronometer category of the Geneva Observatory Competition in Switzerland.
- 1978 ● Filed a patent for the Spring Drive mechanism for the first time.
- 1982 ● Filed a patent for the Spring Drive mechanism (registered). Started initial development.
- 1988 ● Released the first Grand Seiko quartz caliber.
- 1993 ● Started the second development of the Spring Drive.
● Released the Grand Seiko 9F series equipped with world-class quartz movement.
- 1997 ● Started the third development of the Spring Drive.
● Released technological announcement of the Spring Drive at the Swiss Society of Chronometry (SSC).
- 1998 ● Exhibited the Spring Drive at BASELWORLD.
● Released the Grand Seiko 9S series mechanical caliber combining traditional craftsmanship and advanced technology.
● Started the development of the automatic winding Spring Drive.
- 1999 ● Released the manual-winding Spring Drive (CAL.7R68) limited edition from SEIKO.
- 2002 ● Released the manual-winding Spring Drive (CAL.7R88) from CREDOR.
- 2004 ● Released the Grand Seiko automatic winding Spring Drive (CAL.9R65).
- 2007 ● Released the first Grand Seiko chronograph (9R86).
- 2016 ● Released 9R01 8Days which realized a long continuous operating time with three barrels.
- 2020 ● Released Spring Drive 9RA5 which was evolved to have high accuracy and 5-day power reserve.

Spring Drive Mechanism ①

Taste of a Mechanical Watch

+

High accuracy equivalent to a Quartz Watch

That is the concept of the Spring Drive.

Let's start from the drive method of a watch.

The method for driving a watch is divided into two types.

They are **mechanical type and quartz type**.

In a mechanical watch, the mainspring is wound and its unwinding power moves the hands.

Amazing mechanism created by high quality craftsmanship,

and admiration goes to skilled craftspersons with passion.

You can feel the appreciation and personal touch of the craftspersons in the ticking sound.

On the other hand, with quartz watches, the quartz is oscillated by a battery and the hands are turned by a motor.

It is characterized by accuracy using state-of-the-art technology.

What is the Spring Drive like?

This is not a mechanical watch or a quartz watch.

In one word, this is a “**mechanical watch having accuracy equivalent to a quartz watch.**”

The Spring Drive is a self-contained drive system that realizes accuracy equivalent to a quartz watch with only the power of the mainspring and has no battery, motor, or secondary battery.

Accuracy of monthly rate of ± 10 seconds or ± 15 seconds equivalent to a quartz watch is achieved while using a mainspring.

The Spring Drive is Seiko's proprietary mechanism which is made available only by SEIKO's unique combination of skills in both **mechanical and electronic micro-engineering**.

Then, how could it be possible to achieve such a degree of accuracy?

That is explained on the next page.

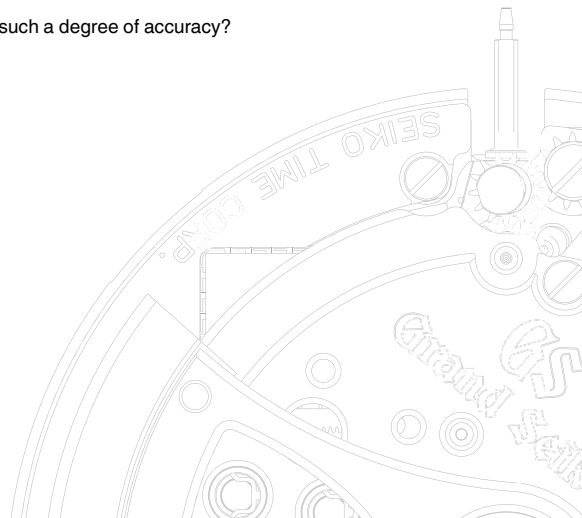

Spring Drive Mechanism ②

The power of the mainspring is regulated by electronic control. That is the essence of the Spring Drive.

What controls the accuracy of a mechanical watch is the balance spring, a part of the speed-regulating unit, called the balance.

This part influences the accuracy to some extent

because it is made of metal which expands and contracts with changes in temperature.

The Spring Drive is

completely different from a mechanical watch in this speed-regulating unit.

The Spring Drive is powered by a mainspring, but adopts an electronic speed-regulating unit comprising a **generator, IC, and crystal oscillator**.

In a little more detail,

at the end of the train wheel that moves the hands, a series of speed increasing wheels with a glide wheel are provided.

The unwinding power of the mainspring rotates the glide wheel, generating electricity in the coil to drive the crystal oscillator and IC.

The IC controls the spinning speed of the glide wheel by applying and releasing the **electromagnetic brake**, while comparing the accuracy of the electric signals generated by the crystal oscillator and the spinning speed of the glide wheel.

In addition, by making the energy transfer of the train wheel efficient and adopting an IC that drives with low power consumption, power reserve far exceeding normal mechanical watches is realized.

An unprecedented drive system which offers **quartz accuracy**.

This is the Spring Drive.

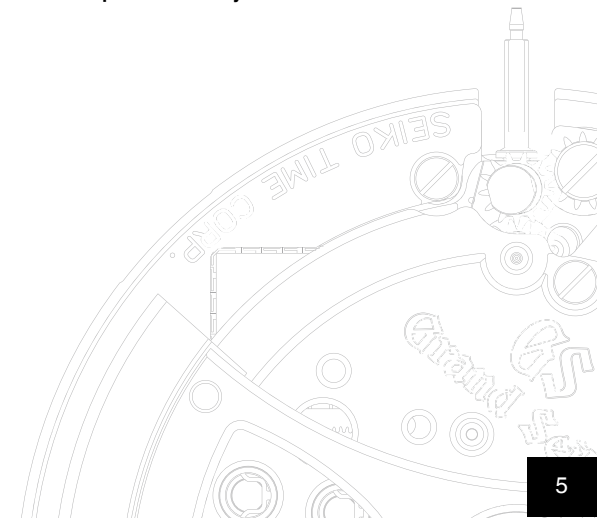

Spring Drive Mechanism ③

Here is the step-by-step description of the Spring Drive in an easy-to-understand manner.
This is how the Spring Drive works.

1

Mainspring

The mainspring is wound by rotation of the oscillating weight (or by turning of the crown), and its unwinding power is the sole power source.

2

Gear train • hands

The unwinding power of the mainspring is transmitted via the gear train to move the hands. No motor or battery is mounted.

3

Tri-synchro regulator

The unwinding power of the mainspring also rotates the glide wheel. This generates small electricity in the coil to drive the IC and crystal oscillator. At the same time, an electric magnetic field is generated on the glide wheel. The IC detects the spinning speed of the glide wheel based on the accuracy of the electric signals of the crystal oscillator, and adjusts the spinning speed of the glide wheel while applying and releasing the electromagnetic brake.

Differences between the Spring Drive and mechanical watch

For the Spring Drive, the mainspring is wound and the unwinding power of the mainspring moves the hands in the same manner as the mechanical watch. It differs from the mechanical watch only in the speed-regulating unit (mechanism for controlling accuracy).

● Temperature change

Accuracy of mechanical watches depends on a balance spring attached to a part called the balance. This part has properties for expanding and contracting with temperature changes, and influences the accuracy of a watch. Accuracy of the Spring Drive is never largely influenced by temperature changes like that of mechanical watches since the crystal oscillator controls it.

(Note) Accuracy of the Spring Drive

Average monthly rate of ± 10 seconds or ± 15 seconds is the accuracy of a watch when it is worn on a wrist at a temperature range between 5°C and 35°C.

● Difference in position

For mechanical watches, the accuracy is influenced even by a difference in position or direction of a watch. This is also caused by the balance that controls the accuracy of mechanical watches. Due to the difference in position, the area where the shaft of the balance contacts with other parts differs, and such differences in resistance influence the accuracy. As the Spring Drive adopts a crystal oscillator not a balance, the accuracy is not influenced by a difference in position.

● Impact

Mechanical watches are susceptible to impacts. If a mechanical watch was subject to impact, amplitude of vibration of the balance (angle for which the balance rotates right and left) is changed, and even the form of the balance spring is changed. In this regard, the Spring Drive is superior to mechanical watches in impact resistance because it adopts a crystal oscillator not a balance.

● Overhaul

Parts that become worn or severely damaged are the balance, pallet fork, and escape wheel & pinion which are collectively called the speed-regulating unit or escapement. These parts "come into contact or collide" mutually and control unwinding of the mainspring. For the Spring Drive, wear and damage occur less than mechanical watches since the spinning speed of the glide wheel is adjusted by a "contact-free" electromagnetic brake. However, as the structure of gear train is the same as mechanical watches, abrasion powder may be generated by contact of the wheels & pinions. An overhaul is recommend every three to four years.

■ HANDLING CAUTIONS

⚠ WARNING To indicate the risks of serious consequences such as severe injuries unless the following safety regulations are strictly observed.

Immediately stop wearing the watch in the following cases.

- If the watch body or band becomes edged by corrosion etc.
- If the pins protrude from the band.
- * Immediately consult the retailer from whom the watch was purchased or Grand Seiko international service network mentioned on CERTIFICATE OF GUARANTEE or our website.

Keep the watch and accessories out of the reach of babies and children.

Care should be taken to prevent a baby or a child accidentally swallowing the accessories. If a baby or child swallows the battery or accessories, immediately consult a doctor, as it will be harmful to the health of the baby or child.

⚠ CAUTION To indicate the risks of light injuries or material damages unless the following safety regulations are strictly observed.

Avoid wearing or storing the watch in the following places.

- Places where volatile agents (cosmetics such as polish remover, bug repellent, thinners, etc.) are vaporizing
- Places where the temperature drops below 5°C or rises above 35°C for a long time
- Places affected by strong magnetism or static electricity
- Places affected by strong vibrations
- Places of high humidity
- Dusty places

If you observe any allergic symptoms or skin irritation

Stop wearing the watch immediately and consult a specialist such as a dermatologist or an allergist.

Other cautions

- Adjustment of the metallic band requires professional knowledge and skill. Please ask the retailer from whom the watch was purchased for replacement of the metallic band, as there is a risk of hand or finger injury and fear of losing parts.
- Do not disassemble or tamper with the watch.
- Keep the watch out of the reach of babies and children. Extra care should be taken to avoid risks of any injury or allergic rash or itching that may be caused when they touch the watch.
- If your watch is of the fob or pendant type, the strap or chain attached to the watch may damage your clothes, or injure the hand, neck, or other parts of your body.
- Please keep in mind that if a watch is taken off and placed down as it is, the case back, the band and the clasp will rub against each other possibly causing scratches on the case back. We recommend placing a soft cloth between the case back, the band and the clasp after taking off your watch.

■ CHECK THE CALIBER NUMBER AND WATER-RESISTANT LEVEL

About the caliber number

The caliber number is a four-digit number that indicates the model of a movement (mechanical part of a watch). The Grand Seiko watch is mounted with an exclusive movement, and the mechanical caliber number starts with "9S", the spring drive caliber number starts with "9R" and the quartz caliber numbers are indicated with 4 digits starting with "9F", "8J" and "4J".

How to check the caliber number

The four-digit model number on the case back is the caliber number.

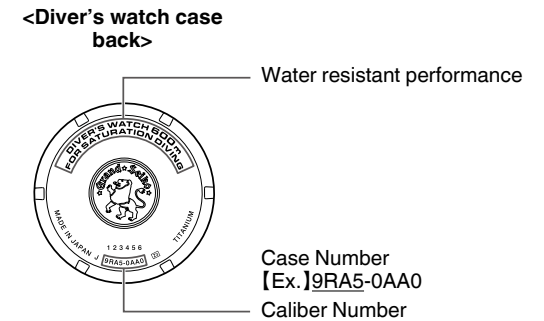

* The above illustrations are examples and may differ from the case back of the watch you purchased.

Water resistance

Refer to the table below for the description of each degree of water resistant performance of your watch before using.

Indication on the case back	Water resistant performance	Conditions of Use
No indication	Non-water resistance	Avoid drops of water or sweat
WATER RESISTANT	Water resistance for everyday life	The watch withstands accidental contact with water in everyday life ⚠ WARNING Not suitable for swimming
WATER RESISTANT 10 (20) BAR	Water resistance for everyday life at 10 (20) barometric pressures	The watch is suitable for diving not using an air cylinder.
DIVER'S WATCH 200m or AIR DIVER'S 200m	The watch can be worn for diving using a compressed air cylinder and can withstand water pressure to a depth of 200 meters.	The watch is suitable for genuine scuba diving use.
DIVER'S WATCH 600m FOR SATURATION DIVING or He GAS DIVER'S 600m	The watch can be worn for diving using helium gas and can withstand water pressure to a depth of 600 meters.	The watch is suitable for saturation diving.

■ CAUTIONS ON WATER RESISTANCE

⚠ CAUTION

Do not turn or pull out the crown when the watch is wet.



Water may get inside of the watch.

* If the inner surface of the glass is clouded with condensation or water droplets appear inside of the watch for a long time, the water resistant performance of the watch is deteriorated. Immediately consult the retailer from whom the watch was purchased or Grand Seiko international service network mentioned on CERTIFICATE OF GUARANTEE or our website.

Do not leave moisture, sweat and dirt on the watch for a long time.



Be aware of a risk that a water resistant watch may lessen its water resistant performance because of deterioration of the adhesive on the glass or gasket, or the development of rust on stainless steel.

Do not wear the watch while taking a bath or a sauna.



Steam, soap or some components of a hot spring may accelerate the deterioration of water resistant performance of the watch.

If water-resistant level of your watch is defined as “WATER RESISTANT”

⚠ WARNING

Do not use the watch in scuba diving or saturation diving.



The various tightened inspections under simulated harsh environment, which are usually required for watches designed for scuba diving or saturation diving, have not been conducted. For diving, use watches specifically designed for diving.

⚠ CAUTION

Do not pour running water directly from faucet.



The water pressure of tap water from a faucet is high enough to degrade the water resistant performance of a water resistant watch for everyday life.

If water-resistant level of your watch is defined as “DIVER’S WATCH 200m” or “AIR DIVER’S 200m”

⚠ WARNING

- Never use the watch in saturation diving using helium gas.
- While diving, never operate the watch in any other manner than described in this instruction manual.

⚠ CAUTION

Before using the diver’s watch, you have to be properly trained in various types of diving and possess the requisite experience and skill to dive safely. When diving, strictly abide by the rules of diving.

If water-resistant level of your watch is defined as “DIVER’S WATCH 600m FOR SATURATION DIVING” or “He GAS DIVER’S 600m”

⚠ WARNING

- This product is compatible with saturation diving. Do not use this product for saturation diving unless you have acquired the requisite experience and techniques for safe saturation diving, thoroughly familiarized yourself with the operation and handling of this product, and inspect all functions of this product prior to each dive.
- Make sure you carefully check the depth rating indicated on the watch dial or on the case back, and never use the watch underwater deeper than the specified depth.
- While diving, never operate the watch in any other manner than described in this instruction manual.

⚠ CAUTION

Before using the diver’s watch, you have to be properly trained in various types of diving and possess the requisite experience and skill to dive safely. When diving, strictly abide by the rules of diving.

Precautions for diving (common during scuba diving and saturated diving)

○ Before diving

Inspect the following items before diving.
 "NAMES OF THE PARTS" → P. 14

- ① The time is correctly set.
- ② The power reserve indicator shows the level of remaining power not less than one-half. If the remaining power shows less than one-half, turn the crown to wind the mainspring.
 "Power reserve indicator" → P. 16
 "How to wind the mainspring" → P. 17
- ③ The rotating bezel turns smoothly. (The bezel rotation must not be too loose or too tight.)
 "Unidirectional rotating bezel" → P. 19
- ④ The crown is completely screwed in.
 "Screw down crown" → P. 15
- ⑤ No abnormalities such as flaws or cracks exist on the band or glass.
- ⑥ The band is reliably fixed with spring bars, buckles or other parts.

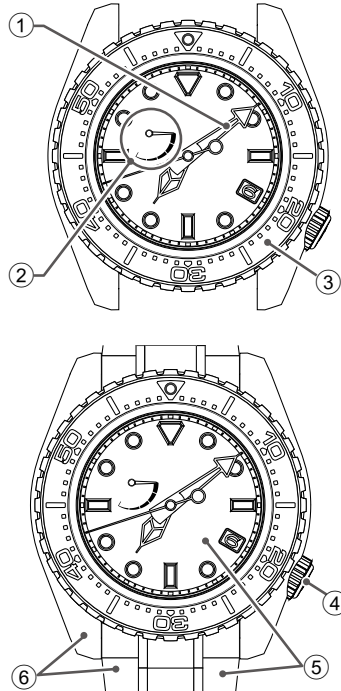

⚠ CAUTION

If you notice any abnormalities, contact the retailer from whom the watch was purchased or Grand Seiko international service network mentioned on CERTIFICATE OF GUARANTEE or our website.

○ While diving

Make sure to observe the following instructions when you wear the watch while diving.



Wear the watch within the water depth indicated on the dial.

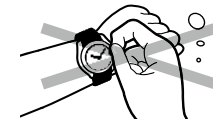

Do not operate the crown or buttons underwater.



Take care not to bump the watch against hard objects such as rocks.



Bezel rotation may become slightly harder underwater, but this is not a malfunction.

○ After diving

Please follow the care instructions below after diving.

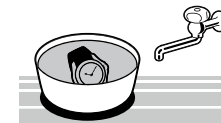

Rinse the watch in fresh water and wipe it thoroughly dry.
 Do not pour running water directly from a faucet onto the watch. Soak the watch in a container filled with water to wash it.

■ NAMES OF THE PARTS

9RA5 (Diver's model)

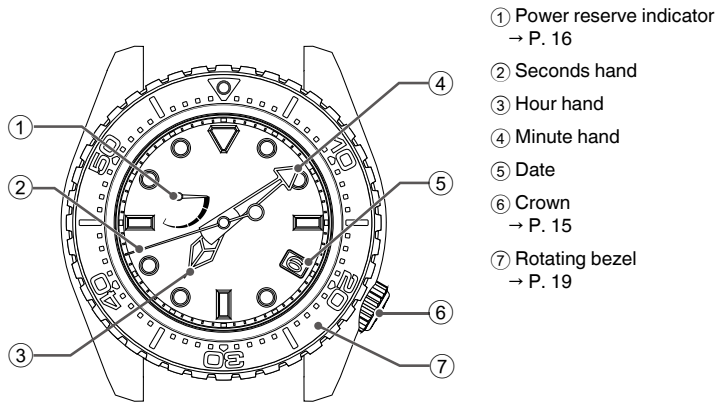

How to set the time and date → P. 17
FUNCTIONS OF DIVER'S MODEL → P. 19
Precautions for diving → P. 12

* The orientation and design of the display may vary depending on the model.

■ HOW TO USE

Crown

There are two types of crowns, the regular one and one that can be locked. Please confirm the crown of the watch that you are using.

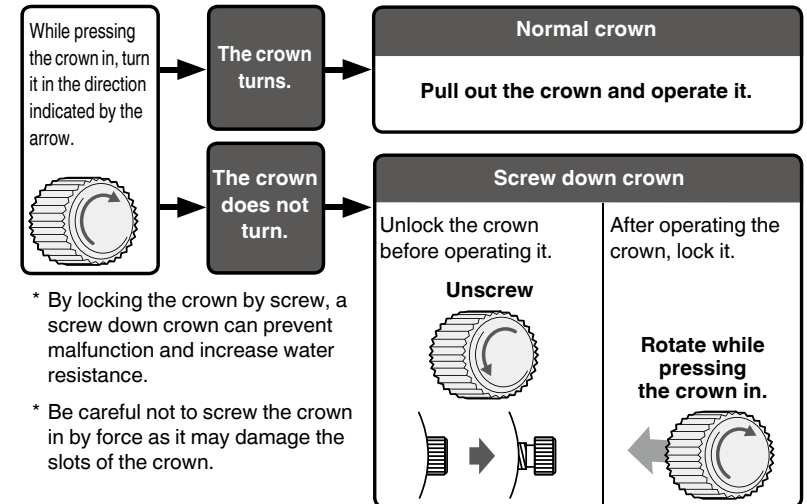

* Turn the crown from time to time. → P. 23

Screw down crown

The screw down crown features a mechanism that can securely lock the crown when it is not being operated in order to prevent any operational errors and to improve its water resistant performance.

- It is necessary to unlock the screw down crown before operating it.
- Once you have finished operating the crown, make sure to relock it.

[To unlock the crown]

Turn the crown counterclockwise (6 o'clock direction) to unscREW it. Now the crown can be operated.

[To lock the crown]

Turn the crown clockwise (12 o'clock direction) while gently pressing it in toward the watch body until it stops.

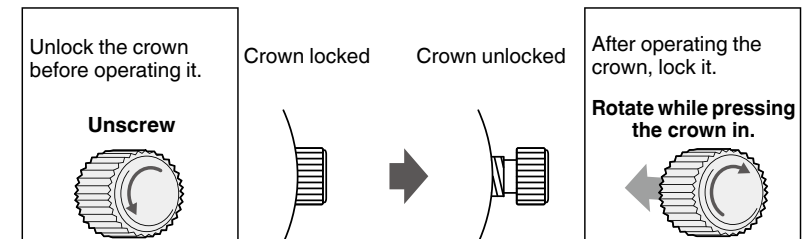

* When locking the crown, turn it slowly with care, ensuring that the screw is properly engaged. Be careful not to push it in forcefully, as doing so may damage the screw hole in the case.

Power reserve indicator

The power reserve indicator lets you know the winding state of the mainspring.

Before removing the watch from your wrist, observe the power reserve indicator to check if the watch has stored enough power to keep running until the next time you wear it. If necessary, wind the mainspring.

(To prevent the watch from stopping, wind the mainspring to store the excess power that will allow the watch to run for extra time.)

<FOR CAL. 9RA5>

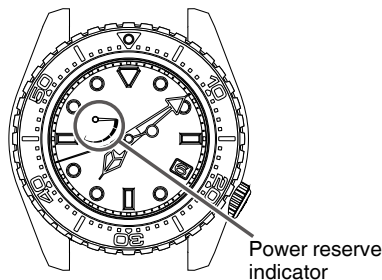

Power reserve indicator

- * The continuous operating time of the watch may vary depending on the condition of use, such as the number of hours you wear the watch or the extent of your movement while wearing it.
- * In a case where you wear the watch for a short period of time, observe the power reserve indicator to check the level of the remaining power. If necessary, manually wind the mainspring.

How to read the power reserve indicator

Power reserve indicator			
Winding state of the mainspring	Fully wound	Half wound	Unwound
Number of hours the watch can run	Approximately 120 hours (5 days)	Approximately 60 hours (2.5 days)	The watch either stops or is running down.

* This watch is configured so that the spring cannot be over-wound. Once the mainspring is fully wound, the mainspring slips inside, disengaging the winding mechanism. When this happens, you can still turn the crown without damaging the watch, however, please refrain from excessive operation of the mainspring.

HOW TO USE

How to wind the mainspring

- This watch is an automatic winding type (with manual winding function).
- The mainspring can be sufficiently wound automatically by natural movement of the arm while normally worn on the wrist. In addition, it can be wound by turning the crown. Please see the power reserve indicator to check the level of the remaining power. “How to read the power reserve indicator”→ P. 16
- When starting to use a stopped watch, it is recommended that you turn the crown to wind the mainspring. To wind the mainspring, unscrew the crown and turn it at the normal position clockwise (12 o'clock direction) slowly. If you turn the crown counterclockwise (6 o'clock direction), it will turn free. Six full rotations of the crown will provide the power to run the watch for approximately ten hours. “Screw down crown”→ P. 15
- If you wear the watch for twelve hours per day consecutively for five to eight days, the watch will be fully wound.
- * Under a low-temperature condition (below 0°C), always keep at least one-fifth of the watch power shown by the power reserve indicator.

CAUTION For models with a screw down crown, remember to screw the crown in.

- CAUTION**
- Do not adjust the date when the time the watch indicates is between 9:00 p.m. and 1:00 a.m.
If the date is adjusted in this condition, the date may not change properly the following day, or a malfunction may occur.
 - If you set the date when the time the watch indicates is between 9:00 p.m. and 1:00 a.m., pull out the crown to the second click, and turn it counterclockwise (6 o'clock direction) to advance the hour hand until it passes 1:00 a.m. temporarily, and then set the date.

How to set the time and date

This watch is equipped with the date display function. The date changes once every 24 hours at around midnight.
Therefore, if the a.m./p.m. is incorrectly set, the date will change around 12:00 p.m.

- ① Pull out the crown to the first click. (If the watch is equipped with the screw down crown, unscrew the crown before pulling it out.)
- ② The date can be adjusted by turning the crown counterclockwise (6 o'clock direction). First turn the crown counterclockwise until the previous day's date from the desired date appears.

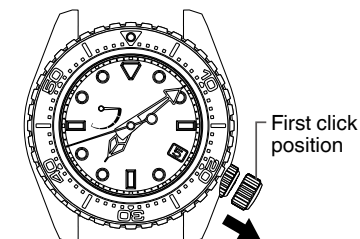

[Ex.] If you want to set the date to “6,” set the date to “5” by turning the crown counterclockwise.

- ③ Pull out the crown to the second click when the seconds hand is at the 12 o'clock position. (The seconds hand stops.)
Turn the crown counterclockwise (6 o'clock direction) to advance the hands until the desired date appears. If the date changes, it means that the watch is set in the morning. Turn the crown further until the watch is set to the current time.

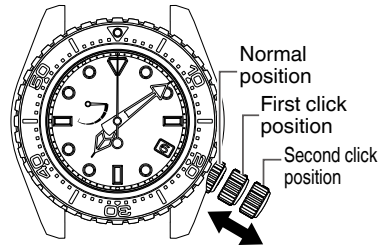

- ④ Push the crown back into the normal position. The watch starts operating.

Date adjustment at the end of the month

It is necessary to adjust the date after February (which has 28 days, 29 days in a leap year) and a 30 day month.

- [Ex.] To adjust the date in the a.m. period on the first day of a month following a 30-day month "31" is displayed instead of "1". Pull out the crown to the first click. Turn the crown counterclockwise (6 o'clock direction) to set the date to "1", and push the crown back in to the normal position.

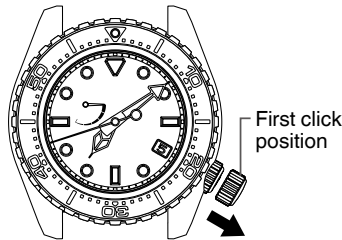

CAUTION For models with a screw down crown, remember to screw the crown in.

Tips for more accurate time setting

To ensure effective operation of the Spring Drive mechanism, observe the following instructions when you set the time.

- ① Before setting the time, make sure to wind the mainspring sufficiently. (Ensure that the power reserve indicator is showing a full-wound state.)
- ② When starting to use a watch after it stops, wind the mainspring sufficiently. To set the time after that, wait for approximately 30 seconds after the seconds hand starts moving, then pull the crown out to the second click.
- ③ The seconds hand will stop moving when the crown is pulled out to the second click. Do not stop the movement of the seconds hand for longer than 30 minutes. If the stoppage of the seconds hand movement exceeds 30 minutes, push the crown back in, and wait for approximately 30 seconds after the seconds hand restarts moving, and then set the time.

CAUTION For models with a screw down crown, remember to screw the crown in.

FUNCTIONS OF DIVER'S MODEL

Unidirectional rotating bezel

By using the rotating bezel, you can measure the elapsed time since the start of an event or an activity such as diving.

This watch has a unidirectional rotating bezel. As the evaluation of the remaining air in your cylinder is based on the information of the elapsed time of the dive, the rotating bezels for a diver's watch is designed to rotate only counterclockwise, so that the watch is prevented from displaying the elapsed time shorter than it actually is.

CAUTION Make sure that you check the correct remaining amount of air in your cylinder before diving. Use the display of the elapsed time by the rotating bezel only as a guide during diving.

How to use the rotating bezel

- ① At the start of the activity, for which you want to measure the elapsed time (for example, when you start diving), rotate the bezel so that the  mark on the bezel is aligned with the minute hand.
- ② Read the graduation on the rotating bezel to which the minute hand is pointing.

[Ex.] When you start diving at 10:10.

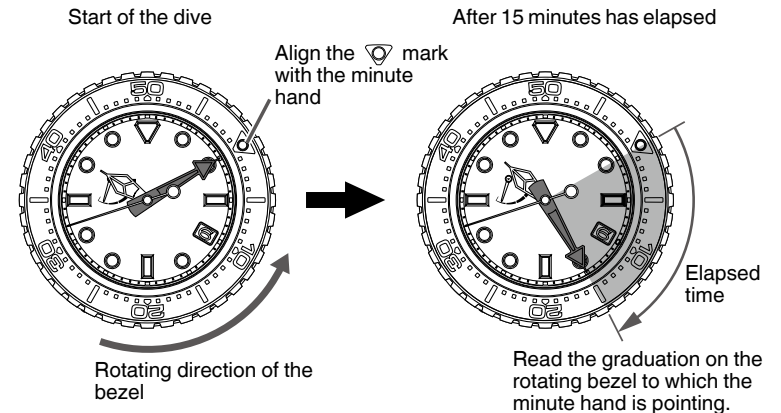

Slide adjuster

If your watch has a metallic band equipped with a slide adjuster mechanism, you can easily adjust the bracelet length by yourself. This is very useful when you wear the watch over a wetsuit or a heavy winter clothing.

How to use the slide adjuster

- ① Lift up the flap approximately 90° and press it down further approximately 20°, and hold it there.
* You may feel slight resistance, but doing this requires only a light force. Please do not push the flap down forcibly.
- ② Lightly pull the bracelet on the 6 o'clock side of the watch along the curved line of the bracelet.
* Again, doing this requires only a light force. Please do not pull the bracelet forcibly.
* The slider can be pulled out approximately 30 mm. Be careful not to pull it out beyond the limit mark inscribed on it.

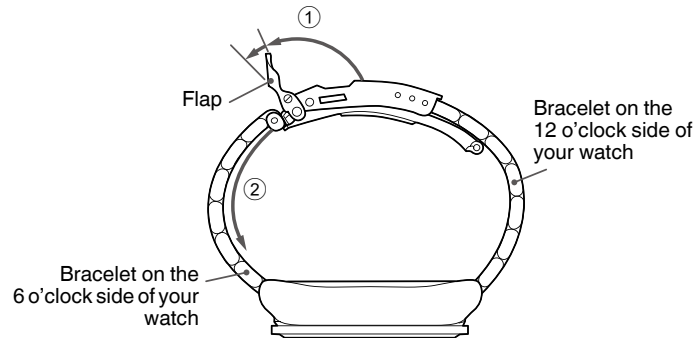

- ③ Holding down the push button, lift up the clasp to release the buckle, and strap the watch on your wrist.
- ④ Close the clasp first (4-1) and then the flap (4-2).
- ⑤ With the hand which is not wearing the watch, adjust the length of the slider so that the watch fits well around your wrist.

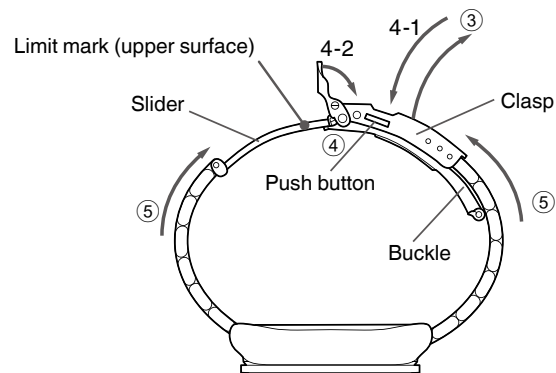

TO PRESERVE THE QUALITY OF YOUR WATCH

After-sale service

Notes on guarantee and repair

- Contact the retailer from whom the watch was purchased or Grand Seiko international service network mentioned on CERTIFICATE OF GUARANTEE or our website for repair or overhaul.
- Within the guarantee period, present the certificate of guarantee to receive repair services.
- Guarantee coverage is provided in the certificate of guarantee. Read carefully and retain it.
- For repair services after the guarantee period has expired, if the functions of the watch can be restored by repair work, we will undertake repair services upon request and payment.

Replacement parts

- Please keep in mind that if original parts are not available, they may be replaced with substitutes whose outward appearance may differ from the originals.

Inspection and adjustment by disassembly and cleaning (overhaul)

- Periodic inspection and adjustment by disassembly and cleaning (overhaul) is recommended approximately once every 3 to 4 years in order to maintain optimal performance of the watch for a long time.
- The movement of this watch has a structure that consistent pressure is applied on its power-transmitting wheels. To ensure these parts work together properly, periodic inspection including cleaning of parts and movement, oiling, adjustment of accuracy, functional check and replacement of worn parts is needed. Inspection and adjustment by disassembly and cleaning (overhaul) within 3 to 4 years from the date of purchase is highly recommended for longtime use of your watch. According to use conditions, the oil retaining condition of your watch mechanical parts may deteriorate, abrasion of the parts may occur due to contamination of oil, which may ultimately lead the watch to stop. As the parts such as the gasket may deteriorate, water-resistant performance may be impaired due to intrusion of perspiration and moisture. Please contact the retailer from whom the watch was purchased for inspection and adjustment by disassembly and cleaning (overhaul). For replacement of parts, please specify "GRAND SEIKO GENUINE PARTS". When asking for inspection and adjustment by disassembly and cleaning (overhaul), make sure that the gasket and push pin are also replaced with new ones.
- When your watch is inspected and adjusted by disassembly and cleaning (overhauled), the movement of your watch may be replaced.

Guarantee

Within the guarantee period, we guarantee free repair/adjustment service against any defects according to the following guarantee regulations, provided that the watch was properly used as directed in this instruction booklet.

Guarantee coverage

- The watch body (movement, case) and metallic band.

Exceptions from guarantee

In following cases, repair/adjustment services will be provided at cost even within the guarantee period or under guarantee coverage.

- Exchange of leather, urethane, or fabric band.
- Scratches or grime to the case, glass, or band, caused by use.
- Troubles or damage caused by accidents or improper usage.
- Troubles and damage caused by acts of God, natural disasters including fire, floods or earthquakes.
- Text in certificate has been altered.
- No certificate is presented.

Procedure to claim free repair services

- For any defects under guarantee, submit the watch together with the attached certificate of guarantee to the retailer from whom the watch was purchased.
- In the case where you cannot accept the guarantee from the retailer from whom the watch was purchased due to gift-giving or relocation, etc., ask Grand Seiko international service network mentioned on CERTIFICATE OF GUARANTEE or our website by attaching the certificate without fail.

Others

- For the watch case, dial plate, hands, glass, band etc., some alternative parts may be used for repair if necessary.
- For length adjustment service of metallic band, ask the retailer from whom the watch was purchased or Grand Seiko international service network mentioned on CERTIFICATE OF GUARANTEE or our website.
Other retailers may undertake the service on a chargeable basis or may not undertake the service.
- Free repair services are guaranteed only under the period and conditions specified in the certificate of guarantee.
It does not affect specific legal rights of a consumer.

Daily care

The watch requires good daily care

- Do not wash the watch when its crown is at the extended position.
- Wipe away moisture, sweat or dirt with a soft cloth.
- After soaking the watch in seawater, be sure to wash the watch in clean pure water and wipe it dry carefully. Do not pour running water directly from a faucet onto the watch. Put some water into a bowl first, and then soak the watch in the water to wash it.

* If your watch is rated as “non-water resistant” or “water resistant for daily use”, do not wash the watch.

“CHECK THE CALIBER NUMBER AND WATER-RESISTANT LEVEL”→ P. 9

Turn the crown from time to time

- In order to prevent corrosion of the crown, turn the crown from time to time.
- The same practice should be applied to a screw down crown.
“Crown”→ P. 15

Band

The band touches the skin directly and becomes dirty from sweat or dust. Therefore, lack of care may accelerate deterioration of the band or cause skin irritation or stain on the sleeve edge. The watch requires a lot of attention for long usage.

Metallic band

- Moisture, sweat or soil will cause rust even on a stainless steel band if they are left for a long time.
- Lack of care may cause a yellowish or gold stain on the lower sleeve edge of shirts.
- Wipe off moisture, sweat or soil with a soft cloth as soon as possible.
- To clean the soil around the joint gaps of the band, wipe it out in water and then brush it off with a soft toothbrush (Protect the watch body from water splashes by wrapping it up in plastic wrap etc.)
Wipe off the remaining moisture with a soft cloth.
- Because some titanium bracelets use pins made of stainless steel, which has outstanding strength, rust may form in the stainless steel parts.
- If rust advances, pins may poke out or drop out, and the watch case may fall off the bracelet, or the clasp may not open.
- If a pin is poking out, personal injury may result. In such a case, refrain from using the watch and request repair.

Leather band

- Wipe off moisture and sweat as soon as possible by gently blotting them up with a dry cloth.
- Do not expose the watch to direct sunlight for a long time.
- Please take care when wearing a watch with light-colored band, as dirt is likely to show up.
- Refrain from wearing a leather band watch other than Aqua Free bands while swimming, and when working with water even if the watch itself is water-resistant enforced for daily use (10-BAR/20-BAR water resistant).

Silicone band

- As for material characteristics, the band is easily dirtied, and may be stained and discolored. Wipe off dirt with a wet cloth or wet tissue.
- Unlike bands of other materials, cracks may result in the band being cut. Take care not to damage the band with an edged tool.

Notes on skin irritation and allergy

Skin irritation caused by a band has various reasons such as allergy to metals or leathers, or skin reactions against friction on dust or the band itself.

Notes on the length of the band

Adjust the band to allow a little clearance with your wrist to ensure proper airflow. When wearing the watch, leave enough room to insert a finger between the band and your wrist.



Magnetic resistance (Magnetic influence)

Affected by nearby magnetism, a watch may temporarily gain or lose time or stop operating.

Indication on the case back	Conditions of use	Certified level
No indication * For diver's model	Keep the watch more than 5 cm away from magnetic products.	4,800 A/m
	Keep the watch more than 1 cm away from magnetic products.	16,000 A/m
MAGNETIC RESISTANT 40000A/m	The watch can maintain its performance in most cases where it is brought close to (at least 1 cm spaced from) magnetic products not only in normal daily life circumstances but also in a special work environment.	40,000 A/m

* A/m (ampere meter) is the international unit (SI unit) for indicating the magnetic field.

If the watch becomes magnetized and its accuracy deteriorates to an extent exceeding the specified rate under normal use, the watch may need to be demagnetized. In this case, you will be charged for demagnetization and accuracy readjustment even if it happens within the guarantee period.

Examples of common magnetic products that may affect watches

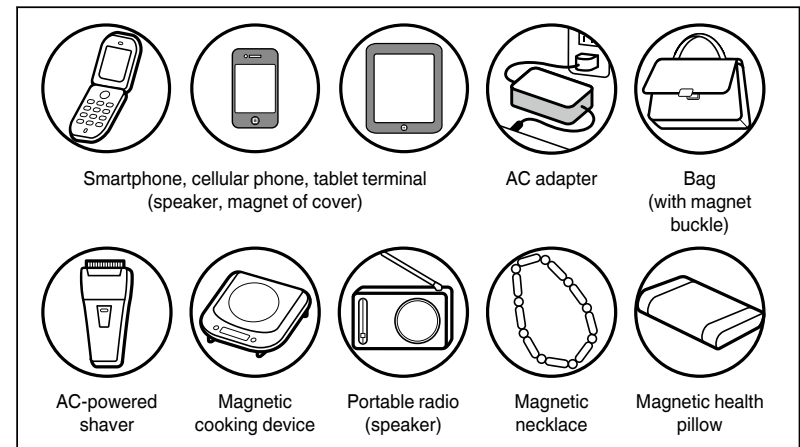

The reason why this watch is affected by magnetism

The built-in speed-regulating mechanism is provided with a magnet, which may be influenced by a strong external magnetic field.

Lumibrite

If your watch has Lumibrite

Lumibrite is a luminous paint that absorbs light energy of the sunlight and lighting apparatus in a short time and stores it to emit light in the dark. For example, if exposed to a light of more than 500 lux for approximately 10 minutes, Lumibrite can emit light for 3 to 5 hours. Please note, however, Lumibrite emits the light it stores, the luminance level of the light decreases gradually over time. The duration of the emitted light may also differ slightly depending on such factors as the brightness of the place where the watch is exposed to light and the distance from the light source to the watch.

* In general, when you enter a dark place from a bright environment, your eye cannot adapt to the change in light levels quickly. At first, you can hardly see anything, but as time passes, your vision gradually improves. (Dark adaptation of the human eye)

* Lumibrite is a luminous paint that is completely harmless to human beings and the natural environment, containing no noxious materials such as radioactive substance.

Reference data on the luminance

Condition		Illumination
Sunlight	Fine weather	100,000 lux
	Cloudy weather	10,000 lux
Indoor (Window-side during daytime)	Fine weather	more than 3,000 lux
	Cloudy weather	1,000 to 3,000 lux
	Rainy weather	less than 1,000 lux
Lighting apparatus (40-watt daylight fluorescent light)	Distance to the watch: 1 m	1,000 lux
	Distance to the watch: 3 m	500 lux (average room luminance)
	Distance to the watch: 4 m	250 lux

Troubleshooting

Troubles	Possible Causes	Solutions
The watch stops operating.	The mainspring has not been wound.	Turn the crown to wind the mainspring and reset the time. While you are wearing the watch or when you take it off, check the remaining power shown by the power reserve indicator and wind the mainspring if necessary.
The watch stops even though the power reserve indicator is not showing "0".	The watch has been left at a low temperature (below 0°C).	Turn the crown to wind the mainspring and reset the time. At a temperature below 0°C, the watch may stop if the power reserve indicator is showing less than one-fifth of the power reserve.
The watch temporarily loses/gains time.	The watch has been left in extremely high or low temperatures for a long time.	Return the watch to a normal temperature so that it works accurately as usual, and then reset the time. The watch has been adjusted so that it works accurately when it is worn on your wrist under a normal temperature range between 5°C and 35°C.
	The watch was brought into close contact with a magnetic object.	Correct this condition by moving and keeping the watch away from the magnetic source, and reset the time. If this action does not correct the condition, contact the retailer from whom the watch was purchased.
	The watch was dropped, worn while playing active sports, hit against hard surfaces, or exposed to strong vibrations.	Reset the time. If the watch does not return to its normal accuracy after resetting the time, contact the retailer from whom the watch was purchased.
The date changes during daytime.	A.m./P.m. is not correctly set.	When you set the time, note that the moment the date changes is midnight. When setting the hour hand, be sure that A.m./P.m. is correctly set.
Even though you wear the watch every day, the power reserve indicator does not move up.	The watch is worn on your wrist only for a short period of time, or the amount of arm movement is small.	Wear the watch for an extended period of time. Or turn the crown to wind the mainspring.
Right after starting the watch, it seems that the seconds hand moves more quickly than usual when setting the time.	When the watch starts moving, it takes a little time before the speed-regulating unit starts operating. (This is not a malfunction.)	It takes several seconds before the speed-regulating unit starts operating. To set the time correctly, wait for approximately 30 seconds after the seconds hand starts to move, and set the time.
Blur in the display persists.	Small amount of water has got inside the watch due to deterioration of the gasket, etc.	Consult the retailer from whom the watch was purchased.

* For the solution of troubles other than above, contact the retailer from whom the watch was purchased.

■ SPECIFICATIONS (Movement)

Caliber no.	9RA5
Features	Hour hand, minute hand, seconds hand, date indicator, power reserve indicator (10 o'clock position)
Frequency of crystal oscillator	32,768 Hz
Loss/gain	Average monthly rate of ± 10 seconds (equivalent to daily rate of ± 0.5 second) ^{*1}
Operational temperature range	-10°C to $+60^{\circ}\text{C}$ ^{*2}
Driving system	Automatic winding type with manual winding function
Hand movement	Glide motion
Power reserve	Approx. 120 hours (5 days) ^{*3}
IC (Integrated Circuit)	Oscillator, frequency divider, and spring drive control circuit (C-MOS-IC): 1 piece
Jewels	38 jewels

*1 The average rate is estimated in a condition when the watch is worn on your wrist within a temperature range between 5°C and 35°C .

*2 Under a low-temperature condition (below 0°C), always keep at least one-fifth of the watch power shown by the power reserve indicator.

*3 When the power reserve indicator shows the power supplied by the mainspring is full, continuous operating time may be shortened depending on the how the product is used.

* The specifications are subject to change without prior notice due to product improvement.