

CONTENTS

1. Main Features	3
2. Component Parts and their Functions	4
3. Switching Digital Functions (Modes)	6
4. How to Call the Time or Calendar of Each City in the World	7
5. How to Turn on the EL Light	9
6. Setting the Analog Time	10
7. Setting the Digital Time [TME]	11
8. Using the Calendar [CAL]	13
9. Using the Alarm [AL1/AL2]	16
10. Using the Chronograph [CHR]	18
11. Using the Timer [TMR]	20
12. Using the Zone Set Mode [SET]	23
13. Low Battery Warning Function	25
14. All Reset Function	26
15. Precautions	27
16. Specifications	33

1. Main Features

This watch is a combination quartz watch equipped with world time functions which can easily call and display through button operations the time and calendar of 30 cities in the world and UTC (Coordinated Universal Time).

In addition to the alarm, chronograph and timer, it is equipped with an EL light function to allow you to see the display in the dark.

2. Component Parts and their Functions

Name of Parts/Modes		Time	Calendar	Alarm 1	Alarm 2	Chronograph	Timer	Zone Set	
Ⓐ	Button Ⓐ	Press button once	EL light illuminated		ON/OFF switching	ON/OFF switching	Start/Stop	Start/Stop	EL light illuminated
		Press button for 2 seconds or longer			Alarm monitor	Alarm monitor	–	–	
Ⓑ	Button Ⓑ	Press button once	Switching of city	Switching of city	Switching of city	Switching of city	Split/Reset	Restart/Reset	Switching of city
		Press button for 2 seconds or longer	To correction state	To correction state	To correction state	To correction state	–	–	To correction state
Ⓜ	Button Ⓜ	Press button once	Switching of mode			Switching of mode			
①	Mode mark	TM E	CAL	AL1	AL2	CHR	TM R	SET	
②	Digital display	Hour, Minute, Second, City Name	Month, Date, City name or Day	Hour, Minute, On/OFF, City name	Hour, Minute, On/OFF, City name	Hour, Minute, Second, 1/100 seconds	Minute, Second, Set time (minute)	Hour, Minutes, On/OFF, City name	
③	Time difference display from UTC	Display the time difference of indicated cities from UTC			Display the time difference of indicated cities from UTC				
④	Crown	To be used to set analog time			To be used to set analog time				
⑤	Hour hand	Always indicates "hours"			Always indicates "hours"				
⑥	Minute hand	Always indicates "minutes"			Always indicates "minutes"				
⑦	Second hand	Always indicates "seconds"			Always indicates "seconds"				

3. Switching Digital Functions (Modes)

This watch has the following functions (modes).
 Every time the button **M** is pressed, the mode is changed sequentially. With the mode mark, you can check the current mode.

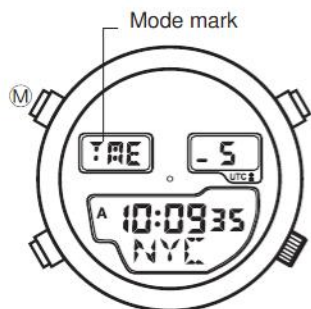

Mode Mark	Mode (Function)
TME	Time
CAL	Calendar
AL1	Alarm 1
AL2	Alarm 2
CHR	Chronograph
TMR	Timer
SET	Zone Set

* If no button operation is done for 2 minutes or longer in Alarm 1, Alarm 2 and Zone Set modes, the watch will automatically return to Time mode.

4. How to Call the Time or Calendar of Each City in the World

You can easily call through button operations the time or calendar of a city set to "On (display)" in the Zone Set mode.

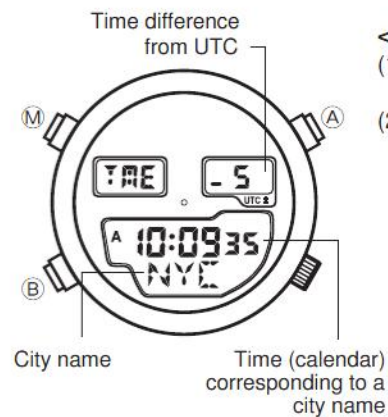

<Operation Method>

- (1) Select the time mode or calendar mode by pressing the button **M**.
- (2) Every time the button **B** is pressed, the time or calendar of the next city is displayed in the order (in the direction to increase time difference) shown in the table on the following page. Every time the button **A** is pressed with the button **B** pressed, the time or calendar of the next city is displayed in the reverse direction (direction to decrease the time difference).

Cities and Time Difference from UTC (Universal Time Coordinated) Displayed by This Watch

	Watch display	Name of City	Time Difference	Summer time		Watch display	Name of City	Time Difference	Summer time
1	UTC	Universal Time Coordinated	±0	—	17	TYO	Tokyo	+9	×
2	LON	London	±0	○	18	SYD	Sydney	+10	○
3	PAR	Paris	+1	○	19	NOU	Nouméa	+11	×
4	ROM	Rome	+1	○	20	AKL	Auckland	+12	○
5	CAI	Cairo	+2	○	21	HNL	Honolulu	-10	×
6	IST	Istanbul	+2	○	22	ANC	Anchorage	-9	○
7	MOW	Moscow	+3	○	23	LAX	Los Angeles	-8	○
8	KWI	Kuwait	+3	×	24	DEN	Denver	-7	○
9	DXB	Dubai	+4	×	25	CHI	Chicago	-6	○
10	KHI	Karachi	+5	×	26	MEX	Mexico City	-6	×
11	DEL	New Delhi	+5.5	×	27	NYC	New York	-5	○
12	DAC	Dacca	+6	×	28	YUL	Montreal	-5	○
13	BKK	Bangkok	+7	×	29	CCS	Caracas	-4	×
14	SIN	Singapore	+8	×	30	RIO	Rio de Janeiro	-3	○
15	HKG	Hong Kong	+8	×	31	BUE	Buenos Aires	-3	×
16	PEK	Beijing	+8	×					

8

- * It is possible to change through the same operations the city display in the Alarm 1 mode, Alarm 2 mode, and Zone Set mode.
- * A city set to non-display (OFF) in the Zone Set mode is not displayed.
- * Mark ○ in the table indicates a city (region) implementing summer time and mark × a city (region) not implementing it.
- * The time difference and summer time implementation in the table may change depending on the circumstances of each country. (The table as of year 1999)

5. How to Turn on the EL Light

- If the button (A) is pressed in the Time, Calendar, or Zone Set mode, the EL light turns on. While the button is pressed, the EL light is kept turned on.
- The EL light turns on at the time of split time or stop operation during chronograph measuring.

9

6. Setting the Analog Time

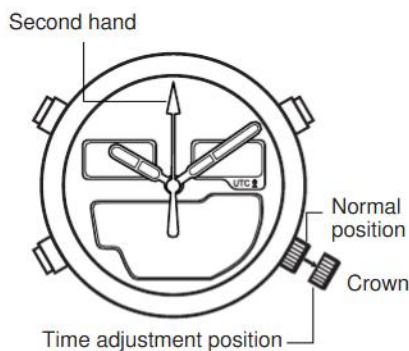

- (1) When the crown is pulled, the second hand stops.
- (2) Turn the crown and set the hands to the correct time.
- (3) After the time is adjusted, push the crown neatly to its normal position. When the crown is pushed in, the second hand starts.

* Stop the second hand at the 0 position and then press the crown when the digital display reaches zero seconds. The second hand will start moving in synchronization with the digital display.

10

7. Setting the Digital Time [TME]

If the time of any of 30 cities and UTC is adjusted, the time of other cities is automatically calculated and corrected on the basis of time difference.

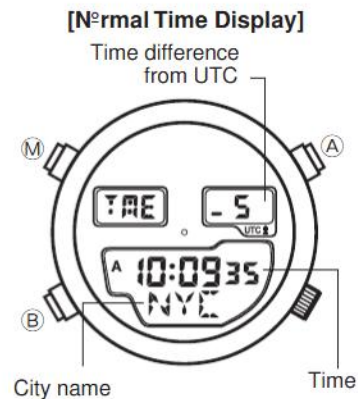

- (1) Press button (M) to set the Time mode [TME].
- (2) Press the button (B) to show a city whose time is to be corrected.
- (3) If the button (B) is pressed continuously for about 2 seconds, "SMT (abbreviation of summer time)" and "On" or "OF" blink and watch enter the correction state. The blinking figures can be corrected.
- (4) Press the button (A) and switch summer time setting (On) or non-setting (OF) of the city.
- (5) Every time the button (B) is pressed, the blinking figures change in the sequence of [second → minute → hour → 12 hours/24 hours]. Have a desired figures blink.

11

- (6) Press the button (A) to correct the blinking figures.
- If the button (A) is pressed in the state of second correction, the second is corrected to 00. (When the second is 30 to 59, the minute is carried 1 minute.)
 - Every time the button (A) is pressed in the state of hour or minute correction, the display advances one by one, and press and hold button (A) for rapid advancement.
 - 12/24 hour system switching is done every time the button (A) is pressed.
- (7) Press the button (M) to return to the normal display.

- * If the summer time is set (On), the time is advanced 1 hour from the current time, and "SMT" is shown in the digital display. No summer time is available for UTC.
- * Make sure that the AM/PM indication is correct when setting the time in the 12-hour display system.
- * Auto-Return to the normal Time display will be activated when the watch is left in the correction state (blinking display) for about 2 minutes.
- * If the button (M) is pressed in the Time correction state, a quick return is made to the normal Time display.

8. Using the Calendar [CAL]

Every time the button (A) is pressed for 2 seconds or longer in the calendar mode, city name display and day of week display are changed.

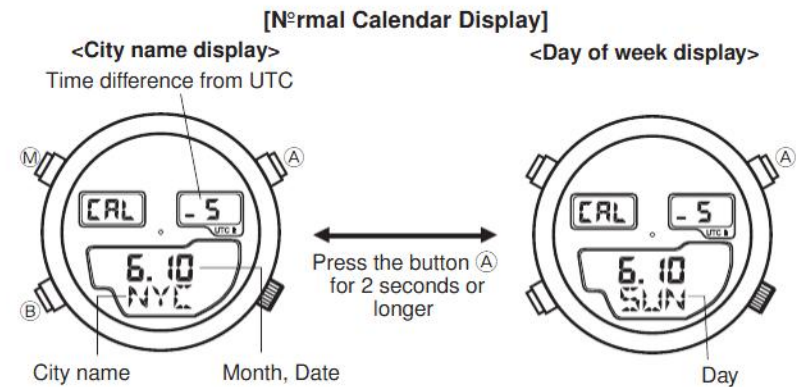

<Setting the Calendar>

If the calendar of any of 30 cities and UTC is set, the calendar of other cities is automatically calculated and corrected on the basis of the time difference.

- (1) Press the button **(M)** to set the calendar mode (city name display).
- (2) Press the button **(B)** and show a city whose calendar is to be corrected.
- (3) If the button **(B)** is pressed continuously for about 2 seconds, "Month" blinks and watch enter the correction state. The blinking figures can be corrected.
- (4) Every time the button **(B)** is pressed in the correction state, the blinking figures change in the sequence of [Month → Date → Year]. Have a desired figure blink.
- (5) Press the button **(A)** to correct the blinking figures. (Press and hold button **(A)** for rapid advancement)
- (6) Press the button **(M)** to return to the normal display.

- * Auto-Return to normal Calendar display will be activated when the watch is left in Calendar correction state for about 2 minutes.
- * If the button **(M)** is pressed in the Calendar correction state, a quick return is made to the normal Calendar display.
- * Calendar can be set from 2001 through 2099 (displayed only at the time of correction).
- * Day of the week is automatically set with adjustment of Year, Month and Date.
- * The calendar is a full auto calendar. Once it is set, no month-end correction including the leap year is required.
- * If the calendar is set to a non-existing day, it is automatically corrected to the first day of the following month when the normal display is restored. (Example : February 30 → March 1)

9. Using the Alarm [AL1/AL2]

Alarm 1 and Alarm 2 are different in sound only, and operating methods etc. are all same. Once the alarm is set (On), the alarm sounds for about 15 seconds at the set time every day. The alarm is stopped by pressing any of the buttons.

[Normal Alarm Display "ON"]

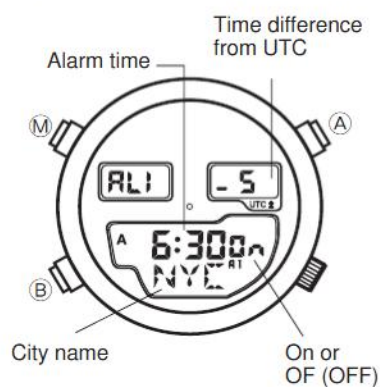

16

<How to Set Alarm>

- (1) Press the button **M** to set Alarm 1 or Alarm 2 mode.
- (2) Press the button **B** to show a city whose alarm is to be set.
- (3) If the button **B** is pressed continuously for about 2 seconds, the alarm is turned On and "Hour" blinks.
- (4) Press the button **A** to correct the "Hour." (Press and hold button **A** for rapid advancement.)
- (5) Press the button **B** to blink the "Minute".

- (6) Press the button **A** to correct the "Minute."
- (7) Press the button **M** to return to the normal display.

- * If the watch is set to 12-hour display of Time mode, Alarm will also be set to 12-hour display.
- * Auto-Return to normal Alarm display will be activated when the watch is left in Alarm correction state for about 2 minutes.
- * If the button **M** is pressed in the Alarm correction state, a quick return is made to the normal Alarm display.

<To Switch Alarm On/OFF>

When button **A** is pressed in normal Alarm display, "On" and "OF (OFF)" are changed each time the button is pressed. When Alarm is set to "On", "A1" or "A2" turns on in the digital display.

<Alarm Monitor>

Press and hold button **A** in Alarm mode to make the Alarm monitor sound.

17

10. Using the Chronograph [CHR]

This chronograph allows you to measure and display to maximum "23 hours 59 minutes 59 seconds 99" in units of 1/100 of a second. After the completion of 24-hour measurement, it returns to the reset display and stops. It is also possible to measure split time (elapsing time).

[Chronograph Reset Display]

Time difference from UTC



Hour, minute, second,
1/100 seconds

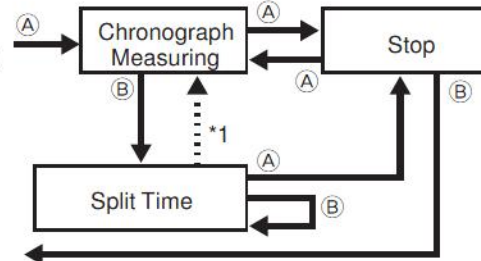

*1: Auto-Return after 10 seconds.

<Elapsed Time Measurement>

- (1) Press the button **M** to set the chronograph mode.
- (2) When the button **A** is pressed, it starts, and if the button **A** is pressed while measuring, it stops. Each time you press button **A**, start/stop is repeated.
- (3) If the button **B** is pressed while stopped, it returns to the reset display.

<Split Time Measurement>

Every time the button **B** is pressed during chronograph measuring, the newest split time is displayed for about 10 seconds. (During the split display, "SPL" blinks in the mode mark display portion.)

* The mode can be changed by pressing the button **M** even during the chronograph measuring. If the mode is returned to the chronograph mode again, the continued measuring can be displayed. If the measuring exceeds 24 hours, however, return is made to the reset display.

11. Using the Timer [TMR]

Timer can be set in units of 1 minute up to 60 minutes.
When the timer measuring is completed, the time-up sounds for about 5 seconds.

[Timer Setting Display]

Time difference from UTC



Set time (minutes)

Remaining time
(Minute, second)

<To Set Timer>

- (1) Press the button **M** to set the timer mode.
- (2) Every time the button **B** is pressed, the set time is corrected -1 minute.
(Press and hold button **B** for rapid advancement.)

<To Set Timer Measurement>

- (1) Press the button **M** to set the timer mode.
- (2) If the button **A** is pressed, the timer starts from the set time.
- (3) If the button **A** is pressed during measuring, it stops, and if the button **A** is pressed again, it restarts.
- (4) If the button **B** is pressed during stoppage, it returns to the set time.

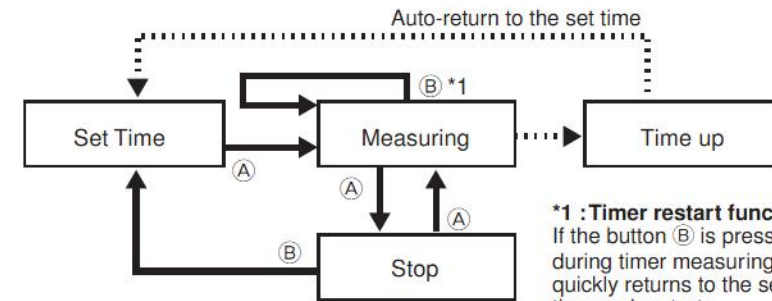

***1 : Timer restart function**
If the button **B** is pressed during timer measuring, it quickly returns to the set time and restarts.

* The mode can be changed by pressing the button **(M)** even during timer measuring. If it is returned to the timer mode again, the continued measuring can be displayed. If the measuring of the set time is completed, however, it returns to the set time display.

12.Using the Zone Set Mode [SET]

As to the 30 cities and UTC (Coordinated Universal Time) to be displayed by this watch, display setting or non-display setting can be done for each city, and the summer time of each city except UTC can be set. Only the cities having the city display set (On) can be displayed in Timer, Calendar and Alarm modes.

[Normal Zone Set Display]

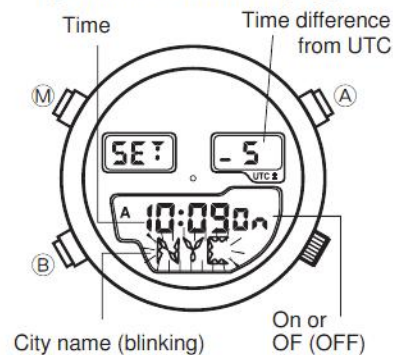

<To Set the Zone Set Mode>

- (1) Press the button **(M)** to set the Zone Set mode.
- (2) Press the button **(B)** and show a city to be set.
- (3) If the button **(B)** is pressed continuously for about 2 seconds or longer, "On" or "OF" blinks.
- (4) Press the button **(A)** to select display (On) or non-display (OF) of the city.
- (5) If the button **(B)** is pressed, "SMT (abbreviation of summer time)" and "On" or "OF" blink.

- (6) Press the button (A) to select the summer time setting (On) or cancel (OF).
In order to set for another city, watch enter the correction state for the next city by pressing the button (B) again. Through the same operations sequentially, display or non-display of cities should be selected and the summer time setting should be done. (The city names can be advanced rapidly by continuously pressing the button (B).)
- (7) After the setting for the cities is completed, press the button (M) to return to the normal display.

- * If the display is set to "OF" for all the cities, the city name to be displayed in each mode is only UTC.
- * Auto-Return to normal Zone Set display will be activated when the watch is left in Zone Set correction state for about 2 minutes.
- * If the button (M) is pressed in the Zone Set correction state, a quick return is made to the normal Zone Set display.

13. Low Battery Warning Function

When the battery approaches its life, the movement of second hand is changed to 2-second interval movement (2-graduation movement every 2 seconds).

Although the time is correctly displayed, the function will be limited as follows.

- EL light does not turn on.
- No sounding of alarm, time-up etc.

In such a case, you are advised to replace the battery as soon as possible.

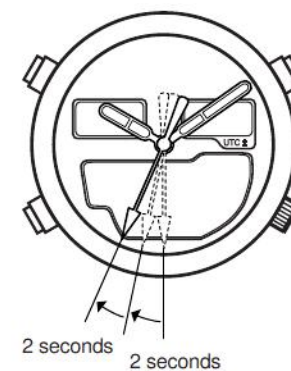

14. All Reset Function

After the battery is replaced, be sure to do the following all-reset operation. If a strong impact or static electricity is applied to the watch, the watch may make abnormal display or malfunction (no display, continuous alarm sounding etc.), though in a rare case. In such a case, do the following all-reset operation.

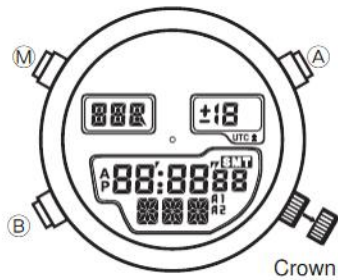

- (1) Pull the crown out.
- (2) Press buttons (A), (B) and (M) simultaneously. (All displays turn on.)
- (3) If the crown is pushed in to its normal position, confirming sound is heard.

This has completed the all-reset operation.
After the all-resetting, correctly set the time and modes before using.





15. Precautions

CAUTION Water-Resistance Performance

There are several types of water-resistant watches, as shown in the following table. For correct use within the design limits of the watch, confirm the level of water-resistance of your watch, as indicated on the dial and case, and consult the table.

- Water-resistance for daily use (to 3 atmospheres): This type of watch is water-resistant to minor exposure to water. For example, you may wear the watch while washing your face; however, it is not designed for use underwater.
- Upgraded water-resistance for daily use (to 5 atmospheres): This type of watch is water-resistant to moderate exposure to water. You may wear the watch while swimming; however, it is not designed for use while skin diving.
- Upgraded water-resistance for daily use (to 10/20 atmospheres): This type of watch may be used for skin diving; however, it is not designed for scuba or saturated diving using helium gas.

(The unit "bar" is roughly equal to 1 atmosphere.)

Indication			Examples of Use				
							
Dial	Case (caseback)	Specification	Minor exposure to water (washing face, rain, etc.)	Moderate exposure to water (washing, kitchen work, swimming, etc.)	Marine sports (skin diving)	Scuba diving (with air tank)	Operation of the crown or button with moisture visible
WATER RESIST or no indication	WATER RESIST(ANT)	Water-resistant to 3 atmospheres	OK	NO	NO	NO	NO
WR 50 or WATER RESIST 50	WATER RESIST(ANT) 5 bar or WATER RESIST (ANT)	Water-resistant to 5 atmospheres	OK	OK	NO	NO	NO
WR 100/200 or WATER RESIST 100/200	WATER RESIST(ANT) 10/20 bar or WATER RESIST (ANT)	Water-resistant to 10/20 atmospheres	OK	OK	OK	NO	NO

* WATER RESIST(ANT) xx bar may also be indicated as W.R. xx bar.

CAUTION

- Be sure to use the watch with the crown pressed in (normal position). If your watch has a screw-type crown, be sure to tighten the crown completely.
- Do NOT operate the crown or button with wet fingers or when the watch is wet. Water may enter the watch and compromise water-resistance.
- If the watch is used in seawater, rinse with fresh water afterward and wipe with a dry cloth.
- If moisture has entered the watch, or if the inside of the crystal is fogged up and does not become clear within a day, immediately take the watch to your dealer or Citizen Service Center for repair. Leaving the watch in such a state will allow corrosion to form inside.
- If seawater enters the watch, place the watch in a box or plastic bag and immediately take it in for repair. Otherwise, pressure inside the watch will increase, and parts (crystal, crown, buttons, etc.) may come off.

CAUTION **Keep Your Watch Clean**

- Leaving dust and dirt deposited between the case and crown may result in difficulty in pulling the crown out. Rotate the crown while in its normal position, from time to time, to loosen dust and dirt and then brush it off.
- Dust and dirt tend to be deposited in gaps in the back of the case or band. Deposited dust and dirt may cause corrosion and soil your clothing. Clean the watch occasionally.

Cleaning the Watch

- Use a soft cloth to wipe off dirt, perspiration and water from the case and crystal.
- Use a soft, dry cloth to wipe off perspiration and dirt from the leather band.
- To clean a metal, plastic, or rubber watchband, wash away dirt with mild soap and water. Use a soft brush to remove dust and dirt jammed in the gaps in the metal band. If your watch is not water-resistant, take it to your dealer.
NOTE: Avoid using solvents (thinner, benzine, etc.), as they may mar the finish.

WARNING **Handling of the Battery**

- Keep the battery out of the reach of small children. If a child swallows the battery, contact a physician immediately.

CAUTION **Replacing the Battery**

- For replacement of the battery, take your watch to your dealer or Citizen Service Center.
- Replace the battery as soon as possible if the service life of the battery has expired. Leaving a depleted battery in the watch may result in leakage, which can damage the watch severely.

CAUTION **Operating Environment**

- Use the watch within the operating-temperature range specified in the instruction manual.

Using the watch where temperatures are outside the specified range, may result in deterioration of functions or even stoppage of the watch.

- Do NOT use the watch in places where it is exposed to high temperature, such as in a sauna.
Doing so may result in a skin burn.
- Do NOT leave the watch in a place where it is exposed to high temperature, such as the glove compartment or dash-board of a car.
Doing so may result in deterioration of the watch, such as deformation of plastic parts.
- Do NOT place the watch close to a magnet.
Timekeeping will become inaccurate if you place the watch close to magnetic health equipment such as a magnetic necklace or a magnetic latch of a refrigerator door or handbag clasp or the earphone of a mobile phone. If this has occurred, move the watch away from the magnet and reset the time.
- Do NOT place the watch close to household appliances that generate static electricity.
Timekeeping may become inaccurate if the watch is exposed to strong static electricity, such as is emitted from a TV screen.
- Do NOT subject the watch to a strong shock such as dropping it onto a hard floor.
- Avoid using the watch in an environment where it may be exposed to chemicals or corrosive gases.
If solvents, such as thinner and benzine, or substances containing such solvents come in contact with the watch, discoloration, melting, cracking, etc. may result. If the watch comes in contact with mercury used in thermometers, the case, band or other parts may become discolored.

16. Specifications

1. Caliber No.: U040
2. Type: Combination quartz watch
3. Accuracy: Within ± 20 seconds/month
(Within a normal temperature range of $+5^{\circ}\text{C}$ to $+35^{\circ}\text{C}$ (41°F to 95°F when worn.)
4. Operating Temperature Range : 0°C to $+55^{\circ}\text{C}$ (32°F to 131°F)
5. Display Functions
 - Analog: • Hours, Minutes, Seconds (3 hands)
 - Digital: • Time: Hours, Minutes, Seconds, City name, Time difference from UTC
 - Calendar: Month, Date, Day, City name, Year (only at the time of adjustment), Time difference from UTC
 - Alarm: Hours, Minutes, On or OF (OFF), City name, Time difference from UTC
 - Chronograph: Hours, Minutes, Seconds, 1/100 seconds, Time difference from UTC, Split Time (24-hour measurement)

- Timer: Minutes, Seconds, Setting time (60-minute measurement), Time difference from UTC
 - Zone Set: Display of city names/non-display setting, summer time setting
6. Additional Functions:
- World time (Time and Calendar display of UTC and 30 cities in the world)
 - EL Light Function
 - Low Battery Warning Function
7. Battery: Battery No.: 280-207, Battery Code: CR2012
8. Battery Life: Approx. 2 years. (Based on assumed use of Alarm 1 sound: 15 seconds/day, Alarm 2 sound: 15 seconds/2 days, Timer time-up sound: 5 seconds/day, EL Light: 3 seconds/day and Chronograph: 24-hour/week)
- These specifications are subject to change, for product improvement, without prior notice.