

***TECHNICAL  
INFORMATION***

---

[ManualsLib.com](http://ManualsLib.com)

**CITIZEN QUARTZ**

**Cal. No. 14※※※**

 **CITIZEN**

## § 1. OUTLINE



This is an analog-type quartz crystal watch (with center second) for gentlemen, which has been born as the fruit of the Citizen's technical superbness along with an economical price.

Like the digital-type watches, the analog watches also have the rapid-growing competitions among them in terms of the prices. And thus the demand is expected largely for the development of new types of analog watches with the high accuracy of the quartz crystal oscillation still maintained.

In this connection, the Citizen's longest life time of about eight years has been realized for the watch power cell. In addition, the using variation is attained based on the functions of Cal. No. 1400A featuring the date/day display, which was a big target to be attained through the designing stage of the watch.

For the appearance, design or structure, the setting stem is positioned close to the dial in order to secure the large chamfering for the case back. And the coin-shaped lithium cell will enhance the good fitting of the watch onto the user's arm.

ManualsLib.com

## § 2. FEATURES

### 1) Power cell life of about eight years

The life time of the power cell has been increased up to about eight years through reduction of the power consumption. This is due to the application of the 3V-group lithium cell plus the load compensating circuit (for automatic control of the output).

Also the power saving switch functions at the hand setting position of the crown.

### 2) The trimmer condenser is omitted since the DFC (Digital Frequency Control) is applied via the logic within the IC.

The time can be controlled on the market in three steps (+15 sec./month, -15 sec./month and -30 sec./month) by cutting off two pieces of controlling patterns. This control terminal is provided independently from that which is used for correction at the factory.

For measurement of the time rate, the "MEASURE TIME" must be set to "10 sec." or its integer-fold value because the signal controlling the frequency comes with every 10 seconds. Thus the correct measurements could be obtained at the measuring unit time other than those mentioned above.

### 3) Power cell life indicator

The normal 1-second step movement of the second hand changes to the 2-second step movement when the output voltage of the power cell drops. This change indicates the replacement of the power cells.

### 4) The composite material is used for the plate complete to realize the light-weight movement as well as the low-cost production of the watch.

## § 3. SPECIFICATIONS

Caliber No.	1400A-02	1410A-02	1430A-02
Movement Size	24mm x 24.6mm x 26mm $\phi$		
Thickness	4.58mm	←	4.53mm
Thickness at power cell part	4.75mm	←	4.53mm
Frequency	32,768Hz		
Accuracy	$\pm 15$ sec./month at normal temperature		
Effective temperature range	$-10^{\circ}\text{C} \sim +60^{\circ}\text{C}$ ( $14^{\circ}\text{F} \sim 140^{\circ}\text{F}$ )		
Converter	Bipolar step motor		
Integrated circuit	C/MOS-LSI (1 unit)		
Time adjustment	By DFC via logic within LC circuit in three steps (+15 sec./month, -15 sec./month and -30 sec./month)		
Additional functions	Date display (EC)	←	×
	Power cell indicator	←	←
	Power saving switch	←	←
Power cell (Lithium cell)	Parts No. : 280-202 Cell code : BR2016 Li/(CF)n Nominal voltage : 3V Capacity : 65mAH Size : 20.0mm $\phi$ x 1.6mm Life time : About 8 years		

## § 4. HANDLING METHOD

The time can be set for this watch in the same way as other analog watches with center seconds. The crown is pulled out two steps to set the time, and then the date/day is set with the crown at the first click-stop position.

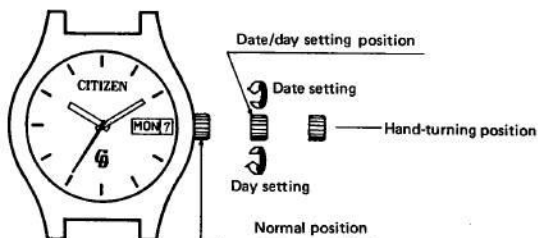

§ 5. STRUCTURE OF MOVEMENT

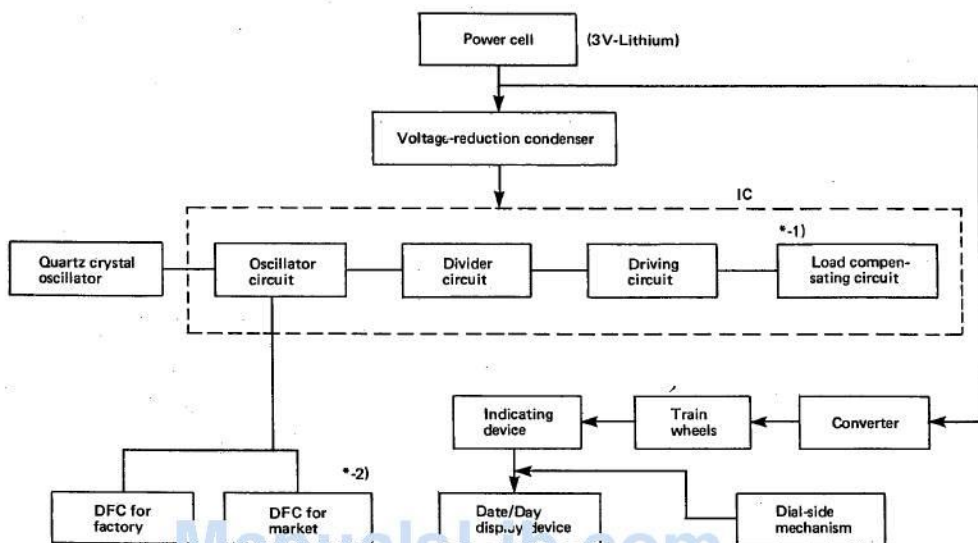

\*-1) Load compensating circuit

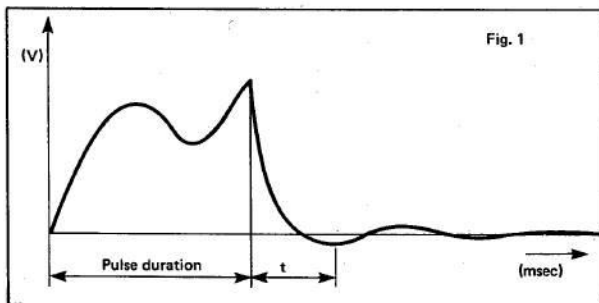

For operation of the step motor, the stoppage (no turning of rotor) is detected by the phase or the height of the voltage which is induced at the coil after the end of application of the driving pulse.

The driving of the rotor is attenuated with the overrunning kept by the inertia and even after the end of application of the pulse as shown in Fig. 1.

And how the rotor operated is detected by the phase and the

voltage height in time "t" after the end of application of the pulse. If no operation was given, another signal (driving pulse) is emitted immediately for compensation.

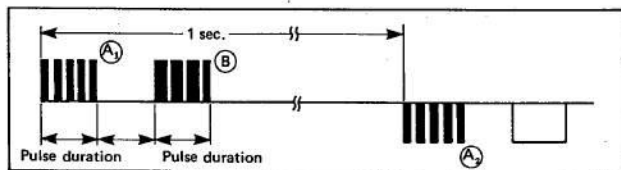
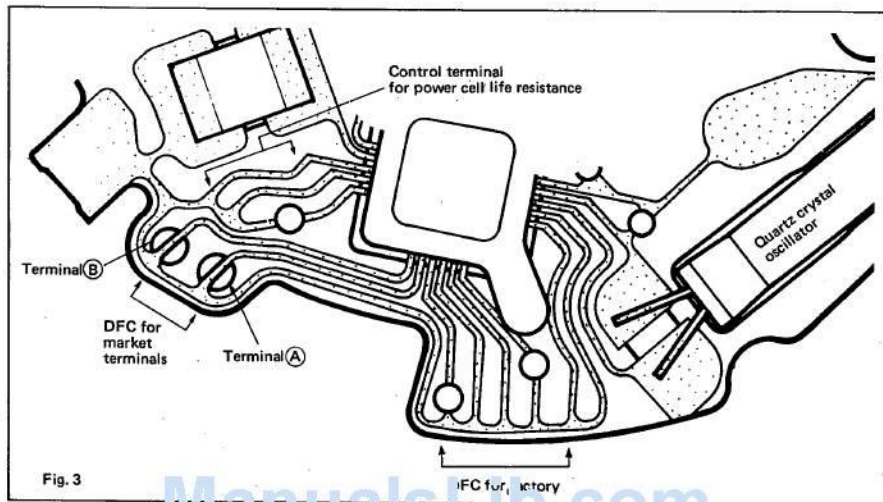

Fig. 2

Normally, pulse (A<sub>1</sub>) is delivered from the circuit, and then signal (A<sub>2</sub>) is delivered after one second. In case the rotor has no operation with the signal of (A<sub>1</sub>), another signal (B) arrives immediately as mentioned above to operate the rotor.

The signal of (A<sub>1</sub>) features the different thin-out factor from the signal of (B), which means the saving of power consumption.

## \*2) DFC for market



The back-side wiring pattern is shown in Fig. 3 for the unit of electronic circuit.

With the DFC (Digital Frequency Control), the waveform of the division step is increased or decreased logically to give the control to the frequency.

On the contrary, the conventional system by the trimmer condenser controls the frequency by varying the oscillation conditions via the capacity change of the condenser.

In Fig. 3,  $Df_1$  ~  $Df_5$  show the DFC for factory and are used for control exclusively at the factory and not on the market.

The DFC for market comprises two terminals A and B.

The time rate adjustment is possible in the following three steps.

Cut-off of terminal A: Control to present time rate +15 sec./month  
 Cut-off of terminal B: Control to present time rate -15 sec./month  
 Cut-off of terminals A and B: Control to present time rate -30 sec./month

With application of the DFC, the aging of only quartz crystal oscillator has to be put into consideration although both the quartz crystal oscillator and the trimmer condenser must be considered for the aging. And the aging characteristics of the quartz crystal oscillator generally features the shift toward the plus direction. Thus the terminal of -30 sec./month is set up.

The frequency control is carried out within the circuit by the signal and every 10 seconds, and accordingly the "MEASURE TIME" must be set to "10 sec." or its integer-fold value for measurement of the time rate.

## §6. COMPOSITE MATERIAL

This caliber uses the composite material for the plate. This material is developed in USA and called PPS (Poly-phenylene Sulfide). The PPS resin is reinforced with the glass fiber via the filler, thus obtaining the new heat-resistant engineering plastics.

For actual application of the PPS material, the full-scale designing conception had to be put into consideration at the early state of development. Thus various contrivances have been given in order to realize the thin-gage structure as well as high intensity.

For instance, the metal auxiliary material is provided as shown in Fig. 4 in order to maintain the fixing power for the central pipe.

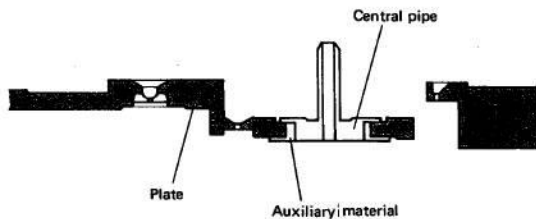

Fig. 4

### • Features of PPS resin

- The high heat resistance is ensured with the fusing temperature of 290°C and the decomposition starting temperature of 400°C each.
- Featuring the high chemical resistance approximate to that of the fluororesin, the PPS resin is never affected by the acid, the inorganic salt and the organic solvent each. However, the PPS resin is affected by the chemicals featuring the high oxidizing force such as the nitric acid or the like, and the degree of affection can be ignored in terms of the actual use.
- The PPS resin is hard to burn although it is put close to the fire, and does not drip even if it burns. Furthermore, the burning PPS resin is extinguished immediately after it is put away from the flame. Thus the PPS resin features the fire resistance.
- The PPS resin features the excellent mechanical performance in particular among the groups of the thermoplastic resin.

### • Washing resistance

This caliber uses the DURACON (polyacetal resin) for the date dial, the day star wheel, the date dial driving wheel and then the ZYTEL (polyamide resin) for the hour wheel each.

The DURACON is used for the hour wheel of Cal. No. 85\*\*\*, and the ZYTEL features the increased mechanical strength.

For the washing of the plate complete and others, the trichloroethane, the Freon, the Benzine, the ligroin, the benzine etc. are used. After washing, the parts are exposed into the cool air (less than at 50°C and 10 minutes) for drying.

## §7. DISASSEMBLY AND ASSEMBLY

Disassembling procedure: ① ~ ②④

Assembling procedure: ②④ ~ ①

### 1) Dial side

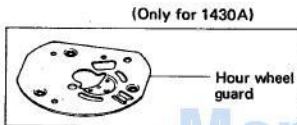

#### Lubrication marks

⊗ Synt-A-Lube oil

⊕ Synta V-Lube oil

⊙ Citizen watch oil CH-1

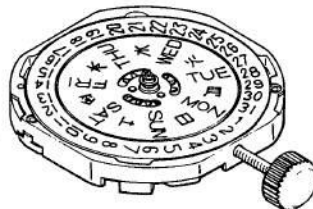
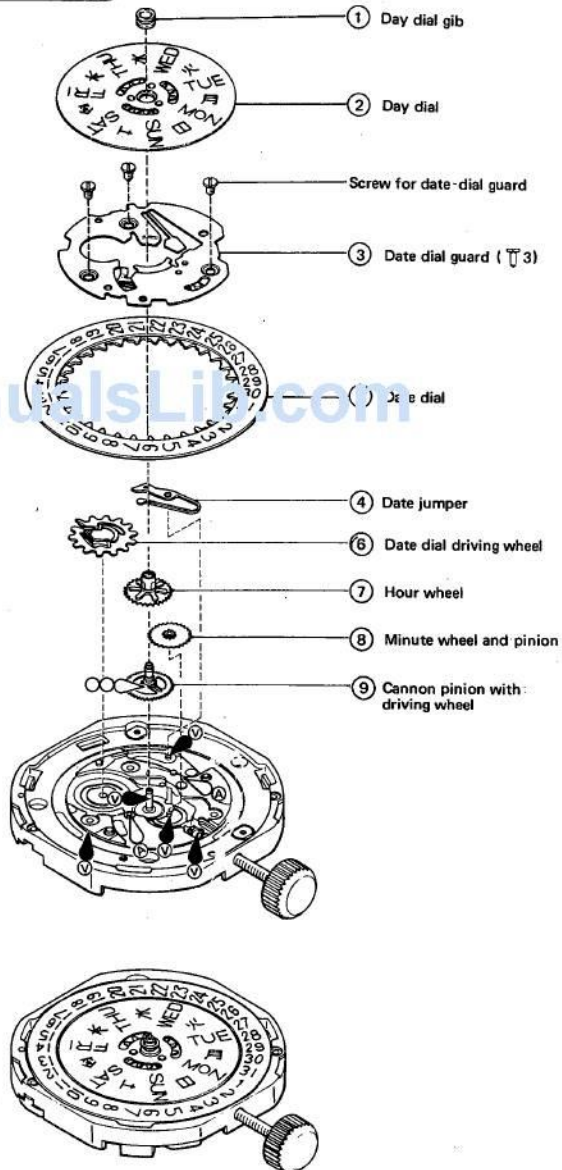

2) Power cell side

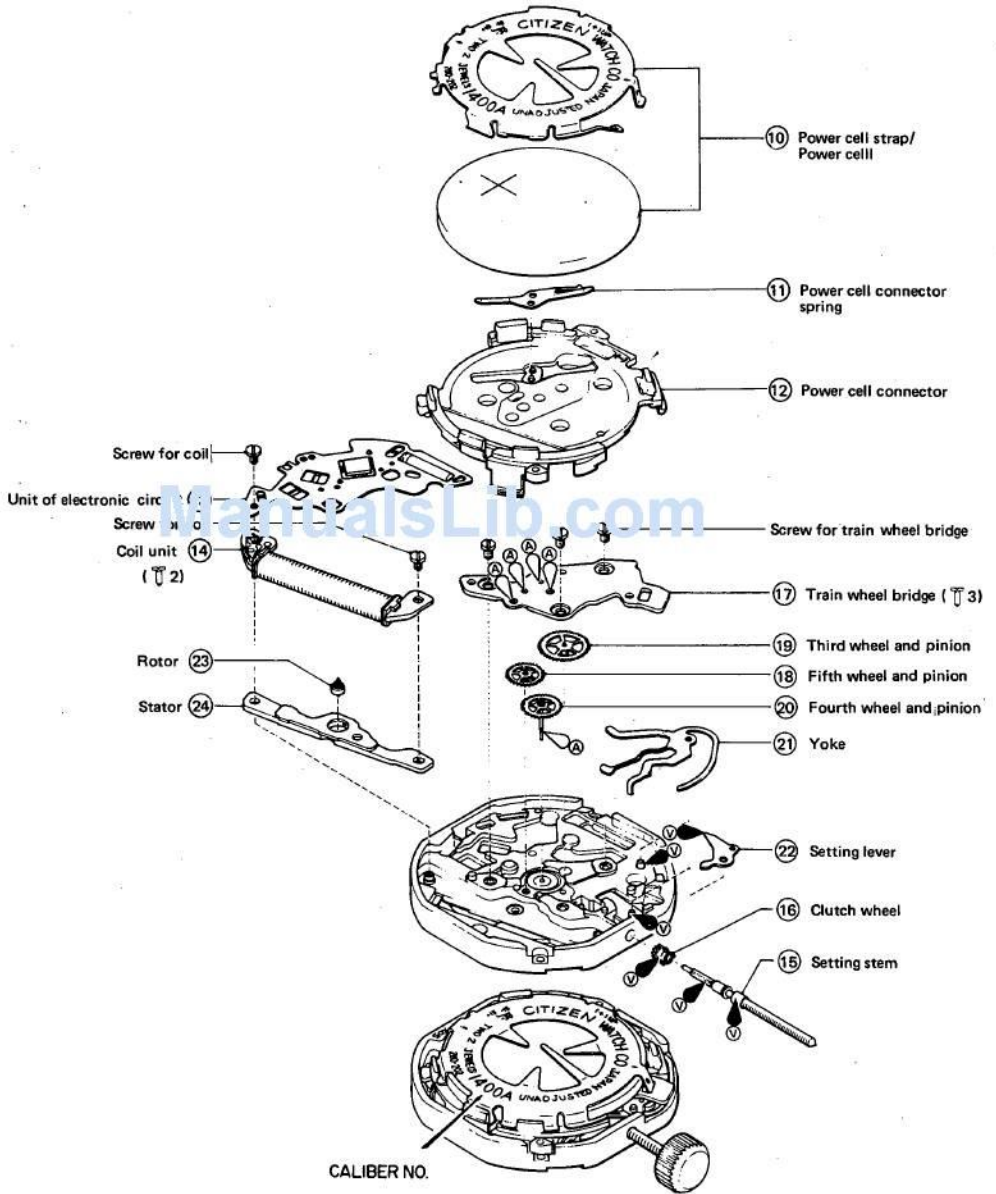

### 3) Notes on disassembly/assembly

#### (1) Power cell

As shown in Figs. 5 and 6, the power cell is set into the movement after being set to the power cell strap.

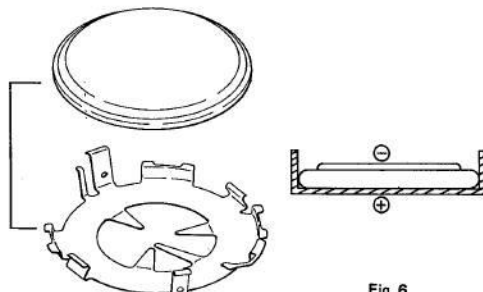

Fig. 5

Fig. 6

#### (2) Attachment/detachment of setting stem and how to remove power cell strap



Fig. 7

As shown in Fig. 7, hole part A of the setting lever is seen by pushing in the crown. Then the area of part A is pressed to remove the setting stem.

When removing the power cell strap, the two hole parts provided at part B are pressed alternately with the tweezers or the like to push up the strap. In this case, the power cell is also removed.

#### (3) How to remove power cell connector

As shown in Fig. 8, the power cell connector is removed by pushing points C alternately and then lifting up the connector.

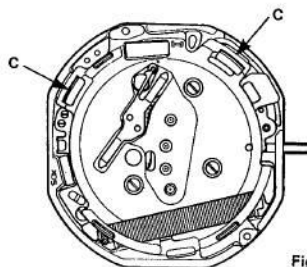

Fig. 8

#### (4) Fixing method of dial

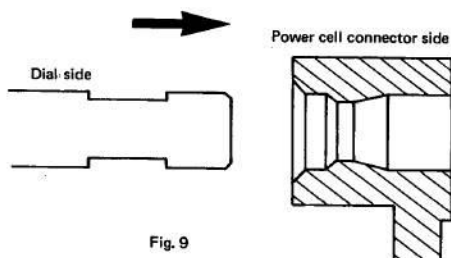

Fig. 9

The two legs of the dial are fitted to the hole parts of the power cell connector after passing through the holes of the plate to be held. (Fig. 9)

The dial is removed by prying open the area between the plate and the dial with the driver or the like and alternately from the 1-o'clock and 7-o'clock directions. The recess for prying is provided to the plate.

**(5) Handling of day dial gib**

The shape of the day dial gib features the double-flange type. The tweezers are put between the both flanges, and then the dial gib is lifted up. (Fig. 10)

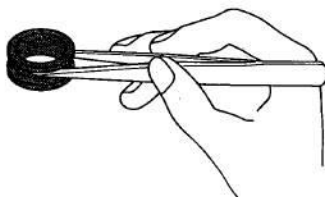
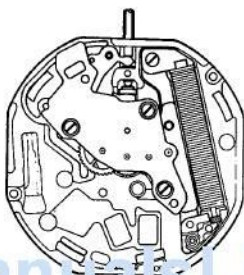
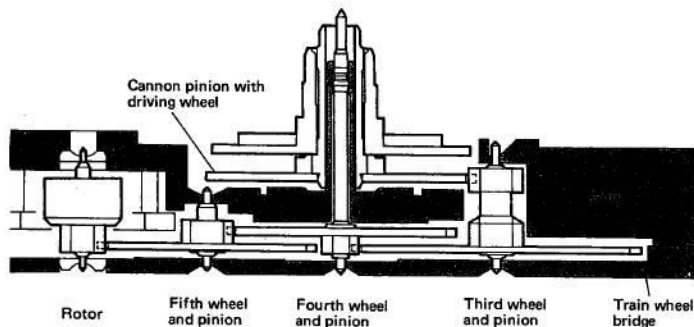

Fig. 10

**(6) Train wheels**

When assembling the train wheels, the tip's bent part of the yoke touches the lower face of the third wheel and pinion. This is caused by the fact that the tip part of the yoke touches the reset terminal of the lower face of the unit of electronic circuit with the crown pulled out two steps. And this problem can be solved when the unit of electronic circuit is assembled.

(Be careful of the shift between the unit of electronic circuit and the projection of the plate when assembling the electronic circuit.)

**(7) Cross-section of train wheels assembled**

The jewels are used only at the two areas, i.e., the upper and lower hole jewels of the rotor. The lower hole jewel of the rotor is fixed to the plate and thus impossible to be adjusted. Accordingly, the adjustment of the hole jewel is given at the side of the train wheel bridge.

**(8) Screws**

The screws of this caliber feature the self-tap system (in which the female screw is produced by the screw itself), and accordingly have different screw pitches from those of other watches. Thus the screws of this watch cannot be used in common with other screws although the diameters of the screws are identical to each other. The self-tap system of the screw is applied to this caliber for the first time in Citizen.

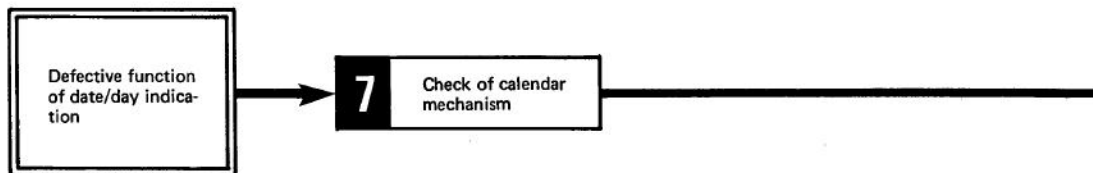
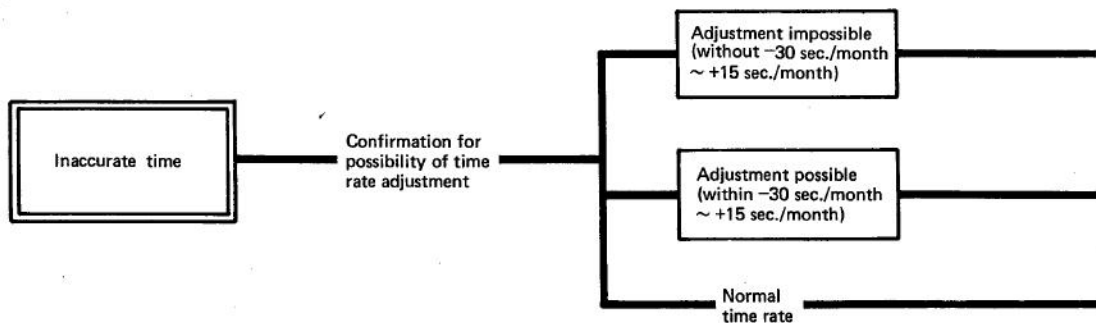
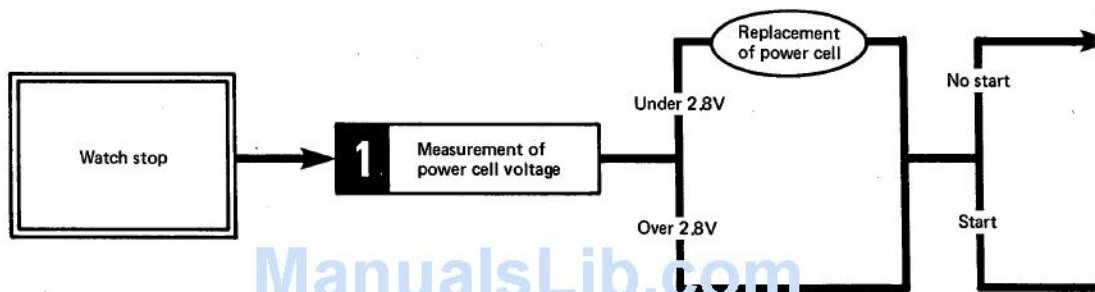

## § 8. TROUBLESHOOTING AND ADJUSTMENT

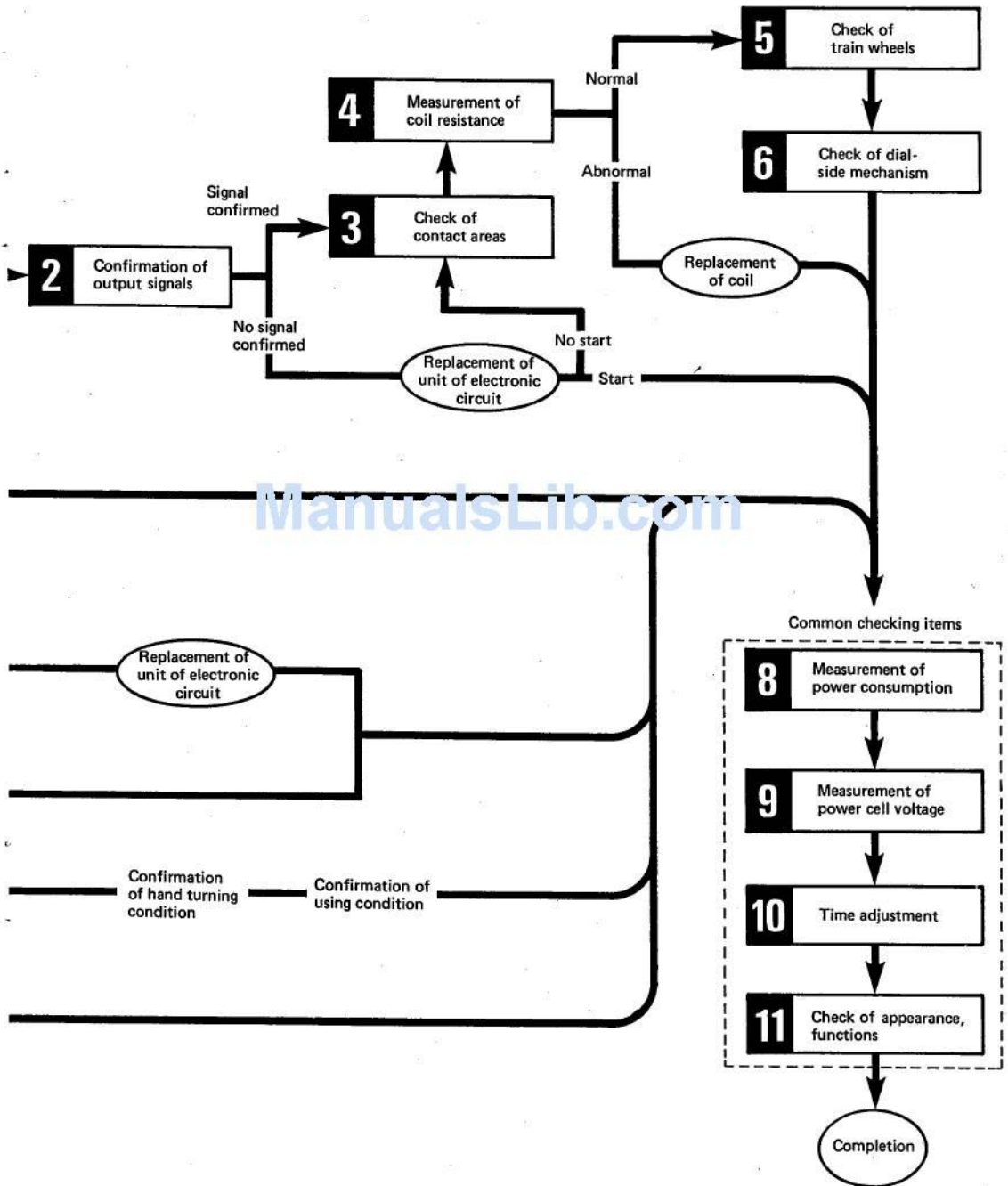

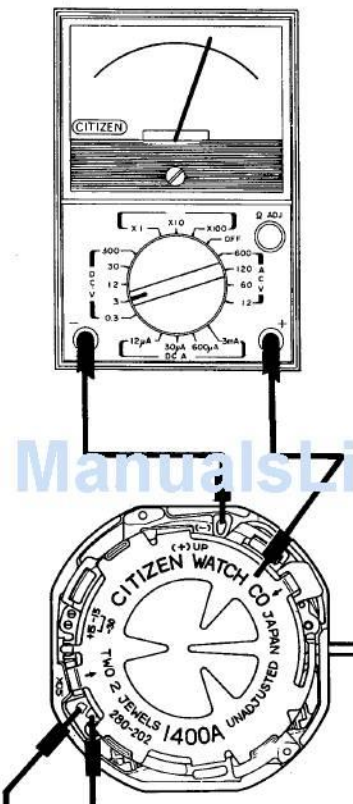
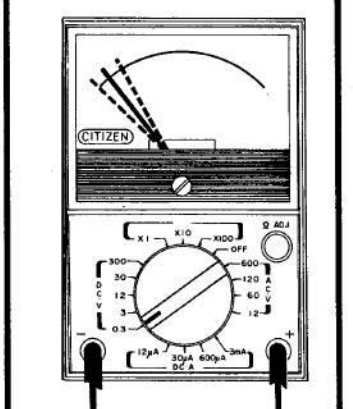

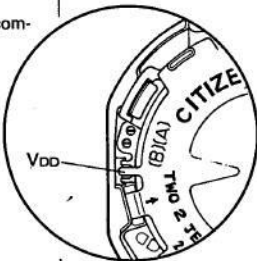
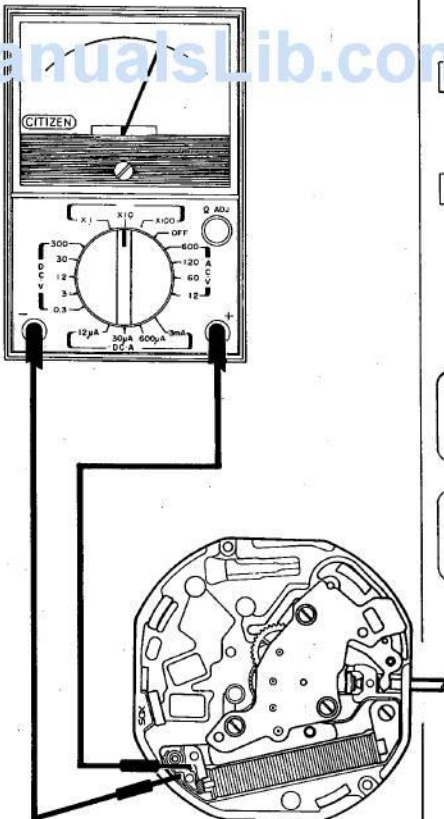

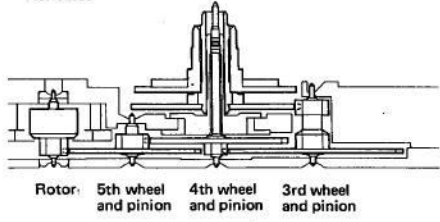
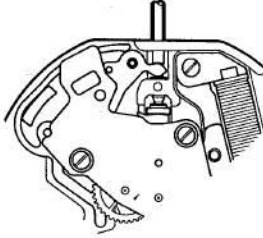
Checking items	How to check	Result and treatment
<p><b>1</b> Measurement of power cell voltage</p>		<p><b>Over 2.8 V</b>          → Normal</p> <p><b>Under 2.8V</b>          → Replacement of power cell</p> <div style="border: 1px solid black; padding: 5px; margin-top: 10px;"> <p>The new power cell may sometimes exceed the output of over 3V. In such case, the measurement is carried out in the 12V-range.</p> </div>
<p><b>2</b> Confirmation of output signals</p>		<div style="border: 1px solid black; padding: 5px; margin-bottom: 10px;"> <p>The output signals are normal if the tester pointer goes and comes back every second and centering on 0.</p> </div> <p>Any defect confirmed          → Replacement of unit of electronic circuit</p>

Checking items	How to check	Result and treatment
<p><b>3</b> Check of contact areas</p>	<p>The following points are checked.</p> <ol style="list-style-type: none"> <li>1) Whether some foreign matter is mixed into the contact area between the coil terminal (both ends) and the unit of electronic circuit.</li> <li>2) Whether some foreign matter is mixed into the ⊕ contact area between the power cell strap and the unit of electronic circuit.</li> <li>3) Whether the power cell connector is set in completely.</li> </ol>	<p>Foreign matters mixed</p> <p>→ To be removed away</p> 
<p><b>4</b> Measurement of coil resistance</p>		<p>Measurements of coil resistance:</p> <p><b>2. ~ 3.0kΩ</b></p> <p>→ Normal</p> <p>Measurements outside</p> <p><b>2.5 ~ 3.0kΩ</b></p> <p>→ Replacement of coil unit</p> <p>The above reference coil resistance is set based on Cal. Nos. 1400A and 1430A.</p> <p>Before measurement of the coil resistance, the adjustment must be given to the ΩΩ of the tester.</p>

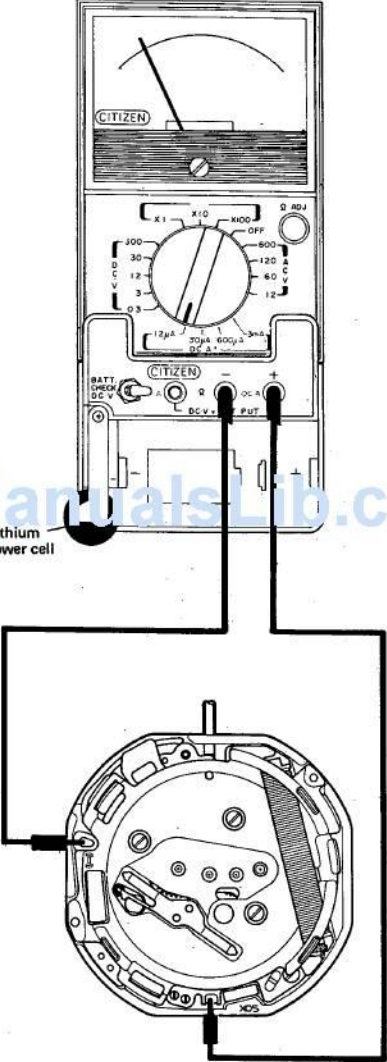
Checking items	How to check	Result and treatment
<p>5 Check of train wheels</p>	<p>1) This caliber applies the direct-hole system except for the upper and lower hole jewels of the rotor. Accordingly, the clearance adjustment can be given only to the rotor by shifting the hole jewels at the side of the train wheel bridge.</p> <p>2) The lubricating condition is checked.</p> <p>3) Whether the dust or stains attach to the train wheels.</p>  <p>Rotor    5th wheel and pinion    4th wheel and pinion    3rd wheel and pinion</p>	<p>No clearance secured for 3rd, 4th and 5th wheels          → Replacement of each wheel or train wheel bridge</p> <p>No oil applied          → Supply of Synt-A-Lube oil</p> <p>Dust attached          → To be cleared away</p> <p>Stains attached          → To be washed away</p>
<p>6 Check of dial-side mechanism</p>	<p>1) Whether the cannon pinion is secured when the hands are turned.</p>  <p>2) Whether the hour wheel has some malformation.</p>	<p>Considerably heavy          → Supply of CH-1 oil to cannon pinion with driving wheel</p> <p>Considerably light          → Replacement of cannon pinion with driving wheel</p> <p>Malformation of hour wheel          → Replacement of hour wheel</p>
<p>7 Check of calendar mechanism</p>	<p>The following points are checked.</p> <p>1) Whether the date dial guard has some warp or bend.</p> <p>2) Whether the date dial driving wheel has some malformation.</p> <p>3) Whether the quick setting is possible for the date with the clockwise turn of the crown and for the day with the counterclock turn of the crown respectively. (1400A)</p> 	<p>Warp or bend of dial guard          → Replacement of dial guard</p> <p>Malformation of driving wheel          → Replacement of driving wheel</p>

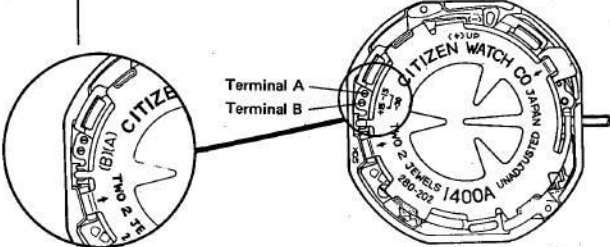
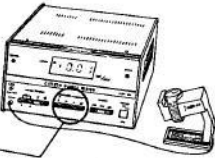
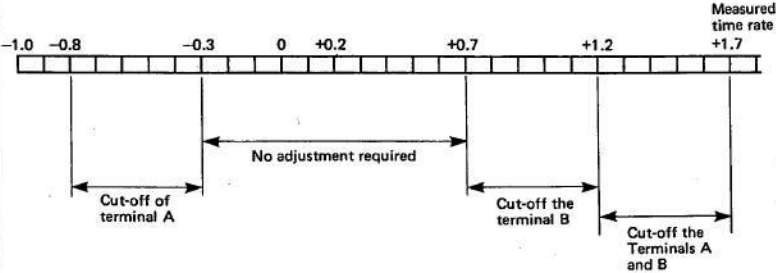
Checking items	How to check	Result and treatment
<p>8 Measurement of power consumption</p>	 <p>Lithium power cell</p>	<p><b>Under 1.4<math>\mu</math>A</b></p> <p>→ Normal</p> <p><b>Over 1.4<math>\mu</math>A</b></p> <p>→ Check of lubricating condition of train wheels</p> <p>And then:</p> <p>Normal lubrication</p> <p>→ Replacement of unit of electronic circuit</p> <p>Abnormal lubrication</p> <p>→ Measurement of power consumption after washing and lubrication</p>
<p>9 Measurement of power cell voltage</p>	<p>Refer to <b>1</b>.</p>	

Checking items	How to check	Result and treatment
<p>10 Time adjustment</p>	<p>The time can be adjusted in the range of <math>-30 \text{ sec.} \sim +15 \text{ sec.}</math> by cutting off the pattern of the unit of electronic circuit.</p>  <p>As shown in the above diagram of the movement, the upper and lower parts are defined as terminals A and B when viewed from the power cell side with the crown put right.</p> <p>Now with cut-off of terminal A, the time gains by about <math>0.5 \text{ sec./day}</math> in terms of the time rate value; while the time loses by about <math>0.5 \text{ sec./day}</math> when terminal B is cut off respectively. And if both terminals A and B are cut off, the time loses about one second per day. This value is converted into the loss of 30 sec. per month.</p> <p>The two different markings are given onto the power cell strap, part of which is indicated in figures. In any case the time rate must be given based on the fact that the time gains by about <math>0.5 \text{ sec./day}</math> with cut-off of terminal A.</p> <p>Notes on measurement of time rate: As this caliber applies the DFC system, the "MEASURE TIME" must be set to "10 sec." or its integer-fold value.</p> <p>Please refer to the following description when the adjustment is given to the time rate.</p>   <p>Time rate measurements of watch:</p> <ol style="list-style-type: none"> <li><math>-0.8 \sim -0.3 \text{ sec./day}</math> → Cut-off of terminal A</li> <li><math>-0.3 \sim +0.7 \text{ sec./day}</math> → No adjustment required for time rate</li> <li><math>+0.7 \sim +1.2 \text{ sec./day}</math> → Cut-off of terminal B</li> <li><math>+1.2 \sim +1.7 \text{ sec./day}</math> → Cut-off of terminals A and B</li> <li>Slower than <math>-0.8 \text{ sec./day}</math> and faster than <math>+1.7 \text{ sec./day}</math> → Replacement of unit of electronic circuit</li> </ol>	

Checking items	How to check	Result and treatment
11 Check of appearance, functions	 <p>The following points are checked.</p> <ol style="list-style-type: none"><li>1) Whether the dust is stuck onto the upper surface of the dial as well as the lower surface of the glass each.</li><li>2) Make sure that the calendar and other mechanisms function in the correct way.</li><li>3) Make sure that the second hand stops its movement when the crown is pulled out two steps and then starts again in one second after being pushed in.</li></ol>	