

# ***TECHNICAL INFORMATION***

---

**CITIZEN QUARTZ**  
ManualsLib.com

**Cal. No. F910**

## Contents

<b>§1. FEATURES</b> .....	1
<b>§2. BEFORE USING</b> .....	1
<b>§3. SPECIFICATIONS</b> .....	2
<b>§4. FOR PROPER POWER GENERATION</b> .....	2
<b>§5. HOW TO OPEN CASE BACK</b> .....	4
<b>§6. SETTING THE TIME AND CALENDAR</b> .....	5
<b>§7. CHARACTERISTIC FUNCTIONS</b> .....	6
<b>§8. WARNING FUNCTIONS</b> .....	7
<b>§9. SECONDARY BATTERY</b> .....	7
<b>§10. PRECAUTIONS FOR DISASSEMBLY AND ASSEMBLY</b> .....	8
<b>§11. DISASSEMBLY AND ASSEMBLY OF MOVEMENT</b> .....	12
<b>§12. TROUBLESHOOTING AND ADJUSTMENT</b> .....	14

[ManualsLib.com](http://ManualsLib.com)

## §1. FEATURES

This watch is an analog quartz watch equipped with a thermoelectric generation function that drives the watch by converting body heat (heat energy), produced when wearing the watch on the wrist, into electrical energy.

Power is generated when the watch is worn on the wrist and the second hand is moving at 1-second intervals. When the watch is removed from the wrist, the second hand moves at 10-second intervals, indicating that power is not being generated.

When fully charged, the watch will run continuously for about six months without charging. To fully charge the watch after it has stopped due to insufficient charge requires about 15 days (continuous charging). To ensure optimal usefulness, make sure that the watch is always sufficiently charged.

This watch uses a secondary battery for storing the electrical energy that is generated. This secondary battery is completely free of mercury or other hazardous substances. It does not have to be replaced periodically in the manner of conventional watch batteries since it is able to be charged and discharged repeatedly.

## §2. BEFORE USING

### **Please Make Sure to Fully Charge the Watch Before Use**

Check to make sure that the second hand of the watch is moving in 1-second intervals when worn on the wrist.

If it is moving in 2-second intervals, this means that the watch is not sufficiently charged.

Charge the watch by wearing the watch so that the back of the watch is in direct contact with your wrist at all times until the second hand returns to 1-second interval movement. This watch is provided with an overcharging prevention function that eliminates any worries that the watch may be overcharged no matter how long it is charged.

When the second hand is moving in 2-second hitch movement, this indicates that the watch has stopped running as a result of being insufficiently charged. When this happens, fully charge the watch and reset the time before further use.

### §3. SPECIFICATIONS

Caliber NO.	F910
Type	Thermoelectric power generation quartz watch
Movement size (mm)	ø23.7 × 5.48t
Accuracy (At normal temperature)	±15 sec/month (5°C~35°C/41°F~95°F)
IC	1 unit of C/MOS-LSI
Operating temperature	-10°C~+60°C (14°F~140°F)
Converter	Bipolar step motor
Time adjustment	No adjustment terminal for use in market
Measurement gate	10 sec.
Display functions	Time (Hours, Minutes, Seconds)
	Calendar
Additional functions	Thermoelectric generation function
	Insufficient recharging warning function
	Time setting warning function
	Overcharging prevention function
Continuous operating time	Fully charged to stopping: Approx. 6 month
	2-second interval movement to stopping: Approx. 11 days
Secondary battery	2 × 3.5

### §4. FOR PROPER POWER GENERATION

#### [Power Generation Mechanism]

When this watch is worn on the wrist, body heat from contact with the skin will heat up the back cover of the watch. This heat will be released into the air from the surface of the watch, and the temperature difference between the back cover and the watch surface will drive a thermoelectric generation device that generates electric energy. Power generation performance varies considerably depending on air temperature, individual differences in body temperature and the manner in which the watch is worn. The standard usage environment of this watch is defined as wearing the watch so that the back cover is in direct contact with the wrist at an air temperature of about 25°C (77°F) and body temperature (surface temperature on the wrist) of 32°C (89.6°F).

Power generation performance increases as the temperature difference between the back cover and watch surface becomes larger, and decreases as the temperature difference becomes smaller. Power is no longer generated when the surface temperature of the watch and the temperature of the back cover are equal or when the surface temperature exceeds that of the back cover. The watch is unable to generate sufficient power if the surface of the watch is covered with clothing or other objects. It is recommended to wear the watch so as to release the heat of the watch surface as much as possible.



### [Principle of power generation]

If two metallic plates of different types are connected to each other and the temperatures at both ends of them are different from each other, a current flows through them. This phenomenon is called "**Seebeck effect**". If there is temperature difference between two parts of a metal, electrons flow from the hotter part to the colder part and a "thermoelectromotive force" is generated. The thermogenerator block in the movement is a semiconductor compound mainly consisting of "BiTe (Bismuth Telluride)" which generates a large thermoelectromotive force. If the temperature of the case back is different from that of the watch surface, the thermoelectromotive force which is electric energy is generated and a current flows. This energy is stored in the secondary battery and used to drive the watch.

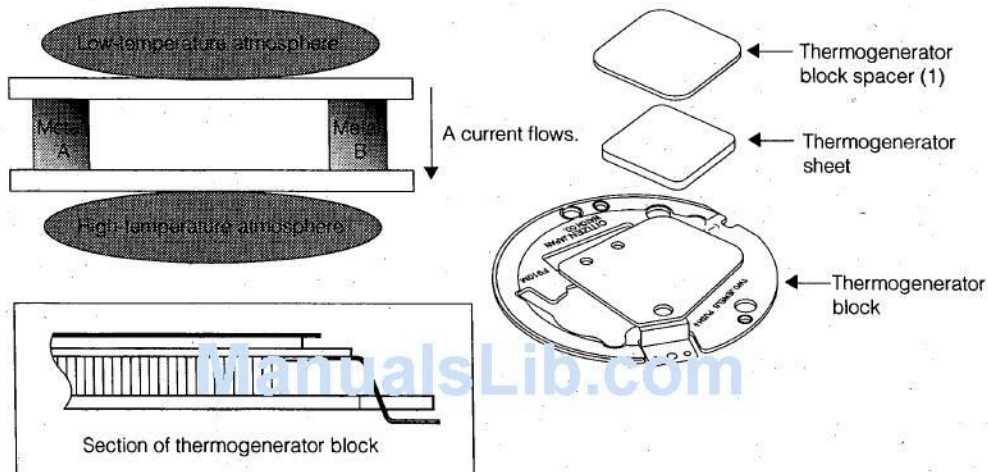

### [Distinguishing Between Power Generating and Non-Power Generating Model]

When power generation has stopped as a result of removing the watch from the wrist, the second hand moves at 10-second intervals indicating that power is not being generated. When power generation is resumed by putting the watch on your wrist or warming the back cover with your fingers, the second hand returns to 1-second interval movement.

### [General Reference for Charging Times]

Wear the watch on the wrist for at least 5 hours per day to ensure one day's worth of charging at the time of 1-second interval movement. If the watch stops due to insufficient charge, full charge using the 1-second interval movement will take about 50 days provided that the watch is worn for 8 hours per day. However, make sure to attach the watch to the wrist in the correct manner, as the way the watch is attached will greatly affect the time required for charging. It is recommended to wear the watch daily to store an ample amount of electrical energy and increase the amount of charge retained by the watch.

### [Hints for Effective Power Generation]

- Wear the watch so that the back cover is firmly against your wrist.
- Wear the watch so that heat is released from the watch surface.
- Do not allow the watch to be covered up with clothing (sleeves, gloves, winter gear, etc.).
- Try to wear the watch for long periods of time.
- Allowing air to blow over the upper surface of the watch while wearing it to lower the surface temperature makes it easier for the watch to generate power.

## CAUTION

### [Precautions During Power Generation]

Warming the entire watch dissipates the temperature difference between the back cover and watch surface, thereby preventing power from being generated.

- Do not warm the surface of the watch by touching with your hand.
- Do not warm the watch with a heating or cooking appliance.
- Do not attempt to warm the watch with an open flame from a gas range, lighter or other heating device.
- Do not attempt to warm the watch with hot air from a hair dryer or other appliance.
- Do not warm the watch surface with direct sunlight.
- Leaving the watch in locations of high temperature may cause deterioration of the thermoelectric generation function.
- Do not leave the watch where it becomes high temperature [60°C (140°F) or higher] like on an automobile dashboard.

## §5. HOW TO OPEN CASE BACK

The case back is fixed to the case with 6 "case back screws". To remove the case back, remove the 6 "case back screws". Each case back screw is removed together with the "washer". Take care not to lose the washers.

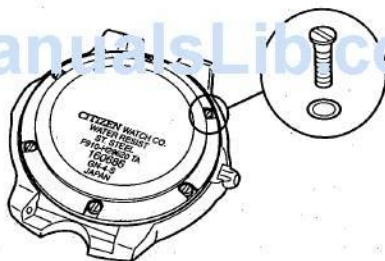

### [How to tighten case back screws]

- Be sure to tighten the six case back screws securely in the diagonal order.

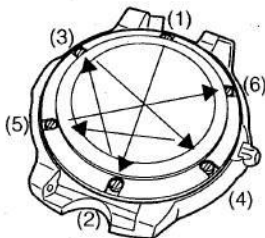

## §6. SETTING THE TIME AND CALENDAR

If the watch has stopped running due to insufficient charging or the second hand is moving at 2-second intervals when setting the time, first return the watch to 1-second interval movement before setting the time by charging with reference to the section entitled, "§4. FOR PROPER POWER GENERATION". If the crown is a screw lock type, the screw should be loosened before the operation. Make sure to tighten the screw again after the settings are made.

### [Setting the Time]

**<When the second hand is moving at 1-second intervals (generating electric power display) / 2-second intervals (insufficient recharging warning display) / 2-second hitch movement (time setting warning display)>**

1. Pull the crown twice to the time correction position when the second hand reaches the 0 second position.
2. Turn the crown to set the time.
  - The date changes at AM 0. Make sure not to mistake AM for PM and vice versa when setting the time.
  - The date indication starts changing from around 9 PM and is completed around 1 AM.
  - A more precise setting of the time can be accomplished by advancing the minute hand 4 to 5 minutes from the correct time and then moving it back to the correct setting.
3. Return the crown to its normal position in synchronization with the telephone time tone. The second hand will start to move and the watch will start ticking away from the correct time.

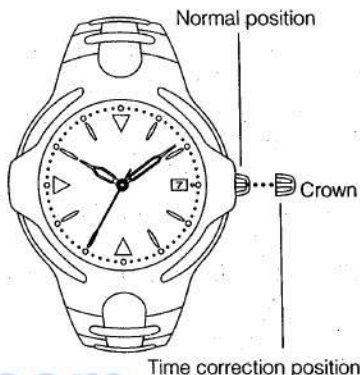

**<When the second hand is moving at 10-second intervals (indicating that power is not being generated)>**

1. Pull the crown twice to the time correction position when the second hand reaches the 0 second position.
2. Turn the crown to set the time.
3. Return the crown to its original position in synchronization with the telephone time tone. The second hand will start to move and the watch will start ticking away from the correct time.

### CAUTION

**<If the stop position of the second hand shifts, and it does not stop at the 0 second position>**

If the crown is pulled out to the time correction position when the second hand is at another position than the 0-second, 10-second, 20-second, 30-second, 40-second or 50-second position, or if the second hand does not stop at the 10-second interval movement stop positions due to the influence of static electricity or physical impacts, perform the following procedure to set the correct time again.

1. Pull the crown twice to the time correction position when the second hand is between 51 and 59 seconds.
2. Push the crown in a normal position. The second hand moves at 1-second intervals for 10 seconds only.
  - In the 10-second interval movement condition (non-power generating condition) only, 1-second interval movement will take place for 10 seconds after the crown is pressed in.

3. Pull the crown twice again to the time correction position when the second hand reaches the 0 second position.

- Refer to <When the second hand is moving at 1-second intervals (generating electric power display) / 2-second intervals (insufficient recharging warning display) / 2-second hitch movement (time setting warning display)>, and reset the time.

#### <Setting the Calendar>

1. Pull the crown once to the calendar correction position.
2. While turning the crown to the left, match with the date of the day.
  - Idle motion will result if the crown is turned to the right.
  - If the date is adjusted while the time indication is between 9 PM and 1 AM, the date may not change even on the following day.
  - This watch employs a 31-day dating system. For months with only 30 days and February, the crown must be operated to correct the date on the first of the following month.
3. Return the crown to the normal position.

## §7. CHARACTERISTIC FUNCTIONS

The display of this watch changes following the activation of the warning functions described below when the watch is insufficiently charged.

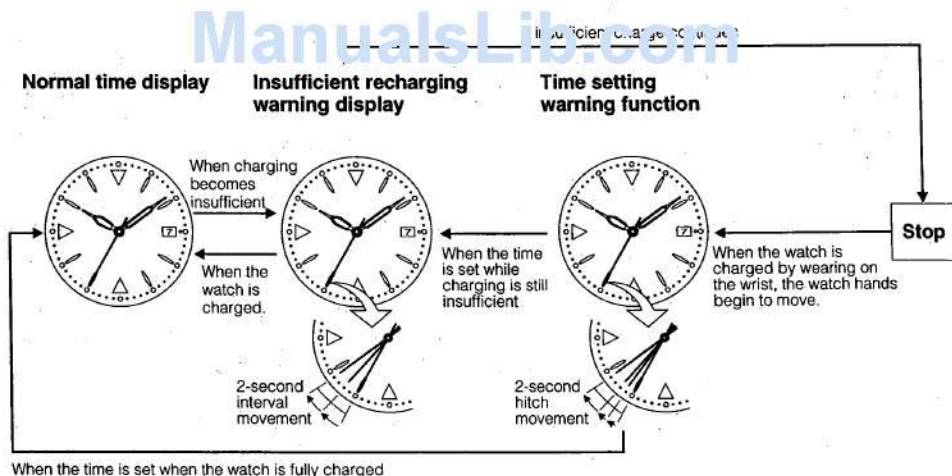

## §8. WARNING FUNCTIONS

The display of this watch changes when the warning functions described below are activated as a result of the watch being insufficiently charged. The watch does not change to 10-second interval movement even if power is not generated while any of these functions are activated.

### [Insufficient Recharging Warning Function]

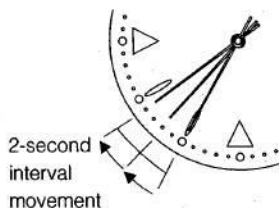

When the second hand is moving at 2-second intervals (moves two gradations at a time every 2 seconds), this indicates that the watch is insufficiently charged. Although the watch continues to run normally at this time, if roughly 11 days elapse after 2-second interval movement has begun, the watch stops running. When this happens, charge the watch by wearing it on your wrist until it returns to normal 1-second interval movement.

If charging is discontinued soon after the watch returns to 1-second interval movement, it will again return to 2-second interval movement several minutes later.

### [Time Setting Warning Function]

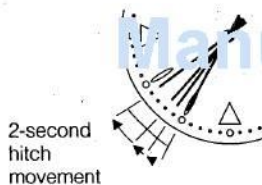

Although the watch hands begin to move when the watch has been recharged after it has stopped as a result of being insufficiently charged; since the time is incorrect, the second hand moves in a 2-second hitch movement (moves irregularly once every 2 seconds) indicating that the time is incorrect.

When this happens, charge the watch by wearing it on your wrist after resetting it to the correct time. When the time is set, 2-second hitch movement is canceled, and the watch returns to the normal time display or the insufficient recharging warning function. In the case of 2-second hitch movement; charge the watch until it returns to 1-second interval movements.

## §9. SECONDARY BATTERY

### WARNING - Handling of the Secondary Battery -

Never attempt to remove the secondary battery from the watch. When the secondary battery must unavoidably be removed, store in a location out of the reach of small children to prevent accidental swallowing. If the secondary battery should happen to be swallowed, please consult a physician immediately and seek medical assistance.

### WARNING - Only Use the Specified Battery -

Never use a battery other than the secondary battery specified for use in this watch. Although the watch is constructed so as not to operate when a different type of battery is installed in the watch, if another type of battery such as a silver battery is forcibly used and the watch should happen to be charged using that battery, there is the risk of the battery rupturing resulting in damage to the watch and personal injury. Always make sure to only use the specified battery when replacing the secondary battery of this watch.

### [When Not Using for a Long Period of Time]

It is recommended to store the watch with the crown pulled out to the time correction position to save on electrical power. This makes it possible to suppress current consumption and extend the duration of watch usage without charging. When using the watch after storing, make sure to first reset the time after fully charging and returning to 1-second interval movement.

## §10. PRECAUTIONS FOR DISASSEMBLY/ASSEMBLY

### [Procedure for taking out movement]

1. Remove the six case back screws and case back.
  - When removing the case back, pry up its rim little by little so that the thermogenerator block will not be damaged.



2. Remove the sheet conduction plate.

Sheet conduction plate

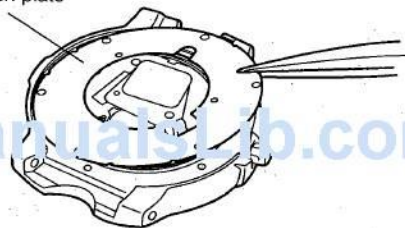

3. Push the setting lever to remove the setting stem.

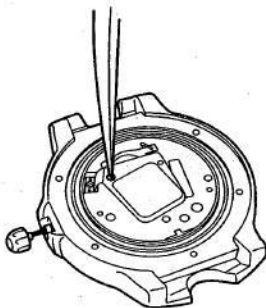

4. Take the movement out of the case.

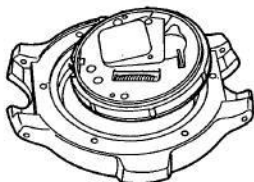

## [Procedure for installing movement and case back]

1. Set the movement with the 6-o'clock side ahead, taking care not to deform the ground spring.

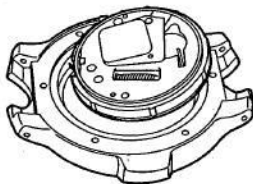

2. Set the setting stem.
3. Set the packing and sheet conduction plate.
  - Match the sheet conduction plate to the two positioning dowels of the plate complete supporter. After setting it, check that the holes of the sheet conduction plate are matched to the screw holes of the case (6 places).

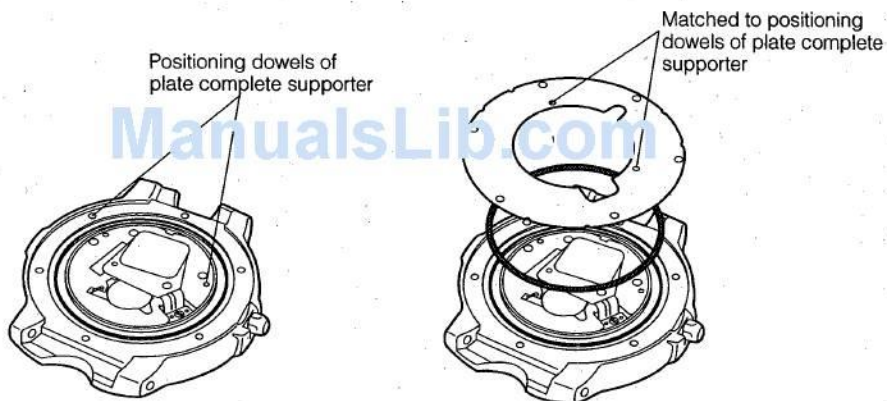

4. Fit the packing to the case back, then set the case back and tighten the case back screws. Set the case back so that the stamp on it will be in parallel with the crown.

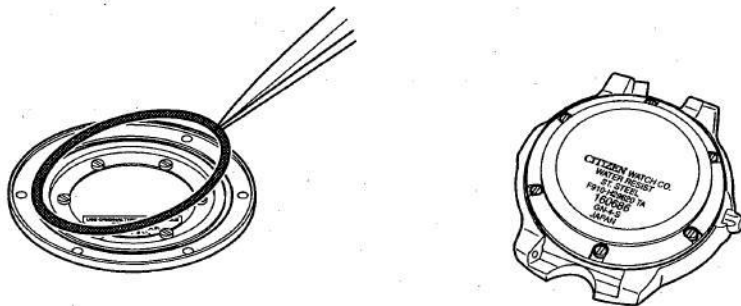

Note: Tighten the six case back screws in the diagonal order. At this time, fit the washers to them without fail.

## How to remove and set "thermogenerator block"

### [How to remove]

The thermogenerator block is secured with the upper hook of the plate complete supporter and thermogenerator strap as shown in the figure. Remove the thermogenerator strap screw and thermogenerator strap, then raise the thermogenerator block and pull it out toward you.

Note: Take care not to damage the silicone printed surface around the thermogenerator block.

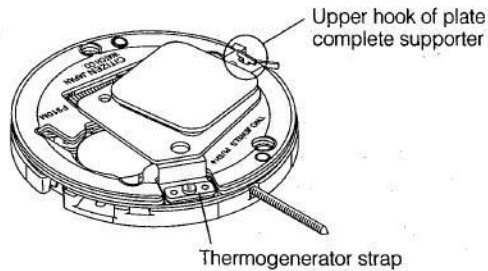

### [How to set]

Slip in the thermogenerator block under the upper hook of the plate complete supporter, then set it, matching to the positioning dowels of the plate complete supporter.

Note: When tightening the thermogenerator strap screw, take care not to damage the thermogenerator sheet.

ManualsLib.com

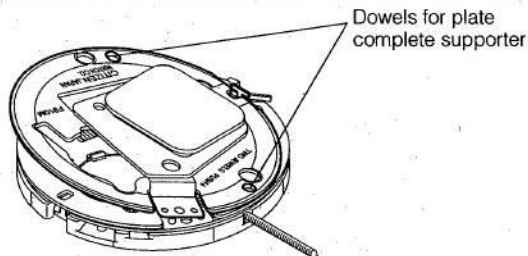

## Setting positions of thermogenerator sheet and thermogenerator block spacer (1)

Note: Do not remove the thermogenerator sheet and thermogenerator block spacer (1) from the thermogenerator block normally. When replacing them because of breakage, etc., observe the following.

1. The thermogenerator sheet is made of soft silicone rubber. Remove it slowly, taking care not to break or damage it.
2. Both sides of a new thermogenerator sheet are covered with protective sheets. Remove those sheets before installing the thermogenerator sheet. When installing thermogenerator sheet, take care of its direction. Install it with the whitish side up.

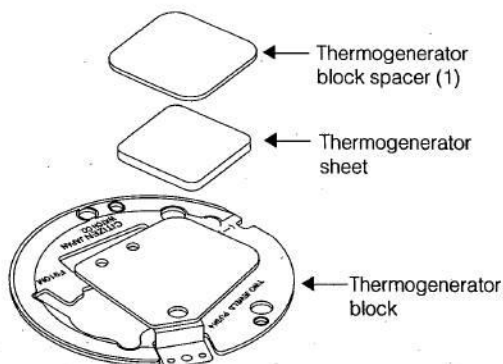

### [Setting position of thermogenerator sheet]

Set the thermogenerator sheet to the guide line and dowel.

Note: Both sides are adhesive. Take care that dirt and dust will not stick to them.

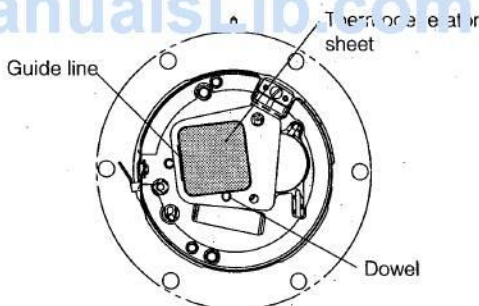

### [Setting position of thermogenerator block spacer (1)]

Set the thermogenerator block spacer (1) to the guide line and contact to the thermogenerator block.

Note: Do not press the top of the thermogenerator block spacer (1) strongly. If it is pressed strongly, it may be deformed.

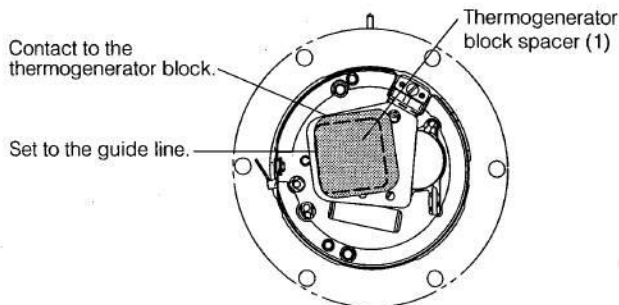



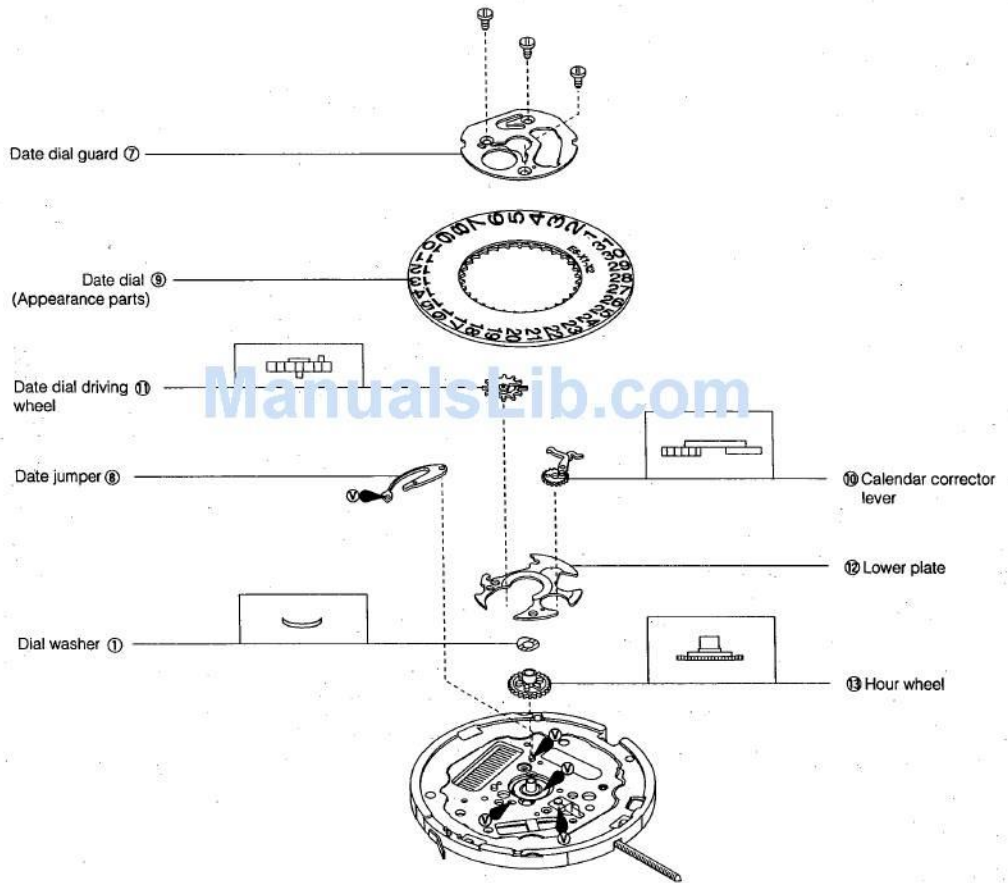

# §12. TROUBLESHOOTING AND ADJUSTMENT

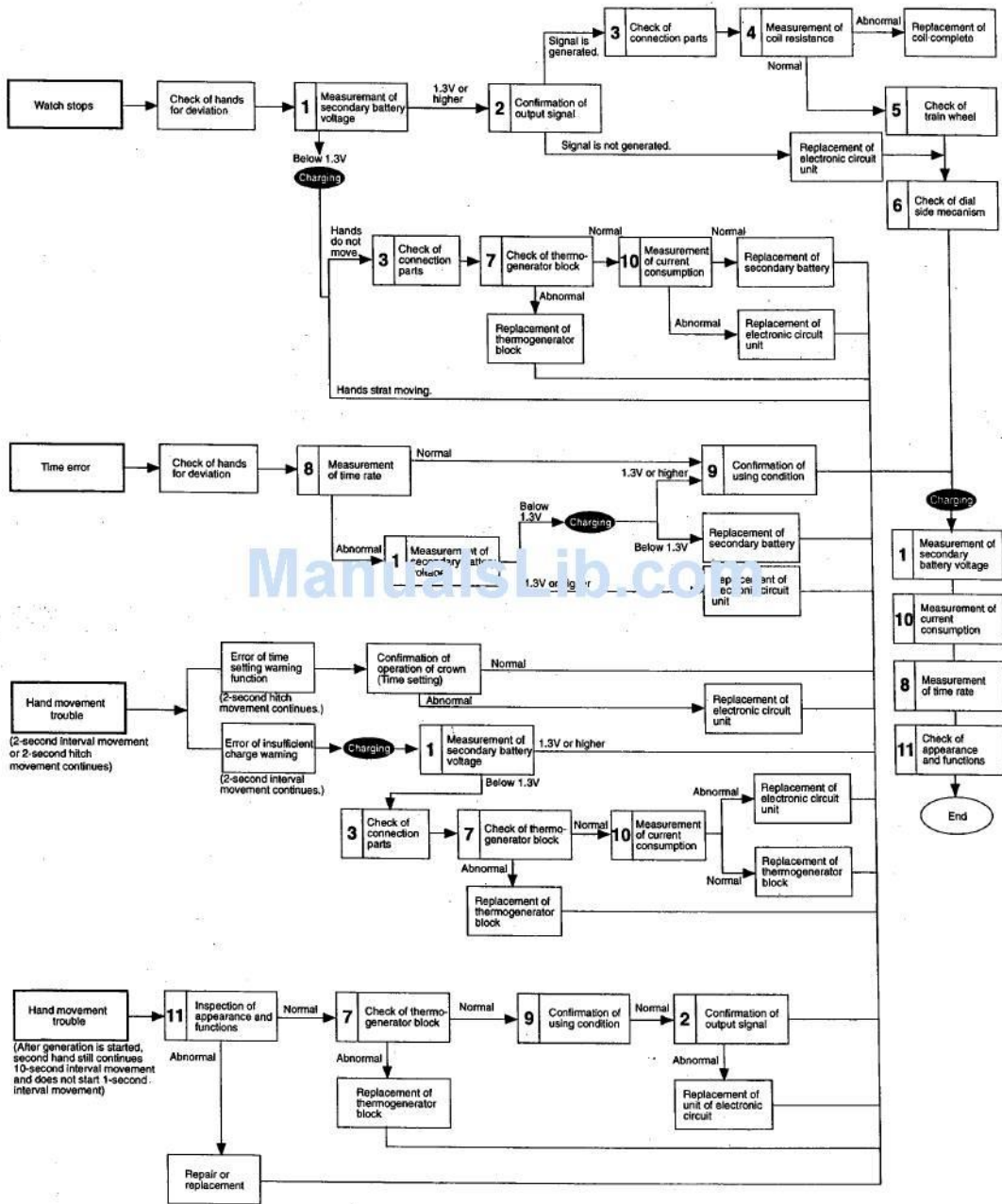

**Charging** Means to charge by wearing the watch on the wrist or by setting to a charger.

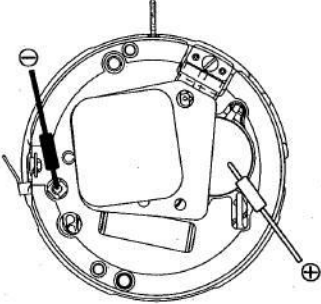
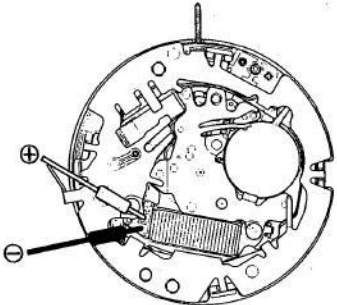
Check Items	How to Check	Results and Treatments
<p>① Measurement of secondary battery voltage</p>	<p style="text-align: right;">&lt;Tester range: DC. 3V&gt;</p>  <p>Reference:</p> <ul style="list-style-type: none"> <li>• 1.1V ~ 1.3V: Two-second interval movement mode</li> <li>• 1.3V ~ 2.6V: One-second interval movement mode</li> </ul> <p>These voltages may vary slightly from watch to watch.</p> <ul style="list-style-type: none"> <li>• Hitch movement is a function that signals that the watch has stopped and restarted.</li> </ul> <p>This mode will continue until the watch is set to the correct magnetic polarity of the voltage.</p> <div style="border: 1px solid black; padding: 5px; margin-top: 10px;"> <p><b>Note:</b> When measuring the voltage, be careful not to place the ⊖ tester pin on the thermogenerator block (a short circuit will occur).</p> </div>	<ul style="list-style-type: none"> <li>• Over 1.3V → Non defective</li> <li>• Under 1.3V → Recharging</li> </ul>
<p>② Confirmation of output signal</p>	<p style="text-align: right;">&lt;Tester range: DC. 0.3V&gt;</p>  <p>• Refer to Technical Manual, Basic Course: II-1-b.</p> <ul style="list-style-type: none"> <li>• In the 1-second interval movement mode, the tester pointer should moves to the right and left every 1 second.</li> <li>• In the 2-second interval movement or hitch movement mode, the test pointer moves in only one direction every 2 seconds.</li> </ul>	<ul style="list-style-type: none"> <li>• Tester pointer swings. → Normal.</li> <li>• Tester pointer does not swing. → Check connections.</li> </ul> <p style="text-align: center;">↓</p> <ul style="list-style-type: none"> <li>• Connections are normal. → Replace the electronic circuit.</li> </ul>

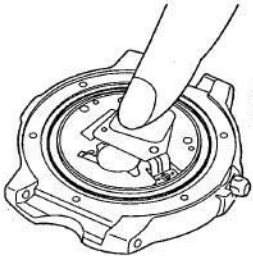
Check Items	How to Check	Results and Treatments
<ul style="list-style-type: none"> <li>● Check of connection parts</li> </ul>	<ul style="list-style-type: none"> <li>* Refer to Technical Manual, Basic Course: II-2-a.</li> <li>• Check for looseness of screws, dust, stain, etc.</li> <li>• Check for stain and breakage of the terminal sheet of thermogenerator block, floating of thermogenerator strap, removal of welded lead plate of the secondary battery, stain of the circuit pattern, and bad contact of each part.</li> </ul>	<p>Stain of terminal sheet of thermogenerator block and circuit pattern.</p> <p>→ Remove stain.</p> <p>Stain or breakage of terminal sheet of thermogenerator block, removal of circuit pattern, removal of welded lead plate of secondary battery.</p> <p>→ Replace parts.</p>
<ul style="list-style-type: none"> <li>● Measurement of coil resistance</li> </ul>	<ul style="list-style-type: none"> <li>* Refer to Technical Manual, Basic Course: II-1-c.</li> <li>• Remove the unit of electronic circuit and measure the coil resistance</li> </ul> <p style="text-align: center;">&lt;Tester range: R x 10Ω&gt;</p> <p style="text-align: center;">&lt;The tester lead pins have no polarity&gt;</p>	<ul style="list-style-type: none"> <li>• 1.9 ~ 2.3kΩ → Normal</li> <li>• Out of above range → Replace coil unit</li> </ul>
<ul style="list-style-type: none"> <li>● Check of train wheel</li> </ul>	<ul style="list-style-type: none"> <li>* Refer to Basic Course: II-2-b.</li> </ul>	
<ul style="list-style-type: none"> <li>● Check of dial side mechanism</li> </ul>	<ul style="list-style-type: none"> <li>* Refer to Basic Course: II-2-c.</li> </ul>	
<ul style="list-style-type: none"> <li>● Check of thermogenerator block</li> </ul>	<p>(1) Check the conductive parts of the appearance parts and thermogenerator block for abnormality.</p> <ul style="list-style-type: none"> <li>* Check for floating of the case back and looseness of the case back screws.</li> <li>* Check the fitting direction of the case back.</li> <li>* Check the setting condition of the sheet conduction plate</li> <li>* Check the setting condition of the thermogenerator block spacer (1).</li> <li>* Check for removal of the silicone print from the thermogenerator block.</li> </ul> <p>(2) Check the generation of the movement.</p> <ul style="list-style-type: none"> <li>* Apply a finger lightly to the top of the thermogenerator block to give some heat to it with taking the movement in the case. Check if generation is indicated (the second hand starts 1-second interval movement) while the finger is on the thermogenerator block.</li> </ul> <div style="text-align: center;">  <p>Apply finger lightly to top of thermogenerator block.</p> </div>	<ul style="list-style-type: none"> <li>• Wrong setting of parts → Set correctly.</li> <li>• Removal of silicon print from thermogenerator block → Replace parts.</li> </ul> <ul style="list-style-type: none"> <li>• 1-second interval movement starts → Check conductive parts of appearance parts and thermogenerator block.</li> <li>• 1-second interval movement does not start → Check setting condition of thermogenerator block.</li> </ul>

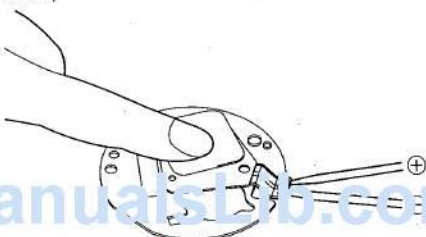
Check Items	How to Check	Results and Treatments
	<p>(3) Check the outside of the thermogenerator block.</p> <ul style="list-style-type: none"> <li>* Check that the thermogenerator sheet and thermogenerator block spacer (1) are set normally.</li> <li>* Check that the terminal sheet of thermogenerator block screw is tightened.</li> <li>* Check the terminal sheet of thermogenerator for breakage.</li> </ul> <p>(4) Check continuity of thermogenerator block.</p> <ul style="list-style-type: none"> <li>* Making a temperature difference between the top and bottom of the thermogenerator block, check the voltage at the terminal sheet of thermogenerator block.</li> </ul> <p>(Apply finger lightly to top of the thermogenerator block.)</p>  <p>Apply the tester pins to the terminal sheet of thermogenerator block to check the voltage.</p>	<ul style="list-style-type: none"> <li>• Wrong setting of parts → Set correctly.</li> <li>• Breakage of thermogenerator sheet → Replace parts.</li> </ul> <ul style="list-style-type: none"> <li>• Voltage is generated → Normal</li> <li>• Voltage is 0 (No voltage) → Replace thermogenerator block.</li> </ul>
<ul style="list-style-type: none"> <li>● Measurement of time rate</li> </ul>	<ul style="list-style-type: none"> <li>* Refer to Technical Manual, Basic Course: II-2-d. &lt;Measurement gate: Analog 10 sec&gt;</li> <li>• The time rate cannot be adjusted.</li> <li>• If the watch is worn on the arm, the second hand starts 1-second interval movement since power is generated. If the watch is removed, however, the second hand starts 10-second interval movement since any power is not generated. Accordingly, measure the time rate at the 10-second gate.</li> </ul>	<ul style="list-style-type: none"> <li>• Watch loses or gains substantial time → Replace electronic circuit unit.</li> </ul>
<ul style="list-style-type: none"> <li>● Confirmation of using condition</li> </ul>	<ul style="list-style-type: none"> <li>• This watch is an analog quartz watch equipped with a thermogeneration function to convert heat into electric energy for driving it.</li> <li>• If this watch is worn on the arm of the user and power is generated, the second hand starts 1-second interval movement. If it is removed from the arm and power is not generated, the second hand starts 10-second interval movement.</li> <li>• It is recommended that the user wear this watch properly to store electric energy.</li> </ul>	

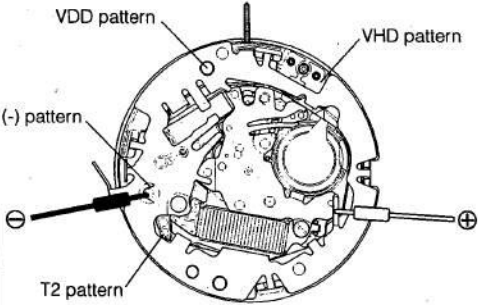
Check Items	How to Check	Results and Treatments
<p>⑨ Measurement of current consumption</p>	<p>* Refer to Technical Manual, Basic Course: II-1-f.</p> <ul style="list-style-type: none"> <li>This watch uses the secondary battery block instead of an ordinary silver battery. Accordingly, prepare a silver battery (1.55V) and measure the current consumption according to the following procedure.</li> </ul> <p style="text-align: center;">&lt;Tester range: D.C. 10<math>\mu</math>A&gt;</p> <ul style="list-style-type: none"> <li>Remove the thermogenerator block and secondary battery.</li> <li>Referring to Technical Manual, Basic Course, set the silver battery (1.55V) to the adapter of the tester correctly.</li> <li>Replace the (+) tester pin with a clip and hitch it to the ground spring of the circuit unit supporter.</li> <li>Apply the (-) tester pin to the (-) pattern of the electronic circuit unit.</li> <li>Short the (-) pattern to the VHD pattern with tweezers so that the second hand will start irregular 2-second interval movement.</li> <li>Pull the crown to the second click and return it to the normal position to reset the irregular 2-second interval movement.</li> <li>Short the VDD pattern to the T2 pattern so that the second hand will start 1-second interval movement.</li> <li>Measure the current consumption.</li> </ul> 	<ul style="list-style-type: none"> <li>Current consumption of movement <ul style="list-style-type: none"> <li>Under 0.7 <math>\mu</math>A → Normal</li> <li>Over 0.7 <math>\mu</math>A → Check train wheel and remove dirt and dust.</li> </ul> </li> </ul> <p style="text-align: center;">↓</p> <ul style="list-style-type: none"> <li>Movement is normal but current consumption is over 0.7 <math>\mu</math>A. → Replace electronic circuit unit.</li> </ul>
<p>⑩ Check of appearance and function</p>	<ul style="list-style-type: none"> <li>Check that the case back is set in the correct direction and the case back screws and washers are installed normally.</li> <li>Wear the watch on the arm and check that its second hand starts stops 10-second interval movement and starts 1-second interval movement.</li> </ul>	