

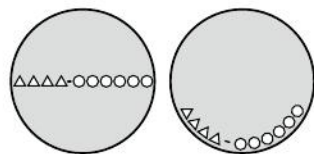



CITIZEN®



Eco-Drive®











		
		





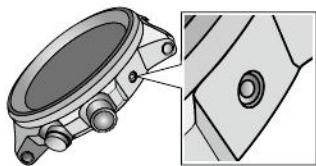



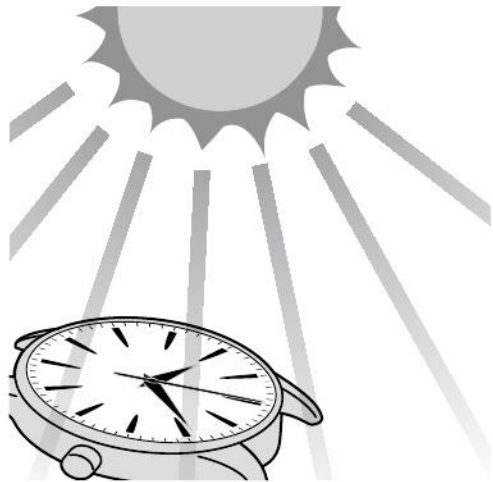

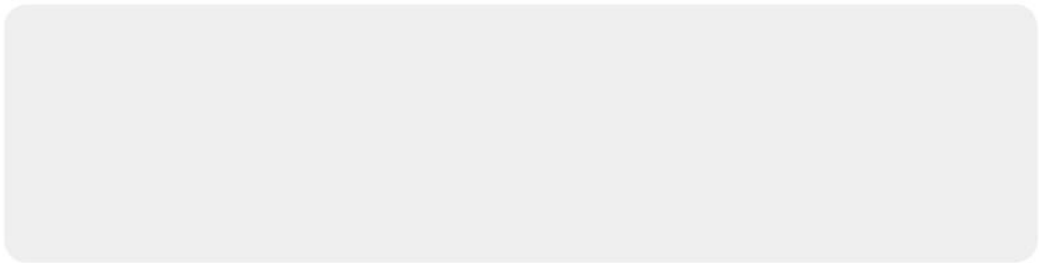

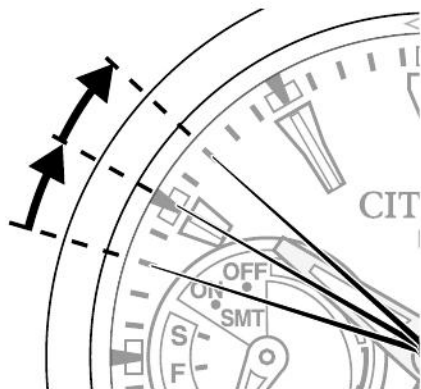
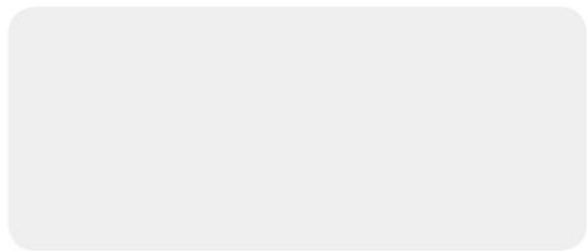

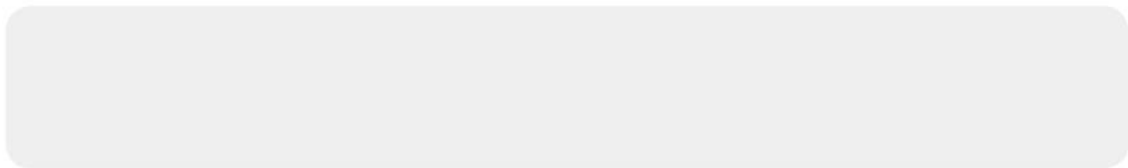

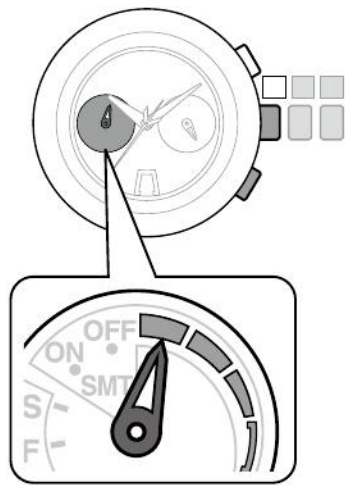

	A semi-circular gauge with a needle pointing to the 10% mark. The scale has five segments. Labels 'OFF', 'ON', and 'SMT' are visible on the left side.	A semi-circular gauge with a needle pointing to the 20% mark. The scale has five segments. Labels 'OFF', 'ON', and 'SMT' are visible on the left side.	A semi-circular gauge with a needle pointing to the 30% mark. The scale has five segments. Labels 'OFF', 'ON', and 'SMT' are visible on the left side.	A semi-circular gauge with a needle pointing to the 40% mark. The scale has five segments. Labels 'OFF', 'ON', and 'SMT' are visible on the left side.



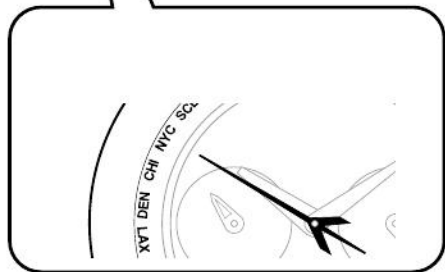
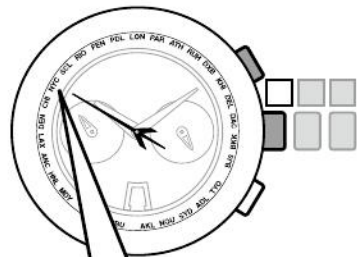

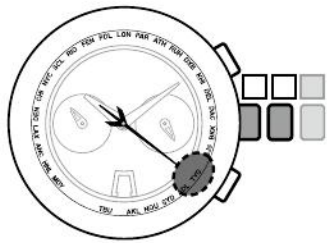

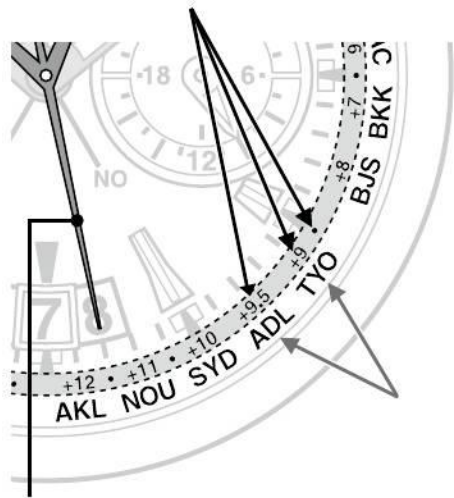



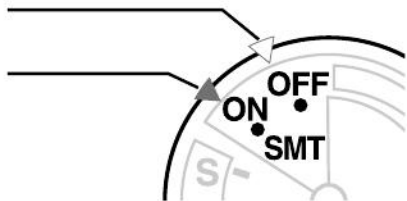
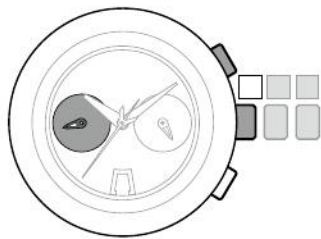

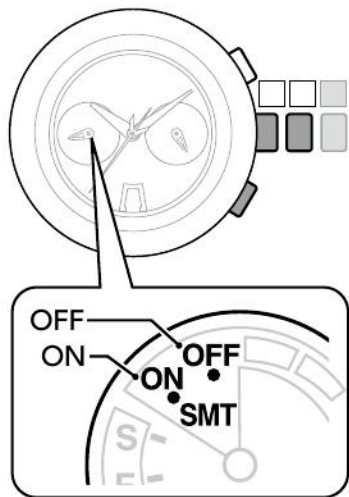

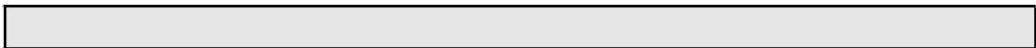



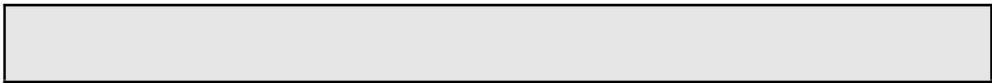

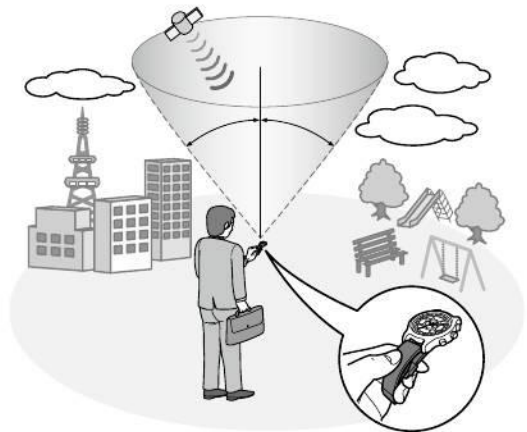

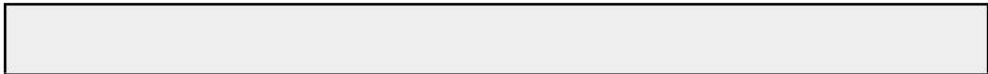
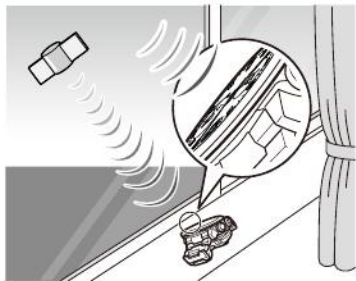



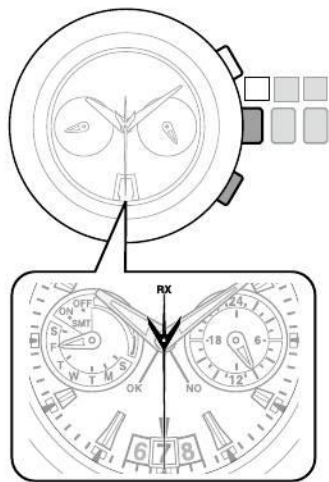







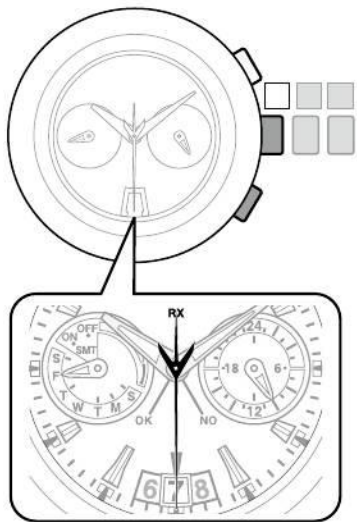

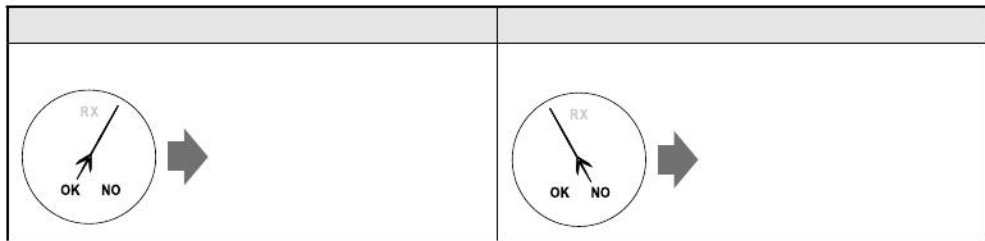

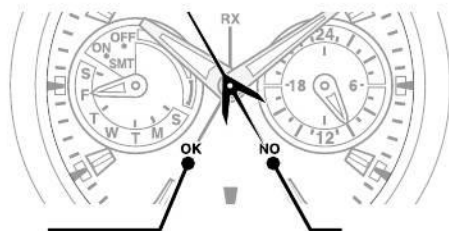
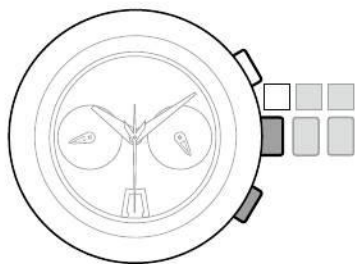

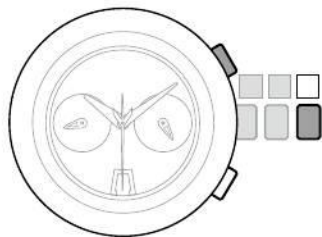

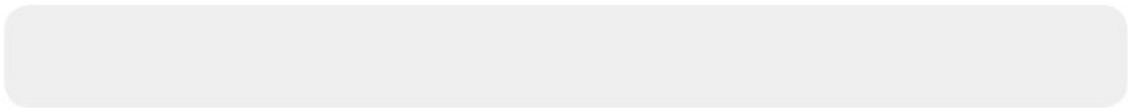

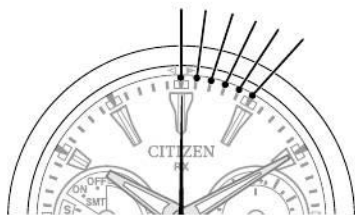
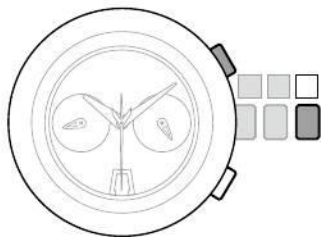



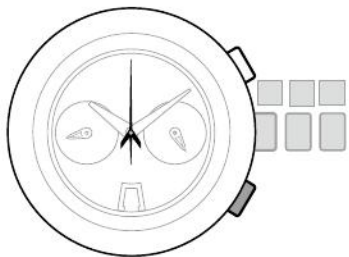
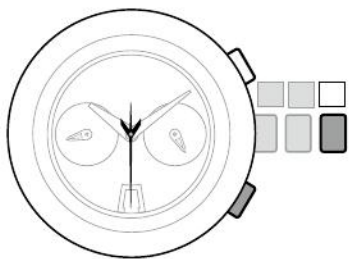

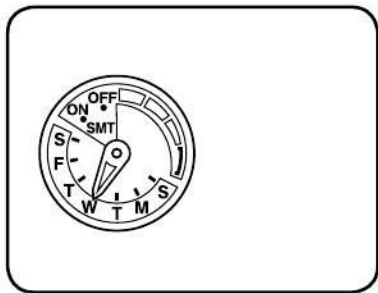
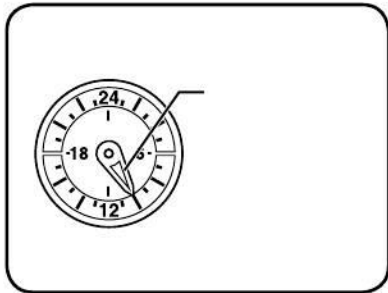
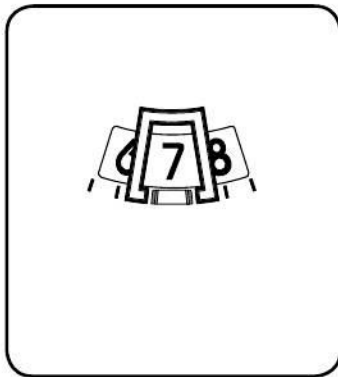
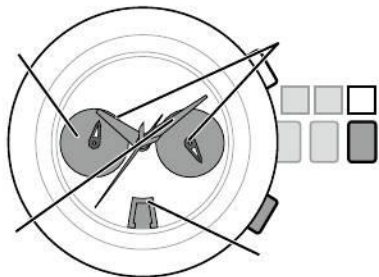

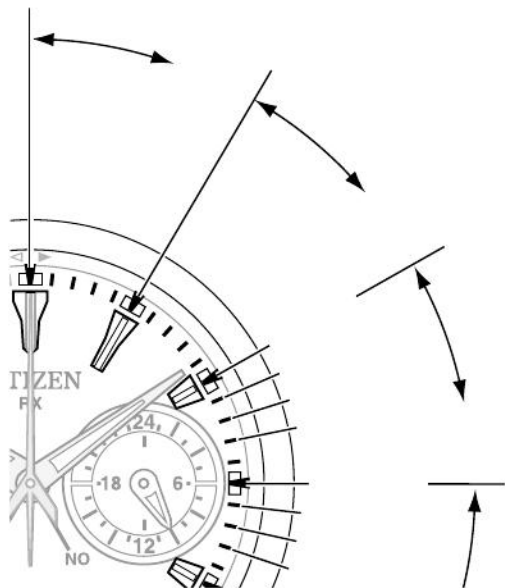

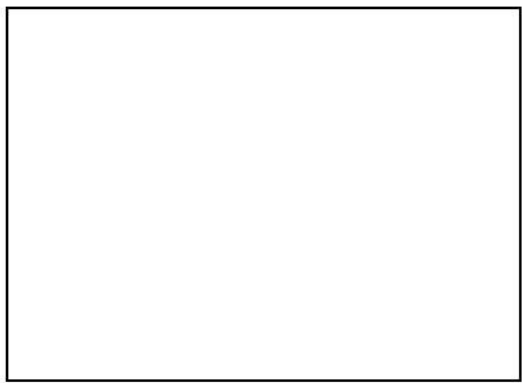
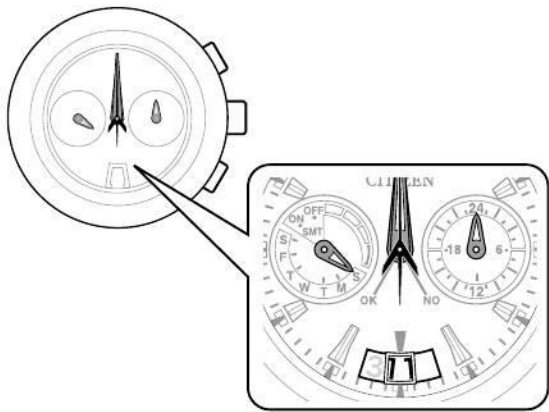

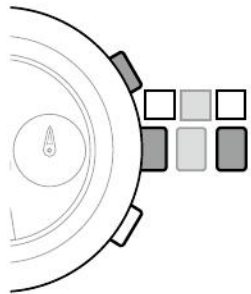

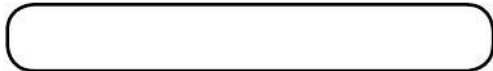
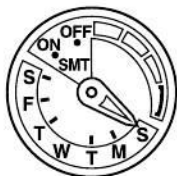
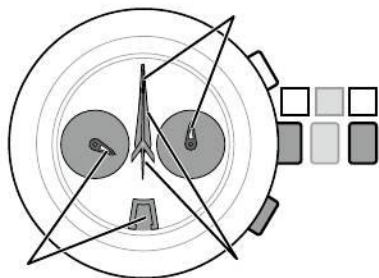

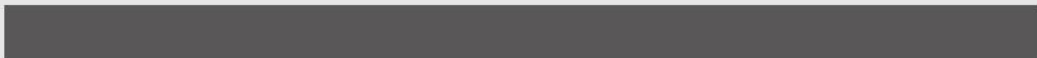



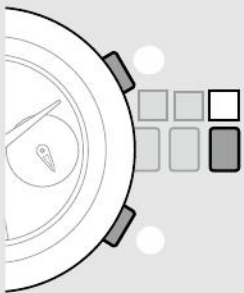

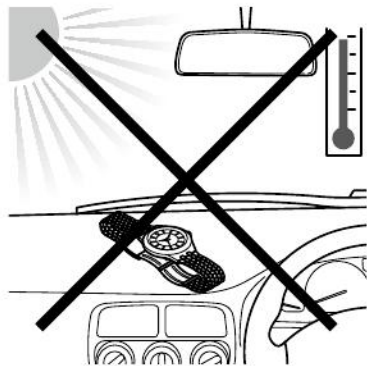















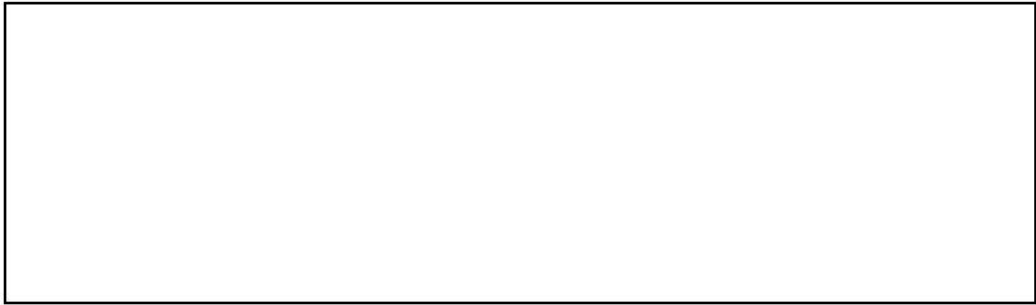

--	--

CE

