

ManualsLib.com

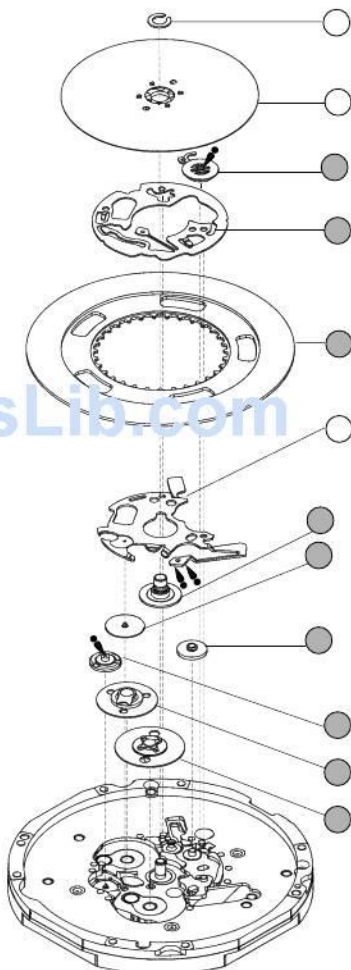

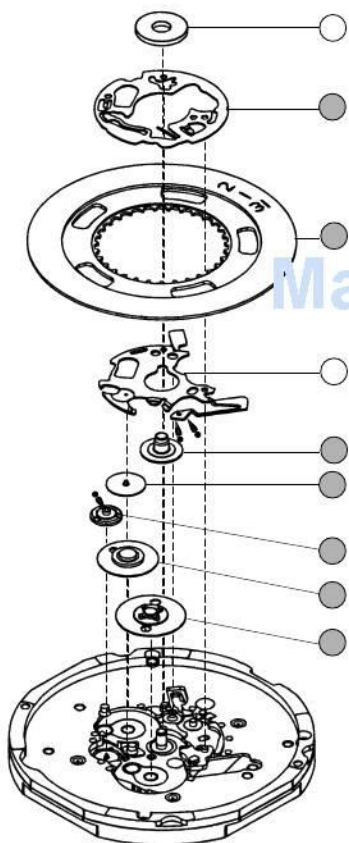



≡





ManualsLib.com





				

ManualsLib.com





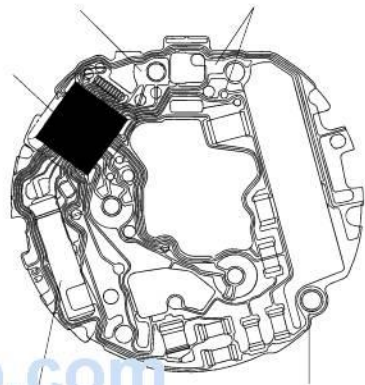
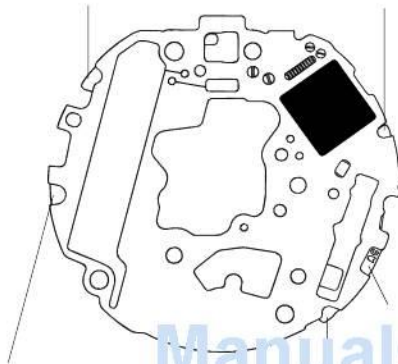

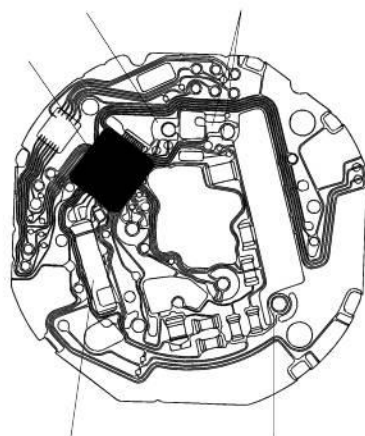
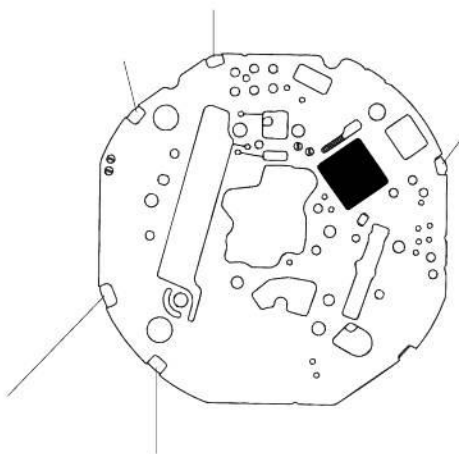
ManualsLib.com

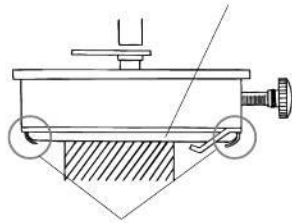

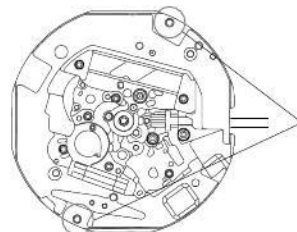
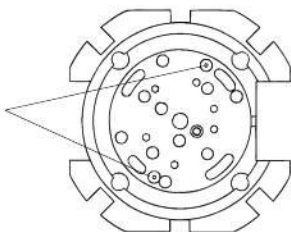
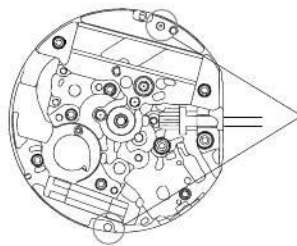
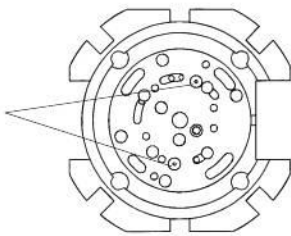

ManualsLib.com



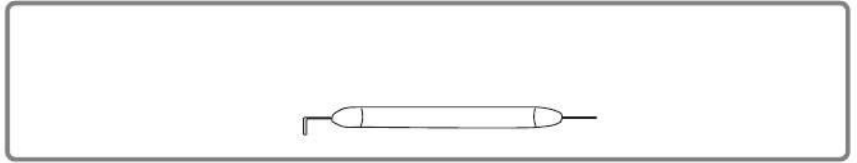
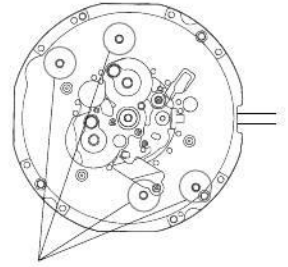
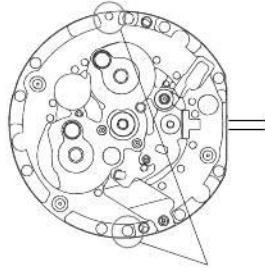
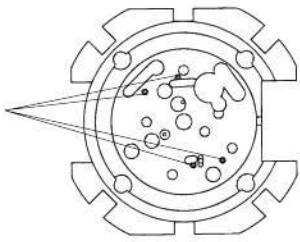

ManualsLib.com

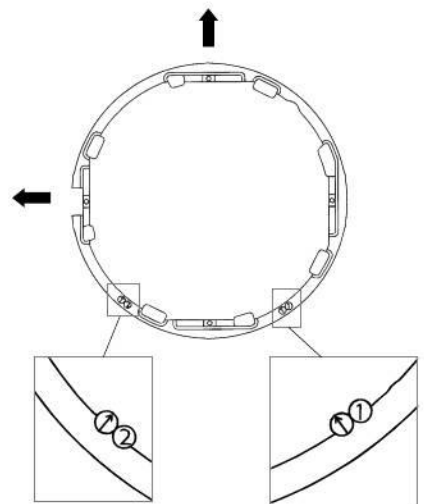
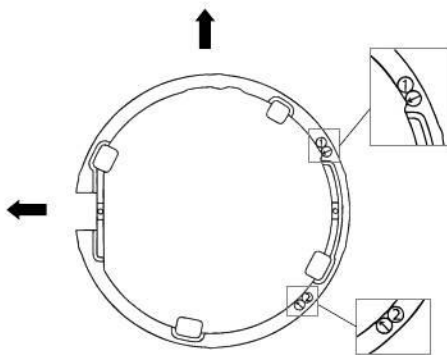

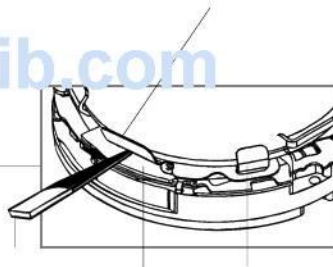
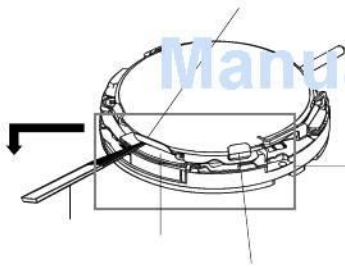
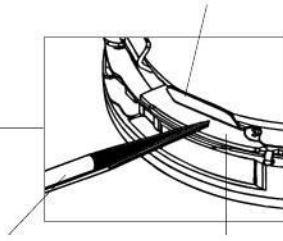
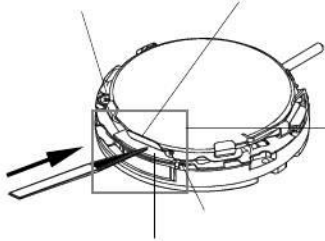

ManualsLib.com

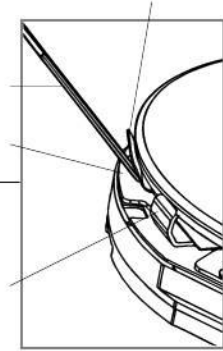
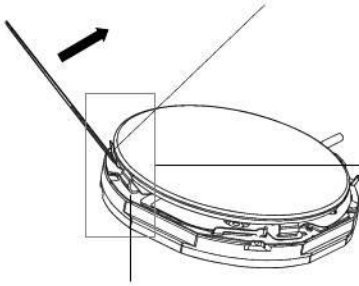

ManualsLib.com

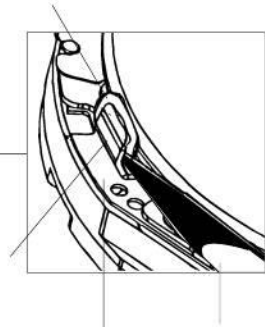
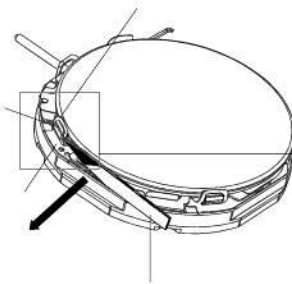

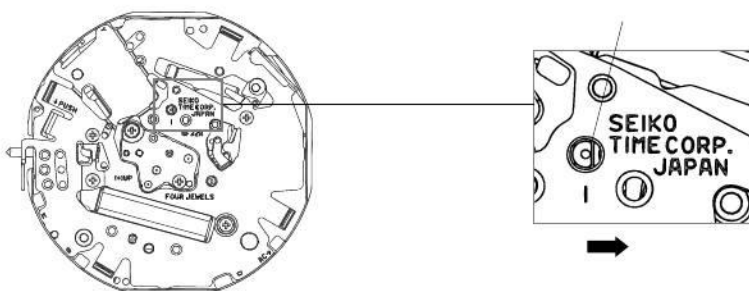

ManualsLib.com

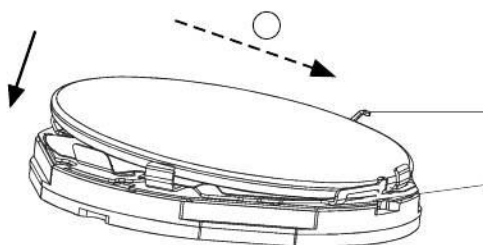
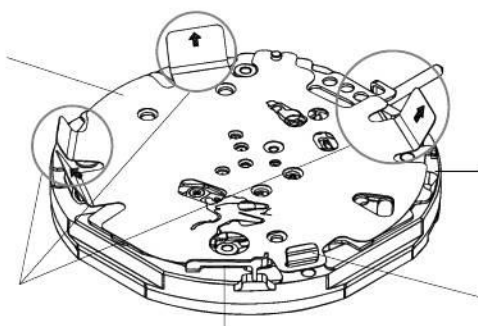



ManualsLib.com

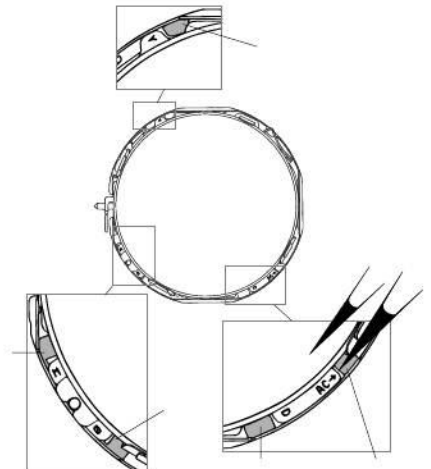
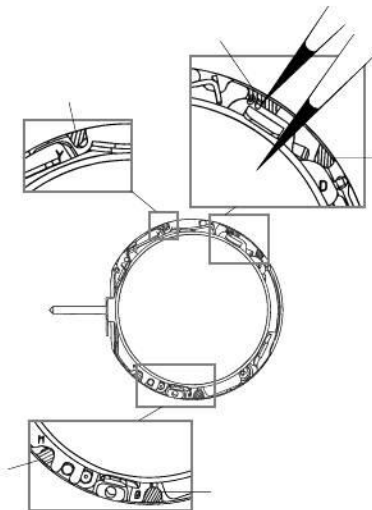
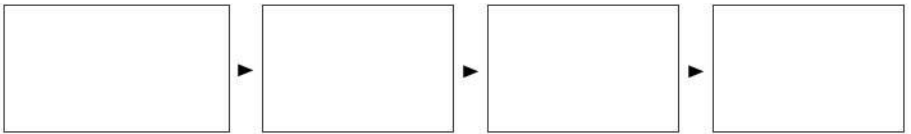



ManualsLib.com



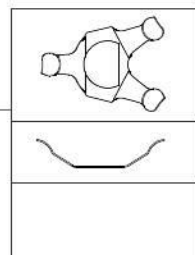
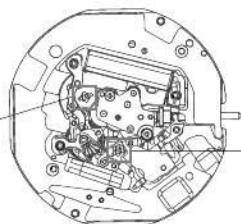
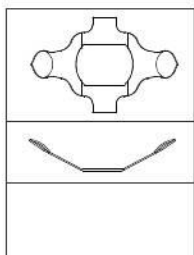
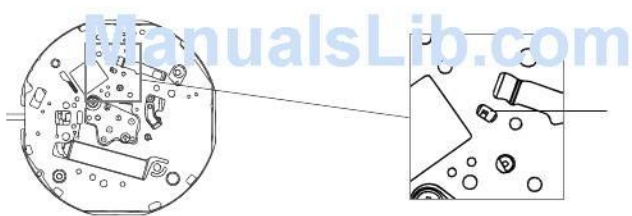
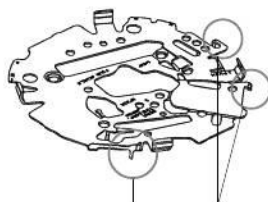

ManualsLib.com

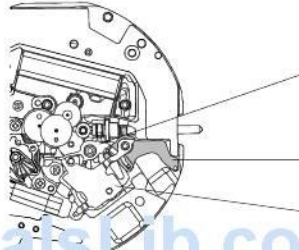
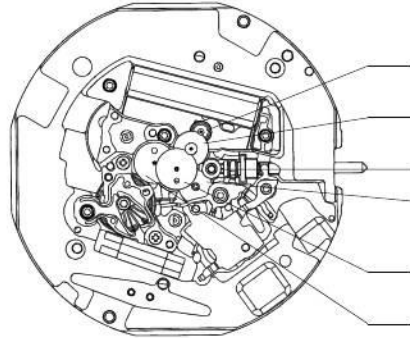

ManualsLib.com

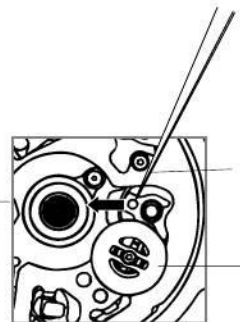
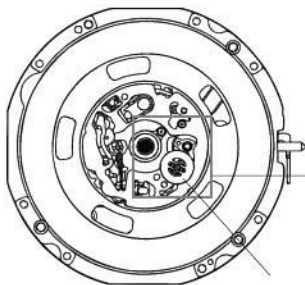
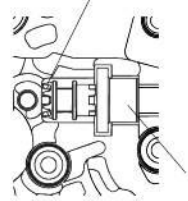

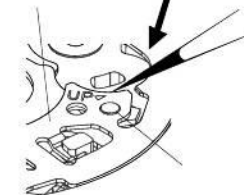
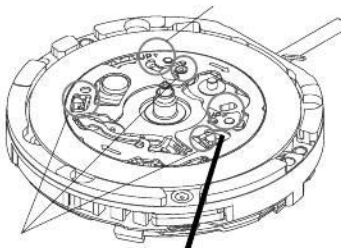

ManualsLib.com

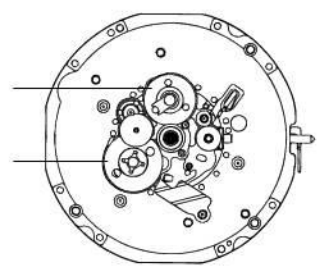
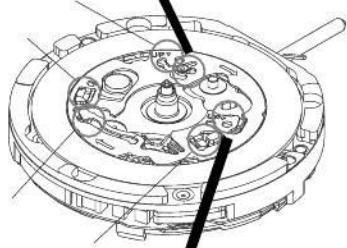
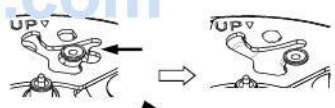

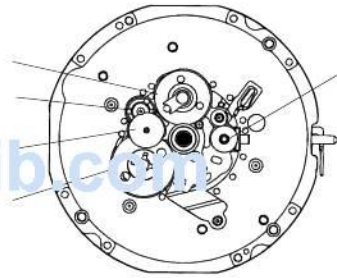
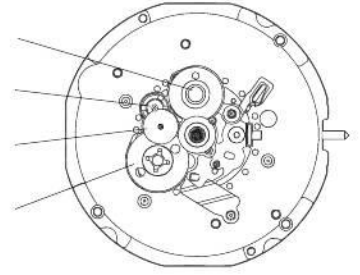
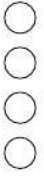

ManualsLib.com

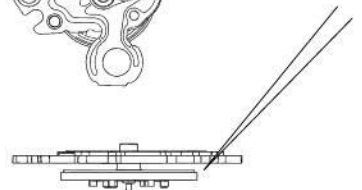
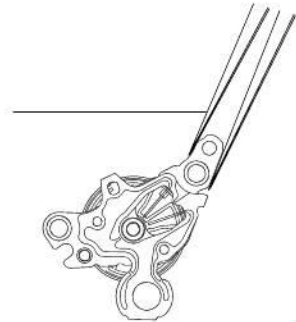
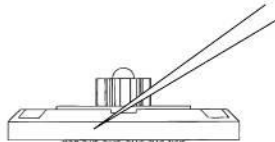
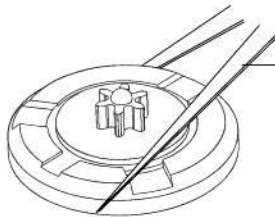

•



•





○		
○		
○		
		-
		-
		-
		-
		-

ManualsLib.com

X	○	
○	X	
X	X	

○ X

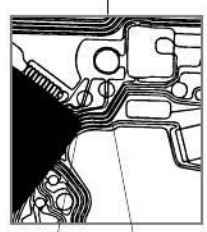
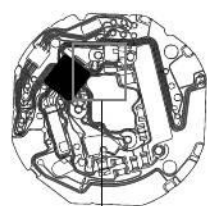

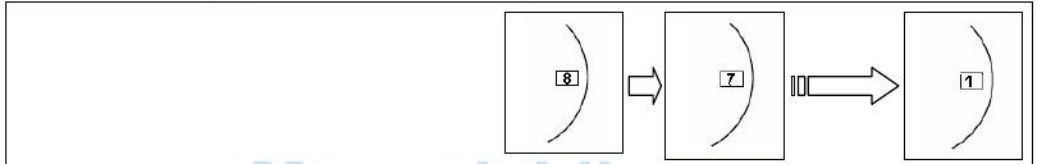
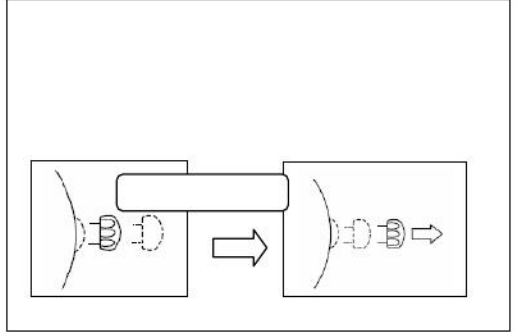
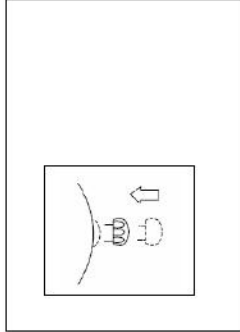
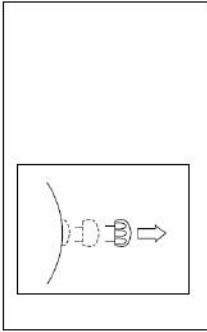

ManualsLib.com

Date	Adjustable seconds
1	0.056
2	0.048
3	0.04
4	0.032
5	0.024
6	0.016
7	0.008
8	0
9	-0.008
10	-0.016
11	-0.024
12	-0.032
13	-0.04
14	-0.048
15	-0.056

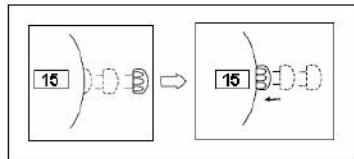
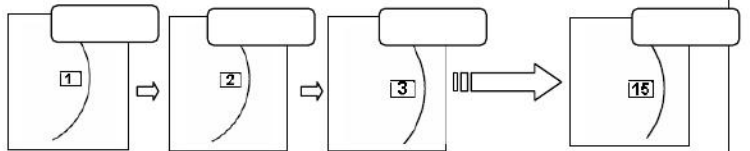

ManualsLib.com

