

6R54 / 6R55

2405

SEIKO WATCH CORPORATION  
Copyright©2024 by SEIKO WATCH CORPORATION

# SEIKO

6R54 / 6R55

DIVER'S WATCH FOR AIR DIVING INSTRUCTIONS

日本語 ..... **JA 1**

English ..... **EN 1**

そのほかの言語の取扱説明書は、パソコンやスマートフォンから当社ホームページ内の「カスタマーサービス」>「取扱説明書」にアクセスいただき、ご覧ください。

Please refer to the Instruction Manuals of other languages by accessing "Customer Service"→ "Instruction" on our Website from PC or Smartphone.

Deutsch / Français / Italiano / Español /  
Русский язык / العربية / Português /  
简体中文 / 繁體中文 / 한국어 / ไทย



<https://www.seikowatches.com/>

**Thank you very much for choosing a SEIKO watch.  
For proper and safe use of your SEIKO watch,  
please read carefully the instructions in this  
booklet before using it.**

- \* Length adjustment service for metallic bands is available at the retailer from whom the watch was purchased. If you cannot have your watch repaired by the retailer from whom the watch was purchased because you received the watch as a gift, or you moved to a distant place, please contact SEIKO CUSTOMER SERVICE CENTER. The service may also be available on a chargeable basis at other retailers, however, some retailers may not undertake the service.
- \* If your watch has a protective film for preventing scratches, make sure to peel it off before using the watch. If the watch is used with the film on it, dirt, sweat, dust, or moisture may be attached to the film and may cause rust.

**⚠ CAUTION**  
Make sure to read the following instructions before use and strictly observe them.

**⚠ CAUTION**

Inspect the following items before diving (excluding saturation diving):

- The watch is operating normally.
- The remaining battery level is sufficient and the mainspring is sufficiently wound.
- The rotating bezel turns smoothly. (The bezel rotation must not be too loose or too tight.)
- Screws of the crown and other parts are reliably tightened.
- No abnormalities such as flaws or cracks exist on the band or glass.
- The band is reliably fixed (with spring bar, buckle or other parts.)

\* If any abnormality is observed in the above items, do not use this watch for diving.

**⚠ CAUTION**

Do not operate the crown or buttons underwater.

**⚠ CAUTION**

As the use environment of the diver's watch may affect not only the case or band but also the internal mechanism of the watch, we recommend that you periodically request an overhaul for inspection and adjustment approximately once every two to three years.

**⚠ WARNING**  
Make sure to read the following instructions before use and strictly observe them.

**⚠ WARNING**

When diving, never carry out operations other than those specified in this instruction manual. Mishandling of the product and misunderstanding of the displayed content may lead to a fatal or serious accident.

**⚠ WARNING**

The diver's watch is an auxiliary instrument which mainly displays the passage of time and does not ensure the safety of a user. Use this watch while using the equipment (residual pressure gauge, water depth meter, etc.) required for safe diving.

**⚠ WARNING**

Never use this watch for "saturation diving" using helium gas.

**⚠ WARNING**

Do not dive using this product unless you have been properly trained in scuba diving, acquired the requisite experience and techniques for safe diving, thoroughly familiarized yourself with the operation and handling of this product, and inspect all functions of this product prior to each dive.

**CONTENTS**

|  |    |
|--|----|
| <b>1 HOW TO USE</b>  |    |
| Handling cautions .....  | 5  |
| Precautions for diving (Please make sure to observe the following) ..... | 9  |
| Before diving .....  | 9  |
| While diving .....   | 11 |
| After diving .....   | 12 |
| Structure of the case .....  | 13 |
| Mechanical watch characteristics (Hand-wound, auto-wound) .....          | 14 |
| Names of the parts and their functions .....                             | 15 |
| Screw down crown .....   | 16 |
| How to wind the mainspring .....   | 17 |
| How to set the time, 24-hour hand, and date (6R54) .....                 | 19 |
| How to set the time and date .....                                       | 19 |
| Date setting .....   | 24 |
| Date adjustment at the end of the month ...                              | 25 |
| How to use the 24-hour hand .....  | 26 |
| How to set the time and date (6R55) .....                                | 28 |
| Date adjustment at the end of the month ...                              | 31 |
| How to use the rotating bezel .....                                      | 32 |
| <b>2 TO PRESERVE THE QUALITY OF YOUR WATCH</b>                           |    |
| Daily care .....   | 34 |
| Performance and type .....   | 35 |
| Lumibrite .....  | 36 |
| Magnetic resistant performance .....                                     | 37 |
| Band .....   | 39 |
| How to use the diver adjuster .....                                      | 42 |
| How to use the diver extender .....                                      | 44 |
| How to use the pull-through type band .....                              | 46 |
| After sales service .....  | 49 |
| Accuracy of mechanical watches .....                                     | 51 |
| Troubleshooting .....  | 53 |
| Specifications .....   | 55 |

## Handling cautions

### ⚠ WARNING

Please note that there is a risk of serious consequences such as severe injury if the following safety regulations are not strictly observed.

#### Immediately stop wearing the watch in following cases:

- If the watch body or band becomes edged by corrosion etc.
- If the pins protrude from the band.
- \* Immediately consult the retailer from whom the watch was purchased or SEIKO CUSTOMER SERVICE CENTER.

#### Keep the watch and accessories out of the reach of babies and children.

Care should be taken to prevent a baby or a child accidentally swallowing the accessories. If a baby or child swallows the battery or accessories, immediately consult a doctor, as it will be harmful to the health of the baby or child.

EN 5

### ⚠ WARNING

Never use the watch, in saturation diving using helium gas.

### ⚠ WARNING

While diving, never operate the watch in any other manner than set forth in the instruction manual.

### ⚠ WARNING

Before using the diver's watch, you have to be properly trained in various types of diving and possess the requisite experience and skill to dive safely. When diving, strictly abide by the rules of diving.

EN 7

### ⚠ CAUTION

Please note that there is a risk of minor injury or material damage if the following safety regulations are not strictly observed.

#### Avoid the following places for wearing or keeping the watch:

- Places where volatile agents (cosmetics such as polish remover, bug repellent, thinners etc.) are vaporizing
- Places where the temperature drops below 5°C or rises above 35°C for a long time
- Places affected by strong magnetism or static electricity
- Places affected by strong vibrations
- Places of high humidity
- Dusty places

#### If you observe any allergic symptoms or skin irritation

Stop wearing the watch immediately and consult a specialist such as a dermatologist or an allergist.

#### Other cautions

- For adjusting the length of the metallic band, specialized knowledge and expertise are necessary. Therefore, in such a case, contact the retailer from whom the watch was purchased. If you attempt to adjust the metallic band, injury may occur to your hand or fingers, or parts of the band may be lost.
- Do not disassemble or tamper with the watch.
- Please follow local government directions when disposing of the watch body.
- Keep the watch out of the reach of babies and children. Extra care should be taken to avoid risks of any injury or allergic rash or itching that may be caused when you touch the watch.
- If your watch is of the fob or pendant type, the strap or chain attached to the watch may damage your clothes, or injure the hand, neck, or other parts of your body.

EN 6

### ⚠ CAUTION

Please note that there is a risk of minor injury or material damage if the following safety regulations are not strictly observed.



#### Do not turn or pull out the crown when the watch is wet.

Water may get inside of the watch.

\* If the inner surface of the glass is clouded with condensation or water droplets appear inside of the watch for a long time, the water resistant performance of the watch is deteriorated. Immediately consult the retailer from whom the watch was purchased or SEIKO CUSTOMER SERVICE CENTER.



#### Do not leave moisture, sweat and dirt on the watch for a long time.

Be aware of a risk that a water resistant watch may lessen its water resistant performance because of deterioration of the adhesive on the glass or gasket, or the development of rust on stainless steel.



#### Do not wear the watch while taking a bath or a sauna.

Steam, soap or some components of a hot spring may accelerate the deterioration of water resistant performance of the watch.

EN 8

# 1 Precautions for diving (Please make sure to observe the following)

HOW TO USE

## ■ Before diving

Before diving, check the following:  
\* "Names of the parts and their functions" → P.15

- 1 The time is correctly set.
- 2 Turn the crown to wind up the watch so that it does not stop in the water.  
\* "Screw down crown" → P.16  
\* "How to wind the mainspring" → P.17
- 3 The rotating bezel turns smoothly.  
(The bezel rotation must not be too loose or too tight.)  
\* "How to use the rotating bezel" → P.32

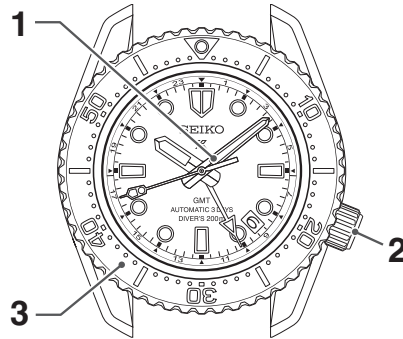

EN 9

## 1 ■ While diving

Please observe the following cautions for use.



The watch can be used for air diving within the water resistant range displayed on the dial.



Take care not to bump the watch against hard objects such as rocks.

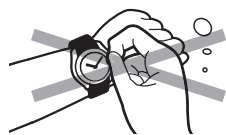

Do not operate the crown or buttons underwater.



Bezel rotation may become slightly harder in the water but this is not a malfunction.

EN 11

- 4 The crown is completely screwed in.  
\* "Screw down crown" → P.16

- 5 There are no visible cracks or scratches on the crystal or watch band.

- 6 The band is firmly attached to the watch (with spring bars, clamp or other parts.)



HOW TO USE

## ⚠ CAUTION

If there are any malfunctions, contact the retailer from whom the watch was purchased or SEIKO CUSTOMER SERVICE CENTER.

EN 10

## ■ After diving

Please follow the care instructions below after diving.



Rinse the watch in fresh water to wash out all seawater and wipe it thoroughly dry to prevent rust. Avoid pouring running water onto the watch directly from a faucet. Put some water into a bowl first, and then soak the watch in the water to wash it.



## ⚠ CAUTION

Depending on the environment where a diver's watch is used, its inner parts or movement as well as its case or band may be affected. We recommend that you have your watch overhauled regularly once every 2 or 3 years.

HOW TO USE

EN 12

## ■ Structure of the case

In the following types of models, take care of the following issues in usage.

**The bezel or protective outer case is securely fastened to the watch with setscrews. Never loosen the setscrews.**



\* The above illustration is provided as an example, therefore it may not be exactly the same as your watch.

### ⚠ CAUTION

Never loosen the setscrews used to fix the bezel or protective outer case. Doing so may cause damage or result in further loosening.

\* If you find that the setscrews have become loose or are functioning abnormally, consult the retailer from whom the watch was purchased or SEIKO CUSTOMER SERVICE CENTER.

## Mechanical watch characteristics (Hand-wound, auto-wound)

- This is a mechanical watch powered by a spring.
- To use it from a stopped state, turn the crown 20 turns by hand to wind up the spring before starting the watch.
- Although the accuracy of quartz watches is measured in differences over months or years, in mechanical watches it is measured in differences per day (i.e., the amount the watch speeds up or slows down in a single day).
- Additionally, mechanical watches are subtly affected by the conditions in which they are used (e.g., duration worn, temperature, arm movement, the amount wound, etc.); thus, the amount of error is not constant.
- When affected by a strong magnetism from outside, the mechanical watch may lose/gain time. The parts of the watch may become magnetized depending on the extent of the effect. In such a case, consult the retailer from whom the watch was purchased since the watch requires repair including demagnetizing.

## Names of the parts and their functions

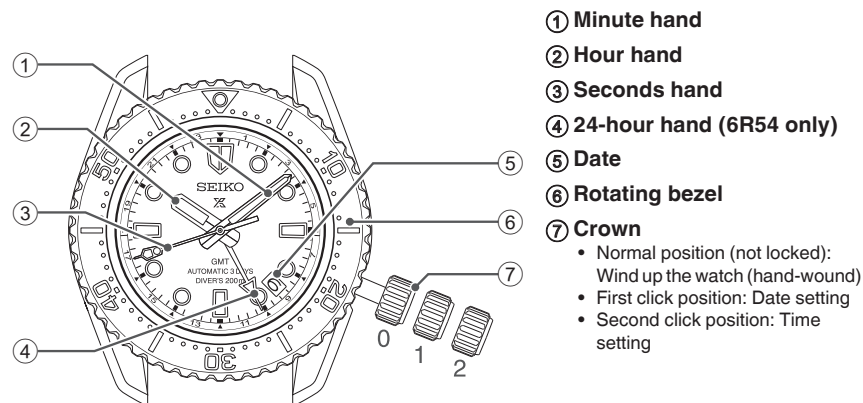

- ① Minute hand
- ② Hour hand
- ③ Seconds hand
- ④ 24-hour hand (6R54 only)
- ⑤ Date
- ⑥ Rotating bezel
- ⑦ Crown
  - Normal position (not locked): Wind up the watch (hand-wound)
  - First click position: Date setting
  - Second click position: Time setting

\* The position and design of the display may vary depending on the model.

## Screw down crown

The screw down crown features a mechanism that can securely lock the crown when it is not being operated in order to prevent any operational errors and to improve its water resistant performance.

- **It is necessary to unlock the screw down crown before operating it.**
- **Once you have finished operating the crown, make sure to relock it.**

### [To unlock the crown]

Turn the crown counterclockwise to unscrew it. Now the crown can be operated.

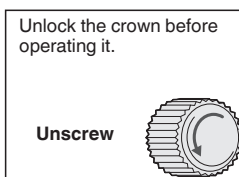

Crown locked

### [To lock the crown]

Turn the crown clockwise while gently pressing it in toward the watch body until it stops.

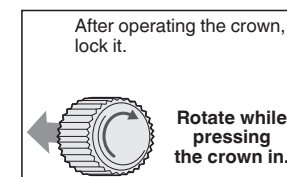

Crown unlocked

\* When locking the crown, turn it slowly with care, ensuring that the screw is properly engaged. Be careful not to push it in forcefully, as doing so may damage the screw hole in the case.

## How to wind the mainspring

- This is an **automatic mechanical watch with a manual winding mechanism**.
- When the watch is worn on the wrist, the mainspring is wound automatically through normal wrist movement. The watch can also be wound up by turning the crown.
- To start the watch after it stops completely, wind it up either by turning the crown or swinging it from side to side until the seconds hand starts moving. Then, set the time and date before putting the watch on the wrist. To wind up the watch, turn the crown clockwise slowly. The watch cannot be wound by turning the crown counterclockwise. In this way, the watch can be wound up fully. Furthermore, turning the crown further will not break the spring.
- \* For the watch with screw down crown, please unlock the crown before operating it and be sure to lock the crown after operating it.
- Once the watch is wound up fully, it operates for about 72 hours.

## 1 How to set the time, 24-hour hand, and date (6R54)

### ■ How to set the time and date

The watch is provided with a date function and is so designed that the date changes once every 24 hours.

It also is provided with a 24-hour hand. When using it as a 24-hour hand, it can be used to check whether the displayed time is AM or PM.

When using the hand for dual time display (indicating the time of two different regions), pull out the crown to the second click, turn the crown to advance the hand and be sure that AM/PM is set correctly as the date changes.

The date changes around 12 o'clock midnight. Therefore, if the time is not properly set with regard to AM/PM, the date will change at 12 o'clock noon.

\* To adjust the date only on a day such as the next day after the completion of a month that has less than 31 days (February, April, June, September and November), please refer to "Date adjustment at the end of the month" → P.25.

### ⚠ CAUTION

Do not set the date between 9:00 p.m. and 1:00 a.m.  
Amending the date during this time period may cause problems such as the date failing to change the next day.

- \* If the watch is used without being wound up fully, gain or loss of time may result. To avoid this, wear the watch for more than 10 hours a day. If the watch is used without being worn on the wrist, be sure to wind it up fully every day at a fixed time.
- \* If you use a watch that has stopped with the mainspring unwound, winding the mainspring with the crown will not start the watch immediately. That is because the mainspring torque or force is low at the beginning of its winding due to the characteristics of mechanical watches. The seconds hand will start to move when a certain degree of torque is reached after the mainspring has been wound up. However, swinging the watch from side to side to forcibly turn the balance can start the watch sooner.

### 1 Make sure that the watch is working.

\* To carry out the procedure, please make sure that the watch is in a working state. Please wind the mainspring when the watch is not working.

### 2 Unlock the crown.

\* "Screw down crown" → P.16

### 3 Pull out the crown to the first click.



### 4 Turn the crown counterclockwise to set the date.

Turn it until the previous day's date appears.  
Ex.) To display the date as "7", then set this to "6".  
Turn the crown counterclockwise to set the date.



## 5 Pull out the crown to the second click and set the time.

Pull out the crown to the second click when the seconds hand is at the 12 o'clock position; the seconds hand stops on the spot.

Turn the crown to advance the hands until the date changes to the following date. The time is now set for the A.M. period. Advance the hands to set the correct time.

\* To set the time correctly, be sure to turn back the minute hand a little behind the desired time and then advance it to the exact time.

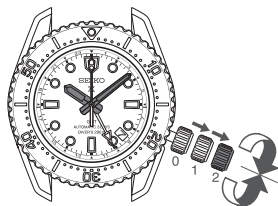

## 6 Push the crown back in to the normal position in accordance with a time signal.

The seconds hand immediately starts moving.

\* The telephone time signal service is helpful for setting the seconds hand exactly.

EN 21

## 9 Push the crown back in to the normal position.

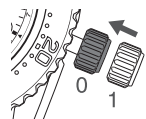

Push the crown back in to the normal position

## 10 Relock the crown.

\* "Screw down crown" → P.16

EN 23

Next, set the 24-hour hand.

## 7 Pull out the crown to the first click.

The seconds hand continues moving.

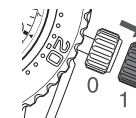

Pull out the crown to the first click

## 8 Turn the crown clockwise to adjust the 24-hour hand.

Turn the crown to set the 24-hour hand to the correct time.



The 24-hour hand moves clockwise

## ■ Date setting

The date is linked to the time and changes once every 24 hours, whether the watch is running or the crown is used to adjust the time. When the time is advanced across a day, the date is also advanced. Even when the time is set back across a day, the date will not be set back.

- When the watch is running, the date changes at around midnight (between 11:45 PM and 0:30 AM).
- When the crown is used to adjust the time, the date changes between 9:00 PM and 1:00 AM of the next day. The date will then change at around midnight (between 11:45 PM and 0:30 AM) when the watch is running normally.

### ● When setting the time between 9:00 PM and 1:00 AM the next day

- When setting the time between 9:00 PM and 1:00 AM the next day, first set the time back before 9:00 PM (or ahead of 1:00 AM) and make sure that the date is correct before setting the time.
- When the time is advanced or set back to between 9:00 PM and 1:00 AM the next day, the date may not change at around midnight. However, the date will change to the day after the date at 9:00 PM (i.e., the date at 1:00 AM) after 1:00 AM. Also, when the watch is running, the timing at which the date changes will return to the normal timing.

EN 24

## ■ Date adjustment at the end of the month

It is necessary to adjust the date at the end of February and 30-day months.

Ex.) To adjust the date in the A.M. period on the first day of a month following a 30-day month

The watch displays "31" instead of "1". Pull out the crown to the first click.

Turn the crown counterclockwise to set the date to "1" and then push the crown back in to the normal position.

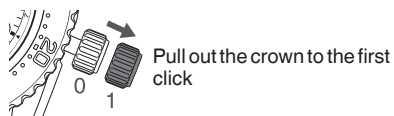

### ⚠ CAUTION

- Return the screw down crown fully to its original position.
- Do not set the date between 9:00 p.m. and 1:00 a.m.  
Amending the date during this time period may cause problems such as the date failing to change the next day.

EN 25

## ● Indicating the time of two different regions (As a dual time indicator)

It is possible to indicate the time of a region that is different from the time indicated by the hour and minute hand.

Please refer to "How to set the time and date" → P.19 when changing the time display.

【Example 1】

Hour hand, date : A region (Japan)  
24-hour hand : B region (Honolulu)

【Example 2】

Hour hand, date : B region (Honolulu)  
24-hour hand : A region (Japan)

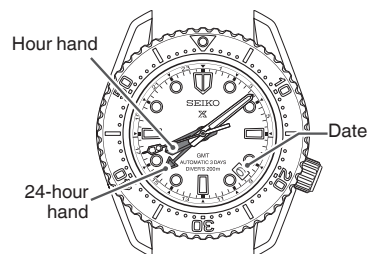

Japan : At 8:08 AM on 6th  
Honolulu : At 3:08 PM on 5th

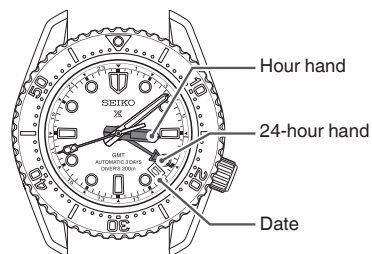

EN 27

## ■ How to use the 24-hour hand

There are two ways to use the 24-hour hand as follows.

### ● Distinguishing between AM and PM (Standard usage type)

The time indicated by the hour and minute hand is shown in 24-hour format.

【Example】

Hour hand, date : Japan

24-hour hand : Japan

Japan : At 10:08 AM on 6th



## How to set the time and date (6R55)

The watch is provided with a date function and is so designed that the date changes once every 24 hours.

The date changes around 12 o'clock midnight. If AM/PM is not properly set, the date will change at 12 o'clock noon.

\* To adjust the date only on a day such as the next day after the completion of a month that has less than 31 days (February, April, June, September and November), please refer to "Date adjustment at the end of the month" → P.31.

### ⚠ CAUTION

Do not set the date between 9:00 p.m. and 1:00 a.m.  
Amending the date during this time period may cause problems such as the date failing to change the next day.

EN 28

**1 Make sure that the watch is working.**

\* To carry out the procedure, please make sure that the watch is in a working state. Please wind the mainspring when the watch is not working.

**2 Unlock the crown.**

\* "Screw down crown" → P.16

**3 Pull out the crown to the first click.****4 The date can be set by turning the crown.**

Turn it until the previous day's date appears.  
Ex.) To display the date as "7", then set this to "6".  
Turn the crown counterclockwise to set the date.

**■ Date adjustment at the end of the month**

It is necessary to adjust the date at the end of February and 30-day months.

Ex.) To adjust the date in the A.M. period on the first day of a month following a 30-day month

The watch displays "31" instead of "1". Pull out the crown to the first click.

Turn the crown counterclockwise to set the date to "1" and then push the crown back in to the normal position.

**⚠ CAUTION**

- Return the screw down crown fully to its original position.
- Avoid amending the date when the watch is displaying between 9 PM and 1 AM. Doing so may cause damage.

**5 Pull out the crown to the second click and set the time.**

Pull out the crown to the second click when the seconds hand is at the 12 o'clock position; the seconds hand stops on the spot.

Turn the crown to advance the hands until the date changes to the following date. The time is now set for the A.M. period. Advance the hands to set the correct time.

\* To set the time correctly, be sure to turn back the minute hand a little behind the desired time and then advance it to the exact time.

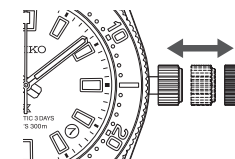
**6 Push the crown back in to the normal position in accordance with a time signal.**

The seconds hand immediately starts moving.

\* The telephone time signal service is helpful for setting the seconds hand exactly.

**7 Relock the crown.**

\* "Screw down crown" → P.16

**How to use the rotating bezel**

By setting the rotating bezel beforehand, the elapsed time since the start of an event can be measured.

**1 At the start of the event, for which you want to measure the elapsed time (for example, when you start diving), rotate the bezel so that the ▼ mark on the bezel is aligned with the minute hand.**

\* The rotating bezel is designed to rotate only counterclockwise.

Do not forcibly rotate it clockwise.  
["One-Way rotating bezel"] → P.33

Example: When you start diving at 10:10 am.

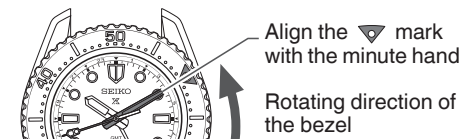
**2 Read the graduation on the rotating bezel to which the minute hand is pointing.**

The graduation on the rotating bezel to which the minute hand is pointing indicates the elapsed time.

Example: After 20 minutes has elapsed



\* The above illustration is provided as an example, therefore it may not be exactly the same as your watch.

**[One-Way rotating bezel]**

As the evaluation of the remaining air in your cylinder is based on the information of the elapsed time of the dive, the rotating bezel for a diver's watch is designed to rotate only counterclockwise, so that the watch is prevented from displaying the elapsed time shorter than it actually is.

**CAUTION**

Make sure that you check the correct remaining amount of air in your cylinder before diving. Use the display of the elapsed time by the rotating bezel only as a guide during diving.

**Daily care**

● **The watch requires good daily care**

- Do not wash the watch when its crown is in the extended position.
- Wipe away moisture, sweat or dirt with a soft cloth.
- After soaking the watch in seawater, be sure to wash the watch in clean pure water and wipe it dry carefully.  
Do not pour running water directly from a faucet onto the watch. Put some water into a bowl first, and then soak the watch in the water to wash it.  
\* If your watch is rated as "Non-water resistant" or "water resistant for everyday life", do not wash the watch. "Performance and type" → P.35

● **Turn the crown from time to time**

- In order to prevent corrosion of the crown, turn the crown from time to time.
- The same practice should be applied to a screw down crown.  
"Screw down crown" → P.16

**Performance and type**

The case back shows the caliber and performance of your watch

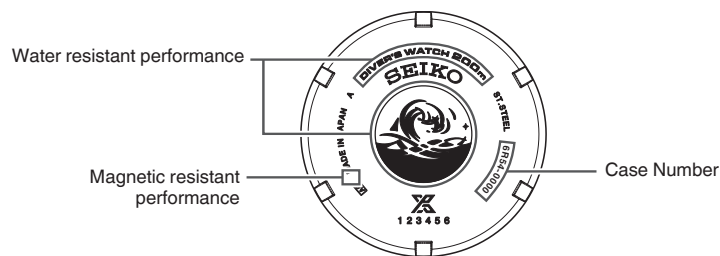

- **Water resistant performance**
- **Case Number**  
The number to identify the type of your watch.

- **Magnetic resistant performance**  
Please refer to P.37 and P.38.

\* The above illustration is provided as an example, therefore it may not be exactly the same as your watch.

**Lumibrite**

**If your watch has Lumibrite**

Lumibrite is a luminous paint that absorbs the light energy of sunlight and lighting apparatuses in a short time and stores it to emit light in the dark. For example, if exposed to a light of more than 500 lux for approximately 10 minutes, Lumibrite can emit light for 3 to 5 hours. Please note, however, that, as Lumibrite emits the light it stores, the luminance level of the light decreases gradually over time. The duration of the emitted light may also differ slightly depending on such factors as the brightness of the place where the watch is exposed to light and the distance from the light source to the watch.

\* In general, when coming from a place that is bright to a place that is dark, it takes human eyes some time to adapt to the darkness making it difficult to see objects initially. (Dark adaptation)

\* Lumibrite is luminous paint that stores and emits light, which is harmless to human beings and the environment, containing no toxic materials such as radioactive substances.

**<Brightness levels>**

| Condition   |                            | Illumination                     |
|---|----------------------------|----------------------------------|
| Sunlight  | Fine weather               | 100,000 lux                      |
|   | Cloudy weather             | 10,000 lux                       |
| Indoor (Window-side during daytime)                     | Fine weather               | More than 3,000 lux              |
|   | Cloudy weather             | 1,000 to 3,000 lux               |
|   | Rainy weather              | Less than 1,000 lux              |
| Lighting apparatus (40-watt daylight fluorescent light) | Distance to the watch: 1 m | 1,000 lux                        |
|   | Distance to the watch: 3 m | 500 lux (Average room luminance) |
|   | Distance to the watch: 4 m | 250 lux                          |

## Magnetic resistant performance

2

TO PRESERVE THE QUALITY OF YOUR WATCH

**Affected by nearby magnetism, a watch may temporarily gain or lose time or stop operating.**

Diver's watches feature magnetic resistant performance which is equivalent to or above JIS Class 1.

| ⚠ DANGER  |  |
|---|--|
| Indication on the case back   | Condition of use   |
| No indication   | Keep the watch more than 5 cm away from magnetic products.<br>(JIS level-1 standard) |
|  | Keep the watch more than 1 cm away from magnetic products.<br>(JIS level-2 standard) |

If the watch becomes magnetized and its accuracy deteriorates to an extent exceeding the specified rate under normal use, the watch needs to be demagnetized. In this case, you will be charged for demagnetization and accuracy readjustment even if it happens within the guarantee period.

### The reason why a watch is affected by magnetism

The built-in balance spring may be influenced by a strong external magnetic field.

EN 37

## Band

2

TO PRESERVE THE QUALITY OF YOUR WATCH

**The band touches the skin directly and becomes dirty with sweat or dust. Therefore, lack of care may accelerate deterioration of the band or cause skin irritation or stain on the sleeve edge. The watch requires a lot of attention for long usage.**

### ● Metallic band

- Moisture, sweat or soil will cause rust even on a stainless steel band if they are left for a long time.
- Lack of care may result in a rash or cause a yellowish or gold stain on the lower sleeve edge of shirts.
- Wipe off moisture, sweat or soil with a soft cloth as soon as possible.
- To clean the soil around the joint gaps of the band, wipe it out in water and then brush it off with a soft toothbrush.  
(Protect the watch body from water splashes by wrapping it up in plastic wrap etc.)  
Clean it off with a soft cloth.
- Because some titan bands use pins made of stainless steel, which has outstanding strength, rust may form in the stainless steel parts.
- If rust advances, pins may poke out or drop out, and the watch case may fall off the band, or the clasp may not open.
- If a pin is poking out, personal injury may result. In such a case, refrain from using the watch and request repair.

EN 39

## Examples of common magnetic products that may affect watches



Smartphone, cellular phone, tablet terminal  
(Speaker, magnet of cover)



AC adapter

Bag  
(With magnet buckle)



AC-powered shaver



Magnetic cooking device



Portable radio  
(Speaker)



Magnetic necklace

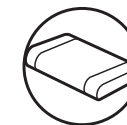

Magnetic health pillow

2

TO PRESERVE THE QUALITY OF YOUR WATCH

EN 38

### ● Polyurethane band

- A polyurethane band is susceptible to discoloration from light, and may be deteriorated by solvent or atmospheric humidity.
- Especially a translucent, white, or pale colored band easily adsorbs other colors, resulting in color smears or discoloration.
- Wash out dirt in water and clean it off with a dry cloth.  
(Protect the watch body from water splashes by wrapping it up in plastic wrap etc.)
- When the band becomes less flexible, have the band replaced with a new one. If you continue to use the band as it is, the band may develop cracks or become brittle over time.

### ● Silicone band

- As for material characteristics, the band is easily dirtied, and may be stained and discolored. Wipe off dirt with a wet cloth or cleaning tissue.
- Unlike bands of other materials, cracks may result in the band being cut. Take care not to damage the band with an edged tool.

2

TO PRESERVE THE QUALITY OF YOUR WATCH

EN 40

### ● Fabric band (Nylon/Polyester)

- Natural skin oil and dirt easily adhere to the band because it has a braided structure.
- Beware of fraying, damage, etc., caused by catching this product on other things.
- Note that the band may become discolored due to friction when wet with sweat or rain and that its color may transfer to other clothing.
- Beware of static electricity caused by friction with clothing material.
- If natural skin oil or dirt adheres to the band, gently wipe it off immediately with a dry cloth, etc.
- When drying the band, dry it in an airy place out of direct sunlight.
- The texture of the band may change if it is washed in water for a long time.
- After wearing in seawater, such as when diving, etc., rinse the band sufficiently to remove salt completely.
- Note that the band may discolor if it is left in direct sunlight.

|                                      |   |
|--------------------------------------|---|
| Notes on skin irritation and allergy | Skin irritation caused by a band may result from various factors such as allergy to metals or leathers, or skin reactions against friction on dust or the band itself.  |
| Notes on the length of the band      | Adjust the band to allow a little clearance with your wrist to ensure proper airflow.<br>When wearing the watch, leave enough room to insert a finger between the band and your wrist.  |

EN 41

- 3** While pressing the push button, lift up the clasp to release the buckle, and place the watch on your wrist.

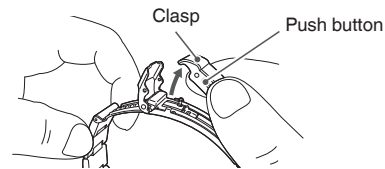

- 4** Close the clasp (4-1) first and then, the flap (4-2).

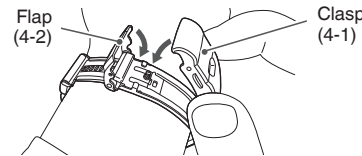

- 5** Hold both sides of the band to adjust the length of the slider until it fits snugly around your wrist.

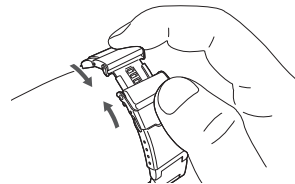

EN 43

## How to use the diver adjuster

If your watch's metallic band has the Diver Adjuster function, the length of the band can be easily adjusted.

It is very useful when you wear the watch over a wet suit or winter clothing.

- 1** Lift up the flap approximately 90° until it stands upright, and then press the flap down further approximately 20° and lightly hold it.

- When doing so, take care not to push the flap forcibly. Although you may feel slight resistance, doing this requires only a light force.

- 2** Lightly pull the band on the 6 o'clock side of the watch along the curved line of the band to pull out the slider.

- Doing this requires only a light force. Take care not to pull the band forcibly.
- The slider can be pulled out approximately 30 mm. Take care not to pull it out more than this limit.

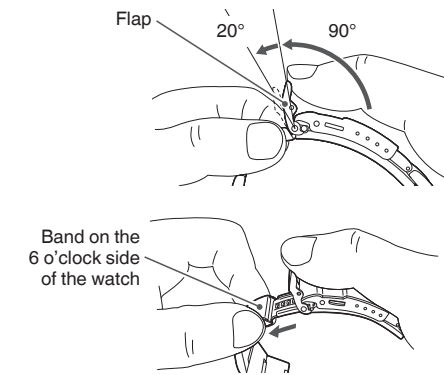

EN 42

## How to use the diver extender

If your watch's metallic band has the Diver Extender function, the length of the band can be easily adjusted.

It is very useful when you wear the watch over a wet suit or winter clothing.

- 1** Lift up the flap.

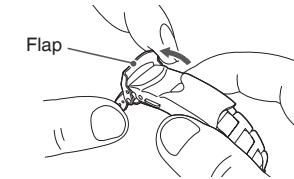

- 2** While pressing the push button, open the clasp.

- After opening the clasp, push the flap back to the normal position for safety's sake.

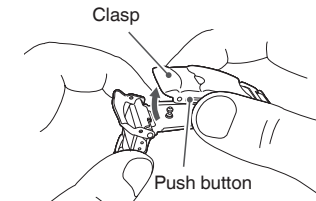

EN 44

### 3 Open the two-piece foldover portion of the Diver Extender in the direction of the arrow.

- Some force is required to open the foldover portion, and it will click when it is opened.

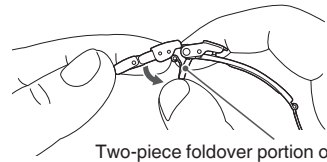

Two-piece foldover portion of the Diver Extender

### 4 Slide the upper cover of the Diver Extender in the direction of the arrow, and then, pull it up to extend the two-piece foldover portion to the full extent.

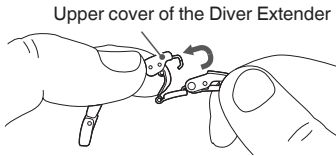

Upper cover of the Diver Extender

### 5 Place the watch on your wrist, and close the clasp (5-1) first and then, the flap (5-2).

- \* To fold up the Diver Extender, reverse the procedure above. When the two-piece folder portion of the Diver Extender is folded up completely, it also clicks in the same manner as when it is opened.

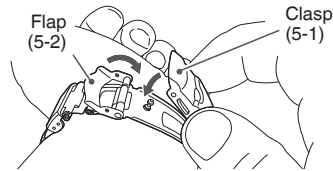

Flap (5-2) Clasp (5-1)

EN 45

1. As illustrated, position the watch and band with the buckle on the 12 o'clock side and pass the tip of the band, from the top, between the 12 o'clock side of the case and the spring bar.

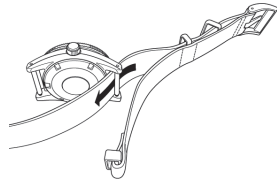

2. Pass the band across the back cover of the watch body and then between the 6 o'clock side of the case and the spring bar.

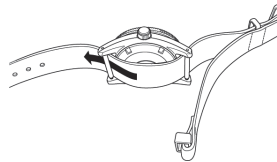

3. Pass the tip of the band through the fixed loop ① on the 6 o'clock side. The band is now attached to the case, and the watch is ready to be worn on your wrist.

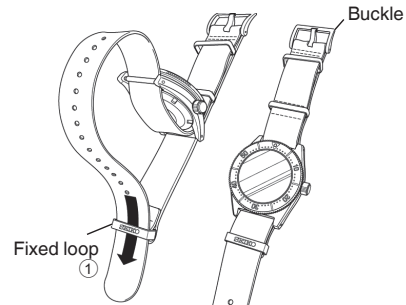

Fixed loop ①

Buckle

EN 47

## How to use the pull-through type band

This band has a mechanism that makes it easy to replace the band yourself. Please read the instructions carefully before replacing the band.

### ● Attaching a new band

First, remove the old band from the case.

- Ensure that the spring bars are securely attached to the case.
- Ensure that the buckle and fixed loops are fixed and attached securely to the band.

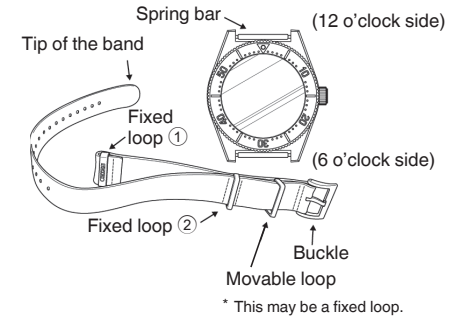

Spring bar (12 o'clock side)  
Tip of the band  
Fixed loop ①  
Fixed loop ②  
Buckle  
Movable loop  
\* This may be a fixed loop.

EN 46

### ● How to wear the band

1. Place the watch body on your wrist, pass the tip of the band through the buckle, and set the band to the appropriate length.
2. Pass the tip directly through both the movable loop and the fixed loop ②. As a guide, the band should be loose enough for a finger to fit between your wrist and the watch.
3. If the band is too long, fold and secure the tip of the band as illustrated.

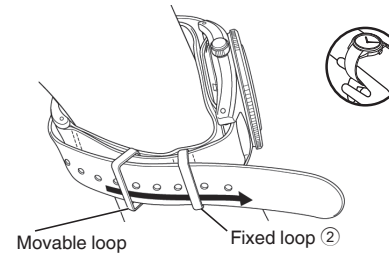

Movable loop

Fixed loop ②

- \* This may be a fixed loop.

EN 48

## After sales service

2

TO PRESERVE THE QUALITY OF YOUR WATCH

### ● Notes on guarantee and repair

- Contact the retailer from whom the watch was purchased or SEIKO CUSTOMER SERVICE CENTER for repair or overhaul.
- Within the guarantee period, present the certificate of guarantee to receive repair services.
- Guarantee coverage is provided in the certificate of guarantee. Read carefully and retain it.
- For repair services after the guarantee period has expired, if the functions of the watch can be restored by repair work, we will undertake repair services upon request and payment.

### ● Replacement with functional parts

- Please keep in mind that if original parts are not available, they may be replaced with substitutes whose outward appearance may differ from the originals.

EN 49

## Accuracy of mechanical watches

2

TO PRESERVE THE QUALITY OF YOUR WATCH

- The accuracy of mechanical watches is indicated by the “daily rate”.
- The accuracy of mechanical watches may not fall within the specified range of time accuracy because loss/gain changes according to the position of the watch, which is dependent on the conditions of use, such as the length of time during which the watch is worn on the wrist, arm movement, and whether the mainspring is wound up fully or not, etc.
- The loss/gain of mechanical watches is not measured by a daily rate, but by daily rates of one week or so.
- Accuracy variation according to temperature

The parts that compose the accuracy of mechanical watches are made of metals. It is well known that metals expand or contract depending on temperatures due to metal properties. This exerts an effect on the accuracy of the watches. Mechanical watches tend to lose time at high temperatures while they tend to gain time at low temperatures.

EN 51

### ● Inspection and adjustment by disassembly and cleaning (Overhaul)

- Periodic inspection and adjustment by disassembly and cleaning (overhaul) is recommended approximately once every 2 to 3 years in order to maintain optimal performance of the watch for a long time.
- The power transmission gear of the movement of this watch constantly receives force. To ensure that this mechanism works properly all the time, washing parts, changing oil, adjusting accuracy, checking functions and replacing consumable parts on a regular basis are important. The first overhaul after the purchase of your watch is particularly important for preserving long-time use of your watch. According to use conditions, the oil retaining condition of your watch mechanical parts may deteriorate, abrasion of the parts due to contamination of oil may advance or delay the time significantly, or the watch itself may stop. As the parts such as gasket may deteriorate, water resistant performance may be impaired due to intrusion of perspiration and moisture. Inspection and adjustment by disassembly and cleaning (overhaul) should be performed by the retailer from whom the watch was purchased, and who specifies “SEIKO GENUINE PARTS”. At this time, also request replacement of the gasket and the spring bar.
- When your watch is inspected and adjusted by disassembly and cleaning (overhauled), the movement of your watch may be replaced.

#### ⚠ CAUTION

Depending on the environment where a diver's watch is used, its inner parts or movement as well as its case or band may be affected. We recommend that you have your watch overhauled regularly once every 2 or 3 years.

EN 50

### ○ Mainspring wound condition and accuracy

In order to improve accuracy, it is important to regularly supply energy to the balance that controls the speed of the gears. The driving force of the mainspring that powers mechanical watches varies between when fully wound and immediately before it is unwound. As the mainspring unwinds, the force weakens. Relatively steady accuracy can be obtained by wearing the watch on the wrist frequently for the self-winding type and winding up the mainspring fully everyday at a fixed time to move it regularly for the wind-up mechanical type.

### ○ Effect of magnetism

When affected by a strong magnetism from outside, the mechanical watch may lose/gain time. The parts of the watch may become magnetized depending on the extent of the effect. In such a case, consult the retailer from whom the watch was purchased since the watch requires repair including demagnetizing.

EN 52

2

TO PRESERVE THE QUALITY OF YOUR WATCH

2

TO PRESERVE THE QUALITY OF YOUR WATCH

## Troubleshooting

2

TO PRESERVE THE QUALITY OF YOUR WATCH

| Troubles                    | Possible causes   | Solutions  |
|-----------------------------|---|--|
| The watch stops operating.  | The mainspring has not been wound.  | Wind up the watch as per "How to wind the mainspring" → (P.17), and set the time. If the watch still does not operate, consult the retailer from whom the watch was purchased.   |
|                             | The watch has been left in extremely high or low temperatures for a long time.  | Return the watch to a normal temperature so that it works accurately as usual, and then reset the time. The watch has been adjusted so that it works accurately when it is worn on your wrist under a normal temperature range between 5°C and 35°C. |
| The watch gains/loses time. | The watch has been left close to an object with a strong magnetic field.  | Accuracy cannot be recovered. Restoring the original accuracy requires demagnetization (repair). Consult the retailer from whom the watch was purchased.   |
|                             | You drop the watch, hit it against a hard surface, or wear it while playing active sports. The watch is exposed to strong vibrations. | If accuracy does not return after setting the time, consult the retailer from whom the watch was purchased.  |
|                             | The watch has not been overhauled for more than 3 years.  | Consult the retailer from whom the watch was purchased.  |

EN 53

| Troubles                             | Possible causes   | Solutions   |
|--------------------------------------|---|---|
| The date changes at 12 o'clock noon. | AM/PM is not properly set.  | Advance the hands by 12 hours.                          |
| Blur in the display persists.        | A small amount of water has got inside the watch due to deterioration of the gasket, etc. | Consult the retailer from whom the watch was purchased. |

\* For a solution to a problem other than listed above, contact the retailer from whom the watch was purchased.

2

TO PRESERVE THE QUALITY OF YOUR WATCH

EN 54

## Specifications

2

TO PRESERVE THE QUALITY OF YOUR WATCH

| Cal.                      | 6R54  | 6R55   |
|---------------------------|---|--|
| 1. Features               | 4 hands (Time display (Hour, minute and seconds hands), 24-hour hand), date display                               | 3 hands (Hour, minute and seconds hands), date display |
| 2. Vibrations per hour    | 21,600 vibrations/hour (6 vibrations/sec)   |  |
| 3. Loss/gain (daily rate) | +25 to -15 seconds at normal temperature range<br>Only if worn on the wrist in a temperature range of 5°C to 35°C |  |
| 4. Driving system         | Automatic winding type with manual winding mechanism  |  |
| 5. Duration               | Approx. 72 hours  |  |
| 6. Jewels                 | 24 jewels   |  |

\* The accuracy above is factory-adjusted.

\* Due to the characteristics of mechanical watches, any actual daily rate may not fall within the range of time accuracy specified above dependent on the conditions of use, such as the length of time during which the watch is worn on the wrist, temperature, arm movement, and whether the mainspring is wound up fully or not, etc.

EN 55