

## Table of Contents

1. Your Watch .....	9
2. Before Use .....	12
• Checking the Reference Position .....	14
3. Basic Watch Operations .....	16
<b>Radio Signal Reception</b>	
4. Radio Signal Reception .....	18
5. Poor Reception Areas .....	23
6. Display during Reception .....	24
7. Confirming Reception Status .....	26
8. Reception Area Guidelines .....	28
9. World City Display .....	34
10. Charge Level Display .....	40



<b>Operations in Each Mode</b>	
11. Changing Mode .....	42
12. Using Home Time and World Time.....	44
13. Using Daylight Saving Time.....	46
14. Setting the Time (TME).....	48
15. Setting the Calendar (CAL).....	52
16. Using the Timer (TMR).....	56
17. Using the Chronograph (CHR).....	60
18. Using the World Time Setting (WT-S).....	62
19. Using the World Time Alarm (AL-1 and 2).....	66
20. Using the Receive Setting (RX-S).....	68
21. LED Lights .....	72
22. Resetting Your Watch.....	72
23. Adjusting the Reference Position.....	74
<b>Using the Slide Rule Bezel .....</b>	<b>78</b>

<b>Solar Power</b>	
24. Solar Power Function .....	92
25. Characteristics of the Solar Powered Watch.....	94
A. Power Saving Function .....	96
B. Insufficient Charge Warning Function.....	98
C. Overcharging Prevention Function.....	99
D. Guide to Charging Time .....	100
E. Handling Your Solar Powered Watch.....	102
<b>Troubleshooting</b>	
Radio Signal Reception Function .....	104
Eco-Drive.....	108
<b>Precautions.....</b>	<b>110</b>
26. Specifications.....	116

Congratulations and Thank You for your selection of a CITIZEN Eco-Drive watch. To get the most out of your purchase, please be sure to read this manual and keep it on hand for reference.  
Once fully charged by exposure to light, your watch will give you years of enjoyment and reliability.

**Notice**

All repairs performed on this watch are to be performed at the CITIZEN. When desiring to have your watch repaired or inspected, please contact the Citizen Service Center either directly or through the store where you purchased your watch.

**Please use this watch after it has been sufficiently charged by exposure to light.**

If the second hand of the watch is moving at two-second intervals, this indicates the watch is insufficiently charged. To ensure proper operation, the watch should be fully charged by placing the watch under direct sunlight for about eight (8) hours. We recommend the watch keep a high charge level to ensure optimum operation. Charge your watch as indicated in “Guide to Charging Time” (p. 100).

## Part Names (1)

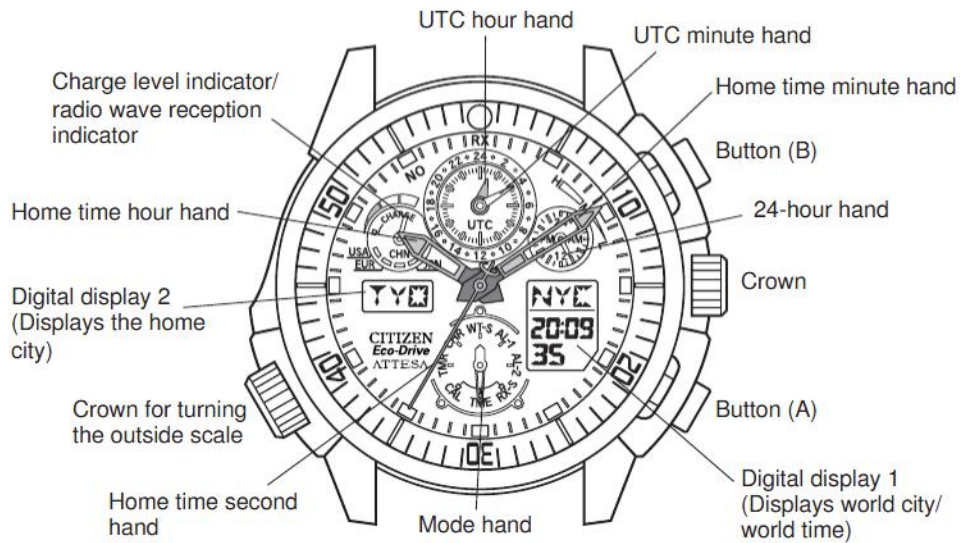

• The illustrations shown in this manual may differ from the actual watch you have purchased.

## Part Names (2): Digital Displays

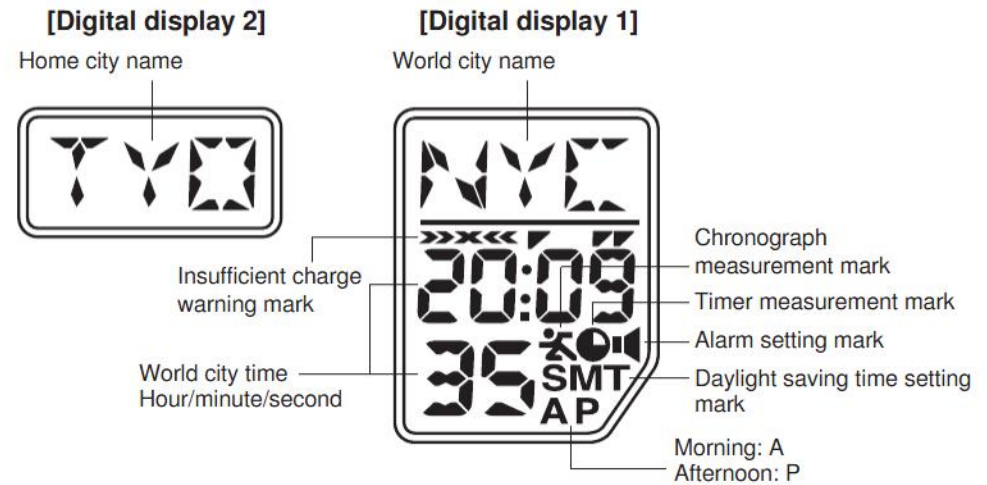

Note: To assist in the explanation, all parts of the digital display are shown in the illustration.

### Part Names (3): Radio Wave Reception Display

NO: Signal reception failed

RX: Reception standby

H, M, L: Reception level/  
reception status

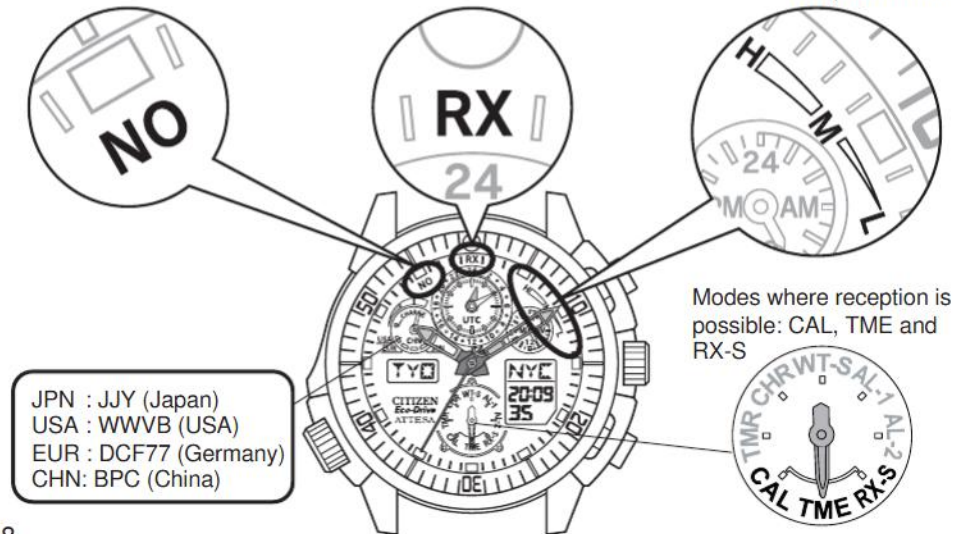

## 1. Your Watch

### World Time Eco-Drive Radio Controlled Watch

#### <Radio Signal Reception Function>

This watch is a radio controlled watch, which receives the standard time radio waves that are broadcast from radio wave transmitters in four regions, Japan, the USA, Europe (Germany) and China, and uses these waves to automatically correct the time and date. **(p. 18)**

- ◎ **Automatic reception:** The watch will automatically receive the radio wave up to three times a day, at 2 a.m., 3 a.m. and 4 a.m., and adjust the time and date accordingly. The 4 a.m. automatic reception can be changed to any time of the day.
- ◎ **On demand reception:** The radio wave can be received at any time of the day to adjust the time and date.

In the event that a radio signal cannot be received, the watch can be manually set and will operate keeping time within +/- 15 seconds per month.

### <World Time Function>

- © UTC (Coordinated Universal Time), the time and date of 43 cities (or regions) from around the world and one city (any can be set) can be displayed and easily called up. It is convenient when traveling overseas on business or vacation. Daylight saving time can also be set. (p. 46)

### <Solar Power Function>

This is a multi-functional Eco-Drive watch, which is equipped with a solar power function for powering the watch by converting light energy into electric energy.

- © **Charge level display function:** This function displays the charge level in four grades, to give an approximate indication of how much the secondary battery is charged. (p. 40)
- © **Power saving function:** The watch is equipped with two power saving functions. If the watch face is not exposed to light for 30 minutes or longer, all the LCD display sections turn off (Power saving 1). If the watch face is then not exposed to light for one week or longer, the hands are stopped in order to minimize the watch's power consumption (Power saving 2). (p. 96)

### Important Points Regarding Radio Wave Reception

There are two methods to receive radio signals during normal operation, Automatic and On Demand.

The internal unidirectional antenna may be weakened by geography or building structures, which may require the user to place the watch near a window.

When receiving radio waves:

- \* Remove the watch from your wrist
  - \* Face the 9:00 position of the watch towards a window
  - \* Place the watch on a stable surface
  - \* Do not move the watch during this process. Movement of the watch may cause incomplete reception. During radio reception, the second hand of the watch moves in reception level.
  - \* When reception is complete, the watch will return to movement at one-second intervals.
- Reception can take from about 2 minutes to a maximum of 15 minutes.

## 2. Before Use

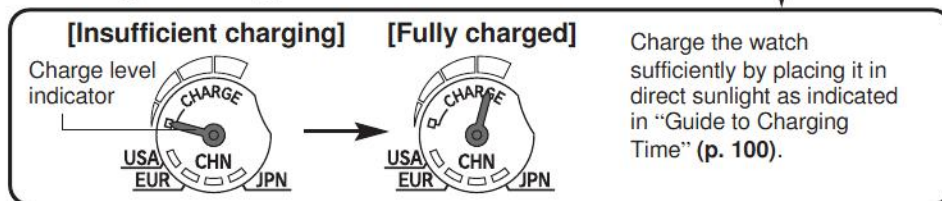
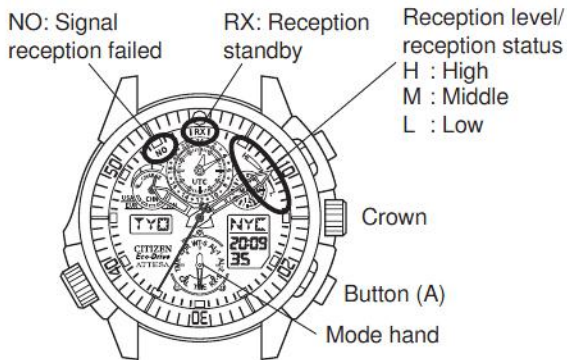

### Check the movement of the second hand.

The second hand is moving at 1-second intervals.

The second hand is moving at 2-second intervals or is stopped.

### Check the reception status.

- Pull out the crown to position 1.
- Turn the crown to align the mode hand with TME.
- Return the crown to the normal position.
- Press the lower right button (A) at the 4:00 position.

(p. 26)

The second hand indicates a reception status of H, M or L

**Your watch is correctly receiving the standard time radio wave. It is ready to use.**

The second hand indicates a reception status of NO

Refer to "On Demand Reception" (p. 20) to perform the radio wave reception.

If you are unable to receive radio waves, please inquire to the Citizen Service Center.

## [Checking the Reference Position]

**Before using the watch, confirm that the hands are aligned with “0”, similar to when setting weighing scales**

- ⦿ The reference position may become misaligned when the watch is exposed to strong magnetism, static electricity or impacts. Even if radio waves are received, the correct time will not be indicated unless the watch hands are aligned to the correct reference position. Check that the hands are properly aligned with “0”.

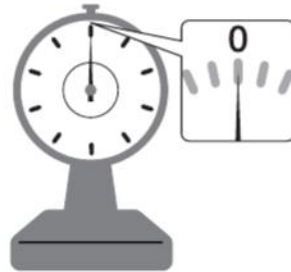

### Examples of magnetic products that can affect the watch.

- Health products (for example, medical necklaces and waist bands that have magnetic fields)
  - Refrigerators (magnetic part of the door)
  - Electromagnetic cookers
  - Bags (with magnet fasteners)
  - Mobile phones (speaker part)
- Keep the watch away from items similar to those above.

1. Pull the crown out to position 1 and turn to align the mode hand with CHR (chronograph mode).
2. Pull out the crown to position 2.
  - The hands will move rapidly, stopping at the reference position recorded in the watch memory.

### Correct reference positions

Charge level indicator: CHN  
UTC hour and minute hands: 12:00  
Hour, minute and second hands: 12:00:00  
24-hour hand: 12:00

3. If the reference position is correct, the check is now complete. Press the crown back into its normal position.
  - If a position is incorrect, refer to step 3 and later in “Adjusting the Reference Position” and adjust it to the correct position. (p. 74)

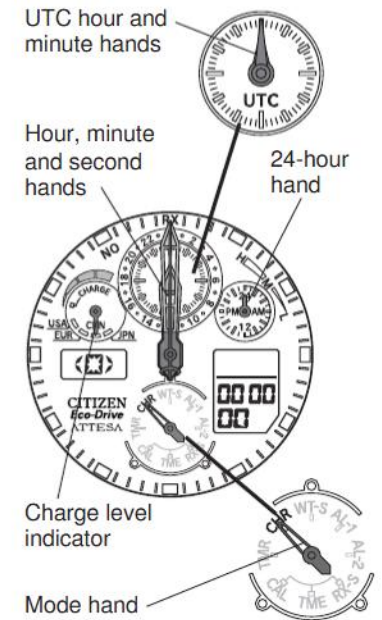

## 3. Basic Watch Operations

\* The watch receives the radio wave from the radio wave transmitter located in the home city's region.

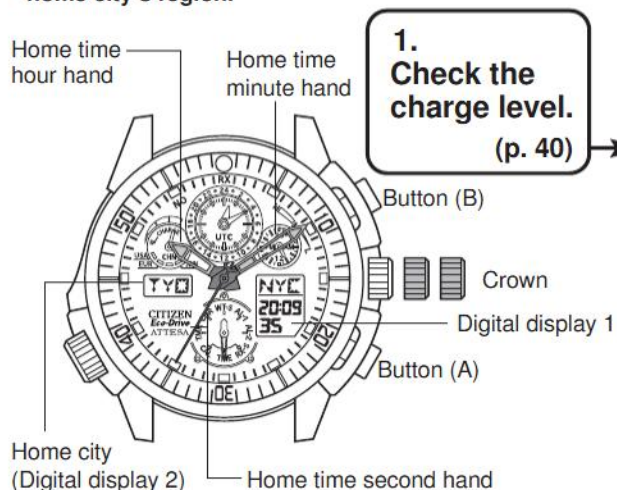

**1. Check the charge level.**  
(p. 40)

**2. Set the home city.**  
If the city in which you are situated is displayed in digital display 2,

- go to step 3
- (1) Pull out the crown to position 1 and turn to align the mode hand with TME.
  - (2) With the crown pulled out to position 1, press button (A) or (B) to call up the home city in digital display 1.
  - (3) Press button (A) and button (B) at the same time to display the home city in digital display 2.

**3. Set the home time.**

If the home time is correct,

go to step 4

- (1) Set the time manually (p. 48)
- (2) Set the time by receiving the radio wave (p. 20)

**Caution:**

**If the home city is set to a city that is outside the reception area, the radio wave cannot be received. Set the time manually.**

**4. Set digital display 1.**

The world time or date can be displayed on digital display 1. Also, the mode can be switched in order to use the alarm, timer or chronograph. (p. 42)

## ■ 4. Radio Signal Reception

Three types of radio signal reception are possible: automatic reception, on demand reception and recovery automatic reception.

There are three modes where reception is possible: time (TME), calendar (CAL) and receive set (RX-S). The watch cannot receive signals in any other mode.

Display the home city in digital display 2 when receiving the radio wave.

- Reception is not possible unless the crown is in the normal position.
- If the home city is “UTC”, reception is not possible.
- Reception is not possible during chronograph or timer measurement.
- The reception level may change depending on the surrounding environment. While referring to reception level (H, M or L), change the watch location, direction and angle to try to receive the radio wave.
- When the watch is receiving the radio wave, as a general rule, all of the hands will stop. To check the time, hold the lower right button (A) for 2 seconds to cancel radio wave reception. The hands will then return to the current time.
- Even while the radio wave is being received, the second hand will continue to rotate to align the minute hand with the current time. This shortens the time it takes to set the correct time.

### Automatic reception

- It is not necessary to operate buttons during automatic reception.
- The watch will automatically receive the radio wave every day at 2 a.m., 3 a.m. and 4 a.m.
- The 4 a.m. reception can be changed to any time of the day. (p. 68~71)
- Reception can be set to OFF. (p. 68~71)

### <Receiving the radio signals>

1. Remove the watch from your wrist and place on a stable surface in a location, such as near a window, from which radio waves can be easily received, pointing the 9:00 side (reception antenna position) in the direction of the radio wave transmitter.
2. The watch will automatically receive the radio wave every day at 2 a.m.

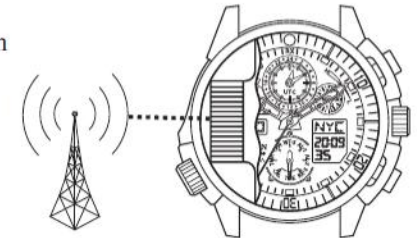

An antenna for receiving the radio signals is located inside the watch (on the 9:00 position).

### On Demand Reception (Manual Reception)

- Signals can be received at any time.

[Mode hand position when receiving]



#### <Receiving the radio signals>

1. Pull the crown out to position 1 and turn to align the mode hand with the CAL, TME or RX-S position.
2. Return the crown to the normal position.
3. Remove the watch from your wrist and place on a stable surface near a window where the radio signal can be easily received.

4. Point the 9:00 side of the watch in the direction of the radio wave transmitter, and hold down the lower right button (A) for more than 2 seconds. Release when the confirmation tone sounds and the second hand stops at RX. The second hand will then move to H, M or L, and reception will begin.
  - \* Do not move the watch during reception.
5. When the radio wave has been properly received, the second hand will automatically move from H, M or L to the time that was received, all the hands will be corrected, and the second hand will return to 1-second interval movement.
  - \* Reception can take a maximum of 15 minutes.

### Recovery Automatic Reception (Automatic Reception)

- If the watch stops due to insufficient charging, expose the watch to sunlight to recharge it. When the watch is recharged sufficiently, it will automatically receive the radio wave once.

- \* Regularly charge your radio controlled watch so it does not become insufficiently charged.  
The radio wave reception can be checked with “Confirming Reception Status”. (p. 26)

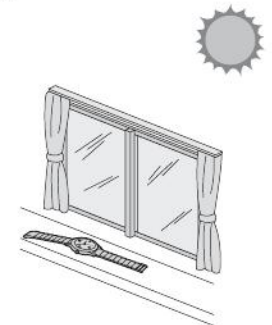

### <Storing Your Radio Controlled Watch>

If the watch has received insufficient light for charging or has been kept in a dark location for an extended period of time (one week or more), the Power Save Feature of the watch is activated and the hands of the watch stop. Even though the watch will not show movement, the correct time is kept in memory. When the watch is in the Power Save mode, it will continue to keep the correct time internally. In some instances, "Automatic Reception" may not be successful due to a weak signal reception. When resuming use of the watch after the power save mode has been activated for an extended period of time, you can cancel the Power Save function by placing the watch in light sufficient for charging and performing the "On Demand" reception process to correctly set the time and date. (Refer to **page 96** for information on the Power Save Function.)

## ■ 5. Poor Reception Areas

It may not be possible to receive radio waves under environmental conditions where reception is difficult or in areas susceptible to radio noise, such as those shown in the illustrations below. While referring to the reception level display, try to find a location with better reception.



◆ Inside reinforced concrete buildings or underground

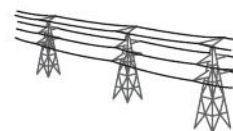

◆ Near high-tension electrical lines, railway overhead wires or communication facilities

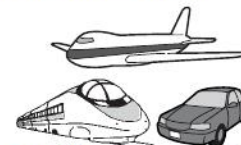

◆ Inside vehicles, including cars, trains and aero planes



◆ Near TVs, refrigerators, computers, fax machines and other home electronics or appliances



◆ Near cellular phones that are in use



◆ Extremely hot or cold locations

## 6. Display during Reception

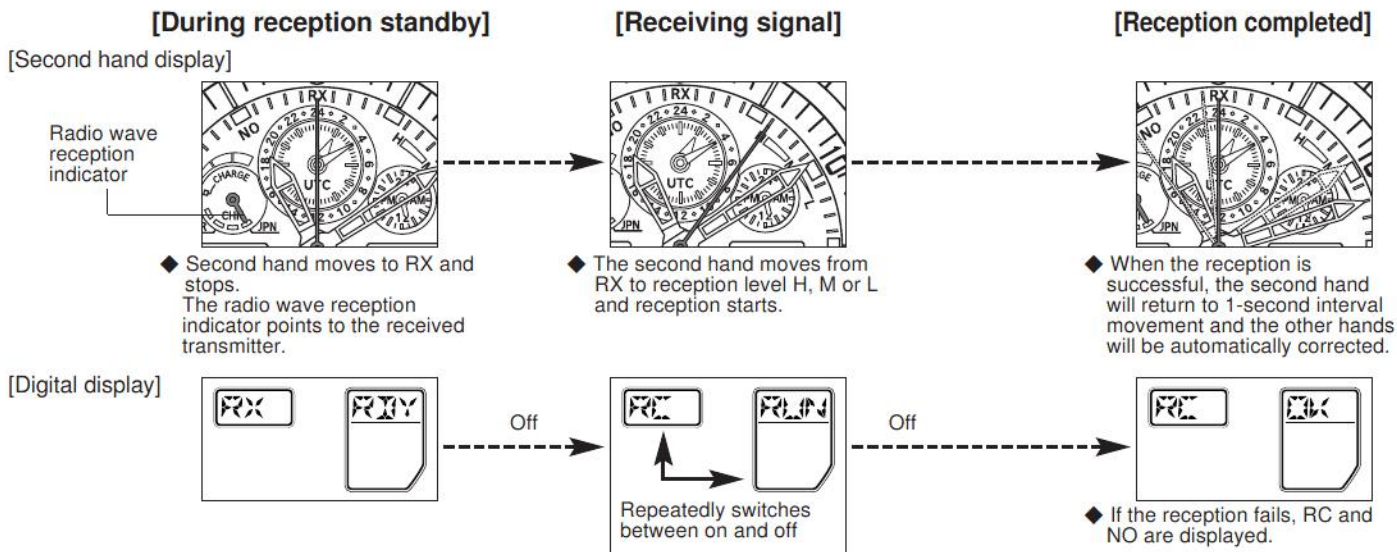

### <Time required for reception>

Reception can take from about 2 minutes to a maximum of 15 minutes, depending on factors such as the weather or noise. If the radio wave reception fails, the watch may return immediately to the normal display.

**[Caution]** During reception, the second hand may rotate once and show the reception level again. Do not move the watch until the second hand has returned to 1-second interval movement.

## 7. Confirming Reception Status

- The result of the radio wave reception can be confirmed.
- The daylight saving time setting status of the home city can be confirmed.

1. Pull the crown out to position 1 and set the mode to TME, CAL or RX-S.
2. Press the crown back into its normal position and press the lower right button (A) once to confirm the reception status. The second hand will move to H, M, L or NO.
  - The daylight saving time setting status for the home time is displayed on digital display 2 (flashes alternately between SMT and ON or OFF).
  - The radio wave reception indicator points to JPN, EUR, USA or CHN.
3. Press the lower right button (A) once.
  - The watch returns to the normal time display (1-second interval movement).
  - It also returns automatically to normal display if there are no operations for 10 seconds.

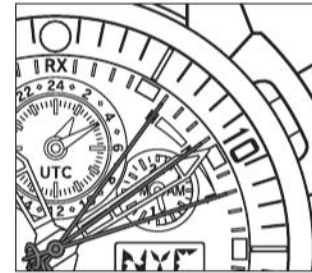
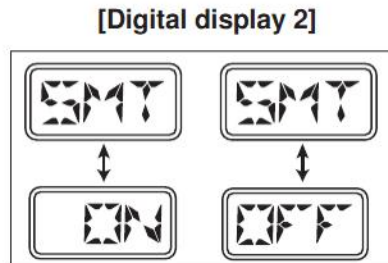

Reception level	Reception status
H	Radio wave reception environment was very good
M	Radio wave reception environment was good
L	Radio wave reception environment was not very good
NO	Signal reception failed

- \* The time display may shift slightly depending on the reception environment and internal watch processing even if radio waves are properly received.
- \* H, M and L indicate the reception status and are not connected to the performance of the watch.
- If NO is indicated, find a location or direction where the reception is better and perform on demand reception again. **(p. 20)**

## ■ 8. Reception Area Guidelines

This watch can receive standard time radio waves broadcast from Japan (two transmitters), the USA, Europe (Germany) and China.

The standard time radio wave to be received can be changed by selecting the city in another region.

The maps show the approximate reception areas. However, note that the radio wave condition could change due to factors including the weather (such as lightning) and changes in the season or sunrise/sunset time.

The reception area on the map is only guideline, and it may be difficult to receive the radio signal even within the areas indicated on the map.

	Standard time radio signal	Transmitter	Frequency
JPN	JJY Japan	Ohtakadoya-yama Standard Time Transmitter (Fukushima Transmitter)	40 kHz
		Hagane-yama Standard Time Transmitter (Kyushu Transmitter)	60 kHz
USA	WWVB USA	Fort Collins Transmitter, Denver, Colorado	60 kHz
EUR	DCF77 Germany	Mainflingen Transmitter, Southeast Frankfurt	77.5 kHz
CHN	BPC China	Shangqiu Transmitter, Henan	68.5 kHz

The standard time radio wave used by this radio controlled watch may be interrupted occasionally due to special circumstances at the radio wave transmitter. Even if reception of the standard time radio wave has failed, the watch will continue to be accurate to within  $\pm 15$  seconds per month.

JPN: JJY (Japan) Automatically selects one of the two transmitters  
Fukushima Transmitter: Radius of approximately 1,500 km from the transmitter  
Kyushu Transmitter: Radius of approximately 2,000 km from the transmitter

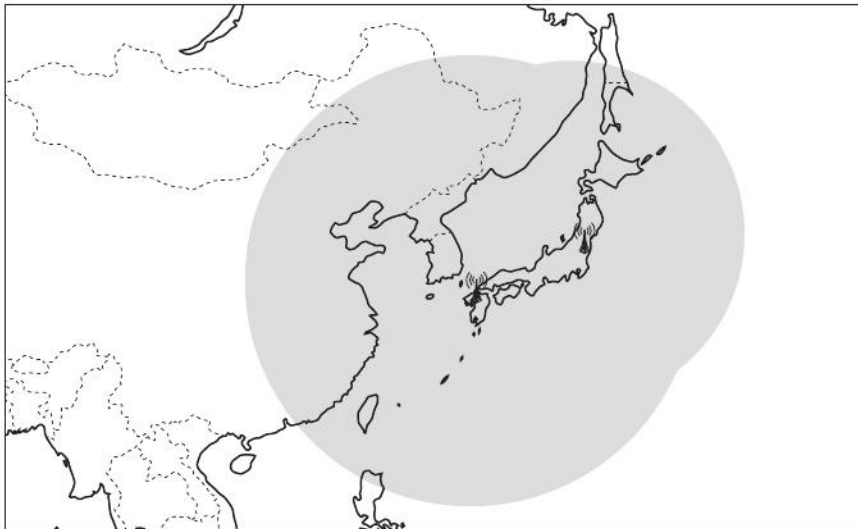

CHN: BPC (China) Shangqiu, Henan: Radius of approximately 1,500 km from the transmitter



USA: WWVB (USA) Fort Collins: Radius of approximately 3,000 km from the transmitter



EUR: DCF77 (Germany) Mainflingen: Radius of approximately 1,500 km from the transmitter



## ■ 9. World City Display

UTC (Coordinated Universal Time) and 43 cities (or regions) are registered in this watch in advance, and it is also possible to register one additional city. The time of each city can be called up and displayed.

- Press the upper right button (B) while the crown is in position 1 during TME mode or CAL mode to display in sequence from the top left to bottom right the city names shown in “Table of UTC Time Differences” (p. 36), and press the lower right button (A) to display the city names in sequence from the bottom right to top left.

### UTC: Coordinated Universal Time

This is the time of an atomic clock that is used as the global standard (= international atomic time). It uses leap seconds to correct deviations in time systems that are based on the rotation of the Earth (universal time).

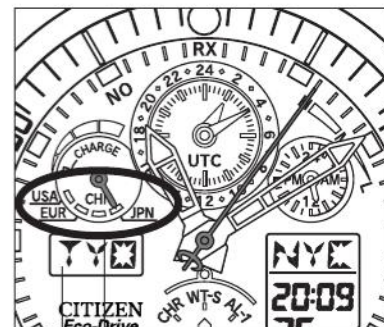

Digital display 2

### [Cities and the standard time radio wave assignment]

- The received standard time radio waves shown in “Table of UTC Time Differences” are assigned one of the following four radio wave transmitters, in accordance with the home city in digital display 2.

### [Standard time radio wave assignment]

JPN : JJY (Japan)  
 USA : WWVB (USA)  
 EUR : DCF77 (Germany)  
 CHN : BPC (China)

- Radio wave transmitters are assigned even for countries and regions outside the reception area.
- For regions that are assigned Japan’s standard time radio wave (JJY), either the Fukushima transmitter or Kyushu transmitter is selected automatically for reception, whichever is easier to receive.

### [Table of UTC Time Differences]

Set to TME mode and press the upper right button (B) repeatedly while the crown is in position 1 to display in sequence in digital display 1 the table's city names from top to bottom, and press the lower right button (A) to display in sequence the city names from bottom to top.

- Radio waves are only received from the assigned transmitters.  
(Example: When TYO is displayed in digital display 2, radio waves other than the Japan radio wave cannot be received.)

Refer to the "Received standard time radio wave" item for the radio wave that is received in each city.

"EUR" → Europe radio wave, "CHN" → China radio wave, "JPN" → Japan radio wave, "USA" → USA radio wave

\* National governments may change the period of daylight saving time, the time difference, or the names of cities.

Display	City name	Time difference	Received radio wave transmitter	Display	City name	Time difference	Received radio wave transmitter
UTC	Coordinated universal time	0	---	CAI	Cairo	+ 2	EUR
				ATH	Athens	+ 2	EUR
LON	London	0	EUR	JNB	Johannesburg	+ 2	EUR
MAD	Madrid	+ 1	EUR	MOW	Moscow	+ 3	EUR
PAR	Paris	+ 1	EUR	RUH	Riyadh	+ 3	EUR
ROM	Rome	+ 1	EUR	THR	Tehran	+ 3.5	EUR
BER	Berlin	+ 1	EUR	DXB	Dubai	+ 4	EUR





Display	City name	Time difference	Received radio wave transmitter	Display	City name	Time difference	Received radio wave transmitter
KBL	Kabul	+ 4.5	EUR	TYO	Tokyo	+ 9	JPN
KHI	Karachi	+ 5	CHN	ADL	Adelaide	+ 9.5	JPN
DEL	Delhi	+ 5.5	CHN	SYD	Sydney	+ 10	JPN
DAC	Dhaka	+ 6	CHN	NOU	Noumea	+ 11	JPN
RGN	Yangon	+ 6.5	CHN	AKL	Auckland	+ 12	JPN
BKK	Bangkok	+ 7	CHN	SUV	Suva	+ 12	JPN
SIN	Singapore	+ 8	CHN	MDY	Midway	- 11	USA
HKG	Hong Kong	+ 8	CHN	HNL	Honolulu	- 10	USA
BJS	Beijing	+ 8	CHN	ANC	Anchorage	- 9	USA
TPE	Taipei	+ 8	JPN	YVR	Vancouver	- 8	USA
SEL	Seoul	+ 9	JPN	LAX	Los Angeles	- 8	USA

Display	City name	Time difference	Received radio wave transmitter	Display	City name	Time difference	Received radio wave transmitter
DEN	Denver	- 7	USA	FEN	Fernando de Noronha	- 2	EUR
MEX	Mexico City	- 6	USA				
CHI	Chicago	- 6	USA	PDL	Ponta Delgada	- 1	EUR
NYC	New York	- 5	USA	HOM	Home (Time difference set by user)	Any	Depends on the time difference
YMQ	Montreal	- 5	USA				
SCL	Santiago de Chile	- 4	USA				
RIO	Rio de Janeiro	- 3	USA				

## 10. Charge Level Display

- The charge level (approximate) is displayed in four grades to show how much the secondary battery is charged.
- The charge level indicator points to the middle of each grade.
- Use the charge level display as a guideline when wearing your watch. We recommend that you regularly check the charge level and keep it at level 2 or above.

### [Checking the charge level display]

Level	Level 0	Level 1	Level 2	Level 3
Charge level display				
Remaining time (approximate)	About 3 days	About 3 to 20 days	About 20 to 130 days	About 130 to 180 days
	Insufficient charging. Recharge the watch immediately. The insufficient charge warning is activated at this level.	The charging level is rather low. Recharge the watch.	The charge condition is good. The watch can be used normally at this level.	The watch is sufficiently charged. The watch is fully charged and can be used normally at this level.

#### [Caution]

When the charge level indicator points at level 0, the secondary battery is very low. The second hand moves at 2-second intervals, and the  in the digital display. After about three days the battery will run out and the watch will stop. Be sure to recharge the watch before this condition is reached.

## 11. Changing Mode

This watch has eight modes: time (TME), calendar (CAL), timer (TMR), chronograph (CHR), world time set (WT-S), alarm 1 (AL-1), alarm 2 (AL-2) and receive set (RX-S).

1. Pull the crown out to position 1 (mode switching position).

- The home city and (M) are displayed alternately on digital display 2 to show that the mode switching status has been entered.

2. Turn the crown to the right or left to align the mode hand with the desired mode.

3. Return the crown to the normal position.

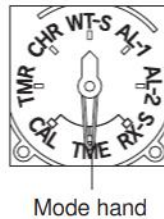
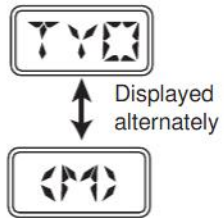
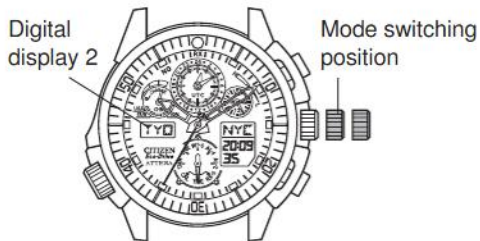

### <Mode names>

\* Crown in position 1

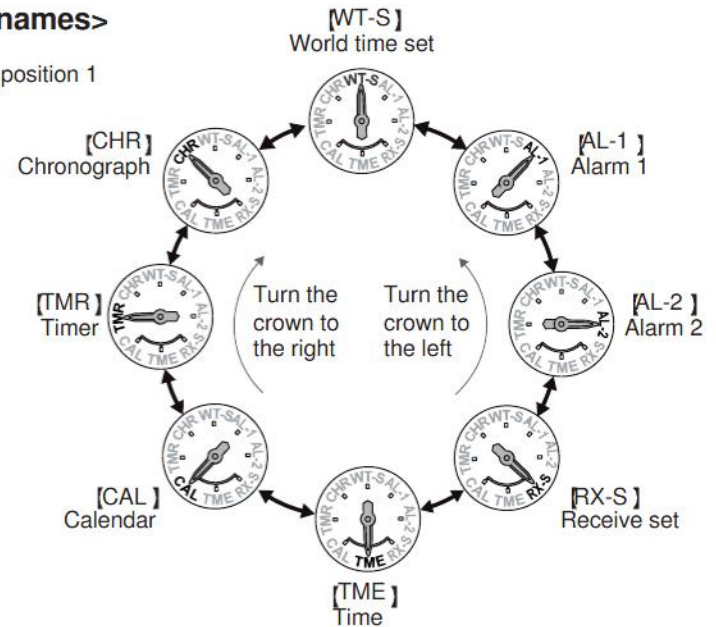

## 12. Using Home Time and World Time

- When going to a country or region in a different time zone when on business or vacation, the destination home time can be easily displayed by switching the home time and world time.
- \* Switching can only be performed during the time mode (TME) or calendar mode (CAL).

### <Switching between home time and world time>

#### Example: Going to New York from Los Angeles

When Los Angeles time “10:09 a.m.” is displayed for the home time (hand display) and New York time “P1:09” is displayed for the world time (digital) (NYC is displayed in digital display 1, and LAX is displayed in digital display 2)

- Pull the crown out to position 1 (mode switching position).
  - Turn the crown to enter time mode (TME) or calendar mode (CAL).
  - The home city LAX and (M) are displayed alternately on digital display 2, to show that the mode switching status has been entered.
- Press button (A) and button (B) at the same time.
  - A confirmation tone sounds, and the Los Angeles and New York city names and times are switched.
- Turn the crown to return to the original mode.
- Return the crown to the normal position to complete the operation.

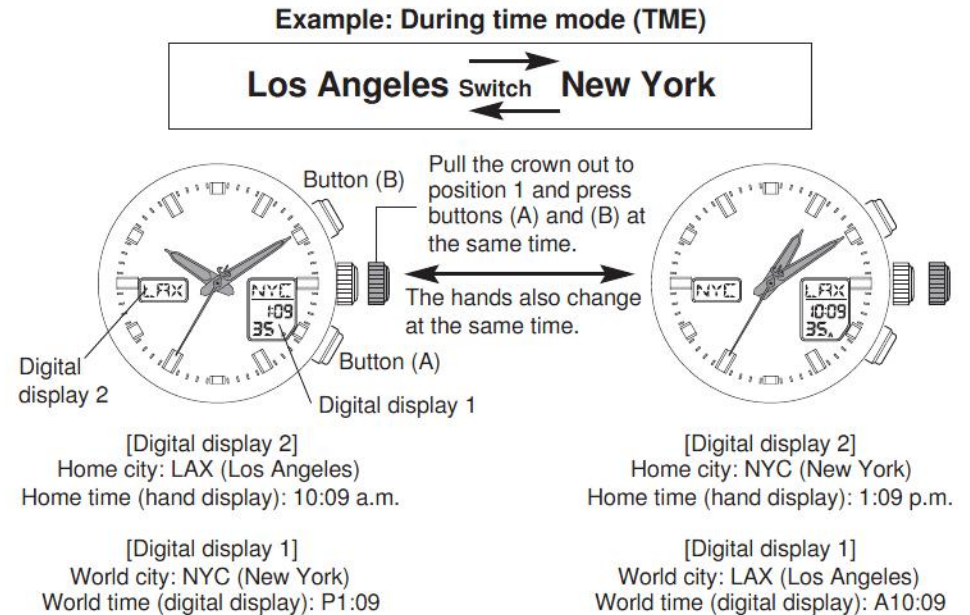

## ■ 13. Using Daylight Saving Time

### [What is daylight saving time?]

This is a time system where the clocks are put forward an hour during the summer, when the daylight hours are longer.

Whether or not the system is used and the length of use differs between countries and regions.

### ◎ To change automatically to daylight saving time by receiving the radio wave

- By setting the daylight saving time reception setting in RX-S mode to AU, when the radio wave is received, the time will be automatically updated with the daylight saving time information.

\* The home city must be a city within the reception area.

\* The timing for changing to daylight saving time can vary depending on the city or region. There may be cases when the time is not changed on the appropriate date.

### [Setting the daylight saving time]

	Change automatically with radio wave reception		Manually set the daylight saving time	
	RX-S	TME/WT-S	RX-S	TME/WT-S
To activate the daylight saving time	AU	Either ON or OF may be set.	mA	ON
To deactivate the daylight saving time	AU		mA	OF

\* Refer to the explanations for each mode for details on the operations.

## ■ 14. Setting the Time (TME)

(The time is corrected using the digital display)

- The time can be set manually in countries or regions where the radio wave cannot be received.
- To set the time, call up the city whose time you want to correct in digital display 1. The home time (hour/minute/second hands) cannot be corrected directly.
- It is possible to change the daylight saving time setting in TME mode.

### <Correcting the time>

1. Pull the crown out to position 1 and turn to align the mode hand with TME (time mode).
2. Press button (A) or (B) to call up the city name whose time you want to correct.
  - When setting the home city time (hour, minute, second hands), switch the home city and world city before correcting the time. (Refer to “Switching between home time and world time” p. 44)
3. Pull the crown out to position 2 to enter the time correction status.
  - The second hand will move to the 12:00 position and stop.
  - The home city display of digital display 2 will go off.
  - The correction status for the daylight saving time setting is entered and ON or OF flashes. (There is no daylight saving time ON or OF setting for UTC.)
  - Press the lower right button (A) to switch between setting (ON) and canceling (OF) the daylight saving time.
  - When daylight saving time is set, the time moves forward by one hour.
  - Each time the upper right button (B) is pressed, the correction location changes. The new correction location will begin flashing.
4. Press the upper right button (B) to enter the second correction status.
  - Press the lower right button (A) to return to 0 seconds.
5. Press the upper right button (B) to enter the minute correction status.
  - Turn the crown to correct the time. Turn to the right to move forward and to the left to move back.
  - Turn the crown continuously to move quickly. To stop, turn the crown to the left or right.

6. Press the upper right button (B) to enter the hour correction status.
  - Turn the crown to correct the time. Turn to the right to move forward and to the left to move back.
  - Turn the crown continuously to move quickly.
7. Press the upper right button (B) to enter the 12H/24H correction status.
  - Press the lower right button (A) to switch between the 12-hour clock and 24-hour clock.
  - This setting is applied even in other modes.
8. Return the crown to the normal position to complete the operation.
  - When the home time is corrected, the analog time, which is linked to the digital time, is also corrected.

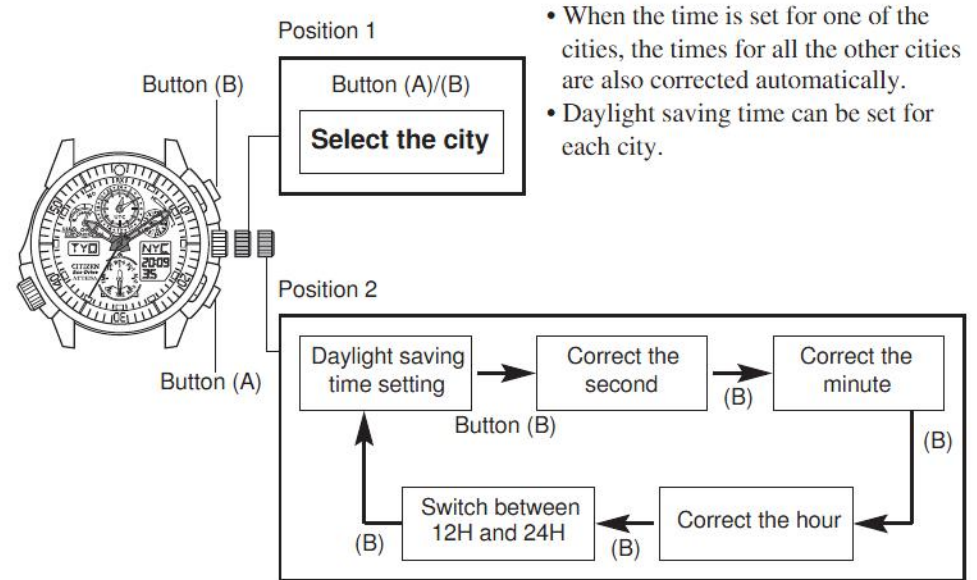

## ■ 15. Setting the Calendar (CAL) (The date is corrected using the digital display)

- The date can be set manually in countries or regions where the radio wave cannot be received.
- In the same way as for “Setting the Time”, to adjust the date of the home city, call up the city whose date you want to correct in digital display 1.

### <Correcting the date>

1. Pull the crown out to position 1 and turn to align the mode hand with CAL (calendar mode).
2. Press button (A) or (B) to call up the city name whose date you want to correct.
3. Pull the crown out to position 2 to enter the date correction status.
  - The month display flashes and the home city display and day display will go off.

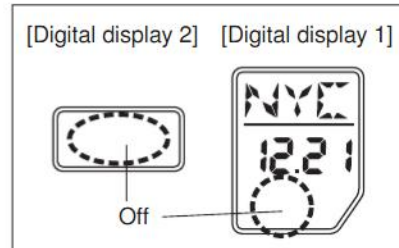

4. Each time the upper right button (B) is pressed, the correction location changes. The new correction location will begin flashing.
  - The correction location changes in the following sequence: month → date → year.
5. Select the correction location and turn the crown to correct the time.
  - Turn the crown continuously to move quickly.
  - To stop, turn the crown to the left or right.
  - When the year, month and date are set, the day is corrected automatically.
6. Press the crown back into its normal position.

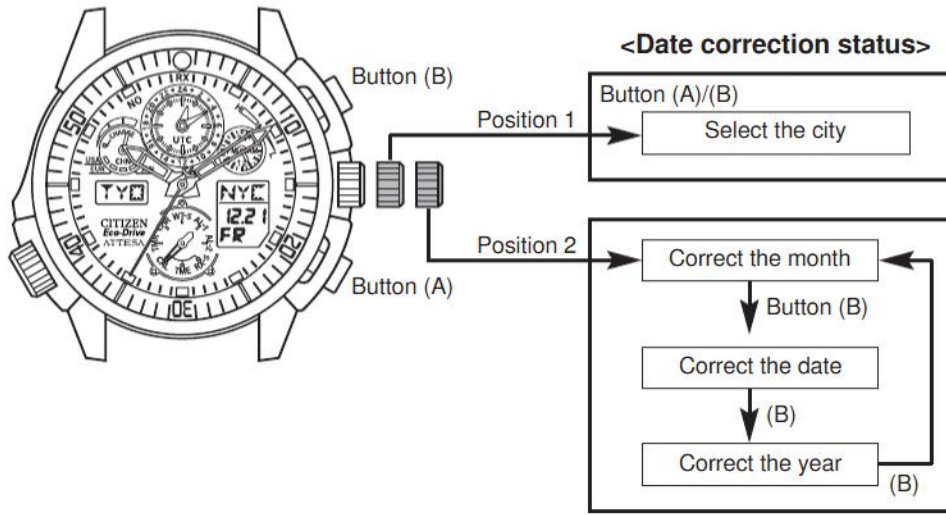

- When the date is set for one of the cities, the dates for all the other cities are also corrected automatically.
- The year can be set between 2000 and 2099.
- When the year, month and date are set, the day is corrected automatically.
- If a date that does not exist is set (for example, February 30), when the watch returns to the normal display, it automatically displays the first day of the next month.

## ■ 16. Using the Timer (TMR)

- The timer can be set from 1 minute up to 99 minutes, in 1-minute units. After the end of measurement, the time-up tone sounds for about 5 seconds and the watch returns to the timer initial setting status. (Auto return function)
- Press the lower right button (A) during measurement to return to the initial set time and start measurement again. (Flyback function)
- Radio waves cannot be received during timer measurement.

### <Setting the timer>

1. Pull the crown out to position 1 and turn to align the mode hand with TMR (timer mode).
2. Pull the crown out to position 2 to enter the timer setting status.
  - SET is displayed in digital display 2 and the minute display in digital display 1 flashes.

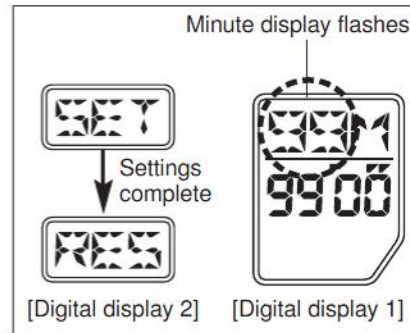

3. Turn the crown to set the time.
  - Turn to the right to increase the time and turn to the left decrease the time.
  - Turn the crown continuously to move quickly.
  - To stop, turn the crown to the left or right.
4. After completing the settings, return the crown to the normal position.
  - Digital display 2 changes to RES (reset).

### <Using the timer>

1. A confirmation tone will sound each time you press the upper right button (B) to start and stop the measurement.
  - RUN (run) is displayed in digital display 2 during measurement, and STP (stop) is displayed when the timer is stopped. The measurement mark comes on during measurement.
2. Press the lower right button (A) during measurement to return to the initial set time and start measurement again.(Flyback function)
3. Press the lower right button (A) while the timer is stopped to return to the initial set time.
  - Digital display 2 changes to RES.

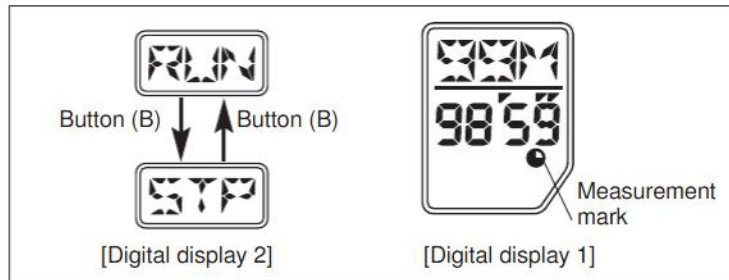

4. When the time is up, END is displayed in digital display 2 and the time-up tone sounds for 5 seconds.
    - To stop the time-up tone, press button (A) or (B).
    - RES is displayed on digital display 2 and the timer returns to the initial set time.
- \* The measurement continues even if the watch is switched to a different mode during measurement.
- \* The time-up tone does not sound unless the crown is in the normal position.

## 17. Using the Chronograph (CHR)

- The chronograph can display times up to 23 hours 59 minutes and 59.99 seconds.
- After it exceeds 24 hours, the measurement stops and the chronograph returns automatically to the reset status.
- Radio waves cannot be received during chronograph measurement.

### <Using the chronograph>

1. Pull the crown out to position 1 and turn to align the mode hand with CHR (chronograph mode).
2. Return the crown to the normal position.
3. A confirmation tone will sound each time you press the upper right button (B) to start and stop the measurement.
4. Press the lower right button (A) during measurement to display a split time for 10 seconds. After the 10 seconds, the watch returns to the measurement status. (Auto return function)
  - The measurement mark is displayed during measurement and during the split display.
  - The SPL display flashes during the split time display.
5. Press the lower right button (A) while the chronograph is stopped to return to the chronograph reset status.

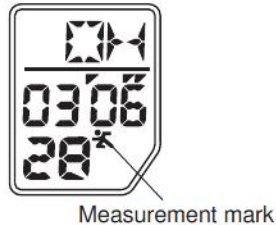
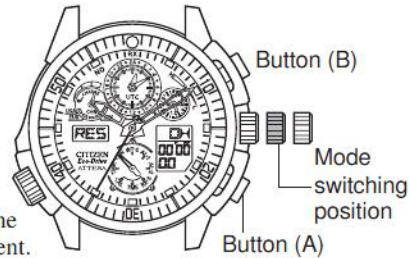

- While the chronograph is being operated, the display of digital display 2 changes as follows.

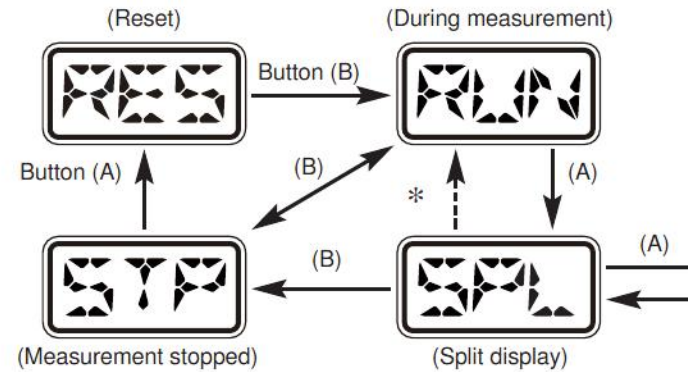

- \* If there are no button (A) or (B) operations for 10 seconds, the watch returns to the measurement status.
- The measurement continues even if the watch is switched to a different mode during measurement.

## 18. Using the World Time Setting (WT-S)

- Daylight saving time can be set for each city. (Cannot be set for UTC)
- Whether show or hide each city (44 cities other than UTC) can be set.
  - \* Using this function, it is easy to call up and display the cities from each mode. (Zone set function)
  - \* If a city is set to not display, it cannot be displayed from other modes.
- Any time difference in units of 15 minutes can be set for HOM (user setting city).

### [NOTE]

Even if daylight saving time is set for each city in WT-S mode (ON or OF (off)), if AU is set in RX-S mode, priority is given to the daylight saving time setting in RX-S mode, with ON automatically switched to OF or OF automatically switched to ON. (Users in countries or regions without a radio wave transmitter should make sure that the start date and finish date of daylight saving time are accurate.)

### <“Daylight saving time” and “Show/hide city” settings>

1. Pull the crown out to position 1 and turn to align the mode hand with WT-S (world time set mode).
2. Pull the crown out to position 2 to enter the world time correction status.
  - Digital display 2 goes off, digital display 1 enters the daylight saving time setting status for the city that is displayed, and ON or OF flashes.
  - The initial settings are all OF (canceled).

3. Press the lower right button (A) to switch between daylight saving time ON (set) and OF (canceled).
  - When daylight saving time is set, the time will move forward by one hour.
  - Turn the crown to set the daylight saving time for other cities. Turn to the right to change in the direction of cities with more of a time difference, and turn to the left to change in the direction of cities with less of a time difference.
4. Press the upper right button (B) to switch between the show/hide setting status for the city.
  - SET (show) or OFF (hide) flashes.
  - The initial settings are all SET (show).
5. Press the lower right button (A) to select SET or OFF.
  - Press the lower right button (A) to switch between displaying SET and OFF, and then select the desired setting.
  - Turn the crown to set other cities.
6. Press the crown back into its normal position.

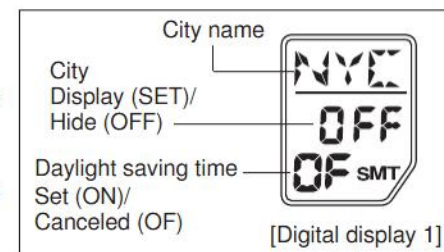
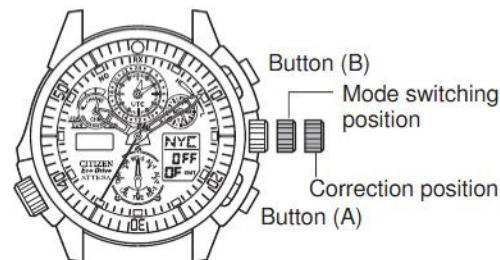

### <Setting the desired time difference>

- Any time difference can be set for HOM (user setting city), in intervals of 15 minutes from the UTC time.
- The radio wave received at HOM will be from the transmitter assigned to the city that has the most similar time difference with UTC.

1. Pull the crown out to position 1 and turn to align the mode hand with WT-S (world time set mode).
2. Pull the crown out to position 2 to enter the world time correction status.
3. Turn the crown to call up HOM for the world city.
  - ON or OF flashes and the watch enters the daylight saving time setting status.

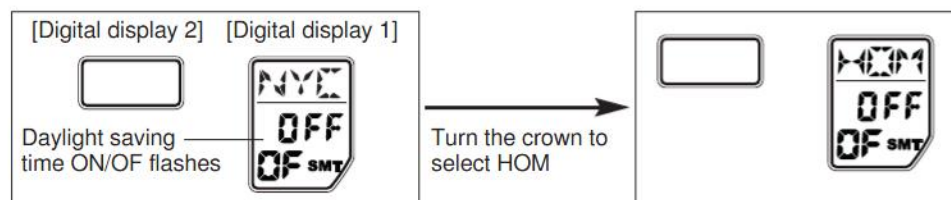

4. Press the upper right button (B) twice to enter the time difference setting status.
  - Each time you press the upper right button (B), the “Daylight saving time ON/OFF”, “City display SET/OFF” and “Time difference setting” correction location changes. The new correction location will begin flashing.
5. Turn the crown to set the time difference.
  - Turn to the right to display (+) in the world time section and display time differences with UTC in 15-minute units in the time display section.
  - Turn to the left to display (-) in the world time section and display time differences with UTC in 15-minute units in the time display section.
  - Turn the crown continuously to change the time difference quickly. Turn crown to the right or left to stop the quick movement.
6. Press the crown back into its normal position.
  - \* If the time difference is not set, the HOM city will not be displayed regardless of whether the display is set to SET or OFF.

### [Time difference setting status]

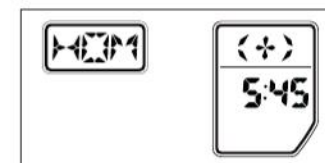
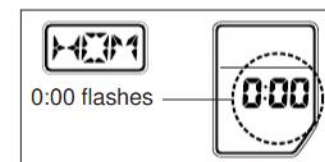

When a time difference of +5 hours 45 minutes with UTC is set

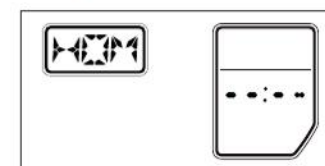

## 19. Using the World Time Alarm (AL-1 and 2)

- An alarm can be set for the set city time.
- Once a day, the alarm will sound for 15 seconds when it reaches the set time. To stop the alarm, press button (A) or (B).
- The sound of the alarm is different for alarm 1 and alarm 2, but the setting method is the same.

### <Setting the alarm time>

1. Pull the crown out to position 1 and turn to align the mode hand with AL-1 or AL-2 (alarm mode).
2. Pull the crown out to position 2 to enter the alarm correction status.
  - The set city is called up and ON or OF flashes.
3. Press the lower right button (A) to set alarm ON (set) or OF (canceled).
  - Press the lower right button (A) to switch between ON and OF.
  - The alarm mark comes on when ON is set.
4. Each time the upper right button (B) is pressed, the display flashes and the correction location changes.



- The correction location changes in the following sequence: Alarm ON/OFF → City name → Alarm: Hours → Alarm: Minutes.
  - City name: Turn the crown to select the city.
  - Alarm hours/minutes: Turn the crown to the right to move the time forward and to the left to move the time back.  
Turn the crown continuously to move quickly. To stop, turn the crown to the left or right.
5. Press the crown back into its normal position.

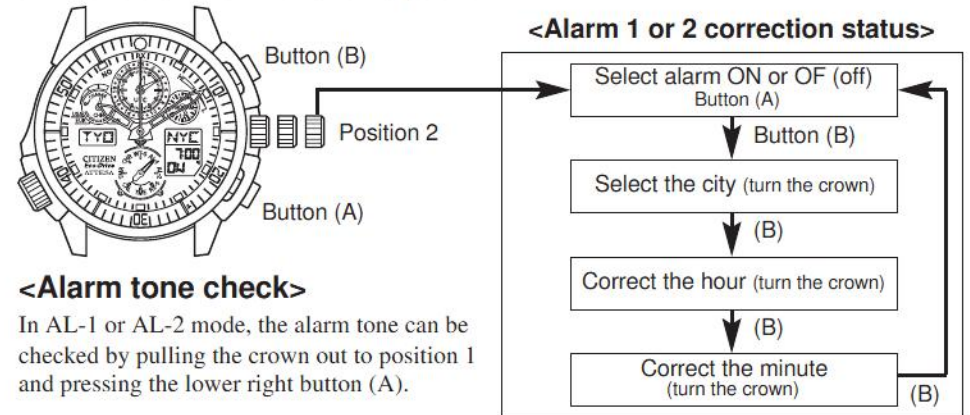

### <Alarm tone check>

In AL-1 or AL-2 mode, the alarm tone can be checked by pulling the crown out to position 1 and pressing the lower right button (A).

## ■ 20. Using the Receive Setting (RX-S)

### [Daylight saving time reception setting]

- Select whether to update the time with the daylight saving time from the received radio wave. Refer to “Using Daylight Saving Time” (p.46) for details on daylight saving time.

AU (Auto): The time is updated with the daylight saving time from the received radio wave.

- \* The timing for changing to daylight saving time can vary depending on the city or region. There may be cases when the time is not changed on the appropriate date.
- \* If AU is selected, when daylight saving time data is received for the daylight saving time setting of the home city, the setting is changed to ON, and when no daylight saving time data is received, the setting is changed to OF (off).
- \* When the radio wave of the area is received, daylight saving time for the corresponding city is automatically updated to ON or OF (off). Refer to the “Received radio wave transmitter” in “Table of UTC Time Differences” on **page 36** for the radio wave that is received in each city.

mA (Manual): The time is not updated with the daylight saving time from the received radio wave.

### [Automatic reception setting]

- Set the operating conditions for automatic reception.
  - MAN (Manual): The 4 a.m. automatic reception can be changed to any time of the day for the home time.
    - \* The time can be changed in 1-hour units. It cannot be set to 2 a.m. or 3 a.m.
  - OFF (Off): Automatic reception is not performed.
  - AUT (Auto): Automatic reception is performed according to the initial settings (at 2 a.m., 3 a.m. and 4 a.m.).

### <Setting procedure>

1. Pull the crown out to position 1 and turn to align the mode hand with RX-S (receive set mode).
2. Pull the crown out to position 2 to enter the daylight saving time (SMT) reception setting status.
  - AU or mA flashes and the watch enters the correction status.
  - Each time the upper right button (B) is pressed, the display switches between the daylight saving time reception setting and the automatic reception setting.
3. Press the lower right button (A) to select AU or mA.

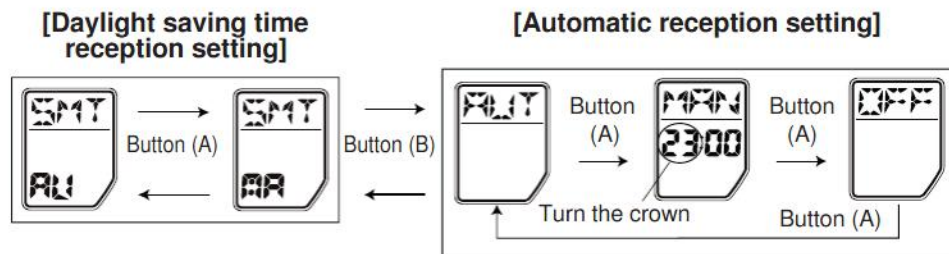

4. Press the upper right button (B) to enter the automatic reception setting status.
  - The set automatic reception status flashes.
  - AUT, MAN and OFF flash and the watch enters the correction status.
5. Press the lower right button (A) to set the automatic reception operating condition to MAN.
  - The hour of the reception time flashes.
  - Each time the lower right button (A) is pressed, the correction location changes in the following sequence: AUT → MAN → OFF.
6. To change the reception time, turn the crown to change the time in 1-hour units.
  - Turn the crown to the right to move the time forward and to the left to move the time back.
  - Only the 4 a.m. automatic reception can be changed. (2 a.m. and 3 a.m. are not displayed.)
  - Only the hour can be changed, and when using the 12-hour clock, "A" indicates a.m. and "P" indicates p.m.
7. Press the crown back into its normal position.
  - \* Nighttime is usually a good time for reception because radio wave noise is relatively low.

## 21. LED Lights

- Press the upper right button (B) while the crown is in the normal position to turn on the LED lights of digital displays 1 and 2 for three seconds. However, note that the lights do not come on in the following cases.
  - \* During timer mode or chronograph mode
  - \* During radio wave reception
  - \* During 2-second interval movement (insufficient charge warning status)

## 22. Resetting Your Watch

- If the watch displays or operates abnormally due to a strong impact or the effects of static electricity, reset the watch and then correct the reference position.

**[Caution]** After resetting, all the mode settings return to their initial settings. Perform the settings again as required.

### <Initial settings after resetting>

- Home city/world city: UTC • Time: 0:00:00
- Date: January 1, 2008 (Tuesday) • Timer: 99 minutes 00 seconds
- Chronograph: 0 hours 00 minutes 00 seconds (reset status)
- World time: City displays - all SET, daylight saving time - all OF (off)
- Alarm 1/2: City - UTC, time - 12:00, set - OF (off)
- Receive set: Daylight saving time - AU, automatic reception - AUT

### <Resetting procedure>

1. Pull the crown out to position 1 and turn to align the mode hand with CHR (chronograph mode).
2. Pull out the crown to position 2.
  - The hands will rotate rapidly.
3. After the hands stop, press buttons (A) and (B) at the same time.
  - When you remove your finger from the buttons, all parts of the digital displays and the lights will come on.
  - The confirmation tone sounds, the hands move clockwise and counterclockwise and the watch switches to the reference position checking status.
4. If the reference position is incorrect, correct it. (Refer to “Checking the Reference Position” (p. 14) and “Adjusting the Reference Position” (p. 74).)

### All parts displayed

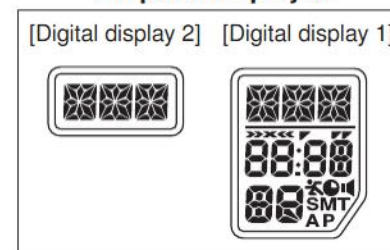

## 23. Adjusting the Reference Position

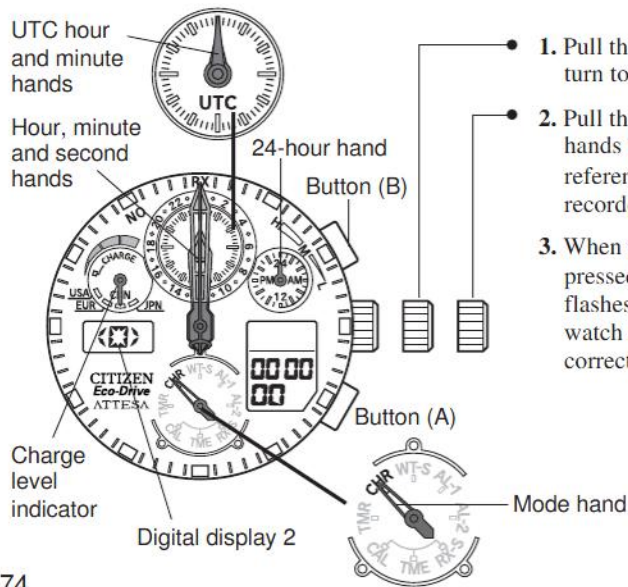

1. Pull the crown out to position 1 and turn to align the mode hand with CHR.
2. Pull the crown out to position 2. The hands will move rapidly and stop at the reference position (12:00 position) recorded in the watch memory.
3. When the upper right button (B) is pressed for more than 2 seconds, CHA flashes in digital display 2 and the watch enters the reference position correction status.

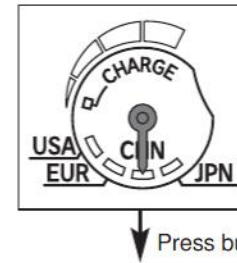

4. ① Adjusting the charge level indicator
  - (1) Display CHA in digital display 2.
  - (2) Turn the crown to align the charge level indicator of the watch face with the center of CHN.
 \* Turn the crown continuously to move quickly. To stop, turn the crown to the left or right.
 \* If no correction is required, proceed to the next step.

Press button (B).

5. Each time the upper right button (B) is pressed in the reference position correction status, digital display 2 changes in the sequence CHA → UTC → HR → MIN, and the corresponding hand moves to show the location to be corrected.

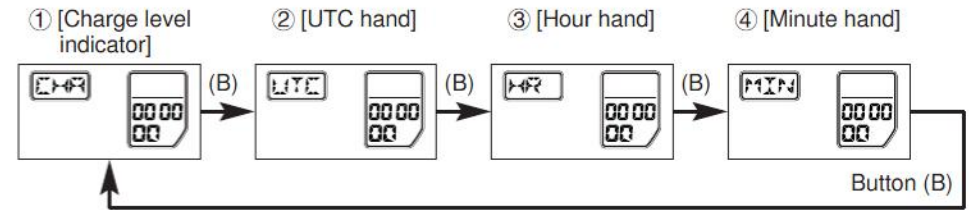

6. ② Adjusting the UTC hands (hour hand and minute hand)

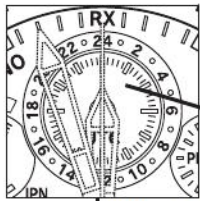

- (1) Press the upper right button (B) to display UTC in the digital display.
- (2) Turn the crown to align the UTC hour hand and minute hand with 12:00.



UTC hour and minute hands

- If the hands overlap and are difficult to see, press the lower right button (A) to move the minute hand by -3 minutes to make the UTC hands easier to see. Press the lower right button (A) again to return the minute hand to its original position.

Press the upper right button (B).

7. ③ Adjusting the hour hand

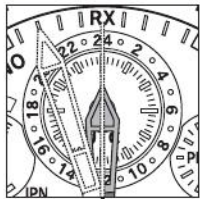

- (1) Press the upper right button (B) to display HR in digital display 2.
- (2) Turn the crown to align the hour hand with 12:00.
  - Press the lower right button (A) to move the minute hand by -3 minutes to make the hour hand easier to see. Press the lower right button (A) again to return the minute hand to its original position.

\* The 24-hour hand moves in tandem with the hour hand, so make sure that the a.m. and p.m. setting is correct.

Press the upper right button (B).

8. ④ Adjusting the minute hand

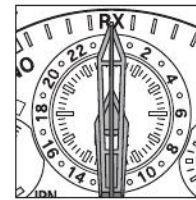

- (1) Press the upper right button (B) to display MIN in digital display 2.
- (2) Turn the crown to align the minute hand with 12:00.

9. When the upper right button (B) is pressed for more than 2 seconds after adjusting all the hands to their correct reference positions, (0) is displayed in digital display 2 to show that the reference position adjustment is completed.
10. Put the crown in position 1, set to the mode that you usually use, and then return the crown to the normal position.

## Using the Slide Rule Bezel

The following measurements and calculations are possible depending on the model.

Model 1: Measurement of elapsed time, remaining time

Model 2: Navigation calculations, general calculations

\* Depending on the model, some additional features may not be available.

### Model 1

#### <Operation method>

Turning the crown at the 8:00 position causes the slide rule bezel surrounding the watch face to rotate.

Crown for turning the outer scale



#### <Measuring the elapsed time>

Align the  $\nabla$  mark ( $\bigcirc$  mark for this model) on the slide rule bezel with the minute hand. After a certain time has elapsed, you can estimate how much time has elapsed by using the slide rule bezel as a guideline.



Elapsed time: This indicates 10 minutes have elapsed since 9:10.

### <Measuring remaining time>

You can tell how much time remains by aligning the  $\nabla$  mark (or  $\bigcirc$  mark) on the slide rule bezel with the target time.



Remaining time: This indicates that 20 minutes remain until 9:25.

### Model 2

#### A. Navigation Calculator

##### 1. Calculation of time required

**Problem:** How long does it take an airplane flying at 180 knots to fly a distance of 450 nautical miles?

**Solution:** Set the 18 mark on the outside scale to the SPEED INDEX ( $\blacktriangle$ ). At this time, the point on the inside scale that is aligned with 45 on the outside scale indicates (2:30), and the answer is 2 hours and 30 minutes.

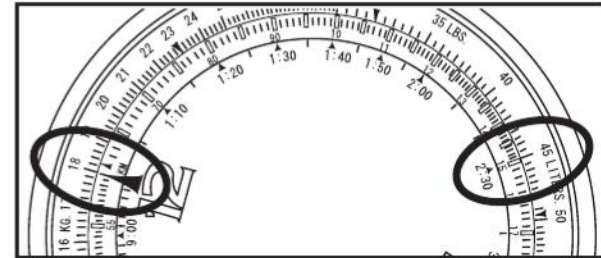

## 2. Speed (Ground Speed) Calculation

**Problem:** What is the speed (ground speed) of an airplane when it takes 1 hour and 20 minutes to fly a distance of 240 nautical miles?

**Solution:** Align the 24 on the outside scale with 1:20 (80) on the inside scale. At this time, 18 is aligned with the SPEED INDEX (▲) on the inside scale, and the answer is 180 Kt.

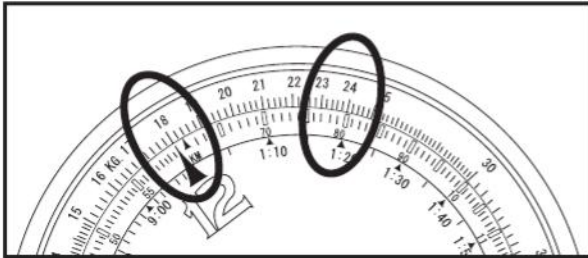

## 3. Flying distance calculation

**Problem:** What is the flying distance traveled in 40 minutes at a speed of 210 knots?

**Solution:** Align the 21 on the outside scale with the SPEED INDEX (▲) of the inside scale. The 40 of the inside scale is now pointing to 14, and the answer is 140 nautical miles.

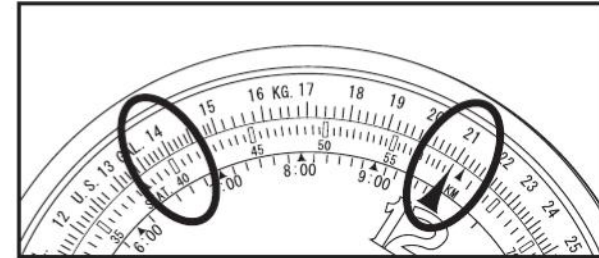

#### 4. Fuel consumption rate calculation

**Problem:** If 120 gallons of fuel are consumed in 30 minutes' flying time, what is the fuel consumption rate?

**Solution:** Align the 12 of the outside scale with 30 of the inside scale. The SPEED INDEX (▲) now points to 24, and the answer is 240 gallons per hour.

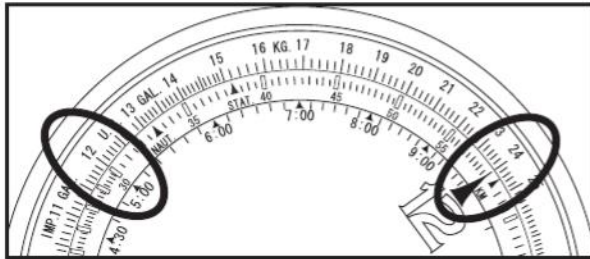

#### 5. Fuel consumption calculation

**Problem:** How much fuel is consumed in 6 hours at a fuel consumption rate of 250 gallons per hour?

**Solution:** Align the 25 of the outside scale with the inside scale's SPEED INDEX (▲) of the inside scale. The 6:00 is aligned with 15, and the answer is 1500 gallons.

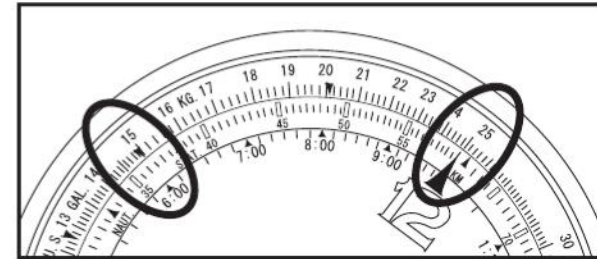

### 6. Maximum flying hours

**Problem:** With a fuel consumption rate of 220 gallons per hour and a fuel supply of 550 gallons, what is the maximum number of flying hours?

**Solution:** Align the 22 of the outside scale with the inside scale's SPEED INDEX (▲) of the inside scale. The 55 of the outside scale is now aligned with 2:30, and the answer is 2 hours and 30 minutes.

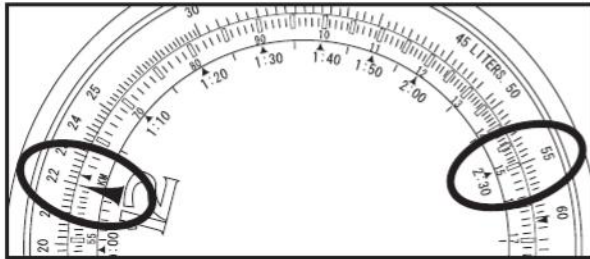

### 7. Conversion

**Problem:** How do you convert 30 miles into nautical miles and kilometers?

**Answer:** Align the 30 on the outside scale with the STAT (▲) mark on the inside scale. At this time, 26 nautical miles is aligned at the NAUT (▲) mark on the inside scale, while the answer of 48.2 kilometers is aligned at the kilometers on the inside scale.

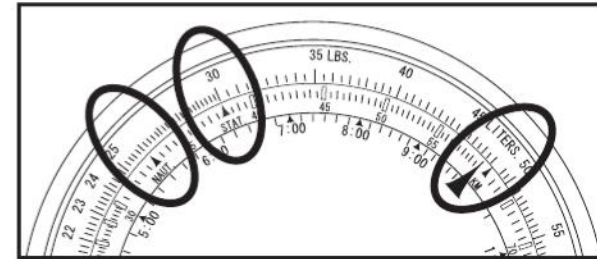

## B. General calculation functions

### 1. Multiplication

**Problem:**  $20 \times 15$

**Solution:** Align 20 on the outside scale with 10 on the inside scale, and read the outside scale at the 30 mark which is aligned with 15 of the inside scale.  
Figure the number of decimal places, and the answer is 300.

**Remember:** decimal places cannot be read on this scale.

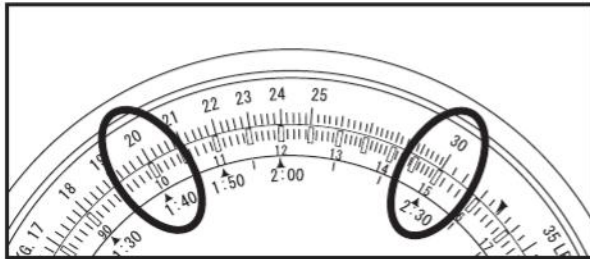

### 2. Division

**Problem:**  $250/20$

**Solution:** Align 25 on the outside scale with 20 on the inside scale. On the outside scale read the 12.5 mark that is aligned with 10 on the inside scale. Figure the number of decimal places, and the answer is 12.5.

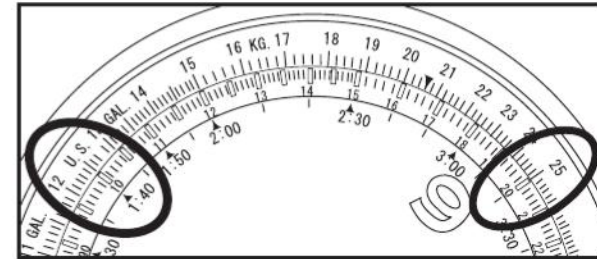

### 3. Reading Ratios

**Problem:**  $30/20 = 60/x$

**Solution:** Align 30 on the outside scale with 20 on the inside scale. At this time, the answer of 40 can be read from the inside scale corresponding to 60 on the outside scale. In addition, the ratio of the value on the outside scale to the value on the inside scale is 30:20 at all positions on the scales.

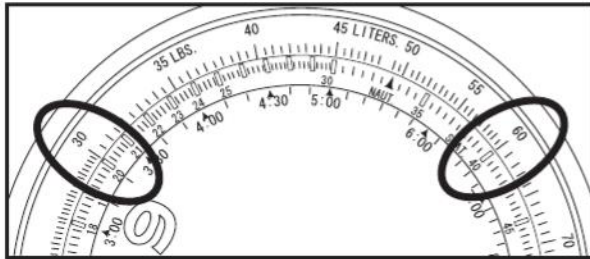

### 4. Determining Square Root

**Problem:** What is the square root of 225?

**Solution:** Rotate the scales so that the value on the inside scale corresponding to 22.5 on the outside scale is equal to the value on the outside scale corresponding to 10 on the inside scale, and read off the answer of 15 at that location.

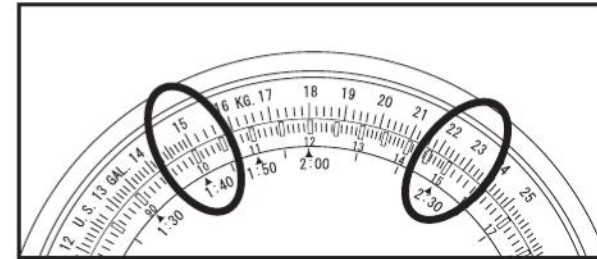

## ■ 24. Solar Power Function

This watch uses a secondary battery to store electrical energy. When the watch is fully charged, it will run for about 6 months.

### <Ensuring best operation of the watch>

Always store the watch in a bright location for best results.

- ◆ An effective way of charging the watch is to keep it in a bright location when you are not wearing it, such as near a window where it can receive direct sunlight.

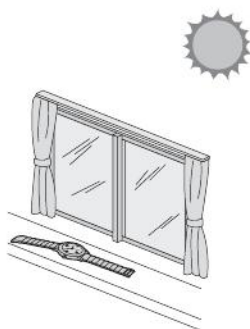

- ◆ Wearing clothes with long sleeves makes it difficult for the watch to get the necessary light, resulting in insufficient charging. We recommend that you charge the watch for a long time in direct sunlight once a month.

**[Caution]** Do not charge on surfaces that can easily become hot, such as a car dashboard.

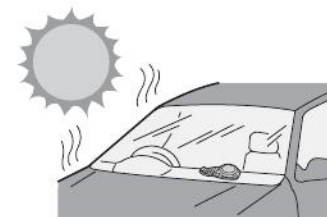

## 25. Characteristics of the Solar Powered Watch

⊙ When the watch is insufficiently charged, the indication will be changed as follows:

- \* 1. When the watch stopped due to insufficient charging
  - It takes at least 30 minutes to recharge sufficiently to perform recovery automatic reception, even if the watch is being exposed to light.
  - After recovery, refer to “Guide to Charging Time” (p. 100) and sufficiently charge the watch.
- \* 2. If the watch failed to perform recovery automatic reception
  - The time is incorrect even if the second hand moves at 1-second intervals, so after fully charging the watch, set the time manually or perform on demand reception.

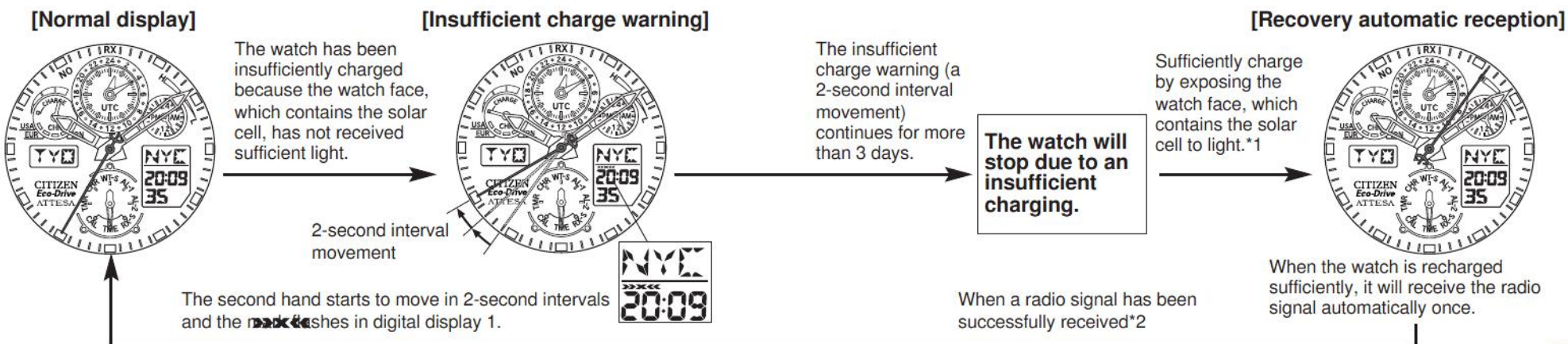

## A. Power Saving Function

If the watch face is not exposed to light for a long time, the power saving function is activated to minimize the battery consumption.

- Power saving 1: When power is not generated for more than 30 consecutive minutes, the digital displays go off to save power.
- Power saving 2: When the power saving 1 condition continues for 7 days or longer, to save power, the hour hand, minute hand, second hand and 24-hour hand move to the reference position, and the charge level indicator and UTC hands (hour and minute) stop in their current positions.
  - The correct time continues to be kept inside the watch.
  - The alarm tone will not sound.

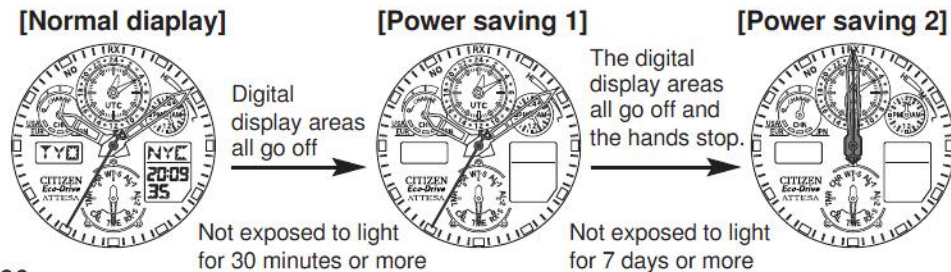

## <Canceling the power saving function>

The power saving function will be automatically canceled when the watch face is exposed to light.

- When power saving 1 is canceled, the digital display is restored.
- After the power saving 2 has been canceled, the hands will rapidly move to the current time and return to 1-second interval movement.
- If the watch is insufficiently charged, the second hand will begin the 2-second interval movement. Return the second hand to 1-second interval movement by sufficiently charging the watch.
- Power saving is cancelled if the insufficient charge warning function activates during power saving mode.

## B. Insufficient Charge Warning Function

When the charge level indicator reaches level 0, the second hand's movement changes from 1-second intervals to 2-second intervals and the **▶▶▶▶** flashes in digital display 1 to show that the watch is insufficiently charged.

The watch will stop due to insufficient charging about 3 days after starting the 2-second interval movement if kept in a place with no light.

**[Caution]** During 2-second interval movement, the digital displays and watch operations change as follows.

- The time cannot be adjusted manually, or by using automatic reception or on demand reception.
- Push button operations are not possible.
- All modes change to time mode.
- The alarm tone and confirmation tone will not sound. (When the timer, chronograph or alarm is used)
- The LED lights will not come on.
- The chronograph and timer are forcibly reset and cannot be operated.

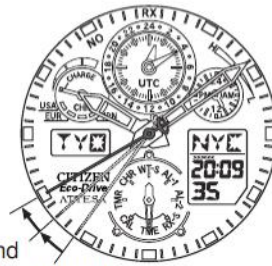

2-second interval movement

- ◆ If the charging insufficiency occurs during radio signal reception, the operation will stop automatically, the watch will return to the time before the operation, and 2-second interval movement will begin.  
Regularly charge your radio controlled watch so it does not become insufficiently charged.

## C. Overcharging Prevention Function

When the secondary battery becomes fully charged by exposing the watch face to light, the overcharging prevention function is automatically activated to prevent the battery from being charged further.

No matter how much the watch is charged, it will not affect the secondary battery, timekeeping, functions or performance of the watch.

## D. Guide to Charging Time

The charging time varies according to the model (including the color of the watch face). The following data should only be used as a guideline.

\*The charging time is based on continuous exposure.

Illuminance (lx)	Environment	Charging time (approximate)		
		For a 1-day movement charging time	Time from stopping to resuming the 1-second interval movement	Time for full charging
500	Indoor lighting	4 hours	-----	-----
1,000	60 to 70 cm beneath a 30 W fluorescent light	2 hours	-----	-----
3,000	20 cm beneath a 30 W florescent light	40 minutes	5 hours	-----
10,000	Cloudy sky	12 minutes	2 hours	60 hours
100,000	Direct summer sunlight	4 minutes	40 minutes	30 hours

\* If the second hand is moving in 2-second intervals, refer to “Time for full charging” and fully charge.

For a 1-day movement charging time ... The charging time to run the watch for one day with normal movement.

Time for full charging ... The time for full charging after the watch has stopped due to an insufficient charging.

**[Caution]** A fully charged battery will run the watch for about 6 months without further charging. During power saving mode, the correct time continues to be kept inside the watch for approximately three and a half years.

Charge the watch every day, as it will take a long time to recharge it, as is indicated in the table, when it stops due to an insufficient charging. Furthermore, it is recommended to charge your watch by exposing to direct sunlight for a long time once a month.

## E. Handling Your Solar Powered Watch

### **WARNING** Handling the secondary battery

- ◆ Do not remove the secondary battery from the watch yourself, unless unavoidable. If you must remove the battery, store it out of reach of children to avoid accidental ingestion. If the secondary battery is ingested, consult a doctor immediately.
- ◆ Do not throw away with regular trash. Doing so could cause a fire or environmental damage. Follow the collection procedures as specified by your local authority.

### **WARNING** Do not use anything other than the specified secondary battery

- ◆ The watch will not operate if incorrect battery types are inserted. Never use a regular silver battery. The battery could overcharge during the charging process and burst, causing damage to the watch or injuries to the wearer.

### **CAUTION** Charging precautions

- ◆ Do not charge the watch in a high-temperature environment (about 60°C / 140°F or more). Overheating while charging can cause the watch exterior to become discolored, the watch to deform or the movement to be damaged.  
**Example:**
  - Charging close to incandescent lighting, halogen lamps, or other lighting sources that easily become hot.
  - Charging on surfaces that can easily become hot, such as a car dashboard.
- ◆ When charging with incandescent lighting, halogen lamps, or other lighting sources that easily become hot, place the watch at least 50 cm (20 in.) away from the source to avoid overheating.

## Troubleshooting

### <Radio Signal Reception Function>

Problem	Check	Remedy
Radio signals cannot be received.	<ul style="list-style-type: none"> <li>Is the home city (digital display 2) set to the same reception area as your current location?</li> </ul>	<ul style="list-style-type: none"> <li>Check the map and change the setting.                             <ul style="list-style-type: none"> <li>Check the map. (p. 28~33)</li> <li>Change the setting. (p. 44~45)</li> </ul> </li> </ul>
	<ul style="list-style-type: none"> <li>Are you moving the watch while receiving a signal and the second hand is showing RX, H, M or L?</li> </ul>	<ul style="list-style-type: none"> <li>Do not move the watch until the signal has been properly received (until normal hand movement is restored). (Reception can take from about 2 minutes to a maximum of 15 minutes.)</li> </ul>

Problem	Check	Remedy
Radio signals cannot be received.	<ul style="list-style-type: none"> <li>Are there objects nearby that could block radio signals or generate noise?</li> <li>Are you attempting to receive the radio signal in a location far from a window?</li> </ul>	<ul style="list-style-type: none"> <li>Avoid objects that block radio signals or generate noise. Try to receive radio signals by pointing the 9:00 position of the watch in the direction of the radio signal transmitter. Find a location such as window that is conducive to radio signal reception and change the watch location, direction and angle. (p. 23)</li> </ul>
	<ul style="list-style-type: none"> <li>Is the second hand moving at 2-second intervals? (When the second hand moves in 2-second intervals, the &gt;&gt;&gt;&lt;&lt;&lt; insufficient charge warning mark flashes in the digital display 1 and the charge level indicator points at level 0.)</li> </ul>	<ul style="list-style-type: none"> <li>Radio waves cannot be received when the charge is insufficient. Charge the watch sufficiently by placing it in direct sunlight as indicated in "Guide to Charging Time". (p. 100)</li> </ul>

Problem	Check	Remedy
<b>Radio signals cannot be received.</b>	<ul style="list-style-type: none"> <li>• Is the mode hand pointing to a mode other than TME, CAL or RX-S?</li> <li>• Is chronograph or timer measurement in progress?</li> </ul>	<ul style="list-style-type: none"> <li>• Pull the crown out to position 1 and set the mode to TME, CAL or RX-S.</li> <li>• Stop the measurement, reset, and try to receive the radio wave again.</li> </ul>
<b>The time is not correct.</b>	<ul style="list-style-type: none"> <li>• Is the reference position set correctly? Check the reference position. (p. 14)</li> </ul>	<ul style="list-style-type: none"> <li>• If the reference position is not correctly set, adjust it as indicated in “Adjusting the Reference Position”. (p. 74)</li> </ul>

Problem	Check	Remedy
<b>The time is not correct.</b>	<ul style="list-style-type: none"> <li>• Check the reception status.</li> <li>• Check whether the daylight saving time is ON or OFF (off). (p. 46)</li> </ul>	<ul style="list-style-type: none"> <li>• If the reception status is NO, change your location and try to receive the radio wave again. “On Demand Reception” (p. 20)</li> <li>• In TME or WT-S mode, select daylight saving time ON or OFF (off).</li> </ul>
<b>The watch successfully received the radio wave, but it deviates slightly from the correct time.</b>		<ul style="list-style-type: none"> <li>• A slight deviance (less than 1 second) may be caused by the internal processing of the watch.</li> </ul>
<b>The second hand moved suddenly to the reception standby (RX) position.</b>	<ul style="list-style-type: none"> <li>• Have you set the 4 a.m. automatic reception to a different time?</li> </ul>	<ul style="list-style-type: none"> <li>• Check again the automatic reception setting of the RX-S (receive set) mode. (p. 68)</li> </ul>

<Eco-Drive>

Problem	Check	Remedy
<b>The watch has stopped.</b>	<ul style="list-style-type: none"> <li>Is the charge level indicator pointing at level 0?</li> </ul>	<ul style="list-style-type: none"> <li>Charge the watch sufficiently until the charge level indicator reaches level 3, as indicated in "Guide to Charging Time". <b>(p. 41)</b></li> </ul>
	<ul style="list-style-type: none"> <li>Is "ERR" displayed in digital display 1?</li> </ul>	<ul style="list-style-type: none"> <li>Reset the watch <b>(p. 72)</b> and then correct the reference position. <b>(p. 74)</b> If "ERR" is displayed again, contact the store where you purchased the watch or a Citizen Service Center.</li> </ul>
<b>The watch does not work even after charging.</b>	<ul style="list-style-type: none"> <li>Did you charge the watch sufficiently in sunlight?</li> </ul>	<ul style="list-style-type: none"> <li>Charge the watch sufficiently, as indicated in "Guide to Charging Time". <b>(p. 100)</b> If the watch does not work even after charging, contact a Citizen Service Center.</li> </ul>

Problem	Check	Remedy
<b>The second hand is moving in 2-second intervals.</b>	<ul style="list-style-type: none"> <li>Is the charge level indicator pointing at level 0?</li> </ul>	<ul style="list-style-type: none"> <li>Charge the watch sufficiently until the charge level indicator reaches the fully charged level. <b>(p. 41)</b></li> </ul>
<b>The hands moved forward quickly at the moment that the watch was removed from a desk or drawer.</b>		<ul style="list-style-type: none"> <li>This is because the power saving mode was canceled when the watch was exposed to light, and the hands moved forward quickly to the current time. It is ready to use. <b>(p. 96)</b></li> </ul>
<b>The hands or digital displays are abnormal.</b>		<ul style="list-style-type: none"> <li>Reset the watch. <b>(p. 72)</b> (The internal watch system became unstable because of strong static electricity or other external influence.)</li> </ul>

## Precautions

### WARNING: Water-resistance performance





There are several types of water-resistant watches, as shown in the following table.

The unit "bar" is roughly equal to 1 atmosphere.

\* WATER RESIST(ANT) xx bar may also be indicated as W.R. xx bar.

Indication		Specifications
Dial	Case (case back)	
WATER RESIST or no indication	WATER RESIST(ANT)	Water-resistant to 3 atmospheres
WR 50 or WATER RESIST 50	WATER RESIST(ANT) 5 bar or WATER RESIST(ANT)	Water-resistant to 5 atmospheres
WR 100/200 or WATER RESIST 100/200	WATER RESIST(ANT) 10bar/20 bar or WATER RESIST(ANT)	Water-resistant to 10/20 atmospheres

For correct use within the design limits of the watch, confirm the level of water-resistance of your watch, as indicated on the dial and case, and consult the table.

					Examples of use				
					Minor exposure to water (washing face, rain, etc.)	Moderate exposure to water (washing, kitchen work, swimming, etc.)	Marine sports (skin diving)	Scuba diving (with air tank)	Operation of the crown or button with moisture visible
<b>OK</b>	<b>NO</b>	<b>NO</b>	<b>NO</b>	<b>NO</b>					
<b>OK</b>	<b>OK</b>	<b>NO</b>	<b>NO</b>	<b>NO</b>					
<b>OK</b>	<b>OK</b>	<b>OK</b>	<b>NO</b>	<b>NO</b>					

**WARNING: Water-resistance performance**

- Water-resistance for daily use (to 3 atmospheres): This type of watch is water-resistant to minor exposure to water. For example, you may wear the watch while washing your face; however, it is not designed for use underwater.
- Upgraded water-resistance for daily use (to 5 atmospheres): This type of watch is water-resistant to moderate exposure to water. You may wear the watch while swimming; however, it is not designed for use while skin diving.
- Upgraded water-resistance for daily use (to 10/20 atmospheres): This type of watch may be used for skin diving; however, it is not designed for scuba or saturated diving using helium gas.

**CAUTION**

- Be sure to use the watch with the crown pressed in (normal position). If your watch has a screw-lock type crown, be sure to tighten the crown completely.
- Do NOT operate the crown or button with wet fingers or when the watch is wet. Water may enter the watch and compromise water-resistance.
- If the watch is used in seawater, rinse with fresh water afterward and wipe with a dry cloth.
- If moisture has entered the watch, or if the inside of the crystal is fogged up and does not become clear within a day, immediately take the watch to your dealer or Citizen Service Center for repair. Leaving the watch in such a state will allow corrosion to form inside.

- If seawater enters the watch, place the watch in a box or plastic bag and immediately take it in for repair. Otherwise, pressure inside the watch will increase, and parts (crystal, crown, buttons, etc.) may come off.

**CAUTION: Keep your watch clean.**

- Leaving dust and dirt deposited between the case and crown may result in difficulty in pulling the crown out. Rotate the crown while in its normal position, from time to time, to loosen dust and dirt and then brush it off.
- Dust and dirt tend to be deposited in gaps in the back of the case or band. Deposited dust and dirt may cause corrosion and soil your clothing. Clean the watch occasionally.

**Cleaning the Watch**

- Use a soft cloth to wipe off dirt, perspiration and water from the case and crystal .
- Use a soft, dry cloth to wipe off perspiration and dirt from the leather band.
- To clean a metal, plastic, or rubber watchband, wash away dirt with mild soap and water. Use a soft brush to remove dust and dirt jammed in the gaps in the metal band. If your watch is not water-resistant, take it to your dealer.

**NOTE:** Avoid using solvents (thinner, benzine, etc.), as they may damage the finish.

**CAUTION: Operating environment**

- Use the watch within the operating-temperature range specified in the instruction manual.  
Using the watch where temperatures are outside the specified range, may result in deterioration of functions or even stoppage of the watch.
- Do NOT use the watch in places where it is exposed to high temperature, such as in a sauna.  
Doing so may result in a skin burn.
- Do NOT leave the watch in a place where it is exposed to high temperature, such as the glove compartment or dash-board of a car.  
Doing so may result in deterioration of the watch, such as deformation of plastic parts.
- Do NOT place the watch close to a magnet.  
Timekeeping will become inaccurate if you place the watch close to magnetic health equipment such as a magnetic necklace or a magnetic latch of a refrigerator door or handbag clasp or the earphone of a mobile phone. If this has occurred, move the watch away from the magnet and reset the time.
- Do NOT place the watch close to household appliances that generate static electricity.  
Timekeeping may become inaccurate if the watch is exposed to strong static electricity, such as is emitted from a TV screen.
- Do NOT subject the watch to a strong shock such as dropping it onto a hard floor.

- Avoid using the watch in an environment where it may be exposed to chemicals or corrosive gases.

If solvents, such as thinner and benzine, or substances containing such solvents come in contact with the watch, discoloration, melting, cracking, etc. may result. If the watch comes in contact with mercury used in thermometers, the case, band or other parts may become discolored.

**Periodical inspections**

Your watch needs inspection once in every two or three years for safety and long use.

To keep your watch water-resistant, the packing needs to be replaced regularly.

Other parts need to be inspected and replaced if necessary.

Ask for Citizen genuine parts upon replacement.

## ■ 26. Specifications

1. Cal. No.: U68\*
2. Type: Combination solar powered watch
3. Time accuracy: Without reception (when watch is not receiving a radio signal)  
Average monthly deviation: ±15 seconds  
when used in room temperature (+5°C to +35°C / 41°F to 95°F)
4. Acceptable temperature range: 0°C to + 50°C / 32°F to 122°F

### 5. Display functions

#### [Analog areas]

- Home city time: Hours, minutes, seconds, 24-hour
- UTC time: Hours, minutes
- Charge level display (fan-shaped display, 4 grades)
- Radio wave reception display: Japan: JJY, USA: WWVB, Europe (Germany: DCF77), China: BPC

#### [Digital areas]

- Home city name/world city name
- World city time: Hours, minutes and seconds (switch between 12-hour and 24-hour clock)

- Daylight saving time on/off
  - Calendar: Month, date, day of week (perpetual calendar until December 31, 2099)
- ### 6. Additional functions
- Radio signal reception function (automatic reception, on demand reception, recovery automatic reception)
  - Radio wave transmitter automatic selection function (only when radio wave from Japan)
  - Reception on/off selection function
  - Reception standby indication function (RX)
  - Reception level indication function (H, M, L)
  - Reception status confirmation function (H, M, L or NO)
  - Automatic reception time setting function
  - Daylight saving time on/off selection function
  - World time alarm 1 and 2: Hours, minutes, AM/PM, city name, on/off, alarm check function
  - Chronograph (24-hour measurement, 1/100 second units, split time measurement)
  - Timer (setting range: from 1 minute up to 99 minutes, in 1-minute units)  
Flyback function, auto return function
  - World time display function

- Time difference set by user
- Zone set function (city name display SET/OFF)
- Home time (analog) and world time (digital) switching function
- LED lights
- Power saving function 1
- Power saving function 2
- Reference position checking/adjustment function
- Solar power function
- Insufficient charge warning function (2-second interval movement)
- Overcharging prevention function
- JIS Type-1 antimagnetic watch
- Impact detection function
- Hand correction function

**7. Operation time:**

- Time from a full charge until the watch stops without charging
  - : About 3.5 years (when in the power saving mode)
  - : About 6 months (when not in the power saving mode)
  - (The operation time may vary depending on the conditions of use, such as how many times the radio wave is received.)
- Time from insufficient charge warning to watch stopping:
  - About 3 days

**8. Battery: Secondary battery 1**

\* Specifications may change without notice.