

**MIYOTA**

# STOPWATCH!

---

---

---

|  |  |
|--|--|
|  |  |
|  |  |
|  |  |
|  |  |
|  |  |
|  |  |
|  |  |
|  |  |

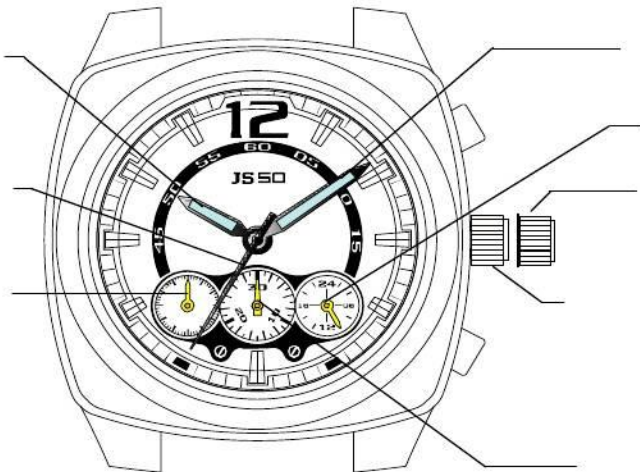

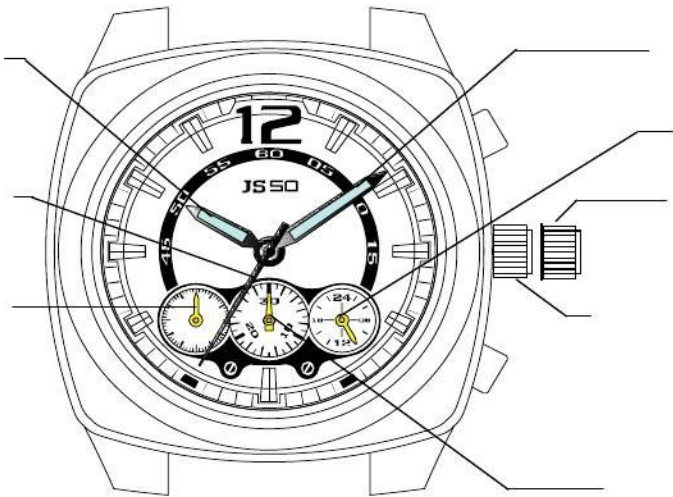

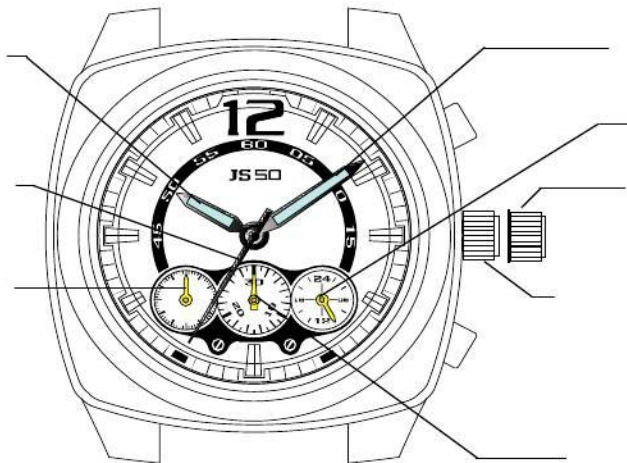
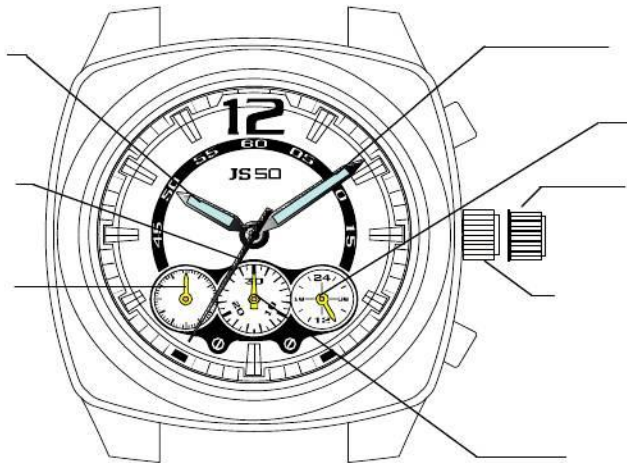

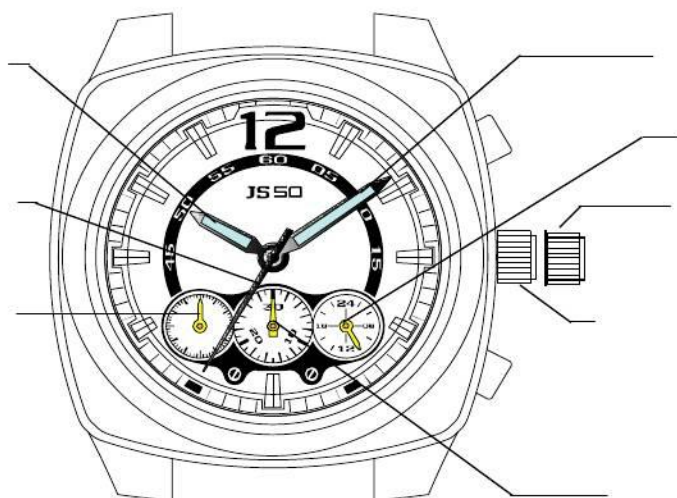



confidential papers 2012/12/18 (10:31:01)

This drawing is provisional and subject to our reconfirmation and/or revision without notice.

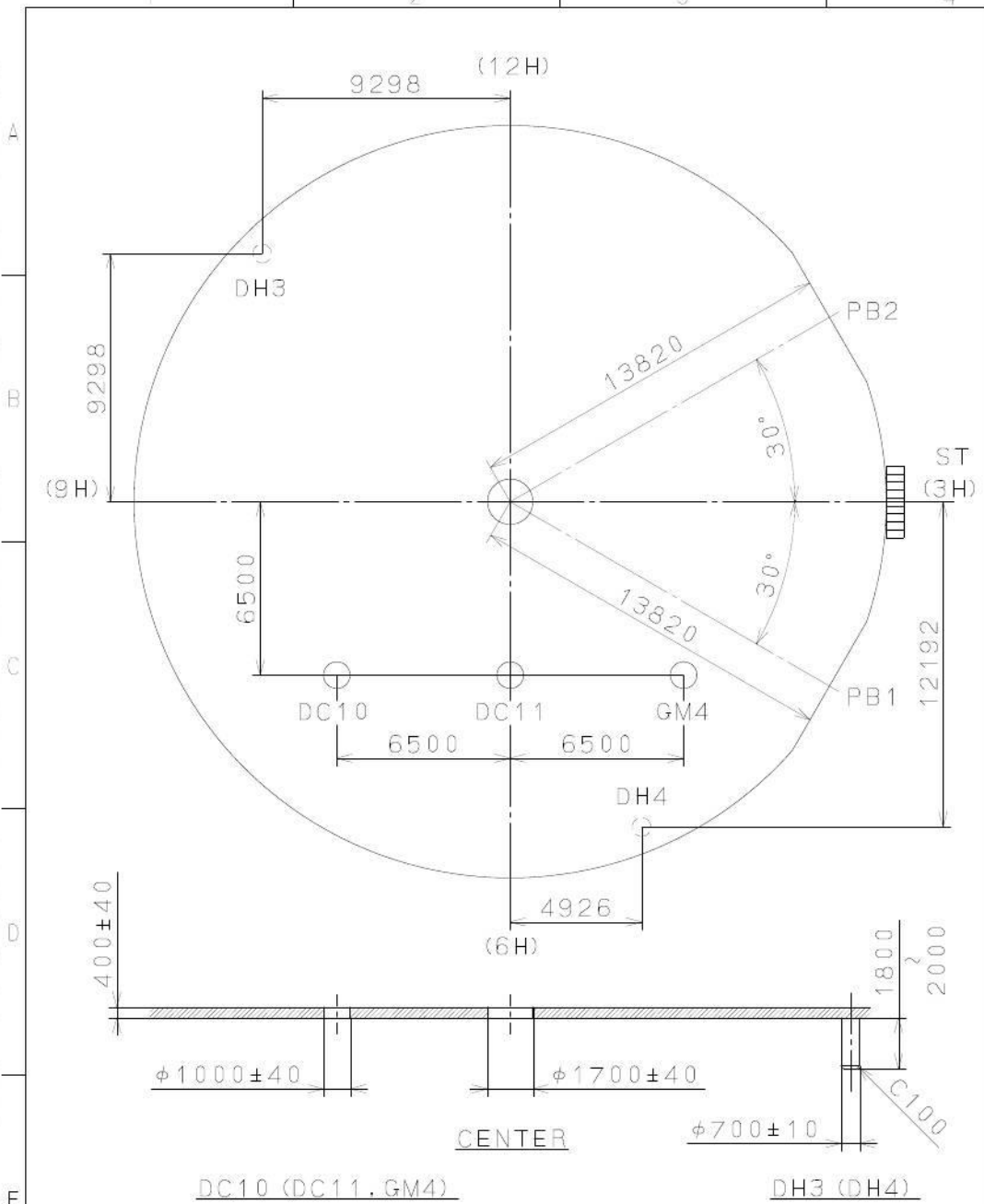

|                |  |  |                    |  |                       |
|----------------|--|--|--------------------|--|-----------------------|
| △              |  |  | Quantity           |  | Cal. NO.:             |
| △              |  |  | Unit               | 1/1000mm   | JS50-00C              |
| △              |  |  | Scale              | 5:1  | Parts No.:            |
| △              |  |  | Date               |  |                       |
| △              |  |  | Drawn              |  |                       |
| Material       |  |  | Checked            | N. Suzuki  | Name:                 |
| Heat Treatment |  |  | Approved           |  | Indications for Dial  |
| Hardness       |  |  |                    |  | Drawing No.: JS500001 |
| Plating        |  |  |                    |  |                       |
|                |  |  | General Tolerances | <b>MIYOTA</b><br>CITIZEN WATCH CO., LTD., TOKYO, JAPAN |                       |
|                |  |  | Dimensions         |  |                       |
|                |  |  | Angles             |  |                       |

2006/12/25 (07:50:10)

This drawing is provisional and subject to our reconfirmation and/or revision without notice.

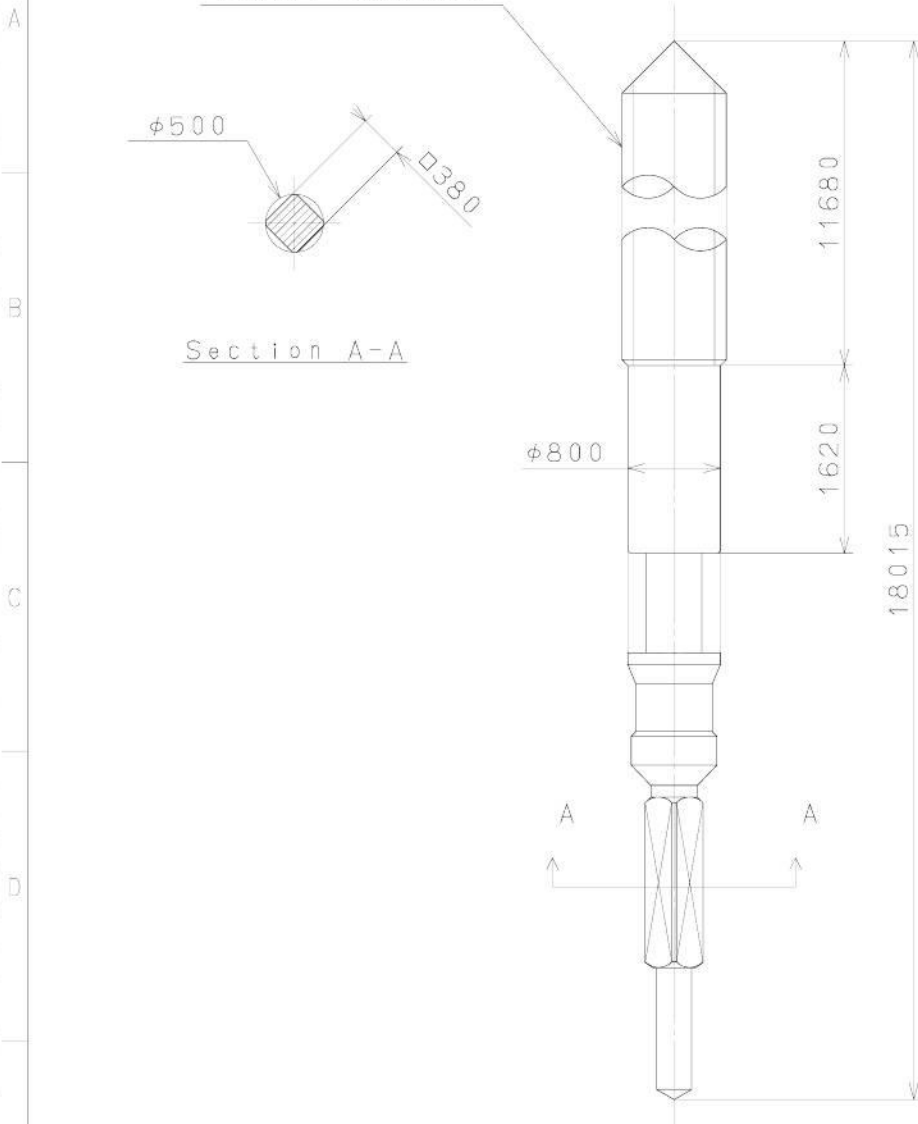

|                |      |             |                    |                      |                                       |
|----------------|------|-------------|--------------------|----------------------|---------------------------------------|
| △              |      |             | Quantity           |                      | Cal. NO.:                             |
| △              |      |             | Unit               | 1/1000 <sub>mm</sub> |                                       |
| △              |      |             | Scale              | 20/1                 | Parts No.:                            |
| △              |      |             | Date               |                      | 065-505                               |
| △              |      |             | Drawn              |                      |                                       |
| Mark           | Date | Description | Appr.              | Checked              | Name:                                 |
|                |      | Alterations |                    | Approved             | T. Hirata                             |
| Material       |      |             |                    |                      | SETTING STEM                          |
| Heat Treatment |      |             |                    |                      | Drawing No.: 5050S000                 |
| Hardness       |      |             | General Tolerances |                      | <b>MIYOTA</b>                         |
| Plating        |      |             | Dimensions         |                      |                                       |
|                |      |             | Angles             |                      |                                       |
|                |      |             |                    |                      | CITIZEN WATCH CO., LTD., TOKYO, JAPAN |



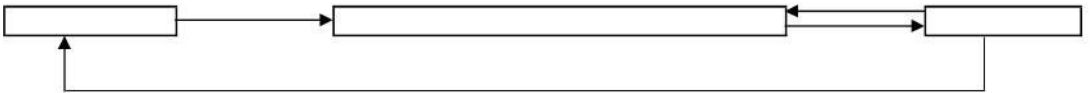
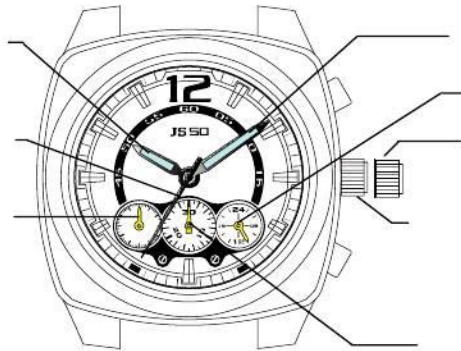

# MIYOTA

---

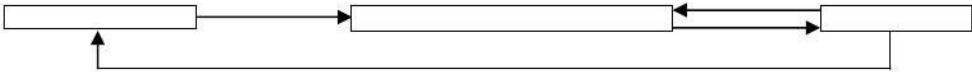
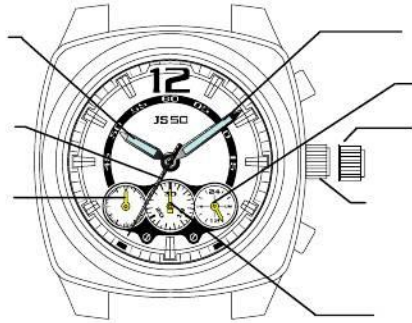

# MIYOTA

---

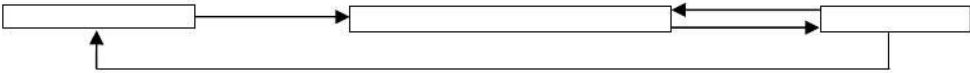
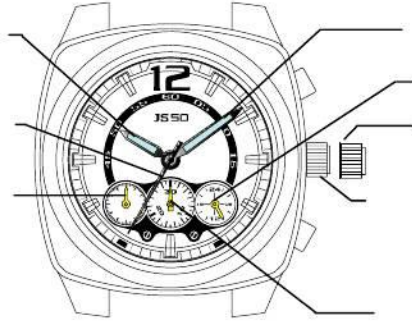

# MIYOTA

---

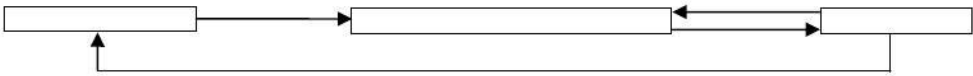
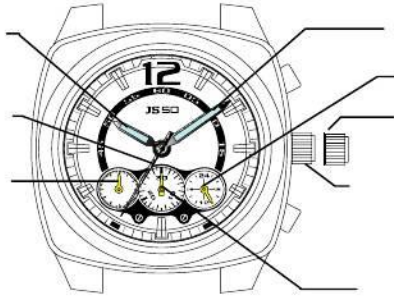

# MIYOTA

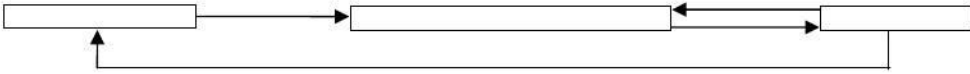
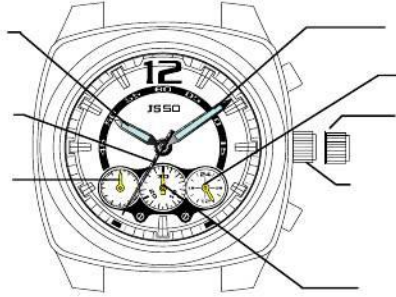

# MIYOTA

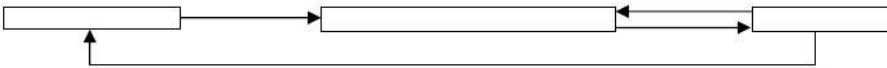
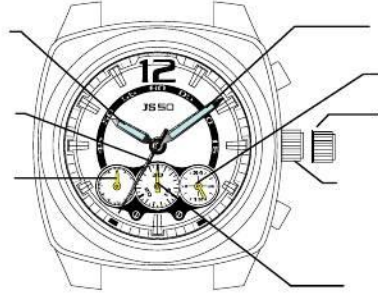

# MIYOTA

---

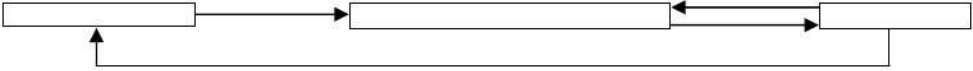
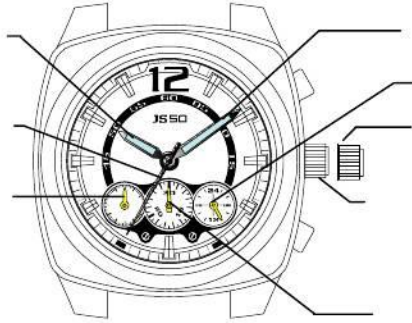

# MIYOTA

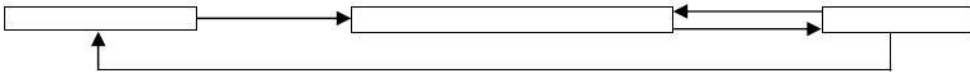
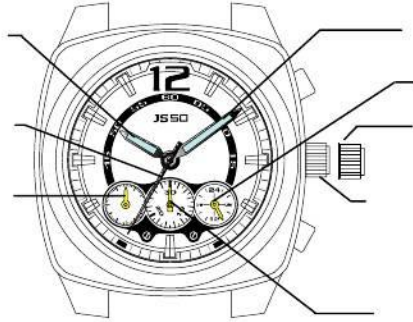

# MIYOTA

