

TECHNICAL INFORMATION

CITIZEN QUARTZ

Cal. No. 7400✽

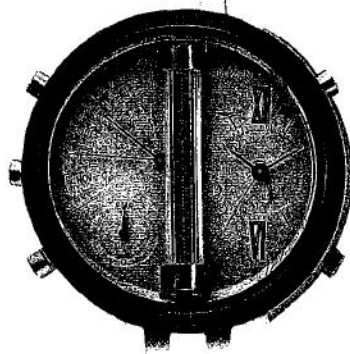

 **CITIZEN**

Contents

§1. FEATURES OF THIS WATCH	1
1. Features	1
2. This watch has the following functions.....	1
§2. SPECIFICATIONS	2
§3. NAME OF EACH PART	3
§4. HOW TO CHANGE THE MODE	4
§5. HOW TO CALL THE CALENDAR	4
§6. EACH RECEIVING MODE	5
1. Automatic receiving function.....	5
2. Forced receiving function	5
3. Precautions for receiving the radio wave in Japan	6
4. Receiving result confirming function	6
5. Estimated areas where radio wave is receivable	7
6. Areas where radio wave is difficult to receive.....	8
7. For better receiving	8
8. Reset of receiving	8
§7. MANUAL CORRECTION METHOD OF TIME AND CALENDAR IN EACH RECEIVING MODE (EUR-UK-JPN)	9
1. Manual correction method of time	9
2. Manual correction method of calendar	10
3. One-touch summer time changeover/Summer time confirmation function	11
§8. USING METHOD OF LOCAL TIME	12
§9. ZERO POSITION CONFIRMATION MODE	12
1. How to confirm zero position.....	12
2. Correcting method of zero position	13
§10. COUNTERMEASURES AGAINST TROUBLES	14
§11. HOW TO REPLACE THE POWER CELL	15
§12. HOW TO MEASURE THE CURRENT CONSUMPTION	17
§13. HOW TO INSTALL THE HANDS	19
§14. HOW TO REPLACE THE ANTENNA	21
§15. HOW TO INSTALL THE GLASS	22
§16. DISASSEMBLY AND ASSEMBLY OF THE MODULE	23
§17. INSPECTION AND ADJUSTMENT METHOD OF MODULE	27
§18. RECEIVING	32

§1. FEATURES OF THIS WATCH

1. Features

- This watch has a device to receive the three standard time radio wave of Japan, Middle Europe, and United Kingdom, which was developed for the first time in the world.
- In a receiving area, this watch receives the time information based on an atomic clock once a day to control the time indicated by itself. Accordingly, its accuracy is kept high.
- Even if any radio wave cannot be received, the average monthly error is ± 15 seconds.
- If any one of the above three radio waves is received, the times and calendars in the other modes are automatically corrected.

2. This watch has the following functions.

- Middle Europe mode (EUR)
- United Kingdom mode (UK)
- Japan mode (JPN)

In these three modes, the time can be corrected by receiving the standard time radio wave.

- Automatic receiving function
- Forced receiving function

- Local time 1 mode
- Local time 2 mode

In these two modes, the time cannot be corrected by receiving the standard time radio wave.

§2. SPECIFICATIONS

Caliber No.		7400-16M
Model name		Analog multi-hand
Module size (mm)		ø35mm x 5.4mm (Date dial guard: 5.9mm)
Time accuracy (At normal temperature)		±15 sec/month (Non-receiving mode), at 5°C ~ -35°C
Quartz frequency		32,768Hz
Indication method		7 hands
IC		C/MOS-LSI 1 pc.
Operating temperature range		-10°C ~ 60°C (14°F ~ 140°F)
Converter		4 motors (Time motor, second motor, function hand-I motor, Function hand-II motor)
Time adjustment		D. F. C.
Measurement gate		10-sec gate
Functions	EUR, UK, JPN mode (Europe, United Kingdom, Japan)	Convert and indicate time and calendar from UTC time
	Receiving function (EUR/UK/JPN)	Automatic receiving function (At 2:00 AM on every even day and at 4:00 PM on every odd day)), forced receiving function
	Receiving result confirmation function	Indicates latest receiving result in automatic and forced receiving modes.
	Calendar function	No adjustment is required at each end of month if number of years after a leap year is set.
	Summer time changeover	
Additional function		<ul style="list-style-type: none"> • Power cell life forecast device • Hand position memory function • In-receiving operation indicating function
Power cell	Part No.	280-206
	Power cell symbol	CR
	Size	ø20.0 x 1.6
	Nominal voltage	3.0V
	Nominal capacity	72mAH
	Life	Approx. 2 year
Current consumption		1.9μA
Coil resistance		Motor A, B, C, D: 2.2KΩ
Remarks		Motor A: Time (Hour, Minute, 24H) motor Motor B: Second hand motor Motor C: Function hand-I motor Motor D: Function hand-II motor

◀The specifications are subject to change.▶

§3. NAME OF EACH PART

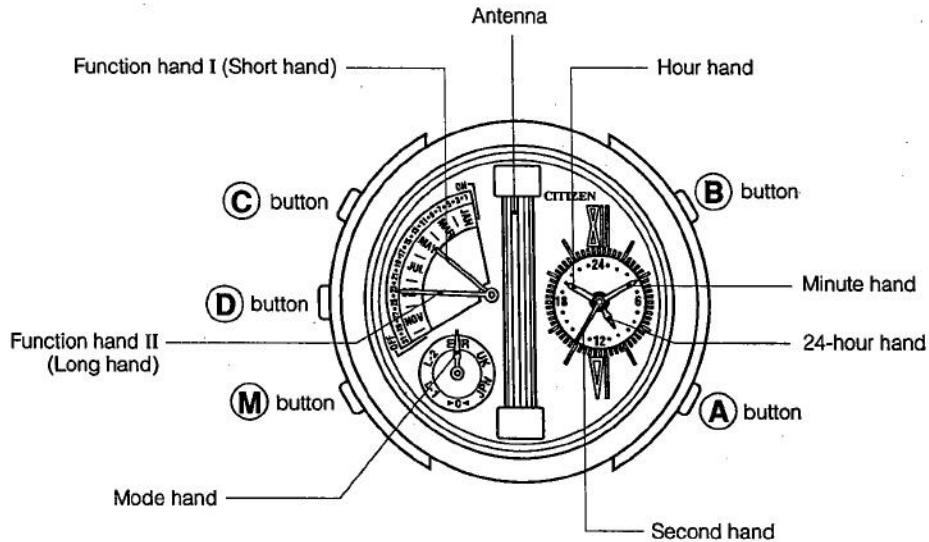

This drawing shows the calendar indicated by the watch.

* Function hand I (short hand): Indicates "month". (May)

Function hand II (long hand): Indicates "day". (23rd)

The normal time is indicated in the following two methods.

*1 The summer time can be set to this watch. (For the setting method of the summer time, see pages 9.)

When the summer time is not set

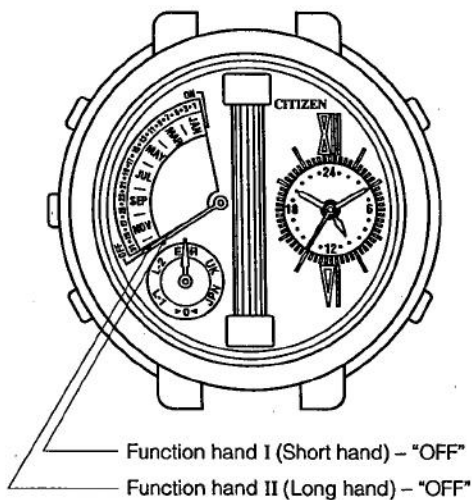

When the summer time is set

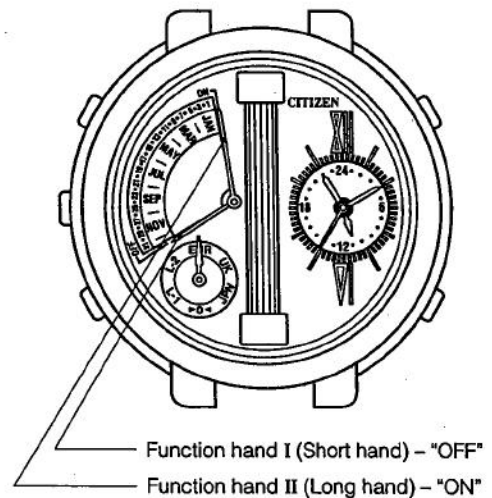

*1. Summer time: A system to advance each watch by 1 hour in the summer to utilize the daytime effectively. This system is not employed in Japan, however. This system is also called the daylight saving time.

§4. HOW TO CHANGE THE MODE

- Every time the **M** button is pushed, the mode (function) is changed in the following order.

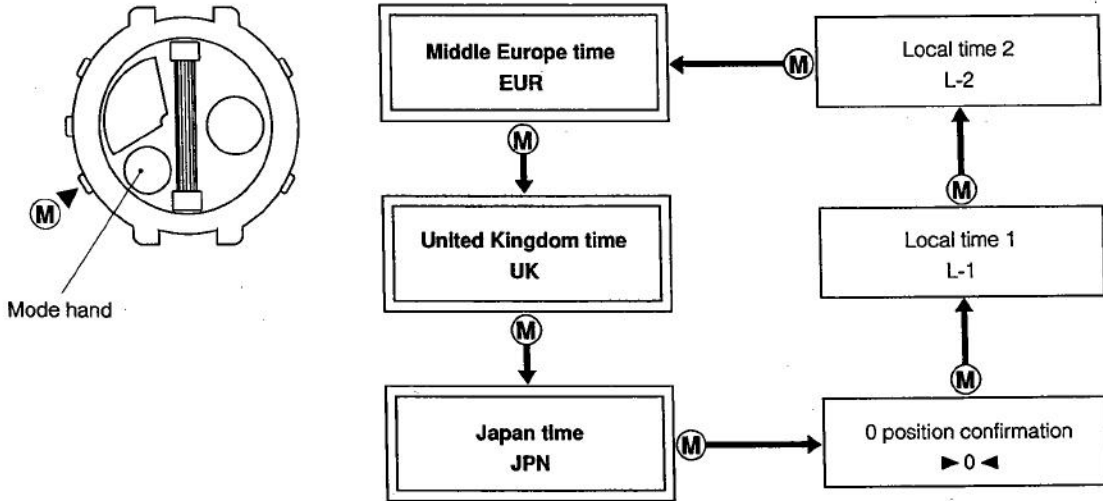

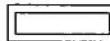
 : In these modes, the standard time radio wave can be received. (Receiving mode)

§5. HOW TO CALL THE CALENDAR

- In the normal indication state of each time mode, the calendar is indicated only while the **C** button is pushed.

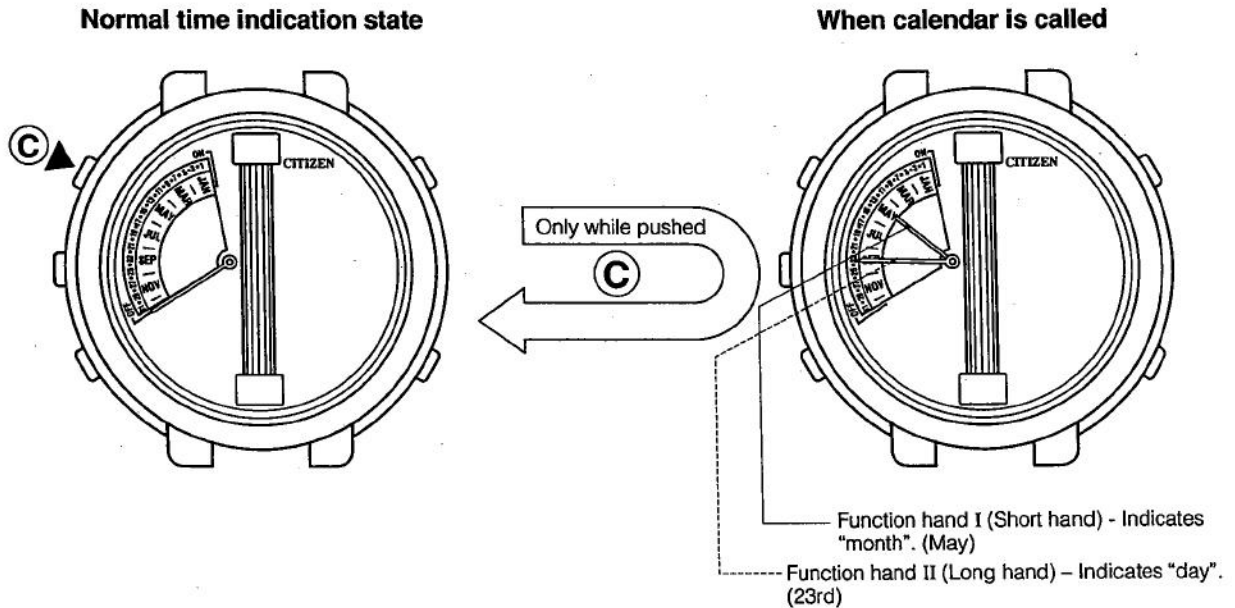

§6. EACH RECEIVING MODE

- This watch has a device to receive the three standard time radio waves of Middle Europe, United Kingdom, and Japan.
When receiving any of those radio waves, use the watch in the proper area mode.
(Middle Europe — EUR mode, United Kingdom — UK mode, Japan — JPN mode)
- If any of the above radio waves is received and the time is corrected, the times in the other areas are also automatically corrected.

1. Automatic receiving function

Watch during receiving operation

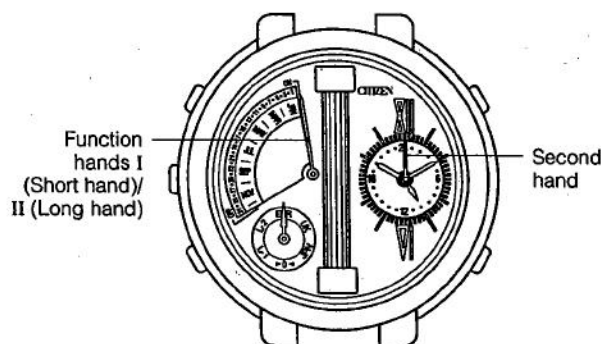

- This watch automatically receives the standard time radio wave every day in the midnight and early morning when the radio wave is relatively stabilized.

Receiving time Every even day 2: 00 AM
 Every odd day 4: 00 AM

Indication during receiving operation:

The second hand stops at 0 second position and the function hands I (short hand)/II (long hand) point "ON" position.

* The hour, minute, and 24-hour hands indicate the present time.

2. Forced receiving function

- This watch has the function to receive the standard time radio wave at any time, as well as the automatic receiving function.
If the (A) button is pushed and hold for 1 second in any receiving mode, the watch receives the standard time radio wave.

Normal time indication

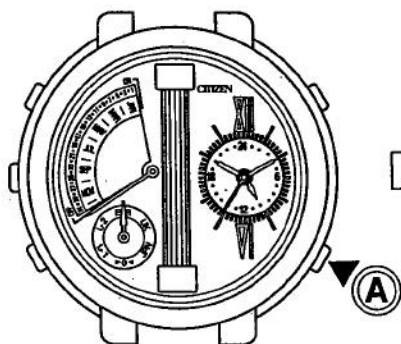

Receiving operation

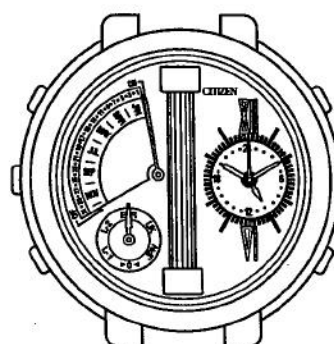

- While receiving the radio wave, the second hand stops at 0 second position and the function hands I (short hand)/II (long hand) point "ON".
- The watch receives the radio wave for about 2 minutes ~ 8 minutes. If the receiving operation is finished, the watch returns to the normal time indication, regardless of the result of receiving.
- Even if any radio wave is not received, the time and calendar before the receiving operation are kept, thus you may perform the forced receiving safely. (For the confirmation of the receiving result, see page 6.)
- * The hour, minute, and 24-hour hands indicate the present time during the receiving operation.

3. Precautions for receiving the radio wave in Japan

- The standard time radio wave in Japan which this watch receive is transmitted from an experimental station on the experimental basis by the General Communication Laboratory of the Ministry of Posts and Telecommunications, and it is not assured that this radio wave will be transmitted continuously as it is in the future.

Even if the transmission of the radio wave is stopped or its form is changed in the future, however, this watch can be used as an ordinary quartz watch (Accuracy: ± 15 sec/month).

Since this watch has the system to receive the standard time radio wave of the Middle Europe and United Kingdom, it can be used as a radio wave receiving watch in the areas where those radio waves can be received.

Precautions for receiving

- The standard time radio wave of Japan can be received at any time in 24 hours as a rule. Since the transmitting station is an experimental one, however, the call sign of JG2AS may be transmitted for 1 minute after 15 minutes and 45 minutes every hour. Accordingly, the standard time radio wave cannot be received during those periods.
- The standard time radio wave of Japan contains only the integrated number of days as the calendar data (number of days after January 01). Accordingly, when setting the time and calendar for the first time by receiving the radio waver, manually set how many years is it since the last leap year. If the time and calendar have been set manually or by receiving the radio wave in another receiving area, the above operation in the "JPN mode" is not required. (For the setting method of number of years after the last leap year, see page 10.)

4. Receiving result confirming function

- The result of the auto receiving or forced receiving can be confirmed by this function. In the normal time indication state of each receiving mode, **only while the \textcircled{B} button is pushed**, the latest receiving result is indicated.

Normal time indication state

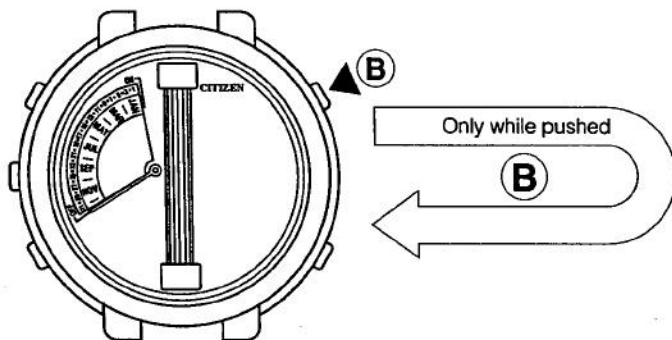

When received successfully

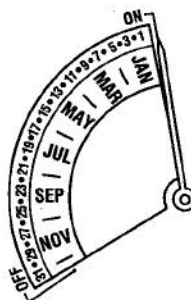

When received unsuccessfully



- While the receiving result is confirmed, the function hand I (short hand) keeps pointing "ON".
If the receiving was successful, the function hand II (long hand) points "ON".
If the receiving is unsuccessful, the function hand II (long hand) points "OFF".
- If it receiving was unsuccessful, the watch indicates the time and calendar before the receiving operation.

5. Estimated areas where radio wave is receivable

- The estimated areas where this watch can receive the standard time radio wave are as follows. Those area may be reduced, however, depending on the conditions of the atmosphere, season, and receiving environment.

Receiving mode	Standard time radio wave transmitting station	Address of transmitting station	Area where radio wave is receivable
EUR (Middle Europe)	DCF77	MAINFLINGEN (25 km south-east of Frankfurt), Germany	Radius of about 800 km (Radio wave may not be received normally around Lake Lemman, however.)
UK (United Kingdom)	MSF	RUGBY, United Kingdom	Radius of about 800 km
JPN (Japan)	JG2AS	Sanwa-cho, Ibaragi-prefecture Japan	Radius of about 500 km

United Kingdom mode

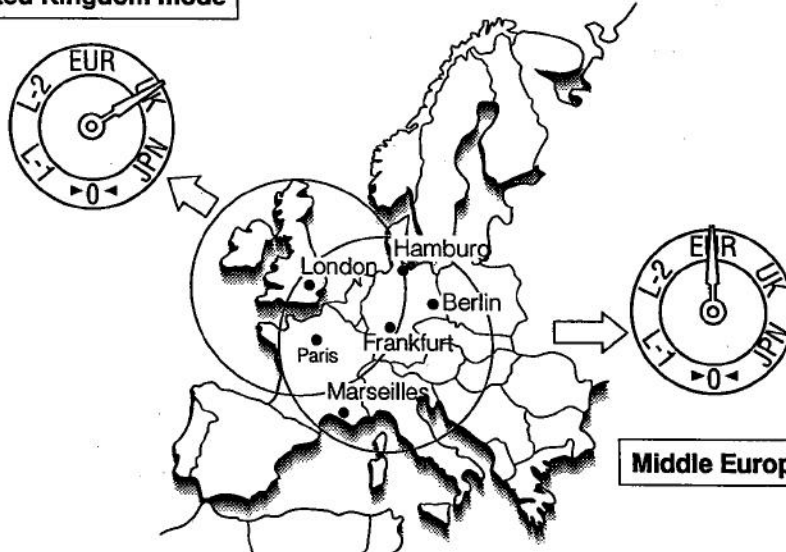

Middle Europe mode

Japan mode

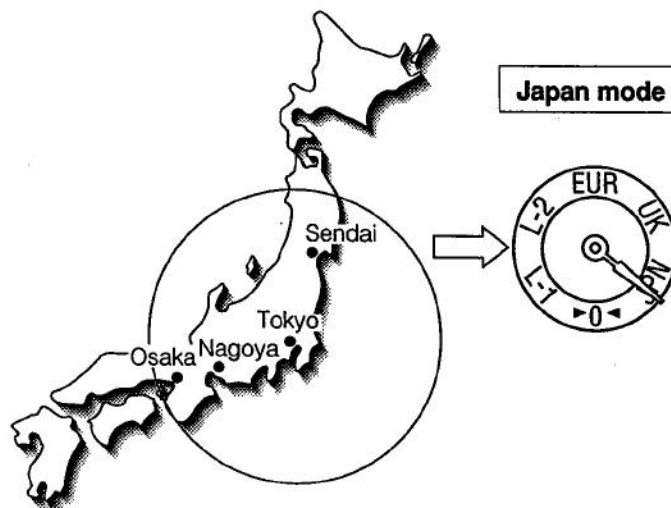

6. Areas where radio wave is difficult to receive

- Avoid receiving the standard time radio wave near an item which generates radio wave noises. The standard time radio wave may not be received normally under the following conditions.
 - (1) Inside a building or between buildings
 - (2) Inside a car or a train, airplane
 - (3) Near high-voltage lines or feed cables of trains
 - (4) Near TV, refrigerator, personal computer, facsimile, various office-automation devices, etc.

If any trouble occurs in receiving under the above conditions, receive again in a better place for receiving.

7. For better receiving

- Radio waves are blocked by metals. Accordingly, when receiving the standard time radio wave in a reinforced concrete building, etc., bring the watch near a window.
- Do not move the direction of the antenna much during the receiving operation for more stable receiving.

(Example)

Automatic receiving Take off the watch and place it in a place where a stronger radio wave can be received before going to bed.

Forced receiving Take off the watch temporarily, or keep the direction of the antenna constant as much as possible.

- If the three or nine o'clock point of the watch is directed toward a transmitting station, a stronger radio wave is received. This method is not effective, however, in a building etc. Accordingly, change the direction of the antenna to find the best direction for receiving.

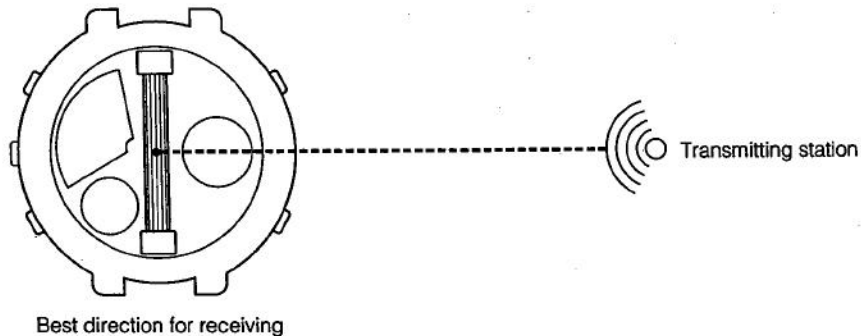

8. Reset of receiving

- While the watch is in the automatic or forced receiving operation, the receiving operation is reset by changing the mode with the **(M)** button or pushing any other button for about 1 second. The receiving operation is reset and the watch returns to the normal indication mode.

Watch in receiving operation

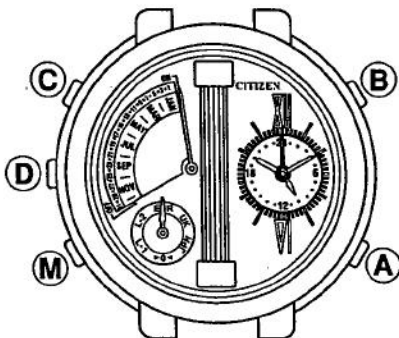

Watch in normal time indicating operation

Change the mode with the **(M)** button or push and hold any other button for 1 second.

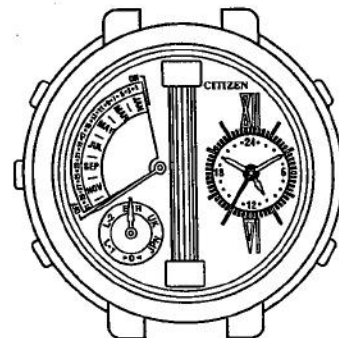

§7. MANUAL CORRECTION METHOD OF TIME AND CALENDAR IN EACH RECEIVING MODE (EUR-UK-JPN)

1. Manual correction method of time

- Even if this watch cannot receive the standard time radio wave, it can be set to the correct time by manual operation.

1.

Pull out the **(M) button.**

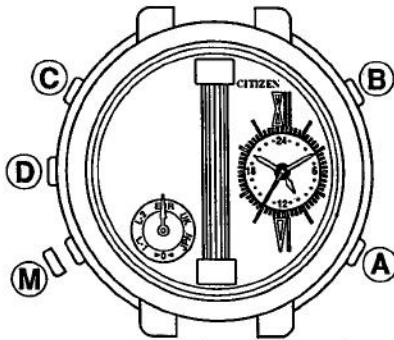

Push the **(A)** button to set the second hand to zero position.

Correct the hour, minute, and 24-hour hands with the **(B)** button

2.

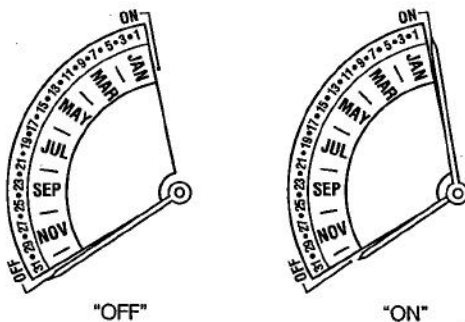

- If the summer time is applied, set the function hand II (long hand) to "ON" with the **(C)** button.
 - If the former is not applied, set the latter to "OFF".
- The function hand I (short hand) keeps pointing "OFF".

3.

Return the **(M) button to the normal position.**

While the **(M)** button is pulled out, if the **(D)** button is pushed, the function hands I (short hand)/II (long hand) can be set to the number of years after the last leap year.

2. Manual correction method of calendar

- Even if the standard time radio wave cannot be received, the calendar of this watch can be set manually.

1.

Pull out the **(M) button.**

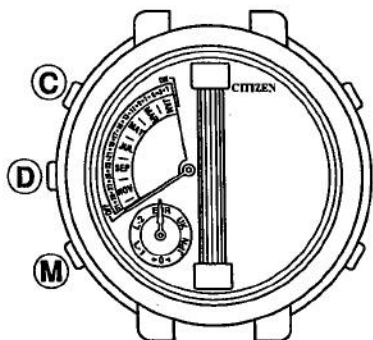

Push the **(D)** button once.

(The function hands I (short hand)/II (long hand) indicate any position between "ON" and "3rd").

2.

Correct the number of years after the last leap year with the **(C) button [It is indicated by the function hand I (short hand)/II (long hand)].**

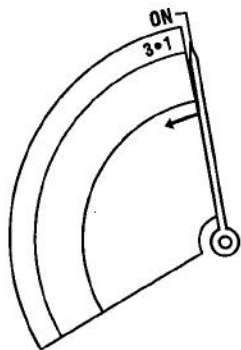

"ON" Leap year

"1st" First year after leap year

"2nd" Second year after leap year

"3rd" Third year after leap year

3.

Push the **(D) button once.**

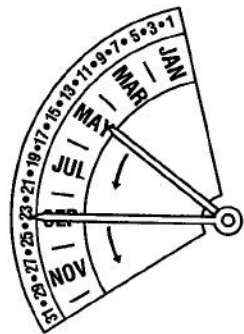

The function hands I (short hand)/II (long hand) are set for correction of month and date.

Correct the month and day simultaneously with the **(C)** button.

4.

Return the **(M) button to the normal position**

3. One-touch summer time changeover/Summer time confirmation function

- This watch can be set for summer time system in each of normal time modes (EUR/UK/JPN) and local time 1 and 2 modes

Push the **(M)** button and set the watch to the required mode of "EUR", "UK", "JPN", "L-1", and "L-2".

1.

Push the **(D) button.**

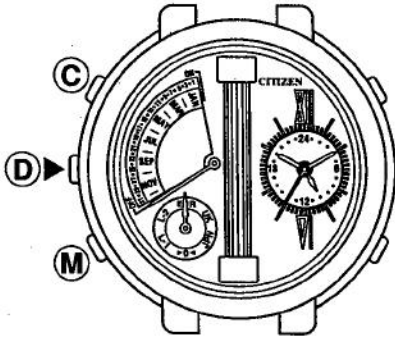

If the **(D)** button is pushed, the watch is advanced by 1 hour to set it for summer time.

If the **(D)** button is pushed again, the summer time is reset.

2.

Setting of the watch for summer time can be confirmed.

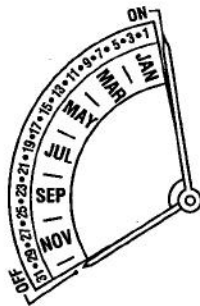

Summer time "ON"



Summer time "OFF"

§8. USING METHOD OF LOCAL TIME

- This watch can show local times 1 and 2, in addition to the times in the three countries (EUR/UK/JPN).

The standard time radio wave cannot be received in the local time 1, 2 modes, however.

Each local time can be corrected on the unit of 1 hour.

1. Push the **(M)** button to set the mode hand to "L-1" or "L-2".

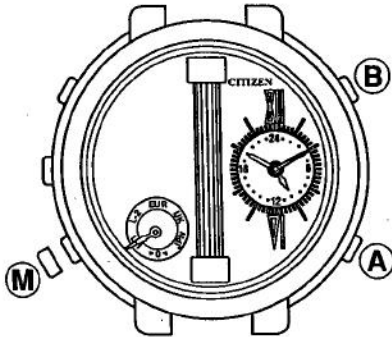

If the **(A)** button is pushed, the hour, minute, and 24-hour hands move counterclockwise (Feeding by -1 hour).

If the **(B)** button is pushed, the hour, minute, and 24-hour hands move clockwise (Feeding by 1 hour).

- In this mode, the second and calendar cannot be corrected.

§9. ZERO POSITION CONFIRMATION MODE

1. How to confirm zero position

- After the power cell is replaced or a large impact is given to the watch, be sure to confirm the base hand position of watch (zero position) in the following mode.

Push the **(M)** button to set the mode hand to "►0◀" mode.

1.

Push the **(M)** button.

The watch is set to "►0◀" mode.

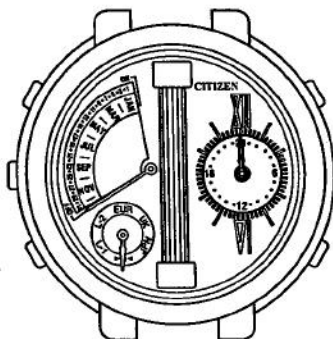

Function hand I (short hand) "OFF"
 Function hand II (long hand) "OFF"
 Hour, minute, and 24-hour hands "24 hours
 0 minute
 0 second"

If the watch is normal, the hands indicate the above positions.

If any hand does not indicate the zero position, correct it according to the method explained in the following page.

2. Correcting method of zero position

- If any hand does not indicate zero position in the zero position confirmation mode, correct it according to the following procedure.

☆ Be sure to correct the zero position in the "▶0◀" mode.

1.

Pull out the (M) button.

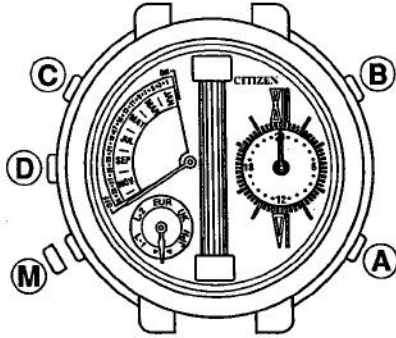

2. Set the second hand to 0 second with the (A) button.

Set the hour, minute, and 24-hour hands to 0 hour 0 minute position with the (B) button.

Set the function hand II (long hand) to "OFF" mark with the (C) button.

Set the function hand I (short hand) to "OFF" mark with the (D) button.

3.

Return the (M) button to the normal position.

After the above setting operation, push the (M) button to set the watch in a proper area mode and receive the standard time radio wave.

If the watch is in an area where the standard time radio wave can be received, it indicates the present time and calendar several minutes later.

If the watch is in an area where the standard time radio wave cannot be received, correct the time and calendar manually.

How to correct the time when the radio wave cannot be received → See page 9.

How to correct the calendar when the radio wave cannot be received → See page 10.

§10. COUNTERMEASURES AGAINST TROUBLES

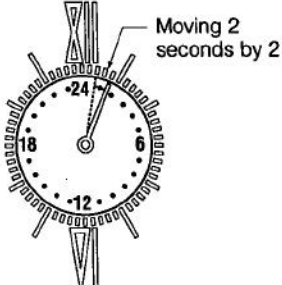
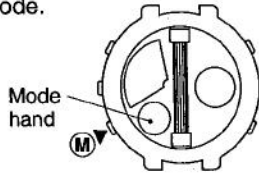
Trouble	Checkpoint	Countermeasures
Watch cannot be set in receiving mode	See if the second hand moves as shown below (Power cell life forecast). 	<ul style="list-style-type: none"> If the second hand moves as shown at left, the power cell is almost dead. Ask the shop you bought your watch of a shop where Citizen Quartz Watches are sold to replace the power cell.
Watch cannot receive radio wave.	<ul style="list-style-type: none"> See if a proper district mode is selected? See if the watch is out of a district where it can receive the radio wave. 	<ul style="list-style-type: none"> Push the (M) button to select a proper district mode.  <ul style="list-style-type: none"> See "6-5. Estimated areas where radio wave is receivable" to confirm districts where the watch can receive radio wave.
Watch cannot receive radio wave (in a place where it could receive before).	<ul style="list-style-type: none"> Check for something which blocks radio wave or generates noises. 	<ul style="list-style-type: none"> See "6-6. Areas where radio wave is difficult to receive" to check the precautions for receiving radio wave. See "6-7. For better receiving". See if the receiving environment has been changed because of relocation of furnitures.
Radio wave is surely received but watch does not indicate correct time	<ul style="list-style-type: none"> See if each hand of the watch indicates the "0" position in the "0 position conformation mode". (▶◀) Check for something which blocks radio wave or generates noises. See if the watch is on a border of a district where it can receive radio wave. 	<ul style="list-style-type: none"> See "9-2. Correcting method of zero position" to set each hand to the "0" position. See "6-6. Areas where radio wave is difficult to receive" and receive again.
Watch operates abnormally.	<ul style="list-style-type: none"> The hands do not stop turning. The watch has stopped without any sign. The push buttons do not work. Other abnormal operations (except the 2-second movement of the second watch for power cell life forecast). 	<ul style="list-style-type: none"> Hold down the four buttons of (A), (B), (C), and (D) for 2 or more seconds, then release them at the same time. <p>CAUTION After the above operation, be sure to see 9-2. "Correcting method of zero position" to set each hand to the "0" point.</p> 