

SEIKO WATCH CORPORATION

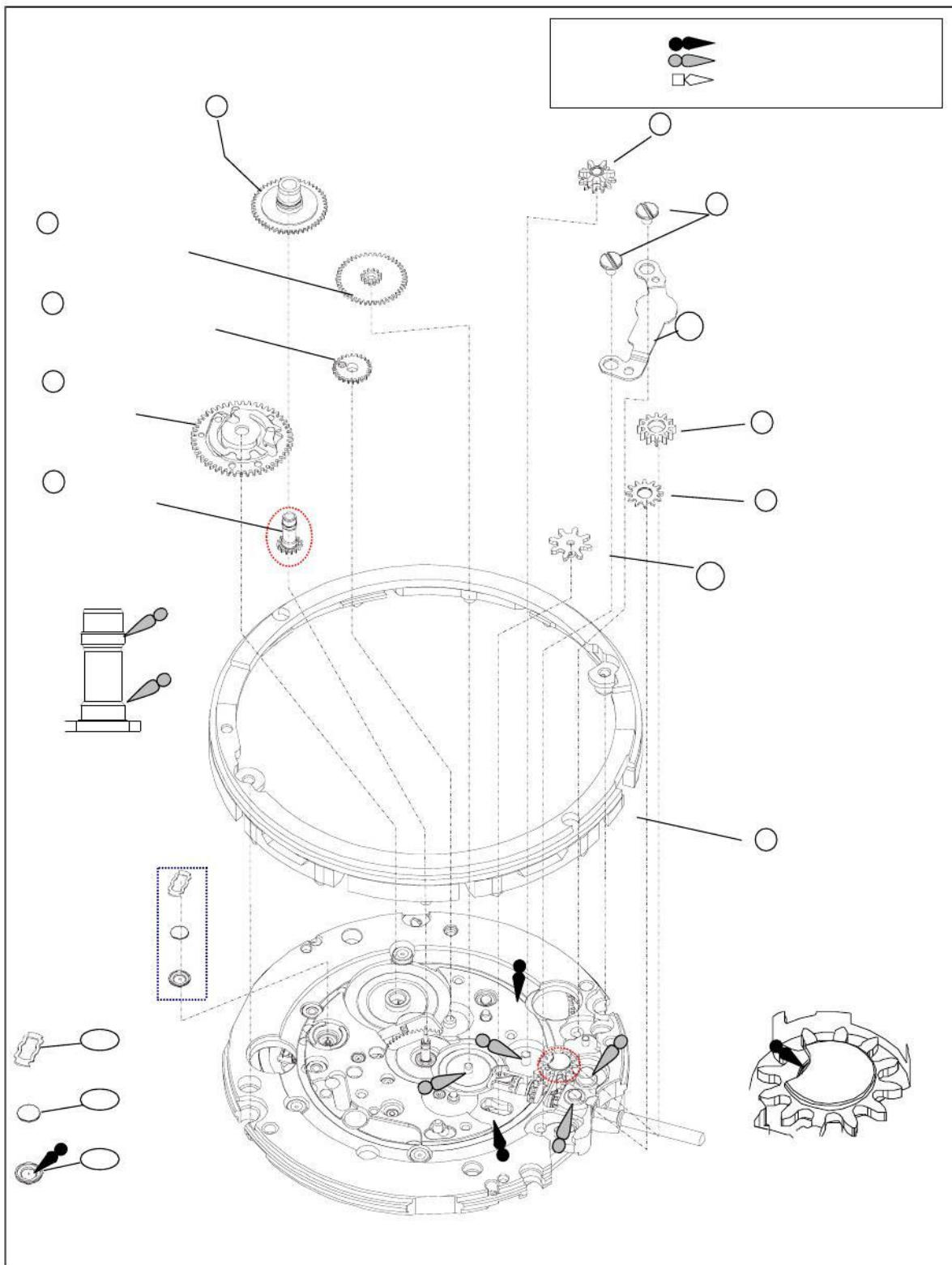

SEIKO WATCH CORPORATION

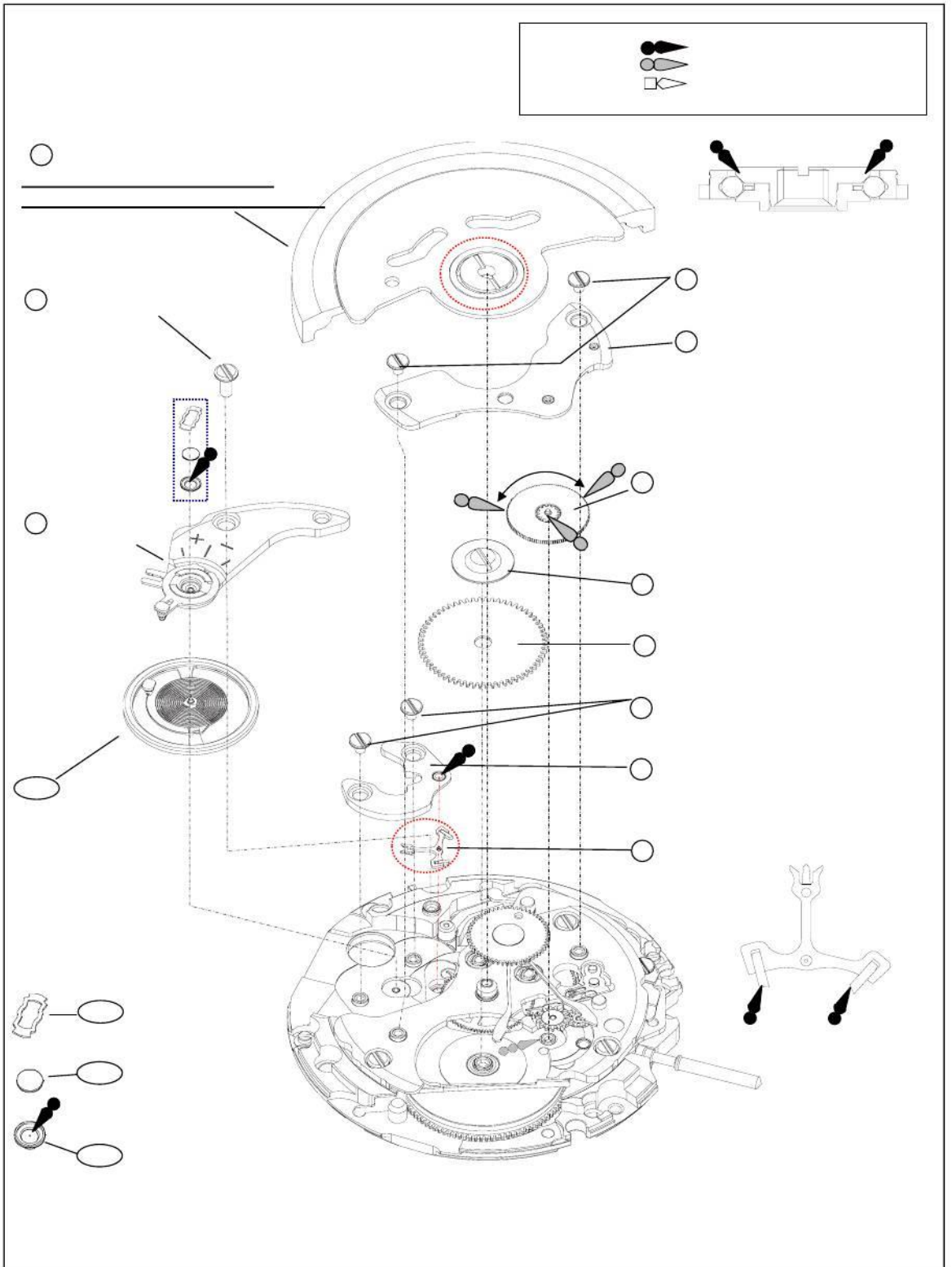

SEIKO WATCH CORPORATION

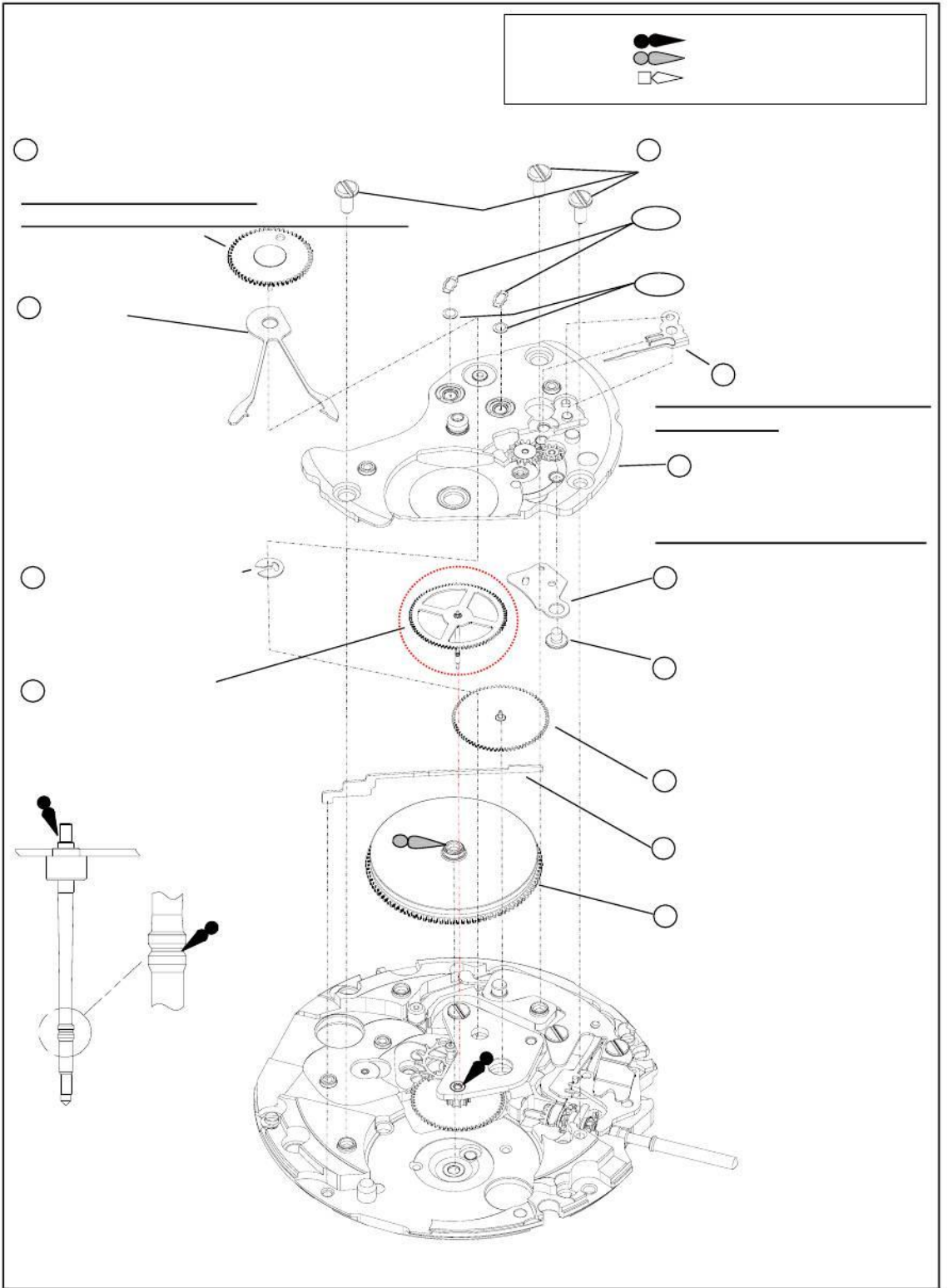

SEIKO WATCH CORPORATION

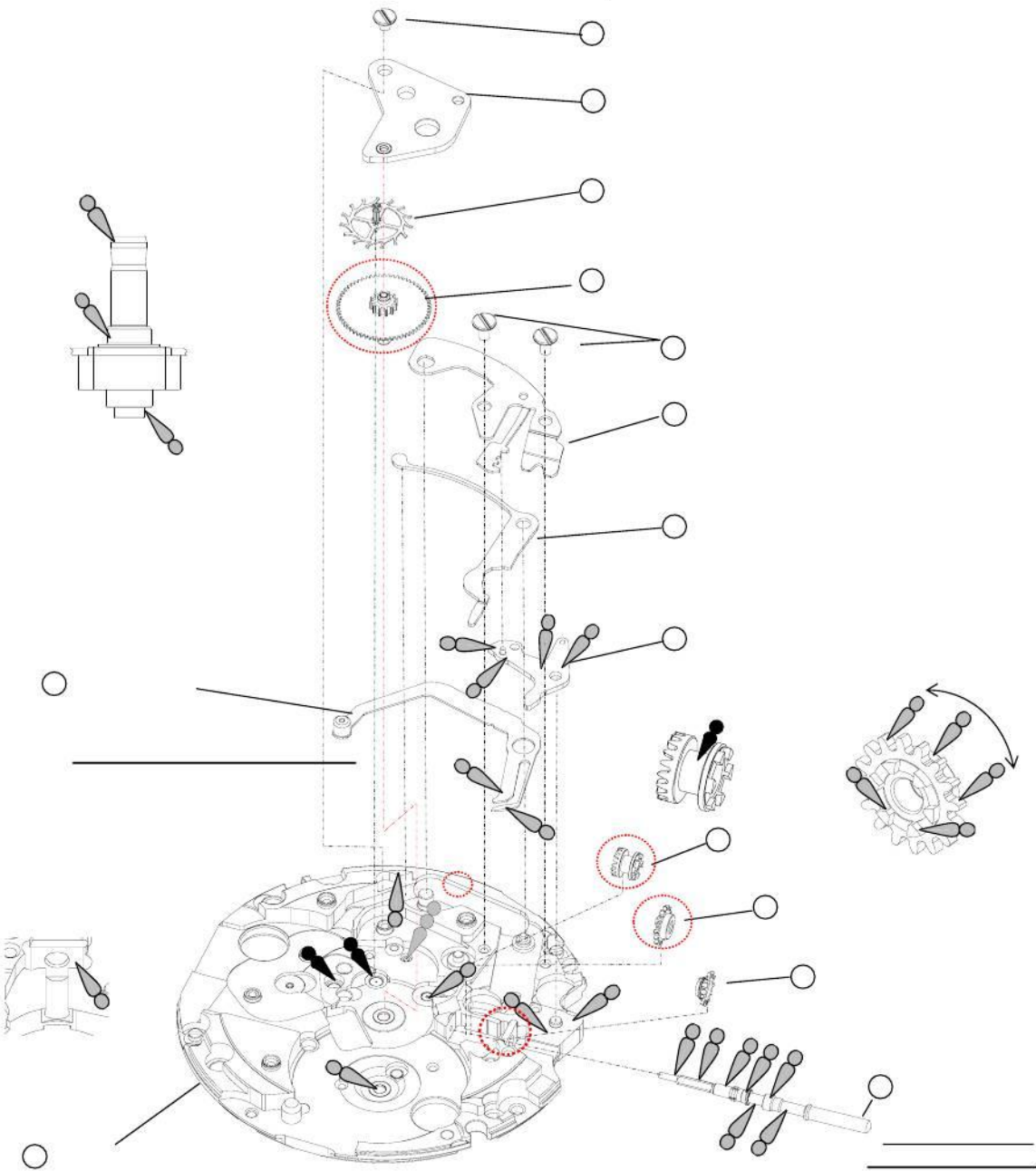
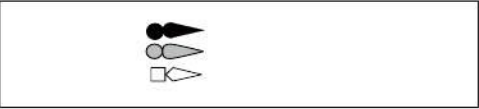

SEIKO WATCH CORPORATION

--





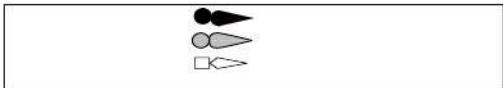

○

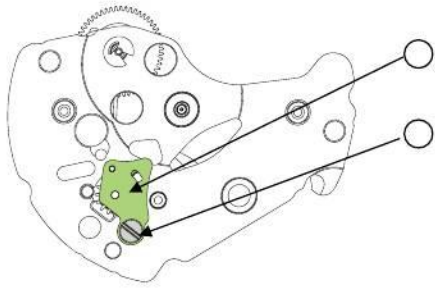
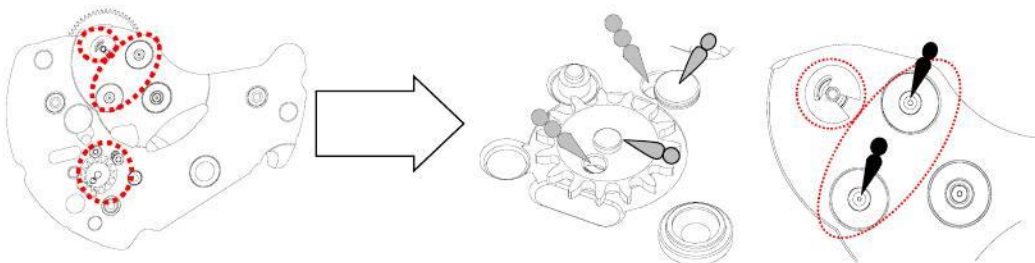
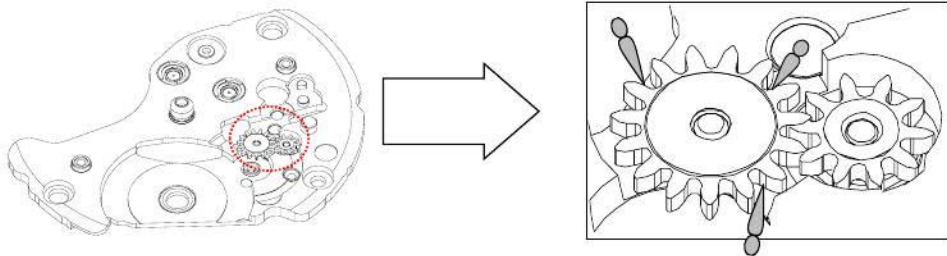

○

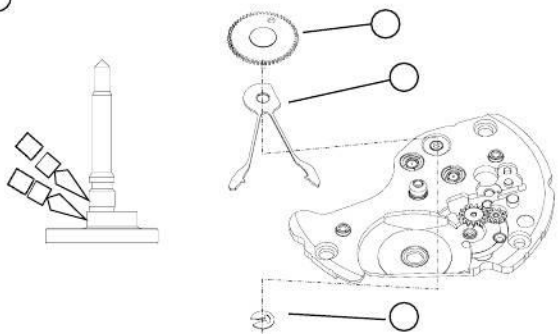

○

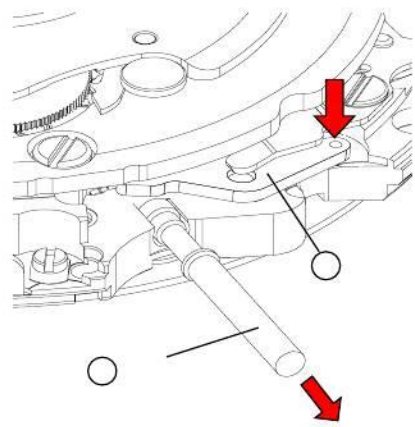
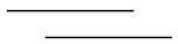
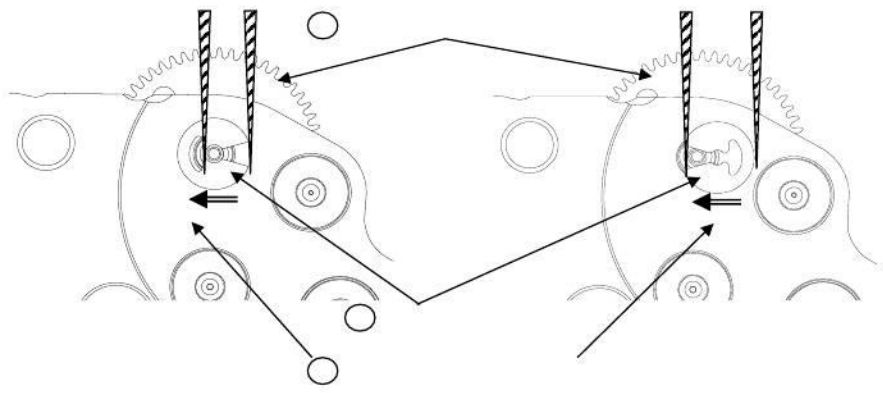
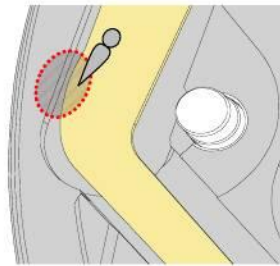
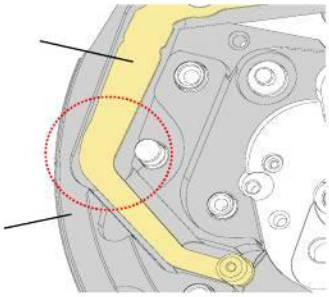

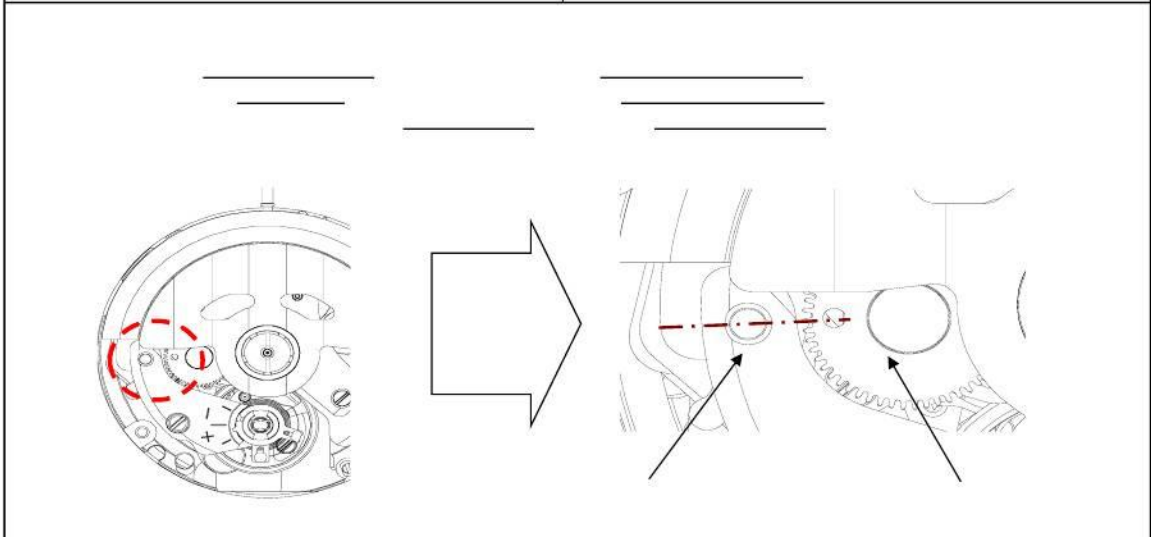
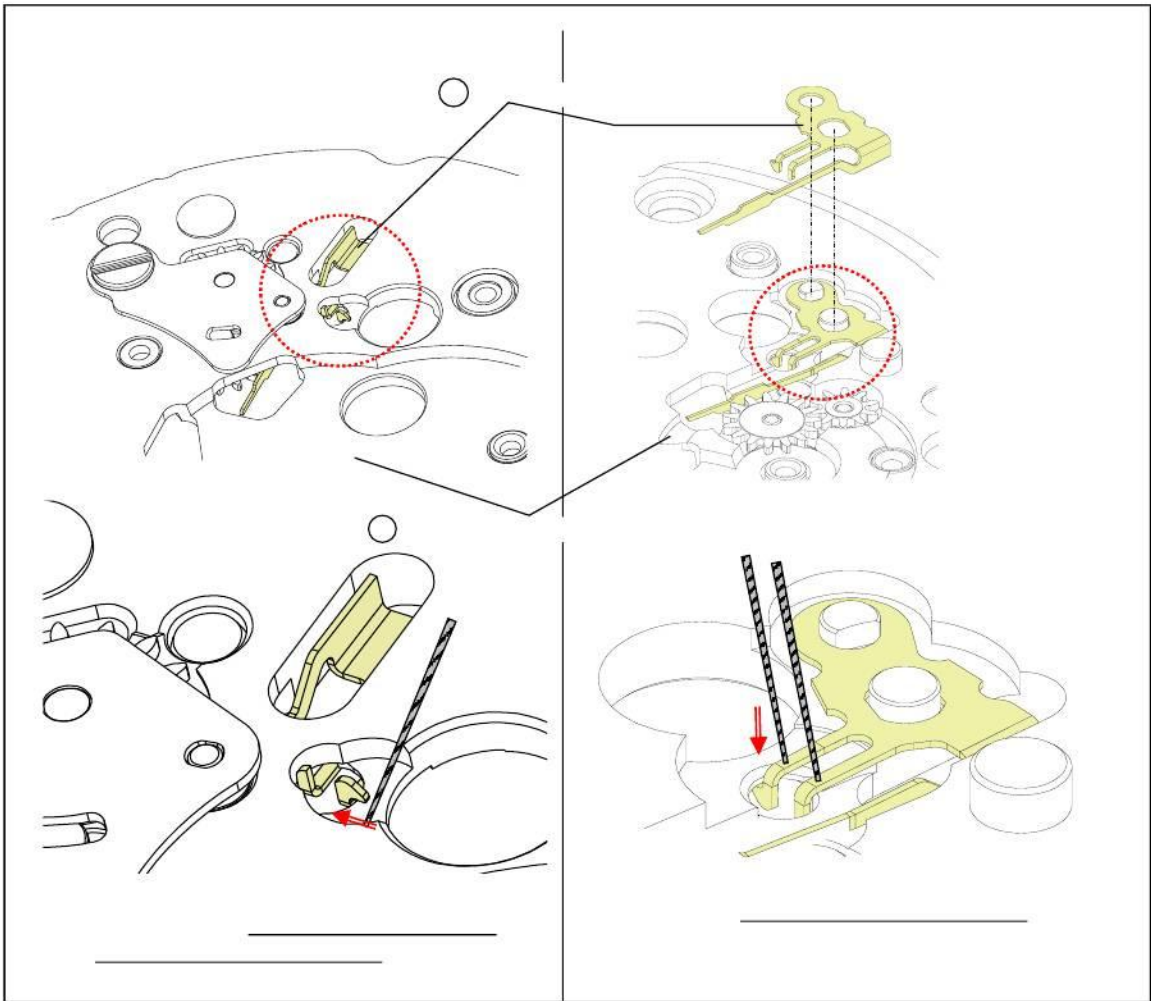

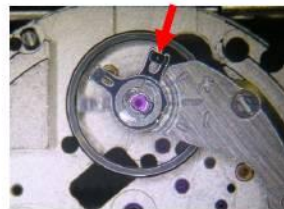
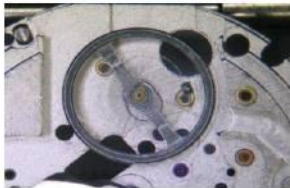
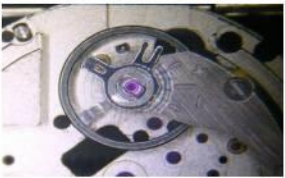
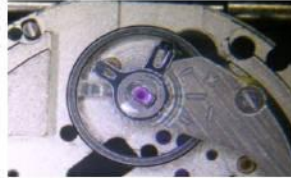
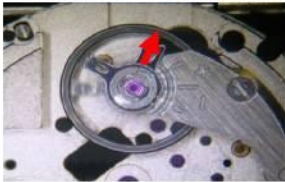
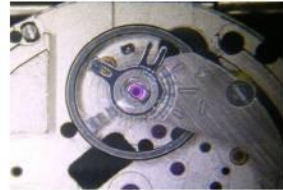
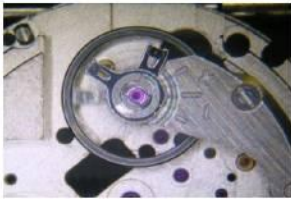
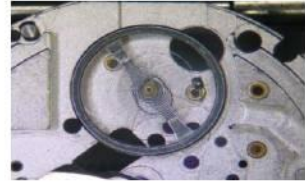
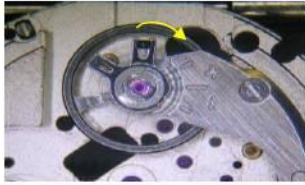

SEIKO WATCH CORPORATION

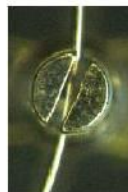
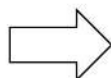
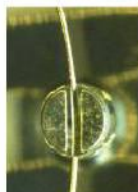
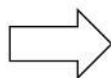
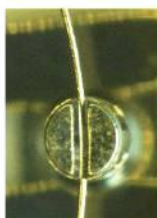
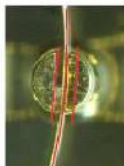

SEIKO WATCH CORPORATION

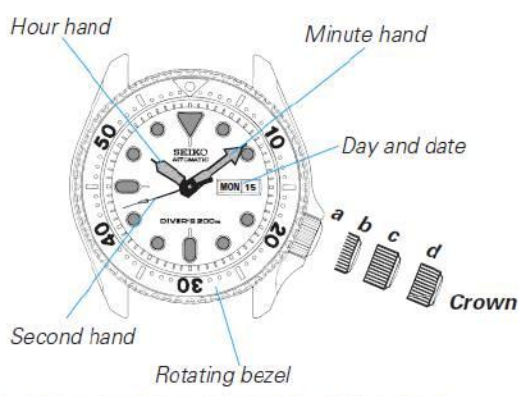
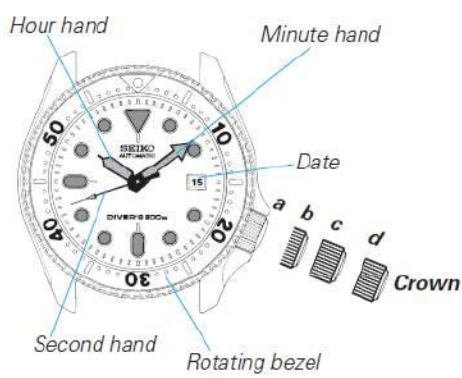

a: Screwed-in position b: Normal position c: First click d: Second click

	<input type="text"/>	
	<input type="text"/>	
	<input type="text"/>	
	<input type="text"/>	
	<input type="text"/>	
	<input type="text"/>	
