

Congratulations upon your selection of this CASIO watch.

## Applications

The built-in sensors of this watch measure direction, barometric pressure, temperature and altitude. Measurement results are indicated by the second hand of the watch and on the digital display. Such features make this watch useful when hiking, mountain climbing, or when engaging in other such outdoor activities.

### Warning !

- The measurement functions built into this watch are not intended for taking measurements that require professional or industrial precision. Values produced by this watch should be considered as reasonable representations only.
- When engaging in mountain climbing or other activities in which losing your way can create a dangerous or life-threatening situation, always use a second compass to confirm direction readings.
- Note that CASIO COMPUTER CO., LTD. assumes no responsibility for any damage or loss suffered by you or any third party arising through the use of this product or its malfunction.

E-1

## About This Manual



- Depending on the model of your watch, display text appears either as dark figures on a light background, or light figures on a dark background. All sample displays in this manual are shown using dark figures on a light background.
- Button operations are indicated using the letters shown in the illustration.
- Note that the product illustrations in this manual are intended for reference only, and so the actual product may appear somewhat different than depicted by an illustration.



E-2

## Things to check before using the watch

### 1. Hold down **(D)** for about two seconds to enter the Timekeeping Mode, and then observe the movement of the second hand.

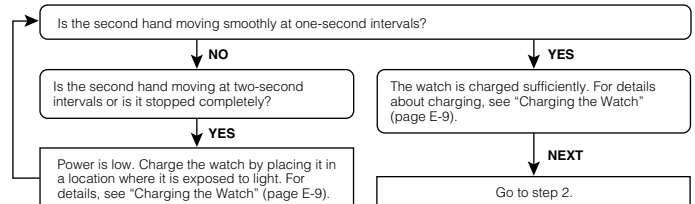

### 2. Check the Home City and the daylight saving time (DST) setting.

Use the procedure under "To configure Home City settings" (page E-28) to configure your Home City and daylight saving time settings.

#### Important!

Proper time calibration signal reception and World Time Mode data depend on correct Home City, time, and date settings in the Timekeeping Mode. Make sure you configure these settings correctly.

E-3

## 3. Set the current time.

- To set the time using a time calibration signal  
See "To get ready for a receive operation" (page E-18).
- To set the time manually  
See "Configuring Current Time and Date Settings Manually" (page E-31).

### The watch is now ready for use.

- For details about the watch's radio controlled timekeeping feature, see "Radio Controlled Atomic Timekeeping" (page E-15).

E-4

## Contents

<b>E-2</b>	<b>About This Manual</b>
<b>E-3</b>	<b>Things to check before using the watch</b>
<b>E-9</b>	<b>Charging the Watch</b>
E-14	To recover from the sleep state
<b>E-15</b>	<b>Radio Controlled Atomic Timekeeping</b>
E-18	To get ready for a receive operation
E-20	To perform manual receive
E-21	To check the latest signal reception results
E-21	To turn auto receive on and off
<b>E-23</b>	<b>Mode Reference Guide</b>
<b>E-27</b>	<b>Timekeeping</b>
<b>E-28</b>	<b>Configuring Home City Settings</b>
E-28	To configure Home City settings
E-30	To change the Daylight Saving Time (summer time) setting
<b>E-31</b>	<b>Configuring Current Time and Date Settings Manually</b>
E-31	To change the current time and date settings manually

E-5

## E-34 Taking Direction Readings

- E-34 To take a direction reading
- E-37 To perform magnetic declination correction
- E-38 To perform bidirectional calibration
- E-39 To perform northerly calibration
- E-40 To set a map and find your current location
- E-42 To find the bearing to an objective

## E-44 Taking Barometric Pressure and Temperature Readings

- E-44 To enter and exit the Barometer/Thermometer Mode
- E-45 To take barometric pressure and temperature readings
- E-50 To calibrate the pressure sensor and the temperature sensor

## E-52 Taking Altitude Readings

- E-53 To take an altimeter reading
- E-55 To select the altitude auto measurement method
- E-59 To change the altitude differential scale step unit
- E-59 To set the altitude differential start point
- E-60 To use the altitude differential value
- E-62 To specify a reference altitude value
- E-63 To create a manual save record

## E-69 Specifying Temperature, Barometric Pressure, and Altitude Units

- E-69 To specify temperature, barometric pressure, and altitude units

## E-71 Precautions Concerning Simultaneous Measurement of Altitude and Temperature

E-6

## E-72 Viewing Altitude Records

- E-72 To view altitude records
- E-74 To delete a single altitude record
- E-74 To delete all altitude records

## E-75 Using the Stopwatch

- E-75 To enter the Stopwatch Mode
- E-75 To perform an elapsed time operation
- E-75 To pause at a split time
- E-76 To measure two finishes

## E-77 Using the Countdown Timer

- E-77 To enter the Countdown Timer Mode
- E-77 To specify the countdown start time
- E-78 To perform a countdown timer operation
- E-78 To stop the alarm

## E-79 Using the Alarm

- E-79 To enter the Alarm Mode
- E-80 To set an alarm time
- E-81 To test the alarm
- E-81 To turn an alarm and the Hourly Time Signal on and off
- E-81 To stop the alarm

E-7

## E-82 Checking the Current Time in a Different Time Zone

- E-82 To enter the World Time Mode
- E-82 To view the time in another time zone
- E-83 To specify standard time or daylight saving time (DST) for a city
- E-84 To swap your Home City and World Time City

## E-86 Auto Correction of Hand Home Positions

- E-87 To trigger auto correction of hand home positions

## E-88 Adjusting Home Positions Manually

- E-88 To adjust home positions manually

## E-90 Illumination

- E-90 To turn on illumination manually
- E-91 To change the illumination duration
- E-93 To turn the auto light switch on and off

## E-95 Button Operation Tone

- E-95 To turn the button operation tone on and off

## E-96 Troubleshooting

## E-103 Specifications

E-8

## Charging the Watch

The face of the watch is a solar cell that generates power from light. The generated power charges a built-in rechargeable battery, which powers watch operations. The watch charges whenever it is exposed to light.

### Charging Guide



- Whenever you are not wearing the watch, leave it in a location where it is exposed to light.
  - Best charging performance is achieved by exposing the watch to the strongest light available.



- When wearing the watch, make sure that its face is not blocked from light by the sleeve of your clothing.
  - The watch may enter a sleep state (page E-14) if its face is blocked by your sleeve even only partially.

### Warning!

Leaving the watch in bright light for charging can cause it to become quite hot. Take care when handling the watch to avoid burn injury. The watch can become particularly hot when exposed to the following conditions for long periods.

- On the dashboard of a car parked in direct sunlight
- Too close to an incandescent lamp
- Under direct sunlight

E-9

## Important!

- Allowing the watch to become very hot can cause its liquid crystal display to black out. The appearance of the LCD should become normal again when the watch returns to a lower temperature.
- Turn on the watch's Power Saving function (page E-14) and keep it in an area normally exposed to bright light when storing it for long periods. This helps to ensure that power does not run down.
- Storing the watch for long periods in an area where there is no light or wearing it in such a way that it is blocked from exposure to light can cause power to run down. Expose the watch to bright light whenever possible.

## Power Levels

You can check the current battery power level by viewing the battery power indicator that appears on the digital display when you enter the Timekeeping Mode.

- To enter the Timekeeping Mode from any other mode, hold down **(D)** for about two seconds.

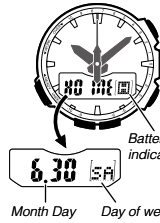

Month Day Day of week

Level	Battery Power Indicator	Function Status
1 (H)		All functions enabled.
2 (M)		All functions enabled.
3 (L)		Signal reception, illumination, tone, sensor, and hand home position correction disabled. Second hand jumps every two seconds.
4		Signal reception, illumination, tone, sensor, and hand home position correction disabled. Blank digital display. Second hand stopped, hour and minute hands stopped at 12 o'clock.
5		All hands stopped at 12 o'clock. All functions disabled.

E-10

E-11

- The flashing **L** indicator at Level 3 tells you that battery power is very low, and that exposure to bright light for charging is required as soon as possible.
- At Level 5, all functions are disabled and settings return to their initial factory defaults. Once the battery reaches Level 2 (M) after falling to Level 5, reconfigure the current time, date, and other settings.
- Display indicators reappear as soon as the battery is charged from Level 5 to Level 2 (M).
- Leaving the watch exposed to direct sunlight or some other very strong light source can cause the battery power indicator to show a reading temporarily that is higher than the actual battery level. The correct battery level should be indicated after a few minutes.
- All data stored in memory is deleted, and the current time and all other settings return to their initial factory defaults whenever battery power drops to Level 5 and when you have the battery replaced.

- Illumination, tones, and sensor operations are disabled and the hands of the watch stop until battery power recovers.
- Battery power takes about 15 minutes to recover. The recovery indicator (R) will stop flashing and normal watch operation will be restored when battery recovery is complete.
- Frequent flashing of the recovery indicator (R) indicates that battery power is low. Expose the watch to light to charge its battery.

## Charging Times

Exposure Level (Brightness)	Daily Operation <sup>*1</sup>	Level Change <sup>*2</sup>				
		Level 5	Level 4	Level 3	Level 2	Level 1
Outdoor sunlight (50,000 lux)	8 min.	2 hours		18 hours	5 hours	
Sunlight through a window (10,000 lux)	30 min.	6 hours		69 hours	19 hours	
Daylight through a window on a cloudy day (5,000 lux)	48 min.	9 hours		111 hours	30 hours	
Indoor fluorescent lighting (500 lux)	8 hours	90 hours		---	---	

<sup>\*1</sup> Approximate amount of exposure time required each day to generate enough power for normal daily operation.

<sup>\*2</sup> Approximate amount of exposure time (in hours) required to take power from one level to the next.

- The above exposure times all are for reference only. Actual exposure times depend on lighting conditions.
- For details about the operating time and daily operating conditions, see the "Power Supply" section of the Specifications (page E-106).

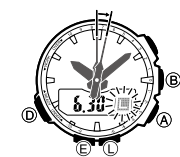

### Charging Required Indication (by second hand)

When battery power reaches Level 3, the second hand of the watch will jump at 2-second intervals in the Timekeeping Mode to let you know that charging is required.

## Power Recovery Mode

- Repeated sensor measurement, illumination, or use of tones over a short period of time may cause the watch to enter a power recovery mode, which is indicated by a recovery indicator (R) to flash on the digital display. The watch will remain in the power recovery mode until battery power recovers.

E-12

E-13

## Power Saving

Power Saving enters a sleep state automatically whenever the watch is left for a certain period in an area where it is dark. The table below shows how watch functions are affected by Power Saving.

- There actually are two sleep state levels: "display sleep" and "function sleep".
- With this watch, the Power Saving function cannot be disabled.

Elapsed Time in Dark	Hands and Display	Operation
60 to 70 minutes (display sleep)	Blank display, second hand stopped at 12 o'clock.	Except for display and second hand, all functions enabled.
6 or 7 days (function sleep)	Blank display, all hands stopped at 12 o'clock.	Except for timekeeping, all functions disabled.

- The watch will not enter a sleep state between 6:00 AM and 9:59 PM. If the watch is already in a sleep state when 6:00 AM arrives, however, it will remain in the sleep state.
- You will not be able to enter the Compass, Barometer/Thermometer, Altimeter, Stopwatch, or Countdown Timer Mode while the watch is in a sleep state.

### To recover from the sleep state

Move the watch to a well-lit area, press any button, or angle the watch towards your face for reading (page E-91).

E-14

## Radio Controlled Atomic Timekeeping

This watch receives a time calibration signal and updates its time setting accordingly. However, when using the watch outside of areas covered by time calibration signals, you will have to adjust the settings manually as required. See "Configuring Current Time and Date Settings Manually" (page E-31) for more information.

This section explains how the watch updates its time settings when the city code selected as the Home City is in Japan, North America, Europe, or China, and is one that supports time calibration signal reception.

If your Home City Code setting is this:	The watch can receive the signal from the transmitter located here:
LONDON (LON), PARIS (PAR), ATHENS (ATH)	Anthorn (England), Mainflingen (Germany)
HONG KONG (HKG)	Shangqiu City (China)
TOKYO (TYO)	Fukushima (Japan), Fukuoka/Saga (Japan)
HONOLULU (HNL), ANCHORAGE (ANC), LOS ANGELES (LAX), DENVER (DEN), CHICAGO (CHI), NEW YORK (NYC)	Fort Collins, Colorado (United States)

### Important!

- The areas covered by HONOLULU (HNL) and ANCHORAGE (ANC) are quite far from the calibration signal transmitters, so certain conditions may cause reception problems.
- When HONG KONG (HKG) is selected as the Home City, only the time and date are adjusted according to the time calibration signal. You need to switch manually between standard time and daylight saving time (DST) if required. See "To configure Home City settings" (page E-28) for information about how to do this.

E-15

## Approximate Reception Ranges

### UK and German Signals

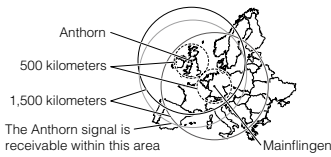

### North American Signal

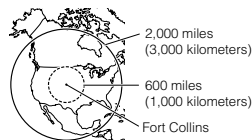

### Japanese Signals

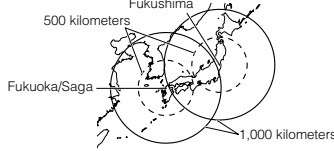

### Chinese Signal

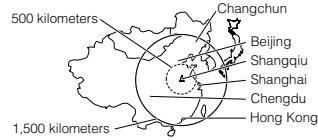

- Even when the watch is within range of a transmitter, signal reception may be impossible due to the effects of geographic contours, structures, weather, the time of year, the time of day, radio interference, etc. The signal becomes weaker at distances of approximately 500 kilometers, which means that the influence of the conditions listed above becomes even greater.
- Signal reception may not be possible at the distances noted below during certain times of the year or day. Radio interference may also cause problems with reception.
- Mainflingen (Germany) or Anthorn (England) transmitters: 500 kilometers (310 miles)
- Fort Collins (United States) transmitter: 600 miles (1,000 kilometers)
- Fukushima or Fukuoka/Saga (Japan) transmitters: 500 kilometers (310 miles)
- Shangqiu (China) transmitter: 500 kilometers (310 miles)
- As of July 2010, China does not use Daylight Saving Time (DST). If China does go to the Daylight Saving Time system in the future, some functions of this watch may no longer operate correctly.
- Using this watch in a country covered by a time calibration that is different from the countries it supports may result in incorrect time indication due to local application of summer time, etc.

E-16

E-17

## To get ready for a receive operation

1. Confirm that the watch is in the Timekeeping Mode. If it isn't, hold down **(D)** for about two seconds to enter the Timekeeping Mode. (page E-24)
2. The antenna of this watch is located on its 12 o'clock side. Position the watch with 12 o'clock facing towards a window as shown in the nearby illustration. Make sure there are no metal objects nearby.

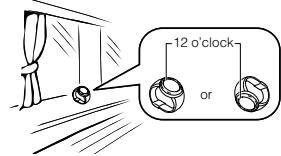

- Signal reception normally is better at night.
- The receive operation takes from two to seven minutes, but in some cases it can take as long as 14 minutes. Take care that you do not perform any button operation or move the watch during this time.

- Signal reception may be difficult or even impossible under the conditions described below.

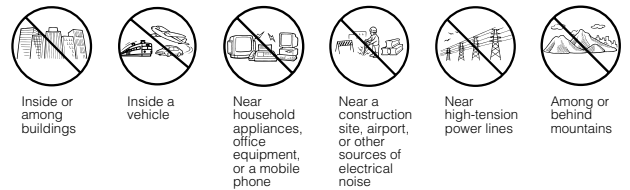

3. What you should do next depends on whether you are using Auto Receive or Manual Receive.
  - Auto Receive: Leave the watch over night in the location you selected in step 2. See "Auto Receive" below for details.
  - Manual Receive: Perform the operation under "To perform manual receive" on page E-20.

### Auto Receive

- With Auto Receive, the watch performs the receive operation each day automatically up to six times (up to five times for the Chinese calibration signal) between the hours of midnight and 5 a.m. (according to the Timekeeping Mode time). When any receive operation is successful, none of the other receive operations for that day are performed.
- When a calibration time is reached, the watch will perform the receive operation only if it is in the Timekeeping Mode or World Time Mode. The receive operation is not performed if a calibration time is reached while you are configuring settings.

E-18

E-19

- You can use the procedure under "To turn auto receive on and off" (page E-21) to enable or disable auto receive.

## To perform manual receive

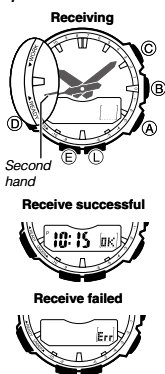

1. Use **(D)** to select the Receive Mode (RC) as shown on page E-24.
2. Hold down **(A)** until the second hand points to **READY (R)** (or **R** on some models).
  - This indicates that the watch is ready for signal reception.
  - After a short while, the second hand will move to **WORK (W)** (or **W** on some models) and signal reception will begin. Do not operate any of the watch's buttons until the second hand starts moving normally again, which indicates that reception is complete.
  - If signal reception is unstable, the second hand may keep moving between **WORK (W)** and **READY (R)**.
  - **OK** will appear on the digital display if the receive operation is successful, while **Err** indicates reception was unsuccessful.
  - If the second hand remains at **READY (R)**, press any button to cancel signal reception. Move the watch to a location where reception conditions are better and try again.
3. Press **(D)** twice to return to the Timekeeping Mode.

### Note

To cancel an ongoing signal receive operation, press any of the watch's buttons. This will return to the Receive Mode screen in step 1 of this procedure.

E-20

## To check the latest signal reception results

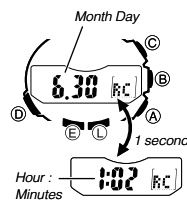

- Enter the Receive Mode (page E-24).
- When receive is successful, the digital display shows the time and date that receive was successful. - : - indicates that none of the reception operations were successful.
  - To return to the Timekeeping Mode, press **(D)** twice.

## To turn auto receive on and off

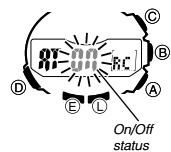

1. Enter the Receive Mode (page E-24).
2. Hold down **(E)** until **On** or **OFF** flashes on the digital display. This is the setting screen.
  - Note that the setting screen will not appear if the currently selected Home City is one that does not support time calibration reception.
3. Press **(A)** to toggle between auto receive on (**On**) and off (**OFF**).
4. Press **(E)** to exit the setting screen.

## Radio-controlled Atomic Timekeeping Precautions

- Strong electrostatic charge can result in the wrong time setting.
- Even if a receive operation is successful, certain conditions can cause the time setting to be off by up to one second.
- The watch is designed to update the date and day of the week automatically for the period January 1, 2000 to December 31, 2099. Updating of the date by signal reception will no longer be performed starting from January 1, 2100.
- If you are in an area where signal reception is not possible, the watch keeps time with the precision noted in "Specifications" (page E-103).
- The receive operation is disabled under any of the following conditions.
  - While power is at Level 3 (L) or lower (page E-11)
  - While the watch is in the power recovery mode (page E-12)
  - While a sensor operation is being performed
  - When the watch is in the function sleep state ("Power Saving", page E-14)
  - While a hand home position adjustment operation is in progress (page E-86)
  - While a countdown timer operation is in progress (page E-77)
- A receive operation is cancelled if an alarm sounds while it is being performed.
- The Home City setting reverts to the initial default of **TOKYO (TYO)** whenever the battery power level drops to Level 5 or when you have the rechargeable battery replaced. If this happens, change the Home City to the setting you want (page E-28).

## Mode Reference Guide

Your watch has 11 "modes". The mode you should select depends on what you want to do.

To do this:	Enter this mode:	See:
• View the current date in the Home City	Timekeeping Mode	E-27
• Configure Home City and daylight saving time (DST) settings		
• Configure time and date settings manually		
• Determine your current bearing or the direction from your current location to a destination as a direction indicator and angle value	Compass Mode	E-34
• Determine your current location using the watch and a map		
• View the barometric pressure and temperature at your current location	Barometer/Thermometer Mode	E-44
• View a graph of barometric pressure readings		
• View the altitude at your current location	Altimeter Mode	E-52
• Determine the altitude differential between two locations (reference point and current location)		
• Record an altitude reading with the measurement time and date		
Recall records created in the Altimeter Mode	Data Recall Mode	E-72
Use the stopwatch to measure elapsed time	Stopwatch Mode	E-75
Use the countdown timer	Countdown Timer Mode	E-77
Set an alarm time	Alarm Mode	E-79
View the current time in one of 29 cities (29 time zones) around the globe	World Time Mode	E-82
• Perform a time calibration receive operation	Receive Mode	E-20
• Check whether the last receive operation was successful		
Perform hand home position adjustment	Hand Home Position Adjustment Mode	E-86

E-22

E-23

## Selecting a Mode

- The illustration below shows which buttons you need to press to navigate between modes.
- To return to the Timekeeping Mode from any other mode, hold down (D) for about two seconds.
- In any mode, press (L) to illuminate the display.

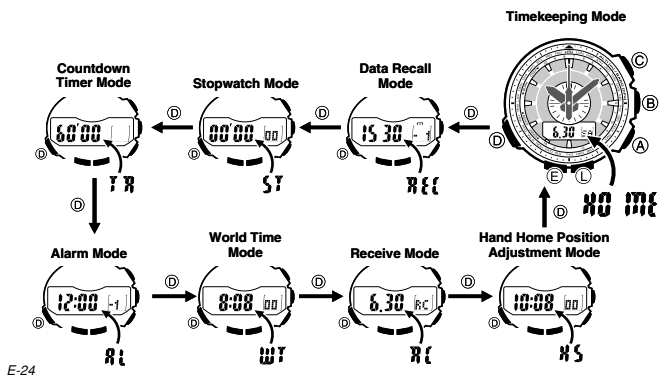

E-24

- You can use buttons (A), (B), and (C) to enter a sensor mode directly from the Timekeeping Mode or from another sensor mode. To enter a sensor mode from the Data Recall, Stopwatch, Countdown Timer, Alarm, World Time, Receive, or Hand Home Position Adjustment Mode, first enter the Timekeeping Mode and then press the applicable button.
- The hour and minute hands indicate the current time in all modes. In the Timekeeping, Data Recall, Stopwatch, Countdown Timer, and Alarm modes, the second hand indicates the current (Timekeeping Mode) second. The second hand performs other operations in the other modes.

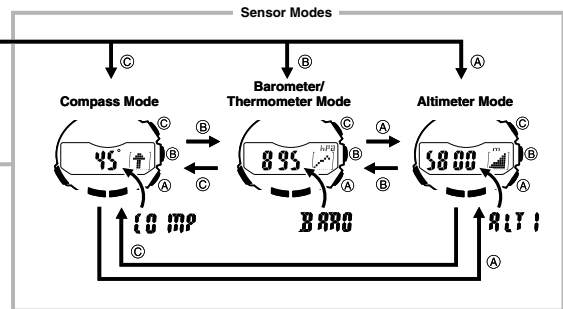

E-25

## General Functions (All Modes)

The functions and operations described in this section can be used in all of the modes.

### Auto Return Features

- The watch returns to the Timekeeping Mode automatically if you do not perform any button operation for two or three minutes in the Data Recall, Alarm, Receive, or Hand Home Position Adjustment Mode.
- If you leave a screen with flashing digits on the digital display for two or three minutes without performing any operation, the watch exits the setting screen automatically.

### Initial Screens

When you enter the Data Recall, World Time, Alarm, Compass, or Barometer/Thermometer Mode, the data you were viewing when you last exited the mode appears first.

### Scrolling

The (A) and (C) buttons are used to scroll through settings on the digital display while a setting screen is displayed, and to move the hands of the watch manually. In most cases, holding down either of these buttons will perform its operation at high speed.

E-26

## Timekeeping

Use the Timekeeping Mode (HOME) to set and view the current time and date.

- In the Timekeeping Mode, press (E) to toggle the digital display between the day of the week and the barometric pressure graph.

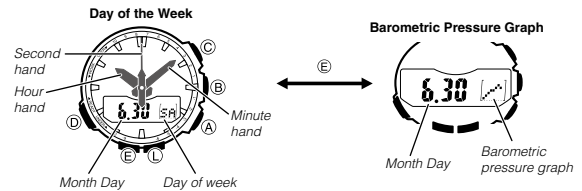

E-27

## Configuring Home City Settings

There are two Home City settings: selecting the Home City, and specifying either standard time or daylight saving time (DST).

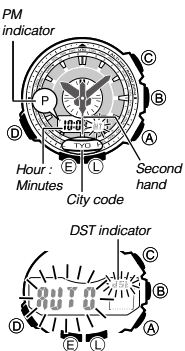

### To configure Home City settings

- In the Timekeeping Mode, hold down (E) until each of the following steps occurs.
  - Hold SET** appears on the digital display. → **HT** flashes. → Second hand points to the current Home City code.
  - For information about city codes, see the "City Code Table" at the back of this manual.
- To change the Home City code setting, press (A) to move the second hand clockwise.
  - Keep pressing (A) until the second hand is pointing to the city code you want to select as your Home City.
  - The current time in the time zone of the currently selected city code is shown on the digital display.
- Press (D). This will display the DST setting screen on the digital display.
- Use (A) to cycle through the DST settings as shown below.

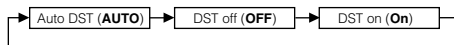

E-28

- The Auto DST (**AUTO**) setting will be available only when a city code that supports time calibration signal reception (page E-15) is selected as the Home City. While Auto DST is selected, the DST setting is changed automatically in accordance with time calibration signal data.
  - Note that you cannot switch between standard time and daylight saving time (DST) while UTC is selected as your Home City.
- After all the settings are the way you want, press (E) to return to the Timekeeping Mode.
    - The hands of the watch will move the current time in the zone where the city code you selected as your Home City is located. Do not perform any operation on the watch while the hands are moving.
    - If Daylight Saving Time is selected, the **dSt** indicator will be on the digital display.

### Note

- After you specify a city code, the watch will use UTC\* offsets in the World Time Mode to calculate the current time for other time zones based on the current time in your Home City.
  - \* Coordinated Universal Time, the world-wide scientific standard of timekeeping. The reference point for UTC is Greenwich, England.
- Selecting some city codes automatically makes it possible for the watch to receive the time calibration signal for the corresponding area. See page E-15 for details.

E-29

## To change the Daylight Saving Time (summer time) setting

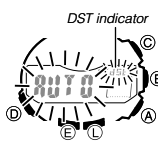

- In the Timekeeping Mode, hold down (E) until each of the following steps occurs.
  - Hold SET** appears on the digital display. → **HT** flashes. → Second hand points to the current Home City code.
- Press (D). This will display the DST setting screen on the digital display.
- Use (A) to cycle through the DST settings as shown below.



- The Auto DST (**AUTO**) setting can be selected only when a city code that supports time calibration signal reception (page E-15) is selected. While Auto DST is selected, the DST setting changes automatically in accordance with DST information included in the received time calibration signal.

- After all the settings are the way you want, press (E) to exit the setting screen.
  - The **dSt** indicator indicates that Daylight Saving Time is selected.

E-30

## Configuring Current Time and Date Settings Manually

You can configure current time and date settings manually when the watch is unable to receive a time calibration signal.

### To change the current time and date settings manually

- In the Timekeeping Mode, hold down (E) until each of the following steps occurs.
  - Hold SET** appears on the digital display. → **HT** flashes. → Second hand points to the current Home City code.
- Use (A) to select the city code you want to select as your Home City.
  - Each press of (A) moves the second hand clockwise. Keep pressing (A) until the second hand is pointed to the city code you want to select.
  - Select your Home City code before changing any other setting.
  - For full information about city codes, see the "City Code Table" at the back of this manual.

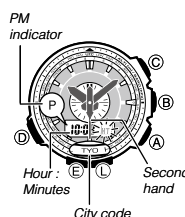

E-31

3. Press **(D)** to cycle through the available settings on the digital display in the sequence shown below.

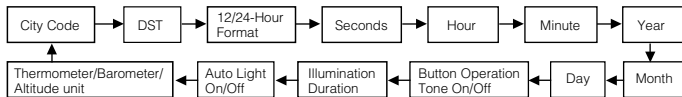

\* The following steps explain how to configure timekeeping settings only.

4. When the timekeeping setting you want to change is displayed, use **(A)** and/or **(C)** to change it as described below.

Display	To do this:	Do this:
HT	Change the city code	Press <b>(A)</b> .
AUTO #51	Cycle between Auto DST (AUTO), Daylight Saving Time (On) and Standard Time (OFF).	Press <b>(A)</b> .
12H	Toggle between 12-hour (12H) and 24-hour (24H) timekeeping.	Press <b>(A)</b> .
50	Reset the seconds to 00	Press <b>(A)</b> .
10:08	Change the hour or minute	Use <b>(A)</b> (+) and <b>(C)</b> (-).

E-32

## Taking Direction Readings

The Compass Mode uses the watch's direction sensor to detect magnetic north. The second hand will indicate magnetic north and the digital display shows one of 16 directions and an angle value.

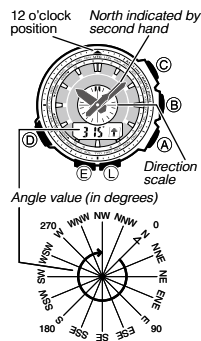

### To take a direction reading

- Check to make sure the watch is in the Timekeeping Mode or one of the sensor modes.
  - The sensor modes are the Compass Mode, Barometer/Thermometer Mode, and Altimeter Mode.
- Place the watch on a flat surface. If you are wearing the watch, make sure that your wrist is horizontal (in relation to the horizon).
- Point the 12 o'clock position of the watch in the direction you want to measure.
- Press **(C)** to start the direction reading operation, which is indicated by **COMP** appearing on the digital display.
  - When you press **(C)**, the second hand will first point in the direction of the **(C)** (COMP) button. This indicates the Compass Mode. After that the second hand will point in the direction of magnetic north.
  - For information about direction reading results, see "Interpreting Direction Reading Results" (page E-35).
- After you are finished taking direction readings, press **(D)** to return to the Timekeeping Mode.

E-34

- If the second hand is indicating 12 o'clock (north), the digital display will show an upwards pointing white on black arrow.
- The small scale in the center of the watch face is a direction scale (page E-34). You can use the direction scale to get an idea of how many degrees the 12 o'clock position of the watch is (clockwise) from the northerly indication of the second hand. The direction scale is marked in 10-degree increments. Some watch models may not have a direction scale.
- Note that taking a measurement while the watch is not horizontal (in relation to the horizon) can result in large measurement error.
- You can calibrate the bearing sensor if you suspect the direction reading is incorrect.
- Any ongoing direction measurement operation is paused temporarily while the watch is performing an alert operation (daily alarm, Hourly Time Signal, countdown timer alarm) or while illumination is turned on (by pressing **(L)**). The measurement operation resumes for its remaining duration after the operation that caused it to pause is finished.
- For precautions that should be observed when using the Compass Mode, see "Compass Precautions" (page E-43).

### Calibrating the Bearing Sensor

You should calibrate the bearing sensor whenever you feel that the direction readings being produced by the watch are off. There are three different calibration methods available: magnetic declination correction, bidirectional calibration, and northerly calibration.

#### Magnetic Declination Correction

With magnetic declination correction, you input a magnetic declination angle (difference between magnetic north and true north), which allows the watch to indicate true north. You can perform this procedure when the magnetic declination angle is indicated on the map you are using. Note that you can input the declination angle in whole degree units only, so you may need to round off the value specified on the map. If your map indicates the declination angle as 7.4°, you should input 7°. In the case of 7.6° input 8°, for 7.5° you can input 7° or 8°.

E-36

- To return the magnetic declination to its initial factory default setting, press **(A)** and **(C)** at the same time. This will cause **OFF** to appear on the digital display. After about one second, the magnetic declination will change to 0 degrees.
  - The illustration on page E-37 shows declination angle direction value and the angle value you should select when a map shows a magnetic declination of "West 1°".
3. When the setting is the way you want, press **(E)** to exit the setting screen.

#### Precautions about bidirectional calibration

- You can use any two opposing directions for bidirectional calibration. You must, however, make sure that they are 180 degrees opposite each other. Remember that if you perform the procedure incorrectly, you will get wrong bearing sensor readings.
- Do not move the watch while calibration of either direction is in progress.
- You should perform bidirectional calibration in an environment that is the same as that where you plan to be taking direction readings. If you plan to take direction readings in an open field, for example, calibrate in an open field.

#### To perform bidirectional calibration

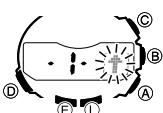

- In the Compass Mode, hold down **(E)** until each of the following steps occurs.
  - Hold SET** appears on the digital display. → Magnetic declination settings flash.
  - This is the setting screen.
- Press **(D)** to display the bidirectional calibration screen.
  - At this time, the digital display will show **-1-** to indicate that the watch is ready to calibrate the first direction.

E-38

Display	To do this:	Do this:
20 12	Change the year	Use <b>(A)</b> (+) and <b>(C)</b> (-).
6.30	Change the month or day	

5. Press **(E)** to exit the setting screen.

- The hands of the watch will move to the time you set. Do not perform any operation on the watch while the hands are moving.

#### Note

- For information about selecting a Home City and configuring the DST setting, see "Configuring Home City Settings" (page E-28).
- Changing the time on the digital display will cause the time indicated by the hands to change accordingly. If the displayed time and the time indicated by the hands do not match, it could mean that the hand home positions are off. Adjust the hand home positions as required (page E-86).
- While 12-hour format is selected, a **P** (PM) indicator will appear for times from noon to 11:59 p.m. No indicator appears for times from midnight to 11:59 a.m. With 24-hour format, time is displayed from 0:00 to 23:59, without any **P** (PM) indicator.
- The watch's built-in full automatic calendar makes allowances for different month lengths and leap years. Once you set the date, there should be no reason to change it except after you have the watch's rechargeable battery replaced or after power drops to Level 5 (page E-11).

## Interpreting Direction Reading Results

- When you press **(C)**, **COMP** appears on the digital display to indicate that direction reading has started.
- After about two seconds, the second hand moves to point to magnetic north. The digital display shows either the angle between magnetic north and the 12 o'clock position of the watch, or one of 16 literal direction indicators.
- The watch updates the direction reading about once every second for about 20 seconds, and then stops. The digital display shows **---** and the second hand moves to **COMP** (located below the **(C)** button) to indicate that direction readings are complete. If you want to continue taking direction readings, press **(C)** again.
- Pressing **(E)** at this time switches the digital display between the angle value and a one-, two-, or three-character literal direction indicators.
- The Auto Light switch is disabled during the 20 seconds that direction readings are being taken.
- The following table shows the meanings of the abbreviations used for the literal direction indicators that appear on the digital display.

Direction	Meaning	Direction	Meaning	Direction	Meaning	Direction	Meaning
N	North	NNE	North-northeast	NE	Northeast	ENE	East-northeast
E	East	ESE	East-southeast	SE	Southeast	SSE	South-southeast
S	South	SSW	South-southwest	SW	Southwest	WSW	West-southwest
W	West	WNW	West-northwest	NW	Northwest	NNW	North-northwest

- The margin of error for the angle value and the direction indicator is  $\pm 11$  degrees while the watch is horizontal (in relation to the horizon). If the indicated direction is northwest (**NW**) and 315 degrees, for example, the actual direction can be anywhere from 304 to 326 degrees.

E-35

#### Bidirectional Calibration and Northerly Calibration

Bidirectional calibration and northerly calibration calibrate the accuracy of the bearing sensor in relation to magnetic north. Use bidirectional calibration when you want to take readings within an area exposed to magnetic force. This type of calibration should be used if the watch becomes magnetized for any reason. With northerly calibration, you "teach" the watch which way is north (which you have to determine with another compass or some other means).

#### Important!

The more correctly you perform bidirectional calibration, the better the accuracy of the bearing sensor readings. You should perform bidirectional calibration whenever you change environments where you use the bearing sensor, and whenever you feel that the bearing sensor is producing incorrect readings.

#### To perform magnetic declination correction

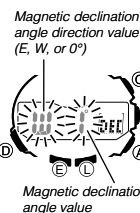

- In the Compass Mode, hold down **(E)** until each of the following steps occurs.
  - Hold SET** appears on the digital display. → Magnetic declination settings flash.
  - This is the setting screen.
- Use **(A)** (East) and **(C)** (West) to change the settings.
  - The following explains magnetic declination angle direction settings.
    - 0°:** No magnetic declination correction performed. The magnetic declination angle with this setting is 0°.
    - E:** When magnetic north is to the east (east declination)
    - W:** When magnetic north is to the west (west declination)
  - You can select a value within the range of W 90° to E 90° with these settings.

E-37

- Place the watch on a level surface facing any direction you want, and press **(C)** to calibrate the first direction.
  - is shown on the digital display while calibration is being performed. When calibration is successful, the digital display will show **-2-**. This means that the watch is ready for calibration of the second direction.
  - Calibration takes about 13 seconds. Do not move the watch while calibration is being performed.
- Rotate the watch 180 degrees.
- Press **(C)** again to calibrate the second direction.
  - is shown on the digital display while calibration is being performed. When calibration is successful, the digital display will show **OK** and then change to the Compass Mode screen (**---**).

#### To perform northerly calibration

#### Important!

If you want to perform both northerly and bidirectional calibration, perform bidirectional calibration first, and then perform northerly calibration. This is necessary because bidirectional calibration cancels any existing northerly calibration setting.



- In the Compass Mode, hold down **(E)** until each of the following steps occurs.
  - Hold SET** appears on the digital display. → Magnetic declination settings flash.
  - This is the setting screen.
- Press **(D)** twice to display the northerly calibration screen.
  - At this time, **-N-** (north) appears on the digital display.

- Place the watch on a level surface, and position it so that its 12 o'clock position points north (as measured with another compass).

E-39

- Press **(C)** to start the calibration operation.
  - is shown on the digital display while calibration is being performed. When calibration is successful, the digital display will show **OK** and then change to the Compass Mode screen (---).

### Using the Compass While Mountain Climbing or Hiking

This section provides two practical applications for using the watch's built-in compass.

- Setting a map and finding your current location
  - Having an idea of your current location is important when mountain climbing or hiking. To do this, you need to "set the map", which means to align the map so the directions indicated on it are aligned with the actual directions of your location. Basically what you are doing is aligning north on the map with north as indicated by the watch.
  - Finding the bearing to an objective

#### To set a map and find your current location

- With the watch on your wrist, position it so the face is horizontal.
- While in the Timekeeping Mode or in any of the sensor modes, press **(C)** to take a compass reading.
  - The reading result will appear on the digital display after about two seconds, and the second hand will point to north.

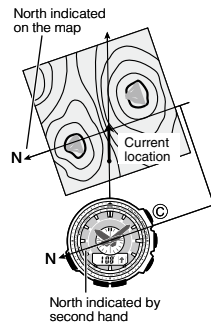

- Rotate the map without moving the watch so the northerly direction indicated on the map matches north as indicated by the watch.
  - If the watch is configured to indicate magnetic north, align the map's magnetic north with the watch indication. If the watch has been configured with a declination to correct to true north, align the map's true north with the watch indication. For details about magnetic declination correction, see "Calibrating the Bearing Sensor" (page E-36).
  - This will position the map in accordance with your current location.
- Determine your location as you check the geographic contours around you.

#### To find the bearing to an objective

- Set the map so its northerly indication is aligned with north as indicated by the watch, and determine your current location.
  - See "To set a map and find your current location" on page E-40 for information about how to perform the above step.
- Set the map so the direction you want to travel on the map is pointed straight in front of you.
- With the watch on your wrist, position it so the face is horizontal.
- While in the Timekeeping Mode or in any of the sensor modes, press **(C)** to take a compass reading.
  - The reading result will appear on the digital display after about two seconds, and the second hand will point to north.
- Still holding the map in front of you, turn your body until north as indicated by the watch and the northerly direction on the map are aligned.
  - This will position the map in accordance with your current location, so the bearing to your objective is straight ahead of you.

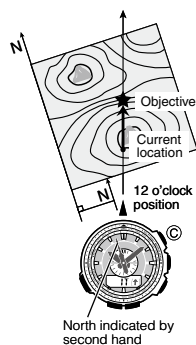

#### Compass Precautions

This watch features a built-in magnetic bearing sensor that detects terrestrial magnetism. This means that north indicated by this watch is magnetic north, which is somewhat different from true polar north. The magnetic north pole is located in northern Canada, while the magnetic South Pole is in southern Australia. Note that the difference between magnetic north and true north as measured with all magnetic compasses tends to be greater as one gets closer to either of the magnetic poles. You should also remember that some maps indicate true north (instead of magnetic north), and so you should make allowances when using such maps with this watch.

#### Location

- Taking a direction reading when you are near a source of strong magnetism can cause large errors in readings. Because of this, you should avoid taking direction readings while in the vicinity of the following types of objects: permanent magnets (magnetic necklaces, etc.), concentrations of metal (metal doors, lockers, etc.), high tension wires, aerial wires, household appliances (TVs, personal computers, washing machines, freezers, etc.).
- Accurate direction readings are impossible while in a train, boat, air plane, etc.
- Accurate readings are also impossible indoors, especially inside ferroconcrete structures. This is because the metal framework of such structures picks up magnetism from appliances, etc.

#### Storage

- The precision of the bearing sensor may deteriorate if the watch becomes magnetized. Because of this, you should store the watch away from magnets or any other sources of strong magnetism, including: permanent magnets (magnetic necklaces, etc.) and household appliances (TVs, personal computers, washing machines, freezers, etc.).
- Whenever you suspect that the watch may have become magnetized, perform the procedure under "To perform bidirectional calibration" (page E-38).

## Taking Barometric Pressure and Temperature Readings

This watch uses a pressure sensor to measure air pressure (barometric pressure) and a temperature sensor to measure temperature.

Barometric pressure differential indicated by second hand

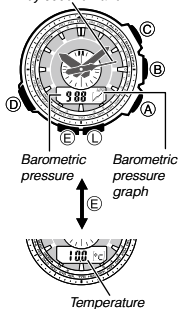

#### To enter and exit the Barometer/Thermometer Mode

- While in the Timekeeping Mode or in any of the sensor modes, press **(B)** to enter the Barometer/Thermometer Mode.
  - BARO** appears on the digital display to indicate that barometric pressure and temperature readings are being taken. The current barometric pressure or temperature appears on the digital display after readings are complete.
  - When you press **(B)**, the second hand will first point in the direction of the **(B)** (BARO) button. This indicates the Barometer/Thermometer Mode. After that, the second hand will point at the current barometric pressure differential.
  - Pressing **(E)** toggles the digital display between the barometric pressure and temperature screen.
  - After you press **(B)**, the watch takes readings every five seconds for the first three minutes, and then every two minutes after that.
- Press **(D)** to return to the Timekeeping Mode.
  - The watch will return to the Timekeeping Mode automatically if you do not perform any operation for about one hour after entering the Barometer/Thermometer Mode.

#### To take barometric pressure and temperature readings

- While in the Timekeeping Mode or in any of the sensor modes, press **(B)**.
- The watch will start taking barometric pressure and temperature readings automatically.
- You also can take a barometric pressure and temperature reading at any time by pressing **(B)** in the Barometer/Thermometer Mode.
- Press **(E)** to toggle the digital display between the barometric pressure and temperature screen.
- It can take up to four or five seconds for the barometric pressure reading to appear after you enter the Barometer/Thermometer Mode.

#### Barometric Pressure

- Barometric pressure is displayed in units of 1 hPa (or 0.05 inHg).
- The displayed barometric pressure value changes to --- if a measured barometric pressure falls outside the range of 260 hPa to 1,100 hPa (7.65 inHg to 32.45 inHg). The barometric pressure value will reappear as soon as the measured barometric pressure is within the allowable range.

#### Temperature

- Temperature is displayed in units of 0.1°C (or 0.2°F).
- The displayed temperature value changes to --- °C (or °F) if a measured temperature falls outside the range of -10.0°C to 60.0°C (14.0°F to 140.0°F). The temperature value will reappear as soon as the measured temperature is within the allowable range.

#### Display Units

You can select either hectopascals (hPa) or inchesHg (inHg) as the display unit for the measured barometric pressure, and Celsius (°C) or Fahrenheit (°F) as the display unit for the measured temperature value. See "To specify temperature, barometric pressure, and altitude units" (page E-69).

#### Note

- If there are sudden changes in weather or temperature, the graph line of past measurements may run off the top or bottom of the display. The entire graph will become visible once barometric conditions stabilize.
- The following conditions cause the barometric pressure measurement to be skipped, with the corresponding point on the barometric pressure graph being left blank.
  - Barometric reading that is out of range (260 hPa to 1,100 hPa or 7.65 inHg to 32.45 inHg)
  - Sensor malfunction



Not visible on the display.

#### Barometric Pressure Graph

Barometric pressure graph



Barometric pressure indicates changes in the atmosphere. By monitoring these changes you can predict the weather with reasonable accuracy. This watch takes barometric pressure measurements automatically every two hours (at the 30th minute of every even numbered hour). Measurement results are used as the data to create the barometric pressure graph that appears on the digital display, and the second hand indicates the barometric pressure differential.

#### Reading the Barometric Pressure Graph

The barometric pressure graph shows readings of previous measurements for up to 16 hours.

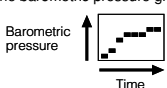

- The horizontal axis of the graph represents time, with each dot standing for two hours. The rightmost dot represents the most recent reading.
- The vertical axis of the graph represents barometric pressure, with each dot standing for the relative difference between its reading and that of the dots next to it. Each dot represents 1 hPa.

The following shows how to interpret the data that appears on the barometric pressure graph.



A rising graph generally means improving weather.



A falling graph generally means deteriorating weather.

#### About the barometric pressure differential indicated by the second hand



In the Barometer/Thermometer Mode, the second hand indicates the difference between the value of the last barometric pressure reading displayed in the barometric pressure graph (page E-46) and the value of the last barometric pressure reading taken by the watch (which is shown on the digital display).

## Barometer/Thermometer Mode Second Hand Units

The second hand indicates barometric pressure differentials up to  $\pm 10$ hPa (in 1-hPa units).

- The nearby illustration, for example, shows what the second hand would indicate when the calculated differential is approximately 5 hPa (approximately 0.15 inHg).
- The second hand will point to **OVER** or **UNDER** if the barometric pressure differential is outside the allowable range of the scale.
- The second hand will move to 9 o'clock if a sensor reading could not be taken for some reason or if the reading is outside the allowable range.
- Barometric pressure is calculated and displayed using hPa as the standard. The barometric pressure differential also can be read in inHg units as shown in the illustration (1 hPa = 0.03 inHg).

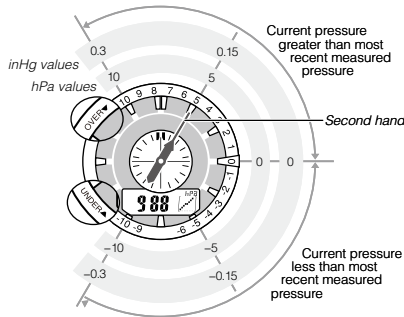

## Pressure Sensor and Temperature Sensor Calibration

The pressure sensor and temperature sensor built into the watch are calibrated at the factory and normally require no further adjustment. If you notice serious errors in the pressure readings and temperature readings produced by the watch, you can calibrate a sensor to the reading of another device to correct the errors.

### Important!

- Incorrectly calibrating the pressure sensor can result in incorrect readings. Before changing the calibration value, make sure the readings you are using are reliable and accurate.
- Incorrectly calibrating the temperature sensor can result in incorrect readings. Carefully read the following before doing anything.
  - Compare the readings produced by the watch with those of another reliable and accurate thermometer.
  - If adjustment is required, remove the watch from your wrist and wait for 20 or 30 minutes to give the temperature of the watch time to stabilize.

E-48

E-49

## To calibrate the pressure sensor and the temperature sensor

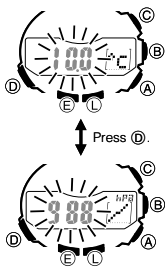

- Take a reading with another measurement device to determine the exact current barometric pressure or temperature.
- With the watch in the Timekeeping Mode or in any of the sensor modes, press (B) to enter the Barometer/Thermometer Mode.
- Hold down (E) until each of the following steps occurs.
  - Hold **SET** appears on the digital display. → The current temperature value flashes.
- Press (D) to move the flashing between the temperature value and barometric pressure value, to select the one you want to calibrate.
- Use (A) (+) and (C) (-) to adjust the calibration value in the units shown below.
 

Temperature	0.1°C (0.2°F)
Barometric Pressure	1 hPa (0.05 inHg)

  - To return the currently flashing value to its initial factory default setting, press (A) and (C) at the same time. **OFF** will appear at the flashing location for about one second, followed by the initial default value.
- Press (E) to return to the Barometer/Thermometer Mode screen.

## Barometer and Thermometer Precautions

- The pressure sensor built into this watch measures changes in air pressure, which you can then apply to your own weather predictions. It is not intended for use as a precision instrument in official weather prediction or reporting applications.
- Sudden temperature changes can affect pressure sensor readings.
- Temperature measurements are affected by your body temperature (while you are wearing the watch), direct sunlight, and moisture. To achieve a more accurate temperature measurement, remove the watch from your wrist, place it in a well ventilated location out of direct sunlight, and wipe all moisture from the case. It takes approximately 20 to 30 minutes for the case of the watch to reach the actual surrounding temperature.

E-50

E-51

## Taking Altitude Readings

The watch displays altitude values based on air pressure readings taken by a built-in pressure sensor.

### How the Altimeter Measures Altitude

The altimeter can measure altitude based on its own preset values (initial default method) or using a reference altitude specified by you.

#### When you measure altitude based on preset values

Data produced by the watch's barometric pressure sensor is converted to approximate altitude based on ISA (International Standard Atmosphere) conversion values stored in watch memory.

#### When you measure altitude using a reference altitude specified by you

After you specify a reference altitude, the watch uses that value to convert barometric pressure readings to altitude (page E-62).

- When mountain climbing, you can specify a reference altitude value in accordance with a marker along the way or altitude information from a map. After that, the altitude readings produced by the watch will be more accurate than they would without a reference altitude value.



## To take an altimeter reading

Altitude differential indicated by second hand



- Make sure the watch is in the Timekeeping Mode or any one of the sensor modes.
  - The sensor modes are: Compass Mode, Barometer/Thermometer Mode, and Altimeter Mode.
- Press (A) to start Altimeter measurement.
  - When you press (A), the second hand will first point in the direction of the (A) (ALTI) button. This indicates the Altimeter Mode. After that, the second hand will point at the current altitude differential.
  - ALTI** will appear on the digital display, indicating that Altimeter measurement is in progress. The first reading will appear on the digital display after about four or five seconds.
  - The current altitude value is displayed in units of 5 meters (20 feet).
  - After the first reading is obtained, the watch continues to take altimeter readings automatically every five seconds for the first three minutes, and then every two minutes after that (under initial default settings).
- If you leave the watch in the Altimeter Mode, it will update the displayed altitude value regularly and indicate reading-to-reading changes in graph form.
- You can use the procedure under "Selecting an Altitude Auto Measurement Method" (page E-55) to specify the altitude auto measurement method you want to use.
- After you are finished using the Altimeter, press (D) to return to the Timekeeping Mode and stop auto measurement.
  - The watch will return to the Timekeeping Mode automatically if you do not perform any operation for about 10 hours after entering the Altimeter Mode (under initial default settings).

E-52

E-53

## Reading the Altitude Graph

The altitude graph shows Altimeter Mode auto measurement readings over time.

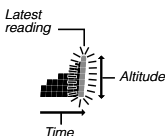

- The vertical axis of the graph represents altitude, and each dot stands for 10 meters (40 feet).
- The horizontal axis represents time. For the altitude readings taken during the first three minutes after you start an altimeter measurement operation, each dot represents five seconds. After that, each dot represents two minutes (under initial default settings).
- An out of range reading or a measurement error will cause the column of dots for that reading to be blank (skipped).

### Note

- The measurement range for altitude is -700 to 10,000 meters (-2,300 to 32,800 feet).
- The displayed altitude value changes to - - - if an altitude reading falls outside the measurement range. An altitude value will reappear as soon as the altitude reading is within the allowable range.
- Normally, displayed altitude values are based on the watch's preset conversion values. You also can specify a reference altitude value, if you want. See "Specifying a Reference Altitude Value" (page E-61).
- You can change the unit for displayed altitude values to either meters (m) or feet (ft). See "To specify temperature, barometric pressure, and altitude units" (page E-69).

## Selecting an Altitude Auto Measurement Method

You can select either of the following two altitude auto measurement methods.

**0'05 1H:** Readings at five-second intervals for one hour

**2'00 10H:** Readings at five-second intervals for the first three minutes followed by two-minute intervals for approximately 10 hours

### Note

If you do not perform any button operation while in the Altimeter Mode, the watch will return to the Timekeeping Mode automatically after 10 hours (altitude auto measurement method: **2'00 10H**) or after one hour (altitude auto measurement method: **0'05 1H**).

### To select the altitude auto measurement method

- In the Altimeter Mode, hold down (E) until each of the following steps occurs.
  - Hold **SET** appears on the digital display. → **Hold SET** disappears.
- Press (D) to display the current altitude auto measurement method setting.
  - This will cause either **0'05** or **2'00** to flash on the digital display.
- Press (A) to toggle the altitude auto measurement method setting between **0'05 1H** and **2'00 10H**.
- Press (E) to exit the setting screen.

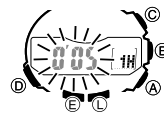

E-54

E-55

## Using the Altitude Differential Value

Altitude differential indicated by second hand



In the Altimeter Mode, the part of the watch's dial from 11 o'clock to 7 o'clock acts as an altitude differential scale. The second hand points to a place on the scale that indicates the difference between the altitude at a start point set by you and the altitude at your current location. The altitude differential indication is updated each time the watch takes an altitude reading.

You can configure the watch so each second mark in the altitude differential scale stands for 5 meters (20 feet) or 50 meters (200 feet). See "Configuring the Altitude Differential Scale" (page E-58) for information about how to configure this setting.

- The second hand will point to **OVER** or **UNDER** if the altitude differential is outside the allowable range of the scale.
- The second hand will move to 9 o'clock if a sensor reading could not be taken for some reason or if the reading is outside the allowable range.
- See "Using the Altitude Differential Value While Mountain Climbing or Hiking" (page E-60) for some real-life examples of how to use this feature.

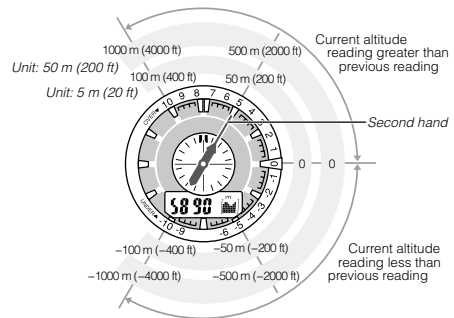

E-56

E-57

## Configuring the Altitude Differential Scale

You can select either of the two altitude differential scale options described below.

To specify this:	Select this setting:
Scale step: 5 meters (20 feet) per second mark Scale range: ±100 meters (± 400 feet)	100
Scale step: 50 meters (200 feet) per second mark Scale range: ±1000 meters (± 4000 feet)	1000

- Altitude differential is always calculated in meters, even when feet is selected as the altitude measurement unit.

## To change the altitude differential scale step unit

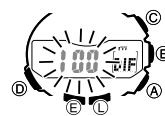

- In the Altimeter Mode, hold down **(E)** until each of the following steps occurs.
  - **Hold SET** appears on the digital display. → **Hold SET** disappears.
- Press **(D)** twice.
  - This will cause either **100** or **1000** to flash on the digital display.
- Press **(A)** to toggle the altitude differential scale step unit between **100** and **1000**.
- Press **(E)** to exit the setting screen.

## To set the altitude differential start point



Altitude differential indicated by second hand

- In the Altimeter Mode, press **(E)**.
- The watch will take an altitude reading and record the result as the current differential start point. At this time, the second hand will point to 0 because that is the current altitude differential.

E-58

E-59

## Using the Altitude Differential Value While Mountain Climbing or Hiking

After you specify the altitude differential start point while mountain climbing or hiking, you easily can measure the change in the altitude between that point and other points along the way.

### To use the altitude differential value

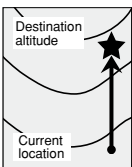

- In the Altimeter Mode, check to make sure that an altitude reading is on the digital display.
  - If an altitude reading is not displayed, press **(A)** to take one. See "To take an altimeter reading" (page E-53) for details.
- Use the contour lines on your map to determine the difference in altitude between your current location and your destination.
- In the Altimeter Mode, press **(E)** to specify your current location as the altitude differential start point.
  - The watch will take an altitude reading and register the result as the altitude differential value start point. The altitude differential value will be reset to zero at this time.

Altitude differential indicated by second hand

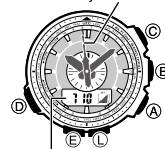

Altitude

- While comparing the altitude difference you determined on the map and the watch's altitude differential value, advance towards your destination.
  - If the map shows a difference of +80 meters between your current location and your destination, you will know that you are approaching your destination when the second hand is pointed at +80 meters.

## Specifying a Reference Altitude Value

The altitude readings produced by this watch are subject to error caused by changes in air pressure. Because of this, we recommend that you update the reference altitude value whenever one is available during your climb. After you specify a reference altitude value, the watch adjusts its air-pressure-to-altitude conversion calculation accordingly.

E-60

E-61

## To specify a reference altitude value

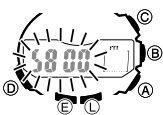

- In the Altimeter Mode, hold down **(E)** until each of the following steps occurs.
  - **Hold SET** appears on the digital display. → **Hold SET** disappears.
- Press **(A)** (+) or **(C)** (-) to change the current reference altitude value by 5 meters (or 20 feet).
  - Specify a reference altitude value based on accurate altitude information about your current location from a map, etc.
  - You can set the reference altitude value within the range of -10,000 to 10,000 meters (-32,800 to 32,800 feet).
  - Pressing **(A)** and **(C)** at the same time returns to **OFF** (no reference altitude value), so the watch performs air pressure to altitude conversions based on preset data only.
- Press **(E)** to exit the setting screen.

## Types of Altitude Data

The watch can maintain two types of altitude data in its memory: manual save records, and auto save values (low altitude, high altitude, cumulative ascent, cumulative descent).

- Use the Data Recall Mode to view data stored in memory. See "Viewing Altitude Records" (page E-72) for details.

## Manual Save Records

Any time you perform the procedure below in the Altimeter Mode, the watch will create and store a record with the currently displayed altitude reading, along with the date and time the reading was taken. There is enough memory to store up to 14 manual save records, which are numbered from **REC01** through **REC14**.

### To create a manual save record

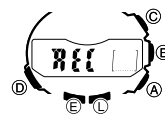

- In the Altimeter Mode, check to make sure that an altitude reading is on the digital display.
  - If an altitude reading is not displayed, press **(A)** to take one. See "To take an altimeter reading" (page E-53) for details.
- Hold down **(A)** until **Hold REC** appears on the digital display and then changes to **REC**.
  - This will save the currently displayed altitude reading in a manual save record, along with the measurement time and date.
  - The watch will return to the Altimeter Mode screen automatically after the save operation is complete.
  - There is enough memory to store up to 14 manual save records. If there are already 14 manual save records in memory, the above operation will cause the oldest record to be deleted automatically to make room for the new one.

E-62

E-63

## Auto Save Values

While the altitude auto measurement method is being used (page E-55), the watch automatically stores high altitude (HI), low altitude (LO), cumulative ascent (ASC), and cumulative descent (DSC) values.  
 \* These values are checked and updated automatically by the watch as altitude auto measurements are taken.

## How high altitude and low altitude values are updated

While the watch is in the Altimeter Mode, altitude readings are taken automatically at the interval specified by the altitude auto measurement method (page E-55). With each reading, the watch compares the current reading against the HI and LO values. It will replace the HI value if the current reading is greater than HI, or the LO value if the current reading is less than LO.

## How Cumulative Ascent/Descent Values Are Updated

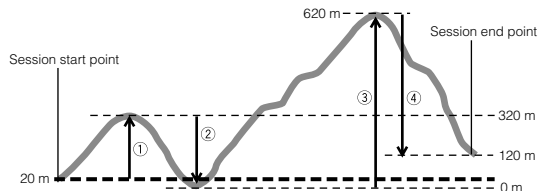

E-64

The total Cumulative Ascent and Cumulative Descent values produced by an Altimeter Mode measurement session during the example climb illustrated above are calculated as follows.

Cumulative Ascent: ① (300 m) + ③ (620 m) = 920 m  
 Cumulative Descent: ② (320 m) + ④ (500 m) = 820 m

- Entering the Altimeter Mode starts a new altitude auto measurement session, but it does not reset the current ASC and DSC values or change them in any way. This means that the starting ASC and DSC values for a new Altimeter Mode auto measurement session are the values that currently are in memory. Each time you complete an Altimeter Mode auto measurement session by returning to the Timekeeping Mode, the cumulative ascent value of the current session (920 meters in the above example) is added to the session's starting ASC value. Also, the cumulative descent value of the current auto measurement session (-820 meters in the above example) is added to the session's starting DSC value.
- Note that any change in elevation when ascending that is less than 15 meters (49 feet) is not added to the cumulative ascent value for the current Altimeter Mode auto measurement session. Also, any change in elevation when descending that is less than -15 meters (-49 feet) is not added to the cumulative descent value for the current Altimeter Mode auto measurement session.

## Note

- The high altitude, low altitude, cumulative ascent, and cumulative descent values are retained in memory when you exit the Altimeter Mode. To clear values, perform the procedure under "To delete a single altitude record" (page E-74) or "To delete all altitude records" (page E-74).

E-65

## How does the altimeter work?

Generally, air pressure and temperature decrease as altitude increases. This watch bases its altitude measurements on International Standard Atmosphere (ISA) values stipulated by the International Civil Aviation Organization (ICAO). These values define relationships between altitude, air pressure, and temperature.

Altitude	Air Pressure	Temperature
4000 m	616 hPa	-11°C
3500 m	701 hPa	-4.5°C
3000 m		
2500 m	795 hPa	2°C
2000 m		
1500 m	899 hPa	8.5°C
1000 m		
500 m	1013 hPa	15°C
0 m		

Source: International Civil Aviation Organization

- Note that the following conditions will prevent you from obtaining accurate readings:

*When air pressure fluctuates because of changes in the weather*

*Extreme temperature changes*

*When the watch itself is subjected to strong impact*

There are two standard methods of expressing altitude: Absolute altitude and relative altitude. Absolute altitude expresses an absolute height above sea level. Relative altitude expresses the difference between the height of two different places.

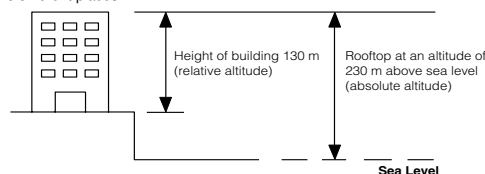

E-66

E-67

## Altimeter Precautions

- This watch estimates altitude based on air pressure. This means that altitude readings for the same location may vary if air pressure changes.
- The semiconductor pressure sensor used by the watch for altitude measurements is also affected by temperature. When taking altitude measurements, do not subject the watch to temperature changes.
- Do not rely upon this watch for altitude measurements or perform button operations while sky diving, hang gliding, or paragliding, while riding a gyrocopter, glider, or any other aircraft, or while engaging in any other activity where there is the chance of sudden altitude changes.
- Do not use this watch for measuring altitude in applications that demand professional or industrial level precision.
- Remember that the air inside of a commercial aircraft is pressurized. Because of this, the readings produced by this watch will not match the altitude readings announced or indicated the flight crew.

## Specifying Temperature, Barometric Pressure, and Altitude Units

Use the procedure below to specify the temperature, barometric pressure, and altitude units to be used in the Barometer/Thermometer Mode and the Altimeter Mode.

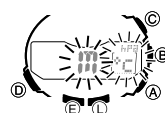

### Important!

When TOKYO (TYO) is selected as the Home City, the altitude unit is set automatically to meters (m), the barometric pressure unit to hectopascals (hPa), and the temperature unit to Celsius (°C). These settings cannot be changed.

### To specify temperature, barometric pressure, and altitude units

- In the Timekeeping Mode, hold down (E) until each of the following steps occurs.
  - Hold SET appears on the digital display. → HT flashes. → Second hand points to the current Home City code.
- Use (D) to cycle through the settings on the digital display until the unit setting screen is shown.
  - See step 3 under "To change the current time and date settings manually" (page E-31) for information about how to scroll through setting screens.

E-68

E-69

3. Perform the operations below to specify the units you want.

To specify this unit:	Press this key:	To toggle between these settings:
Altitude	(A)	m (meters) and ft (feet)
Barometric Pressure	(B)	hPa (hectopascals) and inHg (inches of mercury)
Temperature	(C)	°C (Celsius) and °F (Fahrenheit)

4. After the settings are the way you want, press (E) to exit the setting screen.

## Precautions Concerning Simultaneous Measurement of Altitude and Temperature

Though you can perform altitude and temperature measurements at the same time, you should remember that each of these measurements requires different conditions for best results. With temperature measurement, it is best to remove the watch from your wrist in order to eliminate the effects of body heat. In the case of altitude measurement, on the other hand, it is better to leave the watch on your wrist, because doing so keeps the watch at a constant temperature, which contributes to more accurate altitude measurements.

- To give altitude measurement priority, leave the watch on your wrist or in any other location where the temperature of the watch is kept constant.
- To give temperature measurement priority, remove the watch from your wrist and allow it to hang freely from your bag or in another location where it is not exposed to direct sunlight. Note that removing the watch from your wrist can affect pressure sensor readings momentarily.

E-70

E-71

## Viewing Altitude Records

Use the Data Recall Mode to view manual save altitude records and automatically saved high altitude, low altitude, cumulative ascent, and cumulative descent values. Altitude records are created and saved in the Altimeter Mode.



### To view altitude records

- Use **(D)** to select the Data Recall Mode (REC) as shown on page E-24.
- Use **(A)** and **(C)** to scroll through altitude records in the sequence shown on page E-73.
  - For a manual save record, high altitude and low altitude records, the month and day of the reading will appear first. After about one second, this will change to show the time of the reading. After that the time and altitude reading will alternate on the digital display at one-second intervals. For cumulative ascent and cumulative descent, the digital display will show the month and day of the first reading. After about one second, this will change to show the cumulative altitude.

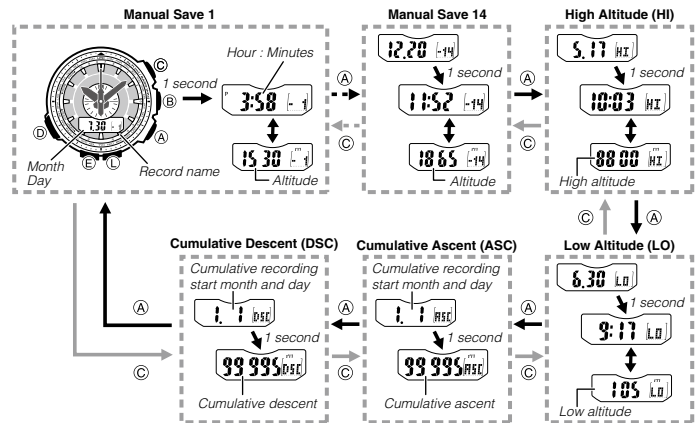

E-72

E-73

- After you are finished viewing data, use **(D)** to exit the Data Recall Mode.

- -- will be displayed if data has been deleted or if there is no corresponding data due to error, etc. In such cases, cumulative ascent (ASC) and cumulative descent (DSC) values will show zero.
- When the cumulative ascent (ASC) or cumulative descent (DSC) exceeds 99,995 meters (or 327,980 feet), the applicable value will restart from zero.

### To delete a single altitude record

- In the Data Recall Mode, use **(A)** and **(C)** to scroll through records until the one you want to delete is displayed.
- Hold down **(E)** for about two seconds until each of the following steps occurs.
  - Hold CLR appears on the digital display. → CLR appears.
  - This deletes the record you displayed in step 1.
  - Release **(E)** after CLR appears on the digital display.
  - Deleting a manual save record shifts all of the records following it up one position.

### To delete all altitude records

- In the Data Recall Mode, hold down **(E)** for about five seconds until each of the following steps occurs.
- Hold CLR appears on the digital display. → CLR appears. → Hold ALL appears. → CLR ALL appears.
  - This deletes all of the records currently in memory.

E-74

E-75

### To measure two finishes



### Note

- The Stopwatch Mode can indicate elapsed time up to 59 minutes, 59.99 seconds.
- Once started, stopwatch timing continues until you press **(C)** to stop it, even if you exit the Stopwatch Mode to another mode and even if timing reaches the stopwatch limit defined above.
- Exiting the Stopwatch Mode while a split time is frozen on the digital display clears the split time and returns to elapsed time measurement.

E-76

E-77

### To perform a countdown timer operation



- Before starting a countdown timer operation, check to make sure that a countdown operation is not in progress (indicated by the seconds counting down). If it is, press **(A)** to stop it and then **(C)** to reset to the countdown start time.
- An alarm sounds for five seconds when the end of the countdown is reached. This alarm will sound in all modes. The countdown time is reset to its starting value automatically when the alarm sounds.

### To stop the alarm

Press any button.

E-78

E-79

## Using the Stopwatch

The stopwatch measures elapsed time, split times, and two finishes.

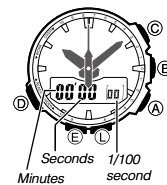

### To enter the Stopwatch Mode

- Use **(D)** to select the Stopwatch Mode (ST) as shown on page E-24.
- About one second after ST appears on the digital display, the display will change to show the stopwatch time.

### To perform an elapsed time operation



### To pause at a split time



## Using the Countdown Timer

The countdown timer can be configured to start at a preset time, and sound an alarm when the end of the countdown is reached.



### To enter the Countdown Timer Mode

- Use **(D)** to select the Countdown Timer Mode (TR) as shown on page E-24.
- About one second after TR appears on the digital display, the display will change to show the current countdown start time.

### To specify the countdown start time

- Enter the Countdown Timer Mode.
  - If a countdown is in progress (indicated by the seconds counting down), press **(A)** to stop it and then press **(C)** to reset to the current countdown start time.
  - If a countdown is paused, press **(C)** to reset to the current countdown start time.
- Hold down **(E)** until each of the following steps occurs.
  - Hold SET appears on the digital display. → The current countdown start time flashes.
- Use **(A)** (+) and **(C)** (-) to change the minute setting.
- Press **(E)** to exit the setting screen.

## Using the Alarm

You can set five independent daily alarms. When a daily alarm is turned on, an alarm tone will sound for about 10 seconds each day when the time in the Timekeeping Mode reaches the preset alarm time. This is true even if the watch is not in the Timekeeping Mode. You can also turn on an Hourly Time Signal, which will cause the watch to beep twice every hour on the hour.

### To enter the Alarm Mode

- Use **(D)** to select the Alarm Mode (AL) as shown on page E-24.
- About one second after AL appears on the digital display, the display will change to show an alarm number (-1 through -5) or the alarm indicator. The alarm number indicates an alarm screen. is shown when the Hourly Time Signal screen is on the digital display.
  - When you enter the Alarm Mode, the data you were viewing when you last exited the mode appears first.

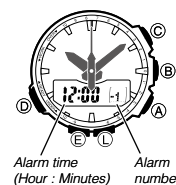

## To set an alarm time

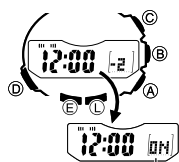

1. In the Alarm Mode, use (A) and (C) to scroll through the alarm (-1 through -5) until the one whose time you want to set is displayed.

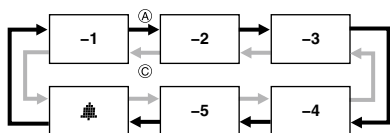

2. Hold down (E) until each of the following steps occurs.  
 • **Hold SET** appears on the digital display. → The current setting flashes.  
 • This is the setting screen.

3. Press (D) to move the flashing between the hour and minute settings.

4. While a setting is flashing, use (A) (+) and (C) (-) to change it.

• When setting the alarm time using the 12-hour format, take care to set the time correctly as a.m. (no indicator) or p.m. (P indicator).

5. Press (E) to exit the setting screen.

E-80

## To test the alarm

In the Alarm Mode, hold down (A) to sound the alarm tone.

## To turn an alarm and the Hourly Time Signal on and off

1. In the Alarm Mode, use (A) and (C) to select an alarm or the Hourly Time Signal.

2. When the alarm or the Hourly Time Signal you want is selected, press (B) to toggle it between (ON) and off (OFF).

• The alarm on indicator (when any alarm is on) and the hourly time signal on indicator (when the hourly time signal is on) are shown on the digital display in all modes.

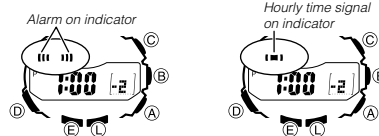

## To stop the alarm

Press any button.

E-81

## Checking the Current Time in a Different Time Zone

You can use the World Time Mode to view the current time in one of 29 time zones (29 cities) around the globe. The city that is currently selected in the World Time Mode is called the "World Time City".

• You also can swap the current World Time City and Home Time City in the World Time Mode. (page E-84)

Currently selected World Time City



Current time in the currently selected World Time City

## To enter the World Time Mode

Use (D) to select the World Time Mode (WT) as shown on page E-24.

• **WT** appears on the digital display and the second hand moves to the city code of the currently selected World Time City.

## To view the time in another time zone

In the World Time Mode, use (A) to move the second hand to a city code in the zone whose time you want to view.

• Keep pressing (A) until the second hand is pointing to the city code you want.  
 • The current time in time zone of the currently selected city code is shown in the digital display.

## To specify standard time or daylight saving time (DST) for a city

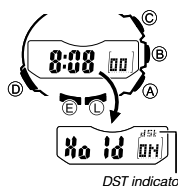

1. In the World Time Mode, use (A) to move the second hand to the city code whose standard time/daylight saving time setting you want to change.

• Keep pressing (A) until the second hand is pointing to the city code you want.

2. Hold down (E) until each of the following steps occurs.

• **Hold** appears on the digital display. → **Hold** disappears.

• This toggles the city code you selected in step 1 between Daylight Saving Time (**dSt** indicator displayed) and standard time (**dSt** indicator not displayed).

• Using the World Time Mode to change the DST setting of the city code that is selected as your Home City also will change the Timekeeping Mode time DST setting.

• Note that you cannot switch between standard time/daylight saving time (DST) while UTC is selected as the World Time City.

• The standard time/daylight saving time (DST) setting affects only the currently selected time zone. Other time zones are not affected.

E-82

E-83

## Swapping the Home City and World Time City

You can use the procedure below to swap your Home City with your World Time City.

This function comes in handy for those who often travel between two different time zones.

The following example shows what happens when the Home City and World Time City are swapped while the Home City originally is **TOKYO (TYO)** and the World Time City is **NEW YORK (NYC)**.

	Home City	World Time City
Before swapping	Tokyo 10:08 p.m. (Standard time)	New York 9:08 a.m. (Daylight saving time)
After swapping	New York 9:08 a.m. (Daylight saving time)	Tokyo 10:08 p.m. (Standard time)

## To swap your Home City and World Time City

1. In the World Time Mode, use (A) to select the city code you want to make your World Time City.

• Keep pressing (A) until the second hand is pointing to the city code you want.

• In this example, you would move the second hand to **NEW YORK (NYC)** in order to select New York as the World Time City.

2. Hold down (C) until each of the following steps occurs.

• **Hold** (H) appears on the digital display. → **Hold** (H) disappears.

• This will cause the World Time City (**NEW YORK/NYC** in this example) you selected in step 1 of this procedure your new Home City, and your previously selected Home City (**TOKYO/TYO** in this example) will become your new World Time City. The digital display and hands will indicate the current time in your new World Time City (**TOKYO/TYO** in this example).

E-84

E-85

## Auto Correction of Hand Home Positions

Strong magnetism or impact can cause the hands of the watch to be off, even if the watch is able to perform the signal receive operation. This watch performs an auto correction procedure to ensure that the hands are always in the correct positions.

• Auto correction is performed only while the watch is in the Timekeeping Mode. Auto correction is not performed if the watch is in the Timekeeping Mode while a Countdown Timer Mode operation is in progress.

• Each hour, the watch performs automatic correction of the hand positions from -55 minutes to +5 minutes.

• You also can trigger auto correction of hand home positions manually, if you want. See "To trigger auto correction of hand home positions" (page E-87) for more information.

• Auto correction of hand home positions can take up to three and a half minutes to complete.

• If hand positions are off by one hour or more, correct them using the procedure under "To trigger auto correction of hand home positions" (page E-87) or "Adjusting Home Positions Manually" (page E-88).

## To trigger auto correction of hand home positions

• Perform the following procedure when the time setting is off.

1. Use (D) to enter the Hand Home Position Adjustment Mode (page E-24).

• The digital display will show the current Timekeeping Mode time. You can check the hand positions by comparing the digital time with the time indicated by the analog hands.

2. Hold down (A) for about three seconds until each of the following steps occurs.

• **Hold HS** appears on the digital display. → **H-S** flashes.

• This starts auto hand home position adjustment.

• To cancel an ongoing auto hand home position operation part way through, press (A).



E-86

E-87

## Adjusting Home Positions Manually

Strong magnetism or impact can cause the hands of the watch to be off, even if the watch is able to perform the signal receive operation. When this happens, you can manually adjust the hand home positions to ensure correct timekeeping.

- Hand home position adjustment is not necessary as long as the hands are indicating time correctly.

### To adjust home positions manually

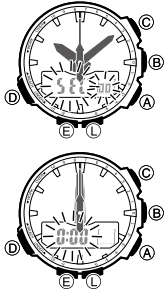

1. Enter the Hand Home Position Adjustment Mode (page E-24).
  - The digital display will show **HS**, followed by the current Timekeeping Mode time. You can use the digital display to check if the hand positions are correct and to confirm whether the analog time indication matches the digital time.
2. Hold down (E) until each of the following steps occurs.
  - **Hold SET** appears on the digital display. → **SEC 00** flashes.
  - The second hand should move to 12 o'clock at this time. If it doesn't, use (A) (+) to move the second hand so it aligns with 12 o'clock.
3. After the second hand is aligned correctly, press (D).
  - The hour and minute hands should move to 12 o'clock. If they don't, use (A) (+) and (C) (-) to move them so they align with 12 o'clock.
  - Pressing (D) here returns to the second hand home position adjustment in step 2.

E-88

E-89

## Illumination



The face of the watch is illuminated for easy reading in the dark. The watch's auto light switch turns on illumination automatically when you angle the watch towards your face.

- The auto light switch must be turned on (page E-93) for it to operate.

### To turn on illumination manually

- Press (L) in any mode to turn on illumination.
- You can use the procedure below to select either one second or three seconds as the illumination duration. When you press (L), illumination will remain on for about one second or three seconds, depending on the current illumination duration setting.
  - The above operation turns on illumination regardless of the current auto light switch setting.
  - Illumination cannot be used during time calibration signal reception, in a sensor mode, while a compass operation is in progress, or while hand home position adjustment is being performed.

E-90

E-91

### Warning!

- Always make sure you are in a safe place whenever you are reading the display of the watch using the auto light switch. Be especially careful when running or engaged in any other activity that can result in accident or injury. Also take care that sudden illumination by the auto light switch does not startle or distract others around you.
- When you are wearing the watch, make sure that its auto light switch is turned off before riding on a bicycle or operating a motorcycle or any other motor vehicle. Sudden, unintended operation of the auto light switch can create a distraction, which can result in a traffic accident and serious personal injury.

### Note

- This watch features a "Full Auto LED Light", so the auto light switch operates only when available light is below a certain level. Illumination does not turn on under bright light.
- The auto light switch is always disabled, regardless of its on/off setting, when any one of the following conditions exists.
  - While an alarm is sounding
  - During sensor measurement
  - While a bearing sensor calibration operation is being performed in the Compass Mode
  - While a receive operation is in progress in the Receive Mode
  - While a hand home position adjustment operation is in progress

E-92

E-93

### Auto light switch precautions

- Wearing the watch on the inside of your wrist, movement of your arm, or vibration of your arm can cause frequent activation of the auto light switch and illumination. To avoid running down the battery, turn off the auto light switch whenever engaging in activities that might cause frequent illumination.
- Note that wearing the watch under your sleeve while the auto light switch is turned on can cause frequent illumination and can run down the battery.



- Illumination may not turn on if the face of the watch is more than 15 degrees above or below parallel. Make sure that the back of your hand is parallel to the ground.
- Illumination turns off after the preset illumination duration (page E-91), even if you keep the watch pointed towards your face.
- Static electricity or magnetic force can interfere with proper operation of the auto light switch. If illumination does not turn on, try moving the watch back to the starting position (parallel with the ground) and then tilt it back towards your face again. If this does not work, drop your arm all the way down so it hangs at your side, and then bring it back up again.
- You may notice a very faint clicking sound coming from the watch when it is shaken back and forth. This sound is caused by mechanical operation of the auto light switch, and does not indicate a problem with the watch.

E-94

E-95

4. After adjusting the hour hand and minute hand home positions, press (E).

- After adjusting the home positions of the hands, leave the watch in a location where time calibration signal reception is good and perform manual receive. Next, check to make sure that the hands are indicating the time correctly. See "To perform manual receive" (page E-20) for more information.

### To change the illumination duration

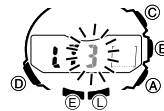

1. In the Timekeeping Mode, hold down (E) until each of the following steps occurs.
  - **Hold SET** appears on the digital display. → **HT** flashes. → Second hand points to the current Home City code.
2. Use (D) to cycle through the settings on the digital display until the current illumination duration (**LT1** or **LT3**) is shown.
  - See step 3 under "To change the current time and date settings manually" (page E-31) for information about how to scroll through setting screens.
3. Press (A) to toggle the illumination duration between three seconds (**LT3** displayed) and one second (**LT1** displayed).
4. After all the settings are the way you want, press (E) to exit the setting screen.

### About the Auto Light Switch

Turning on the auto light switch causes illumination to turn on, whenever you position your wrist as described below in any mode.

**Moving the watch to a position that is parallel to the ground and then tilting it towards you more than 40 degrees causes illumination to turn on.**

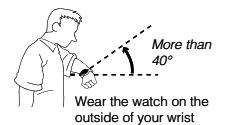

### To turn the auto light switch on and off

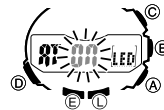

1. In the Timekeeping Mode, hold down (E) until each of the following steps occurs.
  - **Hold SET** appears on the digital display. → **HT** flashes. → Second hand points to the current Home City code.
2. Use (D) to cycle through the settings on the digital display until the current auto light switch setting (**AT OFF** or **AT ON**) is flashing on the digital display.
  - See step 3 under "To change the current time and date settings manually" (page E-31) for information about how to scroll through setting screens.
3. Press (A) to toggle the auto light switch setting between on (**On**) or off (**OFF**).
4. After the setting is the way you want, press (E) to exit the setting screen.

### Illumination Precautions

- Frequent use of illumination can run down the battery, which will require exposing the watch to light for charging. The following guidelines give an idea of the charging time required to recover from a single illumination operation.
  - Approximately five minutes exposure to bright sunlight coming in through a window
  - Approximately 50 minutes exposure to indoor fluorescent lighting
- Illumination may be hard to see when viewed under direct sunlight.
- Illumination turns off automatically whenever an alarm sounds.
- Frequent use of illumination runs down the battery.

## Button Operation Tone

The button operation tone sounds any time you press one of the watch's buttons. You can turn the button operation tone on or off as desired.

- Even if you turn off the button operation tone, the alarm, Hourly Time Signal, and Countdown Timer Mode alarm all operate normally.

### To turn the button operation tone on and off

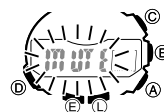

1. In the Timekeeping Mode, hold down (E) until each of the following steps occurs.
  - **Hold SET** appears on the digital display. → **HT** flashes. → Second hand points to the current Home City code.
2. Use (D) to cycle through settings on the digital display until the current button operation tone (**MUTE** or **BEEP**) is displayed.
  - See step 3 under "To change the current time and date settings manually" (page E-31) for information about how to scroll through setting screens.
3. Press (A) to toggle the button operation tone between on (**BEEP**) or off (**MUTE**).
4. After the setting is the way you want, press (E) to exit the setting screen.

## Troubleshooting

### Time Setting

See "Radio Controlled Atomic Timekeeping" (page E-15) for information about adjusting the time setting according to a time calibration signal.

#### ■ The current time setting is off by hours.

Your Home City setting may be wrong (page E-28). Check your Home City setting and correct it, if necessary.

#### ■ The current time setting is off by one hour.

If you are using the watch in an area where time calibration signal reception is possible, see "To configure Home City settings" (page E-28).

If you are using in the watch in an area where time calibration signal reception is not possible, you may need to change your Home City's standard time/daylight saving time (DST) setting manually. Use the procedure under "To change the current time and date settings manually" (page E-31) to change the standard time/daylight saving time (DST) setting.

### Hand Home Position Adjustment

#### ■ There is more than one hour difference between the time indicated by the hands and the time on the digital display.

In the Timekeeping Mode, the watch performs automatic correction of the hand position error from -55 minutes to +5 minutes, once each hour.

If the displayed time and the time indicated by the hands do not match, it could mean that the hand home positions are off. Use the Hand Home Position Adjustment Mode (page E-86) to adjust them.

E-96

\* If **Err** keeps appearing during measurement, it could mean there is a problem with the applicable sensor.

#### ■ "Err" appears on the digital display after I perform bidirectional calibration or northerly calibration.

If --- appears and then changes to **Err** (error) on the calibration screen, it means that there is something wrong with the sensor.

\* If **Err** disappears after about one second, try performing the calibration again.

\* If **Err** keeps appearing, contact your original dealer or nearest authorized CASIO distributor to have the watch checked.

#### ■ "Err" appears on the digital display after I perform northerly calibration.

The **Err** message indicates there may be some problem with the sensor. The **Err** message also may be due to movement of the watch while the calibration procedure is being performed. Try performing calibration again, taking care to ensure that the watch is not moved. If this does not solve the problem, the problem may be due to some nearby source of terrestrial magnetism. Try performing the calibration procedure again from the beginning.

Whenever you have a sensor malfunction, take the watch to your original dealer or nearest authorized CASIO distributor as soon as possible.

#### ■ What causes incorrect direction readings?

\* Incorrect bidirectional calibration. Perform bidirectional calibration (page E-38).  
 \* Nearby source of strong magnetism, such as a household appliance, a large steel bridge, a steel beam, overhead wires, etc., or an attempt to perform direction measurement on a train, boat, etc. Move away from large metal objects and try again. Note that compass operation cannot be performed inside a train, boat, etc.

E-98

### Time Calibration Signal

The information in this section applies only when **LONDON (LON)**, **PARIS (PAR)**, **ATHENS (ATH)**, **HONG KONG (HKG)**, **TOKYO (TYO)**, **HONOLULU (HNL)**, **ANCHORAGE (ANC)**, **LOS ANGELES (LAX)**, **DENVER (DEN)**, **CHICAGO (CHI)**, or **NEW YORK (NYC)** is selected at the Home City. You need to adjust the current time manually when any other city is selected as the Home City.

#### ■ The digital display shows the Err indicator when I check the result of the latest reception operation.

Possible Cause	Remedy	Page
* You are wearing or moving the watch, or performing a button operation during the signal receive operation. * The watch is in an area with poor reception conditions.	Keep the watch in an area where reception conditions are good while the signal receive operation is performed.	E-18
You are in an area where signal reception is not possible for some reason.	See "Approximate Reception Ranges".	E-16
The calibration signal is not being transmitted for some reason.	* Check the website of the organization that maintains the time calibration signal in your area for information about its down times. * Try again later.	-

E-100

#### ■ Signal reception is being performed successfully, but the time and/or day is wrong.

Possible Cause	Remedy	Page
Your Home City setting is wrong.	Check your Home City setting and correct it, if necessary.	E-28
The DST setting may be incorrect.	Change the DST setting to Auto DST.	E-28
Hand home positions are off.	Adjust the home positions of the hands.	E-86

E-102

### Sensor modes

#### ■ I can't change the temperature, barometric pressure, and altitude units.

When **TOKYO (TYO)** is selected as the Home City, the altitude unit is set automatically to meters (m), the barometric pressure unit to hectopascals (hPa), and the temperature unit to Celsius (°C). These settings cannot be changed.

#### ■ "Err" appears on the digital display while I am using a sensor.

Subjecting the watch to strong impact can cause sensor malfunction or improper contact of internal circuitry. When this happens, **Err** (error) will appear on the digital display and sensor operations will be disabled.

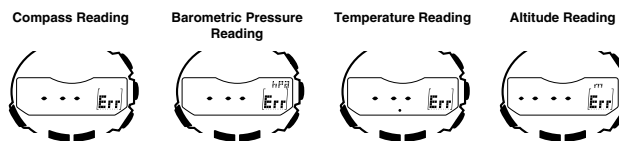

- \* If **Err** appears while a measurement operation is being performed in a sensor mode, restart the measurement. If **Err** appears on the digital display again, it can mean there is something wrong with the sensor.
- \* Even if battery power is at Level 1 (**H**) or Level 2 (**M**), the Compass Mode, Barometer/Thermometer Mode, or Altimeter Mode sensor may be disabled if there is not enough voltage available to power it sufficiently. In this case, **Err** will appear on the digital display. This does not indicate malfunction, and sensor operation should resume once battery voltage returns to its normal level.

E-97

#### ■ What causes different direction readings to produce different results at the same location?

Magnetism generated by nearby high-tension wires is interfering with detection of terrestrial magnetism. Move away from the high-tension wires and try again.

#### ■ Why am I having problems taking direction readings indoors?

A TV, personal computer, speakers, or some other object is interfering with terrestrial magnetism readings. Move away from the object causing the interference or take the direction reading outdoors. Indoor direction readings are particularly difficult inside ferro-concrete structures. Remember that you will not be able to take direction readings inside of trains, airplanes, etc.

#### ■ Why doesn't the second hand indicate the barometric pressure differential when I enter the Barometer/Thermometer Mode?

- \* This could indicate sensor error. Try pressing **Ⓢ** again.
- \* The barometric pressure differential is not indicated by the second hand if the pressure reading is outside the allowable measurement range (260 to 1,100 hPa).

### World Time Mode

#### ■ The time for my World Time City is off in the World Time Mode.

This could be due to incorrect switching between standard time and daylight saving time. See "To specify standard time or daylight saving time (DST) for a city" (page E-83) for more information.

### Charging

#### ■ The watch does not resume operation after I expose it to light.

This can happen after the power level drops to Level 5 (page E-11). Continue exposing the watch to light until the battery power indicator shows "**H**" or "**M**".

E-99

#### ■ The current time setting changes after I set it manually.

You may have the watch configured for Auto Receive of the time calibration signal (page E-19), which will cause the time to be adjusted automatically according to your currently selected Home City. If this results in the wrong time setting, check your Home City setting and correct it, if necessary (page E-28).

#### ■ The current time setting is off by one hour.

Possible Cause	Remedy	Page
Signal reception on a day for switching between standard time/daylight saving time (DST) may have failed for some reason.	Perform the operation under "To get ready for a receive operation". The time setting will be adjusted automatically as soon as signal reception is successful. If you are unable to receive the time calibration signal, change the standard time/daylight saving time (DST) setting manually.	E-18 E-31

#### ■ Auto Receive is not performed.

Possible Cause	Remedy	Page
The watch is not in the Timekeeping Mode or World Time Mode.	Auto receive is performed only while the watch is in the Timekeeping Mode or World Time Mode. Switch to either of these two modes.	E-24
Your Home City setting is wrong.	Check your Home City setting and correct it, if necessary.	E-28
There is not enough power for signal reception.	Expose the watch to light to charge it.	E-9

E-101

## Specifications

**Accuracy at normal temperature:** ±15 seconds a month (with no signal calibration)

**Digital Timekeeping:** Month, day, day of the week

Calendar: Full auto calendar from 2000 to 2099.

Other: Two display formats (day of the week and barometric pressure graph)

**Analog Timekeeping:** Hour, minute (moves every 10 seconds), second

Other: Home City code (can be assigned one of 29 city codes and Coordinated Universal Time); Standard Time/Daylight Saving Time (summer time)

**Time Calibration Signal Reception:** Auto receive 6 times a day (5 times a day for the Chinese calibration signal); Remaining auto receives cancelled as soon as one is successful; Manual receive; Receive Mode

Receivable Time Calibration Signals: Mainflingen, Germany (Call Sign: DCF77, Frequency: 77.5 kHz); Anthorn, England (Call Sign: MSF, Frequency: 60.0 kHz); Fort Collins, Colorado, the United States (Call Sign: WWVB, Frequency: 60.0 kHz); Fukushima, Japan (Call Sign: JJY, Frequency: 40.0 kHz); Fukuoka/Saga, Japan (Call Sign: JJY, Frequency: 60.0 kHz); Shangqiu City, Henan Province, China (Call Sign: BPC, Frequency: 68.5 kHz)

**Compass:** 20 seconds continuous measurement; 16 directions; Angle value 0° to 359°; Hand indication of north; Calibration (bidirectional, northerly); Magnetic declination correction

**Barometer:**  
 Measurement and display range: 260 to 1,100 hPa (or 7.65 to 32.45 inHg)  
 Display unit: 1 hPa (or 0.05 inHg)  
 Measurement timing: Daily from midnight, at two hour intervals (12 times per day); Every five seconds in the Barometer/Thermometer Mode  
 Other: Calibration; Manual measurement (button operation); Barometric pressure graph; Hand indication of pressure differential

E-103

# Operation Guide 5114 5214

CASIO®

## Thermometer:

Measurement and display range: -10.0 to 60.0°C (or 14.0 to 140.0°F)  
 Display unit: 0.1°C (or 0.2°F)  
 Measurement timing: Every five seconds in the Barometer/Thermometer Mode  
 Other: Calibration; Manual measurement (button operation)

## Altimeter:

Measurement range: -700 to 10,000 m (or -2,300 to 32,800 ft.) without reference altitude  
 Display range: -10,000 to 10,000 m (or -32,800 to 32,800 ft.)  
*Negative values can be caused by readings produced based on a reference altitude or due to atmospheric conditions.*  
 Display unit: 5 m (or 20 ft.)  
 Current Altitude Data: 5-second intervals for 1 hour (0'05), or 5-second interval for first 3 minutes followed by 2-minute interval for next 10 hours (2'00)  
 Altitude Memory Data:  
 Manual save records: 14 (altitude, date, time)  
 Auto save values: High altitude (with month, day, time of reading), low altitude (with month, day, time of reading), cumulative ascent (with month, day, time of first reading), cumulative descent (with month, day, time of first reading)  
 Other: Reference altitude setting; Altitude graph; Altitude differential; Altitude auto measurement method (0'05 or 2'00)

## Bearing Sensor Precision:

Direction: Within ±10°  
 Values are guaranteed for a temperature range of -10°C to 40°C (14°F to 104°F).  
 North indicated by second hand; Error of ±2° for each mark in the scale.

## Pressure Sensor Precision:

	Conditions (Altitude)	Altimeter	Barometer
Fixed temperature	0 to 6000 m 0 to 19680 ft.	± (altitude differential × 2% + 15 m) m ± (altitude differential × 2% + 50 ft.) ft.	± (pressure differential × 2% + 2 hPa) hPa ± (pressure differential × 2% + 0.059 inHg) inHg
	6000 to 10000 m 19680 to 32800 ft.	± (altitude differential × 2% + 25 m) m ± (altitude differential × 2% + 90 ft.) ft.	
Effect of variable temperature	0 to 6000 m 0 to 19680 ft.	± 50 m every 10°C ± 170 ft. every 50°F	± 5 hPa every 10°C ± 0.148 inHg every 50°F
	6000 to 10000 m 19680 to 32800 ft.	± 70 m every 10°C ± 230 ft. every 50°F	

\* Values are guaranteed for a temperature range of -10°C to 40°C (14°F to 104°F).  
 \* Precision is lessened by strong impact to either the watch or the sensor, and by temperature extremes.

## Temperature Sensor Precision:

±2°C (±3.6°F) in range of -10°C to 60°C (14.0°F to 140.0°F)

## Stopwatch:

Measuring unit: 1/100 second  
 Measuring capacity: 59' 59.99"  
 Measuring modes: Elapsed time, split time, two finishes

## Countdown Timer:

Measuring unit: 1 second  
 Countdown start time setting range: 60 minutes (1-minute unit)

E-104

E-105

**Alarms:** 5 Daily alarms; Hourly time signal

**World Time:** 29 cities (29 time zones)

Other: Daylight Saving Time/Standard Time; Home City/World Time City switching

**Illumination:** LED (light-emitting diode); Selectable illumination duration (approximately 1.5 seconds or 3 seconds); Auto Light Switch on/off (Full Auto LED Light lights only in the dark)

**Other:** Battery power indicator; Power Saving; Low-temperature resistance (-10°C/14°F); Button operation tone on/off; Hand home position auto adjustment; Time Formats (12-hour and 24-hour)

**Power Supply:** Solar cell and one rechargeable battery

Approximate battery operating time: 5 months (from full charge to Level 4) under the following conditions:

- Watch not exposed to light
- Internal timekeeping
- Display on 18 hours per day, sleep state 6 hours per day
- 1 illumination operation (1.5 seconds) per day
- 10 seconds of alarm operation per day
- 10 compass operations per week
- 10 hours of altimeter measurement, once per month
- Barometric pressure readings and graph updating every two hours (12 times per day)
- 4 minutes of signal reception per day

Frequent use of illumination runs down the battery. Particular care is required when using the auto light switch (page E-94).

E-106

## City Code Table

City Code	City	UTC Offset/ GMT Differential	City Code	City	UTC Offset/ GMT Differential
PAGO PAGO (PPG)	Pago Pago	-11	KABUL (KBL)	Kabul	+4.5
HONOLULU (HNL)	Honolulu	-10	KARACHI (KHI)	Karachi	+5
ANCHORAGE (ANC)	Anchorage	-9	DELHI (DEL)	Delhi	+5.5
LOS ANGELES (LAX)	Los Angeles	-8	KATHMANDU (KTM)	Kathmandu	+5.75
DENVER (DEN)	Denver	-7	DHAKA (DAC)	Dhaka	+6
CHICAGO (CHI)	Chicago	-6	YANGON (RGN)	Yangon	+6.5
NEW YORK (NYC)	New York	-5	BANGKOK (BKK)	Bangkok	+7
SANTIAGO (SCL)	Santiago	-4	HONG KONG (HKG)	Hong Kong	+8
RIO	Rio De Janeiro	-3	TOKYO (TYO)	Tokyo	+9
PRAIA (RAI)	Praia	-1	ADELAIDE (ADL)	Adelaide	+9.5
UTC		0	SYDNEY (SYD)	Sydney	+10
LONDON (LON)	London		NOUMEA (NOU)	Noumea	+11
PARIS (PAR)	Paris	+1	WELLINGTON (WLG)	Wellington	+12
ATHENS (ATH)	Athens	+2			
JEDDAH (JED)	Jeddah	+3			
TEHRAN (THR)	Tehran	+3.5			
DUBAI (DXB)	Dubai	+4			

- Based on data as of July 2010.
- The rules governing global times (GMT differential and UTC offset) and summer time are determined by each individual country.

L-1