

Contents

Precautions

- Operating Precautions
- User Maintenance
- Battery
- Mobile Link Precautions

Before Getting Started...

- General Guide
- Watch Face Items
- Navigating Between Modes
- Mode Overview
- Using the Crown
- Hand and Day Indicator Movement
- Charging
- Useful Features

Linking with a Phone

- Getting Ready
- Auto Time Adjustment
- Viewing Stopwatch Data
- Setting the Alarm
- Configuring World Time Settings
- Adjusting Hand and Day Indicator Alignment
- Phone Finder
- Configuring Watch Settings
- Changing the Home City Summer Time Setting
- Checking the Watch Charge Level
- Connection
 - Connecting with a Phone
 - Canceling a Connection with a Phone
 - Using the Watch in a Medical Facility or Aircraft
 - Unpairing
 - If you purchase another phone

Time Adjustment

- Using Watch Operations to Adjust the Time and Day Settings
- Configuring Dual Time Settings
- Moving to Another Time Zone

Alarm

- Using CASIO WATCHES to Configure Alarm Settings
- Configuring Alarm Settings
- Turning Off the Alarm

Stopwatch

- Measuring Elapsed Time
- Flyback Timing (Lap Timing)
- Example: Recording a Race Lap Time
- Checking the Difference Between the Current and Previous Lap Times

Adjusting Hand and Day Indicator Alignment

- Using CASIO WATCHES to Adjust Hand and Day Indicator Alignment
- Adjusting Hand and Day Indicator Alignment

Other Settings

- Resetting Watch Settings

Other Information

- Summer Time Switching
- Supported Phones
- Specifications
- Copyrights and Registered Copyrights

Troubleshooting

Precautions

Operating Precautions

● Water Resistance

- The information below applies to watches with WATER RESIST or WATER RESISTANT marked on the back cover.

Water Resistance Under Daily Use

Marking on watch front or on back cover	No BAR mark
---	-------------

Example of Daily Use

Hand washing, rain	Yes
Water-related work, swimming	No
Windsurfing	No
Skin diving	No

Enhanced Water Resistance Under Daily Use

5 Atmospheres

Marking on watch front or on back cover	5BAR
---	------

Example of Daily Use

Hand washing, rain	Yes
Water-related work, swimming	Yes
Windsurfing	No
Skin diving	No

10 Atmospheres

Marking on watch front or on back cover	10BAR
---	-------

Example of Daily Use

Hand washing, rain	Yes
Water-related work, swimming	Yes
Windsurfing	Yes
Skin diving	Yes

20 Atmospheres

Marking on watch front or on back cover	20BAR
---	-------

Example of Daily Use

Hand washing, rain	Yes
Water-related work, swimming	Yes
Windsurfing	Yes
Skin diving	Yes

- Do not use your watch for scuba diving or other types of diving that requires air tanks.
- Watches that do not have WATER RESIST or WATER RESISTANT marked on the back cover are not protected against the effects of sweat. Avoid using such a watch under conditions where it will be exposed to large amounts of sweat or moisture, or to direct splashing with water.
- Even if a watch is water resistant, note the usage precautions described below. Such types of use reduce water resistance performance and can cause fogging of the glass.
 - Do not operate the crown or buttons while your watch is submerged in water or wet.
 - Avoid wearing your watch while in the bath.
 - Do not wear your watch while in a heated swimming pool, sauna, or any other high temperature/high humidity environment.
 - Do not wear your watch while washing your hands or face, while doing housework, or while performing any other task that involves soaps or detergents.
- After submersion in seawater, use plain water to rinse all salt and dirt from your watch.
- To maintain water resistance, have the gaskets of your watch replaced periodically (about once every two or three years).
- A trained technician will inspect your watch for proper water resistance whenever you have its battery replaced. Battery replacement requires the use of special tools. Always request battery replacement from your original retailer or from an authorized CASIO service center.
- Some water-resistant watches come with fashionable leather bands. Avoid swimming, washing, or any other activity that causes direct exposure of a leather band to water.
- The inside surface of the watch glass may fog when the watch is exposed to a sudden drop in temperature. No problem is indicated if the fogging clears up relatively quickly. Sudden and extreme temperature changes (such as coming into an air conditioned room in the summer and standing close to an air conditioner outlet, or leaving a heated room in the winter and allowing your watch to come into contact with snow) can cause it to take longer for glass fogging to clear up. If glass fogging does not clear up or if you notice moisture inside of the glass, immediately stop using your watch and take it to your original retailer or to an authorized CASIO service center.
- Your water-resistant watch has been tested in accordance with International Organization for Standardization regulations.
- Band**
 - Tightening the band too tightly can cause you to sweat and make it difficult for air to pass under the band, which can lead to skin irritation. Do not fasten the band too tightly. There should be enough room between the band and your wrist so you can insert your finger.
 - Deterioration, rust, and other conditions can cause the band to break or come off of your watch, which in turn can cause band pins to fly out of position or to fall out. This creates the risk of your watch falling from your wrist and becoming lost, and also creates the risk of personal injury. Always take good care of your band and keep it clean.
 - Immediately stop using a band if you even notice any of the following: loss of band flexibility, band cracks, band discoloration, band looseness, band connecting pin flying or falling out, or any other abnormality. Take your watch to your original retailer or to a CASIO service center for inspection and repair (for which you will be charged) or to have the band replaced (for which you will be charged).

● Temperature

- Never leave your watch on the dashboard of a car, near a heater, or in any other location that is subject to very high temperatures. Do not leave your watch where it will be exposed to very low temperatures. Temperature extremes can cause your watch to lose or gain time, to stop, or otherwise malfunction.

● Impact

- Your watch is designed to withstand impact incurred during normal daily use and during light activity such as playing catch, tennis, etc. Dropping your watch or otherwise subjecting it to strong impact, however, can lead to malfunction. Note that watches with shock-resistant designs (G-SHOCK, BABY-G, G-MS) can be worn while operating a chain saw or engaging in other activities that generate strong vibration, or while engaging in strenuous sports activities (motocross, etc.)

● Magnetism

- The hands of analog and combination (analog-digital) watches are moved by a motor that uses magnetic force. When such a watch is close to a device (audio speakers, magnetic necklace, cell phone, etc.) that emits strong magnetism, the magnetism can cause timekeeping to slow down, speed up, or stop, resulting in the incorrect time being displayed.
- Very strong magnetism (from medical equipment, etc.) should be avoided because it can cause malfunction of your watch and damage to electronic components.

● Electrostatic Charge

- Exposure to very strong electrostatic charge can cause your watch to display the wrong time. Very strong electrostatic charge even can damage electronic components.

● Chemicals

- Do not allow your watch to come into contact with thinner, gasoline, solvents, oils, or fats, or with any cleaners, adhesives, paints, medicines, or cosmetics that contain such ingredients. Doing so can cause discoloration of or damage to the resin case, resin band, leather, and other parts.

● Storage

- If you do not plan to use your watch for a long time, thoroughly wipe it free of all dirt, sweat, and moisture, and store it in a cool, dry place.

● Resin Components

- Allowing your watch to remain in contact with other items or storing it together with other items for long periods while it is wet can cause color on resin components to transfer to the other items, or the color of the other items to transfer to the resin components of your watch. Be sure to dry off your watch thoroughly before storing it and make sure it is not in contact with other items.
- Leaving your watch where it is exposed to direct sunlight (ultraviolet rays) for long periods or failure to clean dirt from your watch for long periods can cause it to become discolored.
- Friction caused by certain conditions (strong external force, sustained rubbing, impact, etc.) can cause discoloration of painted components.
- If there are printed figures on the band, strong rubbing of the printed area can cause discoloration.
- Leaving your watch wet for long periods can cause fluorescent color to fade. Wipe the watch dry as soon as possible after it becomes wet.
- Semi-transparent resin parts can become discolored due to sweat and dirt, and if exposed to high temperatures and humidity for long periods.
- Daily use and long-term storage of your watch can lead to deterioration, breaking, or bending of resin components. The extent of such damage depends on usage conditions and storage conditions.

● Leather Band

- Allowing your watch to remain in contact with other items or storing it together with other items for long periods while it is wet can cause the color of the leather band to transfer to the other items or the color of the other items to transfer to the leather band. Be sure to dry off your watch thoroughly with a soft cloth before storing it and make sure it is not in contact with other items.
- Leaving a leather band where it is exposed to direct sunlight (ultraviolet rays) for long periods or failure to clean dirt from a leather band for long periods can cause it to become discolored.

CAUTION:

Exposing a leather band to rubbing or dirt can cause color transfer and discoloration.

● Metal Components

- Failure to clean dirt from metal components can lead to formation of rust, even if components are stainless steel or plated. If metal components exposed to sweat or water, wipe thoroughly with a soft, absorbent cloth and then place the watch in a well-ventilated location to dry.
- Use a soft toothbrush or similar tool to scrub the metal with a weak solution of water and a mild neutral detergent, or with soapy water. Next, rinse with water to remove all remaining detergent and then wipe dry with a soft absorbent cloth. When washing metal components, wrap the watch case with kitchen plastic wrap so it does not come into contact with the detergent or soap.

● Bacteria and Odor Resistant Band

- The bacteria and odor resistant band protects against odor generated by the formation of bacteria from sweat, which ensures comfort and hygiene. In order to ensure maximum bacteria and odor resistance, keep the band clean. Use an absorbent soft cloth to thoroughly wipe the band clean of dirt, sweat, and moisture. A bacteria and odor resistant band suppresses the formation of organisms and bacteria. It does not protect against rash due to allergic reaction, etc.

Note that CASIO Computer Co., Ltd. assumes no responsibility for any damage or loss suffered by you or any third party arising through the use of your watch or its malfunction.

User Maintenance

● Caring for Your Watch

Remember that you wear your watch next to your skin, just like a piece of clothing. To ensure your watch performs at the level for which it is designed, keep it clean by frequently wiping with a soft cloth to keep your watch and band free of dirt, sweat, water and other foreign matter.

- Whenever your watch is exposed to sea water or mud, rinse it off with clean fresh water.
- For a metal band or a resin band with metal parts, use a soft toothbrush or similar tool to scrub the band with a weak solution of water and a mild neutral detergent, or with soapy water. Next, rinse with water to remove all remaining detergent and then wipe dry with a soft absorbent cloth. When washing the band, wrap the watch case with kitchen plastic wrap so it does not come into contact with the detergent or soap.
- For a resin band, wash with water and then wipe dry with a soft cloth. Note that sometimes a smudge like pattern may appear on the surface of a resin band. This will not have any effect on your skin or clothing. Wipe with a cloth to remove the smudge pattern.
- Clean water and sweat from a leather band by wiping with a soft cloth.
- Not operating a watch crown, buttons, or rotary bezel could lead to later problems with their operation. Periodically rotate the crown and rotary bezel, and press buttons to maintain proper operation.

● Dangers of Poor Watch Care

Rust

- Though the metal steel used for your watch is highly rust-resistant, rust can form if your watch is not cleaned after it becomes dirty.
 - Dirt on your watch can make it impossible for oxygen to come into contact with the metal, which can lead to breakdown of the oxidization layer on the metal surface and the formation of rust.
- Rust can cause sharp areas on metal components and can cause band pins to fly out of position or to fall out. If you ever notice any abnormality immediately stop using your watch and take it to your original retailer or to an authorized CASIO service center.
- Even if the surface of the metal appears clean, sweat and rust in crevasses can soil the sleeves of clothing, cause skin irritation, and even interfere with watch performance.

Premature Wear

- Leaving sweat or water on a resin band or bezel, or storing your watch an area subject to high moisture can lead to premature wear, cuts, and breaks.

Skin Irritation

- Individuals with sensitive skin or in poor physical condition may experience skin irritation when wearing a watch. Such individuals should keep their leather band or resin band particularly clean. Should you ever experience a rash or other skin irritation, immediately remove your watch and contact a skin care professional.

Battery

- The special rechargeable battery used by your watch is not intended to be removed or replaced by you. Use of a rechargeable battery other than the special one specified for your watch can damage your watch.
- The rechargeable (secondary) battery is charged when the solar panel is exposed to light, so it does not require regular replacement as the primary battery requires. Note, however, that long use or operating conditions can cause the capacity or charging efficiency of the rechargeable battery to deteriorate. If you feel that the amount of operation provided by charging is too short, contact your original retailer or CASIO service center.

Mobile Link Precautions

● Legal Precautions

- This watch complies with or has received approval under the radio laws of various countries and geographical areas. Using this watch in an area where it does not comply with or has not received approval under applicable radio laws may be a criminal offense. For details, visit the CASIO Website.

<https://world.casio.com/ce/BLE/>

- Use of this watch inside of aircraft is restricted under the aviation laws of each country. Be sure to follow the instructions of airline personnel.

● Precautions when using Mobile Link

- When using this watch in combination with a phone, keep the watch and phone close to each other. A range of two meters is recommended as a guideline, but the local environment (walls, furniture, etc.), the structure of a building, and other factors may require a much closer range.
- This watch can be affected by other devices (electrical devices, audio-visual equipment, office equipment, etc.) In particular, it can be affected by operation of a microwave oven. The watch may not be able to communicate normally with a phone if a microwave oven is operating nearby. Conversely, this watch may cause noise in radio reception and the video image of a TV.
- Bluetooth of this watch uses the same frequency band (2.4 GHz) as wireless LAN devices, and use of such devices in close proximity of this watch may result in radio interference, slower communication speeds and noise for the watch and the wireless LAN device, or even communication failure.

● Stopping Radio Wave Emission by This Watch

The watch is emitting radio waves whenever the second hand is pointing to [R] or . In addition, the watch also connects phone automatically four times a day to adjust its time setting.

When in a hospital, on an aircraft, or in any other area where the use of radio waves is not allowed, use the operation below to stop radio wave generation.

- Stopping Radio Wave Generation
Press any button to terminate the Bluetooth connection.

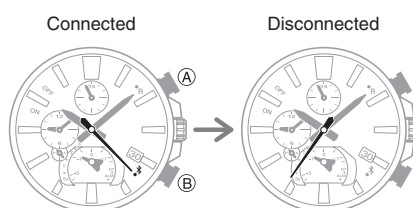

- Disabling Auto Time Adjustment
Configure CASIO WATCHES settings to disable time adjustment between the watch and phone.

[Using the Watch in a Medical Facility or Aircraft](#)

Before Getting Started...

This section provides an overview of the watch and introduces convenient ways it can be used.

Watch Features

- **Phone Linking**

The watch supports connection and communication with a Bluetooth capable phone.

- **Stopwatch**

You can measure elapsed time up to 24 hours in one-second units.

- **Dual Time**

Dual Time lets you keep track of the current time in another time zone in addition to your current location's time.

- **Alarm**

An alarm sounds whenever a time specified by you is reached.

Note

- The illustrations included in this operation guide have been created to facilitate explanation. An illustration may differ somewhat from the item it represents.

General Guide

The terms below are for the Calendar Mode.

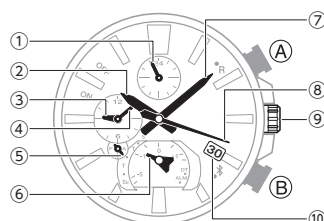

- ① 24-hour hand
- ② Hour hand
- ③ Dual Time hour hand
- ④ Dual Time minute hand
- ⑤ Dual Time 24-hour hand
- ⑥ Function hand
- ⑦ Minute hand
- ⑧ Second hand
- ⑨ Crown
- ⑩ Day indicator

A button

Press this button to start a stopwatch elapsed time operation.

Hold down this button for at least two seconds in the Stopwatch Mode to return to the Calendar Mode.

B button

Press this button to connect with the paired phone and adjust the watch's time setting.

Watch Face Items

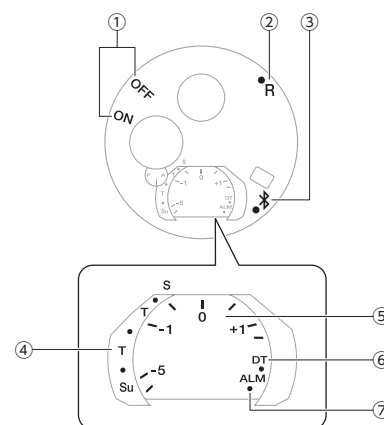

- ① **Alarm on/off setting**
While you are configuring alarm settings, the second hand indicates whether the current alarm is enabled or disabled.
[ON]: Alarm enabled
[OFF]: Alarm disabled
- ② **[R]**
When the watch is standing by for connection with a phone, the second hand points to [R].
- ③ **☎**
The second hand points to this mark while there is a connection between the watch and a phone.
- ④ **Day of week**
In the Calendar Mode, the function hand points to the day of the week in the Home City.
- ⑤ **Target time indicator**
In the Stopwatch Mode, the function hand indicates the difference between the current and previous lap times.
- ⑥ **[DT]**
While Dual Time is in use, the function hand points to [DT].
- ⑦ **[ALM]**
While the alarm time setting is being configured, the function hand points to [ALM].

Navigating Between Modes

Pressing (A) in the Calendar Mode enters the Stopwatch Mode and starts an elapsed time measurement operation.

Holding down (A) for at least two seconds in the Stopwatch Mode enters the Calendar Mode.

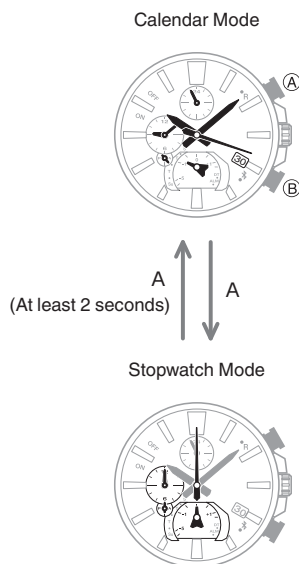

Connecting with a Phone

Hold down (B) for at least two seconds until the second hand points to [R] twice.

- To disconnect, press any button.

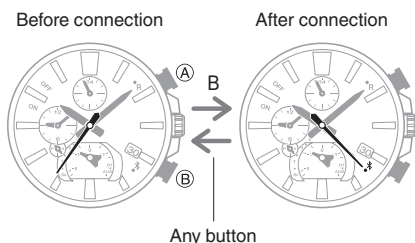

Mode Overview

Calendar Mode

The main hour, minute, and second hands indicate the current time.

The small hour and minute hands show another time (Dual Time).

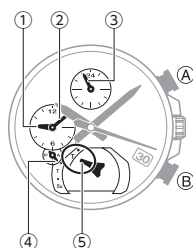

- Dual Time hour
- Dual Time minute
- Current location time (24-hour time)
One revolution every 24 hours.
- Dual Time hour (24-hour hand)
The hand points to the A-side for a.m. times, and to the P-side for p.m. times.
- Day of the week at current location

Starting a Stopwatch Elapsed Time Operation

Press (A).

Connecting with a Paired Phone to Correct the Watch's Time

Hold down (B) for at least 0.5 seconds until the second hand points to [R].

Searching for a Paired Phone

Hold down (B) for at least four seconds.

Stopwatch Mode

The second hand, and the small hour and minute hands indicate the elapsed stopwatch time.

- The main hour and minute hands indicate the current time.

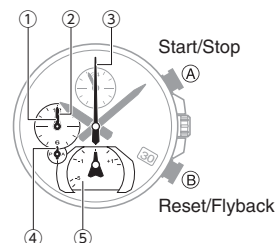

- Stopwatch hours
- Stopwatch minutes
- Stopwatch seconds
- Stopwatch hours (24-hour time)
The hand points to the A-side for hours 0 through 11, and to the P-side for hours 12 through 23.
- Target time indicator
Shows the difference between the current and previous lap times.

Alarm

The small hour and minute hands indicate the alarm time.

The second hand indicates the alarm enabled/disabled setting.

- The main hour and minute hands indicate the current time.

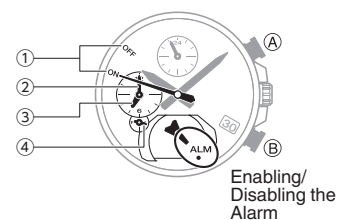

- Alarm enabled/disabled
- Alarm minute
- Alarm hour
- Alarm hour (24-hour time)
The hand points to the A-side for a.m. times, and to the P-side for p.m. times.

Using the Crown

● Fast Forward/Fast Reverse

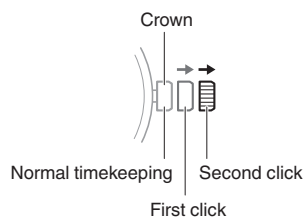

Important!

- To prevent loss of water resistance and/or damage due to impact, be sure to push the crown back in after you are finished using it.
- When pushing the crown back in, take care not to apply too much force.

After pulling out the crown to the first or second click, rotating it quickly in succession in either direction will start a fast forward or fast reverse operation. While a fast forward operation is in progress, quickly rotating the crown in succession again will increase the speed even further.

● Stopping Fast Forward/Fast Reverse

Rotate the crown in the direction opposite that of the ongoing operation or press any button.

Note

- If you do not perform any operation for about two minutes after pulling out the crown, crown operations will automatically become disabled. If that happens, push the crown back in and then pull it out again.

Hand and Day Indicator Movement

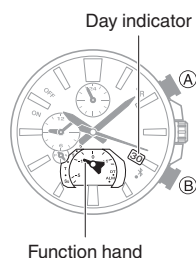

● Function Hand and Day Indicator Movement

Changing the day setting of the watch will also cause the function hand to move.

● Day

- It can take anywhere from about 50 seconds to about 3 minutes and 20 seconds for the day indicator to change after timekeeping reaches midnight. At this time, the function hand moves as the day indicator changes.
- The day may not be indicated correctly while the watch's crown is pulled out.

Charging

This watch runs on power supplied from a rechargeable (secondary) battery that is charged by a solar panel. The solar panel is integrated into the face of the watch, and power is generated whenever the face is exposed to light.

● Charging the Watch

When you are not wearing the watch, put it in a location where it is exposed to bright light.

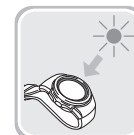

While you are wearing the watch, make sure that its face (solar panel) is not blocked from light by the sleeve of your clothing. Power generation efficiency is reduced even when the face of the watch is blocked only partially.

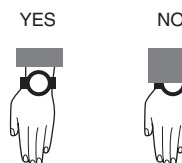

Important!

- Depending on light intensity and local conditions, the watch may become hot to the touch when exposed to light for charging. Take care to avoid burn injury after charging. Also, avoid charging the watch under high-temperature conditions like the ones described below.
 - On the dashboard of a vehicle parked in the sun
 - Near an incandescent light bulb or other source of heat
 - Under direct sunlight or in other hot areas for long periods

● Remaining Charge and Dead Battery

You can determine if the charge level is low by checking the hand movement. Functions become disabled as battery power goes low.

Important!

- Should the battery go low or go dead, expose the face (solar panel) to light as soon as possible.

Note

- Exposing the watch face to light after the battery goes dead will cause the second hand to revolve counterclockwise until it stops at second 57. This indicates charging has started.

Low Battery Power

The second hand jumps at two-second intervals.

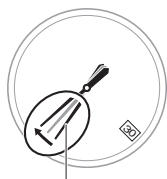

Second hand

Dead Battery

All hands and the day indicator are stopped.

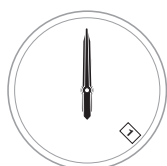

● Charging Time Guidelines

The table below shows guidelines for approximate charging times.

Charging Times Required for 1 Day of Operation

Light Level (Lux)	Approximate Charging Time
50,000	8 minutes
10,000	30 minutes
5,000	48 minutes
500	8 hours

Charge Recovery Times

- Sunny day, outdoors (50,000 lux)

Dead battery → Medium charge	2 hours
Medium charge → High charge	17 hours
High charge → Full charge	5 hours

- Sunny day, near a window (10,000 lux)

Dead battery → Medium charge	5 hours
Medium charge → High charge	64 hours
High charge → Full charge	17 hours

- Overcast day, near a window (5,000 lux)

Dead battery → Medium charge	8 hours
Medium charge → High charge	103 hours
High charge → Full charge	28 hours

- Indoor fluorescent lighting (500 lux)

Dead battery → Medium charge	90 hours
Medium charge → High charge	-
High charge → Full charge	-

Note

- Actual charging time depends on the charging environment, watch settings, and other factors.

● Power Saving

Leaving the watch in a dark location for about one hour between the hours of 10 p.m. and 5:50 a.m. will cause the second hand to stop, and the watch to enter Level 1 power saving. If the watch is left in this condition for six or seven days, all hands will stop and the watch will enter Level 2 power saving.

Level 1 :

Basic timekeeping functions are operational.

Level 2 :

Only the day indicator is operational.

Note

- Note that the watch also may enter the power saving state if its face is blocked from light by your sleeve while you are wearing it.
- The watch will enter power saving when it is in one of the modes below.
 - Calendar Mode
 - Stopwatch Mode (reset to all zeros)

● Recovering from Power Saving Operation

Press any button, perform a crown operation, or place the watch in a well-lit area to recover from power saving.

Useful Features

Pairing the watch with your phone makes a number of the watch's features easier to use.

Auto time correction

[Auto Time Adjustment](#)

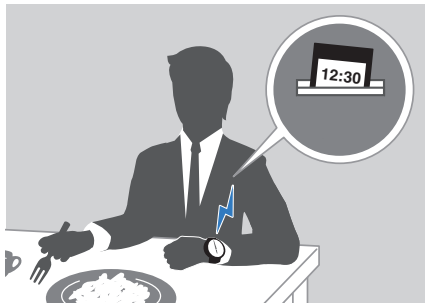

Selection of More Than 300 World Time cities

[Configuring World Time Settings](#)

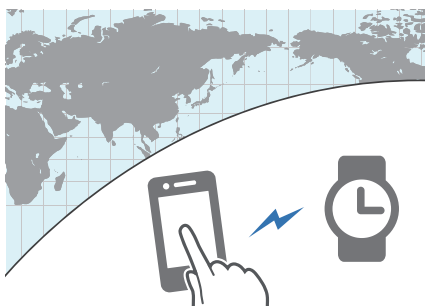

In addition, a number of other watch settings can be configured using your phone.

To transfer data to a watch and to configure settings, you first need to pair the watch with your phone.

[Getting Ready](#)

- Your phone needs to have the “CASIO WATCHES” phone app installed to pair with the watch.

Linking with a Phone

While there is a Bluetooth connection between the watch and phone (Mobile Link), the watch's current time setting is corrected automatically. You can also change the watch's other settings.

Note

- This function is available only while the CASIO WATCHES phone app is running on the phone.
- This section describes watch and phone operations.
 - : Watch operation
 - : Phone operation

Getting Ready

To use your watch in combination with a phone, you first need to pair them. Perform the steps below to pair the watch with a phone.

- ① **Install the required app on your phone.**

In Google Play or the App Store, search for the “CASIO WATCHES” phone app and install it on your phone.

- ② **Configure Bluetooth settings.**

Enable the phone's Bluetooth.

Note

- For details about setting procedures, see your phone documentation.

- ③ **Pair the watch with a phone.**

Before you can use the watch in combination with a phone, you first need to pair them.

1. Move the phone to be paired with close to (within one meter of) the watch.
 2. Tap the “CASIO WATCHES” icon.
 3. Tap the of the “My Watch” tab.
 4. Perform the operation shown on the phone screen to register the watch to the CASIO WATCHES phone app.
 5. Hold down (B) for at least two seconds until the second hand points to [R].
When pairing is complete, the second hand will move to .
- To pair a watch that is already paired with one phone to another phone, press and hold (B) until the second hand points to [R] twice.



- If pairing fails, the watch returns to the state it was in before starting this procedure. Perform the pairing procedure again from the beginning.

Note

- The first time you start up the CASIO WATCHES phone app, a message will appear on your phone asking if you want to enable location information acquisition. Configure settings to allow background use of location information.

Auto Time Adjustment

The watch will connect with a phone at preset times each day and adjust its time settings.

● Using This Function

Your watch adjusts its time setting four times a day according to a preset schedule. If you leave the watch in the Calendar Mode, it will perform the adjustment operation automatically as you go about your daily life, without any operation required by you.

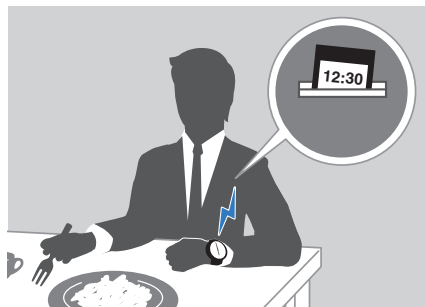

Important!

- The watch may not be able to perform auto time correction under the conditions described below.
 - While the watch is too far away from its paired phone
 - While communication is not possible due to radio interference, etc.
 - While the phone is updating its system
 - While the CASIO WATCHES phone app is not running on the phone

Note

- If the watch does not indicate the correct time even if it is able to connect with a phone, adjust the hand and day indicator positions.
 - [Adjusting Hand and Day Indicator Alignment](#)
- If there is a World Time City specified with the CASIO WATCHES phone app, its time will also be corrected automatically.
- The watch will connect with the phone and perform auto time correction at around 12:30 a.m., 6:30 a.m., 12:30 p.m. and 6:30 p.m. The connection is automatically terminated after auto time correction is complete.

● Triggering Immediate Time Correction

The watch's time setting will be corrected automatically whenever you establish a connection between the watch and a phone. Whenever you want to trigger immediate time correction, perform the procedure below to connect with a phone.

1. Move the phone close to (within one meter of) the watch.
2. Enter the Calendar Mode.
 - [Navigating Between Modes](#)
3. Hold down (B) for at least 0.5 seconds until the second hand points to [R]. Release the button as soon as the second hand points to [R].

When the watch connects with a phone, the second hand will normally move to and then the watch's time setting will be adjusted.

- The connection is terminated automatically after time correction is complete.

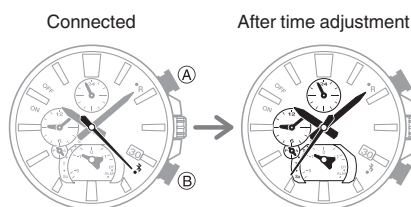

Viewing Stopwatch Data

This section explains how to send lap times (up to 200 records) that are stored in watch memory, as well as other data to your phone for viewing with CASIO WATCHES.

● Sending Stopwatch Data to a Phone

Use the procedure below to send data from the watch to a phone.

1. Tap the "CASIO WATCHES" icon.
2. Hold down (B) for at least two seconds until the second hand points to [R] twice.

This establishes a connection between the watch and phone.

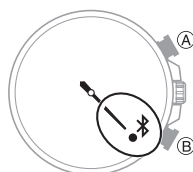

3. Perform the operation shown on the phone screen to transfer data measured by the watch to the phone.

After data transfer is complete, a list of the measurement data will appear on the phone display.

- Tapping a stopwatch data item displays its details.

● Checking a Lap Time

Use the CASIO WATCHES phone app to check the data you sent to the phone.

1. Tap the "CASIO WATCHES" icon.
2. Perform the operation shown on the phone screen to view the measurement data you want.

Note

- Tapping "Edit" displays a screen that you can use to change the data item title and to delete lap time data.

Setting the Alarm

1. Tap the "CASIO WATCHES" icon.
2. Hold down (B) for at least two seconds until the second hand points to [R] twice.

This establishes a connection between the watch and phone.



3. Perform the operation shown on the phone screen to configure alarm time settings.

Configuring World Time Settings

Specifying a World Time City with the CASIO WATCHES phone app causes the watch's World Time City to change accordingly. The standard time/summer time setting of the World Time will be corrected automatically without any watch operation required by you.

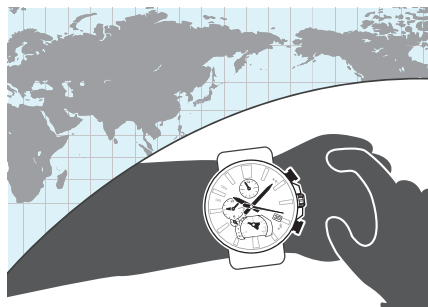

Note

- The CASIO WATCHES phone app World Time lets you select from among approximately 300 cities as the World Time City.

• To select a World Time City

1. Tap the "CASIO WATCHES" icon.
2. Hold down (B) for at least two seconds until the second hand points to [R] twice. This establishes a connection between the watch and phone.

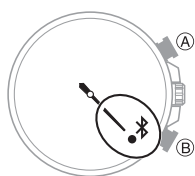

3. Perform the operation shown on the phone screen. The World Time setting will be reflected on the watch.
 - You can determine whether a World Time is a.m. or p.m. by checking the position of the small 24-hour hand.

World Time hour (24-hour)

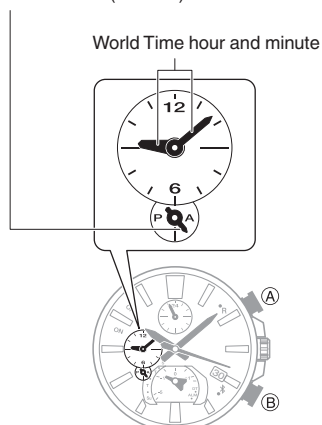

• Configuring the Summer Time Setting

1. Tap the "CASIO WATCHES" icon.
2. Hold down (B) for at least two seconds until the second hand points to [R] twice. This establishes a connection between the watch and phone.

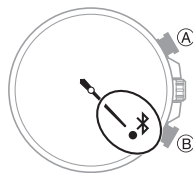

3. Perform the operation shown on the phone screen to select a summer time setting.
 - "Auto"
 - The watch switches between standard time and summer time automatically.
 - "OFF"
 - The watch always indicates standard time.
 - "ON"
 - The watch always indicates summer time.

Note

- While the summer time setting is "Auto", the watch will switch between standard time and summer time automatically. You do not need to switch between standard time and summer time manually. Even if you are in an area that does not observe summer time, you can leave the watch's summer time setting as "Auto".
- Changing the time setting manually with a watch operation will cancel auto standard time/summer time switching.
- The CASIO WATCHES phone app screen shows information about summer time periods.

• Swapping Your World Time and Home Time

1. Tap the "CASIO WATCHES" icon.
2. Hold down (B) for at least two seconds until the second hand points to [R] twice. This establishes a connection between the watch and phone.



3. Perform the operation shown on the phone screen to swap your Home Time with your World Time.

For example, if your Home City is Tokyo and the World Time City is New York, they will be swapped as shown below.

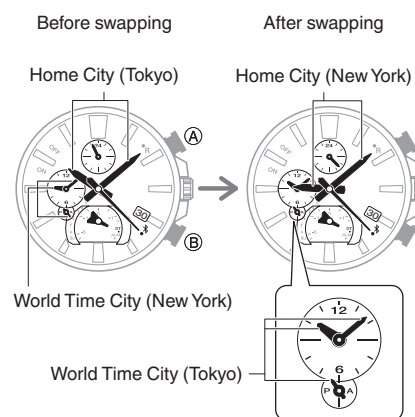

Note

- Auto time adjustment does not work for 24 hours after swapping of the Home Time and World Time.

Adjusting Hand and Day Indicator Alignment

If the hands and/or day indicator are out of alignment even though auto time adjustment is being performed, use CASIO WATCHES to adjust them.

1. Tap the "CASIO WATCHES" icon.
2. Hold down (B) for at least two seconds until the second hand points to [R] twice. This establishes a connection between the watch and phone.

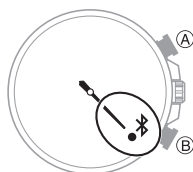

3. Perform the operation shown on the phone screen to correct hand and day indicator alignment.

Phone Finder

You can use phone finder to trigger a tone on the phone to make it easy to find. The tone is forced to sound even if the phone is in vibrate mode.

Important!

- Do not use this function in areas where phone call tones are restricted.
- The tone sounds at a high volume. Do not use this function when listening to phone output over earphones.

1. If the watch is connected with a phone, press any button to terminate the connection. This will cause the watch to enter the Calendar Mode.

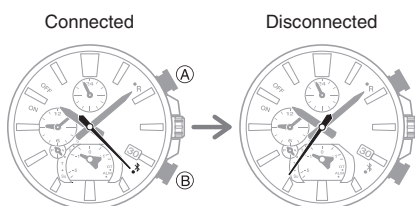

2. Hold down (B) for at least four seconds until the second hand points to ✕ . A connection will be established between the watch and phone, and then the phone's ringtone will sound.
 - It will take a few seconds before the phone tone sounds.

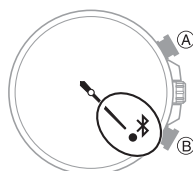

3. Press any button to stop the tone.
 - You can press any watch button to stop the phone tone, but only during the first 30 seconds after it starts to sound.

Configuring Watch Settings

You can use CASIO WATCHES to specify the amount of time until the Bluetooth connection is automatically terminated, and to configure other settings.

1. Tap the "CASIO WATCHES" icon.
2. Hold down (B) for at least two seconds until the second hand points to [R] twice. This establishes a connection between the watch and phone.

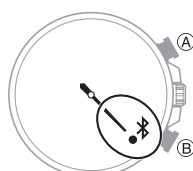

3. Select the setting you want to change and then perform the operation shown on the phone screen.

Changing the Home City Summer Time Setting

1. Tap the "CASIO WATCHES" icon.
2. Hold down (B) for at least two seconds until the second hand points to [R] twice. This establishes a connection between the watch and phone.



3. Perform the operation shown on the phone screen to change your Home City summer time setting.

Checking the Watch Charge Level

Use the procedure below to check the current charge level with CASIO WATCHES.

1. Tap the "CASIO WATCHES" icon.
2. Hold down (B) for at least two seconds until the second hand points to [R] twice. This establishes a connection between the watch and phone.

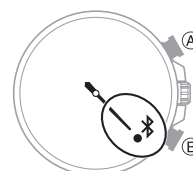

3. Use CASIO WATCHES to check the charge level.

Connection

Connecting with a Phone

This section explains how to establish a Bluetooth connection with a phone that is paired with the watch.

- If the watch is not paired with the phone you want to connect with, refer to the information below and pair them.

③ Pair the watch with a phone.

1. Move the phone close to (within one meter of) the watch.
2. Hold down (B) for at least two seconds until the second hand points to [R] twice.

This establishes a connection between the watch and phone.

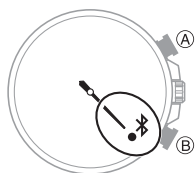

Important!

- If you have problems establishing a connection, it could mean that CASIO WATCHES is not running on the phone. On the phone's Home Screen, tap the "CASIO WATCHES" icon. After the app starts up, hold down the watch's (B) button for at least two seconds.

Note

- The connection will be terminated if you do not perform any operation on the watch or phone for a fixed amount of time.
To specify the connection limit time, perform the following operation with the CASIO WATCHES phone app: "Watch settings" → "Connection time with the app". Next, select a setting of 3 minutes, 5 minutes, or 10 minutes.

Canceling a Connection with a Phone

Pressing any button terminates the Bluetooth connection and returns the second hand to its normal operation.

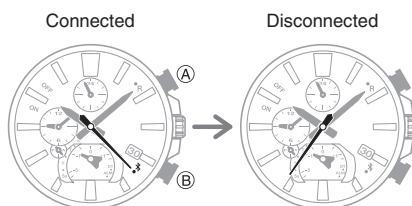

Using the Watch in a Medical Facility or Aircraft

You can use the procedure below to disable auto time adjustment when you are in a hospital, inside an aircraft, or in any other area where use of a phone is prohibited or restricted. To re-enable auto time adjustment, perform the same operation again.

1. Tap the "CASIO WATCHES" icon.
2. Hold down (B) for at least two seconds until the second hand points to [R] twice.
This establishes a connection between the watch and phone.

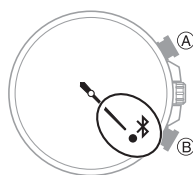

3. Perform the operation shown on the phone screen to enable or disable auto time adjustment.

Unpairing

Use the procedure below to delete pairing information from CASIO WATCHES.

1. If the watch is connected with a phone, press any button to terminate the connection.

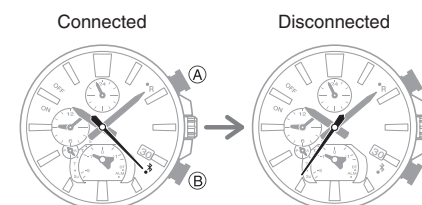

2. Tap the "CASIO WATCHES" icon.
3. Perform the operation shown on the phone screen to unpair.

If you want to disable connection between the watch and a phone, perform the procedure below to delete pairing information from the watch.

1. Pull out the crown to the second click.
This causes the second hand to move to 12 o'clock.

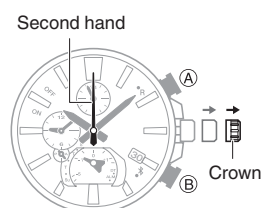

2. Hold down (A) for at least five seconds.
When pairing information is deleted, the second hand will move from to 12 o'clock.
3. Push the crown back in.

If you purchase another phone

You need to perform the pairing operation whenever you want to establish a Bluetooth connection with a phone for the first time.

③ Pair the watch with a phone.

Time Adjustment

Your watch can connect with a phone to obtain information that it uses to correct its date and time setting.

Important!

- Disable auto time adjustment whenever you are in a hospital, inside an aircraft, or in any other area where use of a phone is prohibited or restricted.

[Using the Watch in a Medical Facility or Aircraft](#)

Referring to the information below, configure the time setting in accordance with the method that suits your own lifestyle.

Do you use a phone?

Time correction by connecting with your phone is recommended.

[Auto Time Adjustment](#)



Other than the above.

You can correct time settings by performing operations on the watch.

[Using Watch Operations to Adjust the Time and Day Settings](#)



Using Watch Operations to Adjust the Time and Day Settings

1. Pull out the crown to the second click.

This causes the second hand to move to 12 o'clock, and enables the hour and minute setting operation.

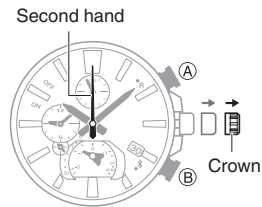

- Each press of (A) cycles through available setting items in the sequence shown below.

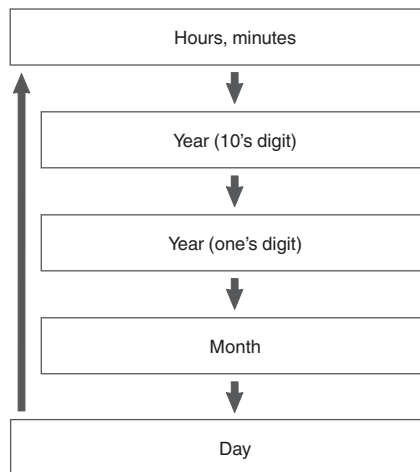

2. Rotate the crown to change the hour and minute settings.

- While checking if the 24-hour hand is indicating a.m. (right side) or p.m. (left side), set the desired time.

3. Press (A).

This enables the year ten's digit setting operation.

4. Rotate the crown to move the second hand to the desired setting for the year ten's digit.



5. Press (A).

This enables the year one's digit setting operation.

6. Rotate the crown to move the second hand to the desired setting for the year one's digit.



7. Press (A).

This enables the month setting operation.

8. Rotate the crown to change the month.

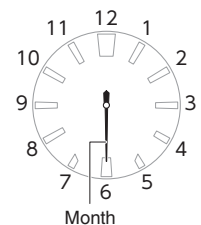

9. Press (A).

This causes the second hand to move to 12 o'clock, and enables the day setting operation. The function hand will move slightly at this time.

- The function hand will move repeatedly while the day setting is being changed.
- [Hand and Day Indicator Movement](#)

10. Rotate the crown to change the day.

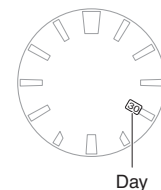

11. On a time signal at the top of a minute, push the crown back in.

Configuring Dual Time Settings

Dual Time lets you keep track of the current time in another time zone in addition to your current location time.

1. Pull out the crown to the first click.

This causes the second hand to move to 12 o'clock, and the function hand to move to [DT].

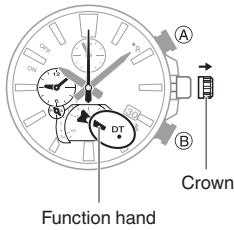

2. Rotate the crown to change the Dual Time setting.

- You can set the Dual Time in 15-minute increments.

Dual Time 24-hour

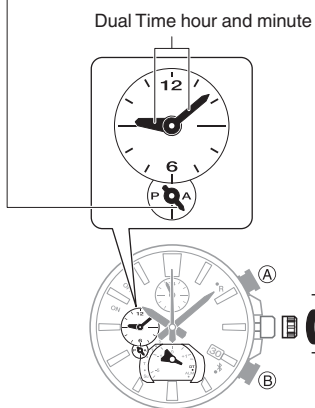

3. Push the crown back in.

Moving to Another Time Zone

Use the procedure below to easily change day and time settings of the watch to a destination location.

● Before Boarding

1. Configure the World Time (Dual Time) setting to the current time at your destination.

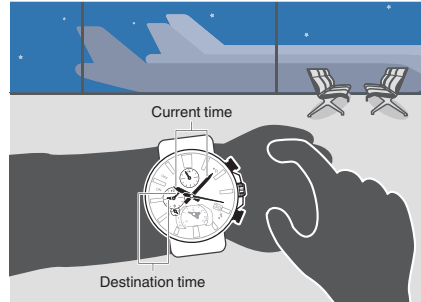

[To select a World Time City](#)

2. Disable auto time adjustment.

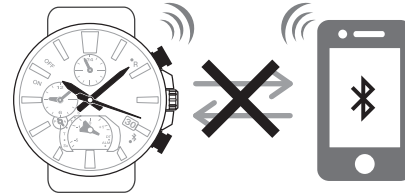

[Using the Watch in a Medical Facility or Aircraft](#)

● After Arriving

1. Swap the origin time zone time with the destination time zone time.

Before swapping

After swapping

Destination time

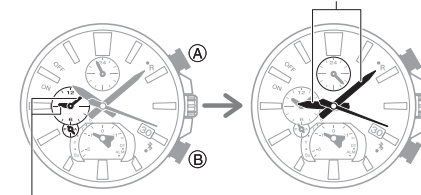

Destination time

[Swapping Your World Time and Home Time](#)

2. Enable auto time adjustment.

[Using the Watch in a Medical Facility or Aircraft](#)

3. Correct the time setting.

[Triggering Immediate Time Correction](#)

Alarm

The watch will beep when an alarm time is reached.

- The alarm sound is muted in the cases described below.

- When battery power is low
- When the watch is at Level 2 power saving

[Power Saving](#)



Using CASIO WATCHES to Configure Alarm Settings

If the watch is paired with a phone, you can also use the CASIO WATCHES phone app to set alarms.

[Setting the Alarm](#)

Configuring Alarm Settings

1. Pull out the crown to the first click.

This causes the second hand to move to 12 o'clock, and the function hand to move to [DT].

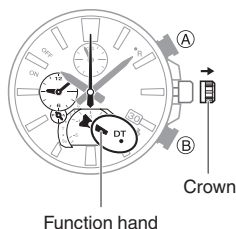

2. Press (A).

This causes the function hand to move to [ALM] and turns on the alarm.

3. Rotate the crown to change the alarm time setting.

- Check the 24-hour hand to see if it is indicating a.m. or p.m. for the alarm time.

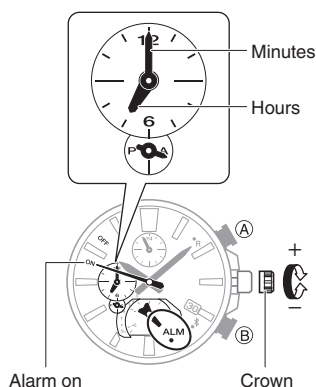

4. Push the crown back in.

● To stop the alarm

To stop the alarm after it starts to sound when an alarm time is reached, press any button.

Note

- A beeper sounds for 10 seconds when an alarm time is reached.

Turning Off the Alarm

If you leave the alarm turned on, it will sound every day at the preset alarm time.

To stop the alarm from sounding, perform the steps below to turn it off.

- To have the alarm sound again, turn it on.

1. Pull out the crown to the first click.

This causes the second hand to move to 12 o'clock, and the function hand to move to [DT].

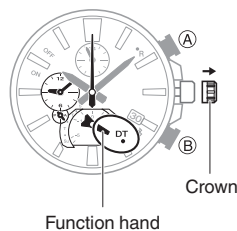

2. Press (A).

This causes the function hand to move to [ALM] and turns on the alarm.

3. Press (B) to move the second hand to off.

- Each press of (B) toggles between on and off.

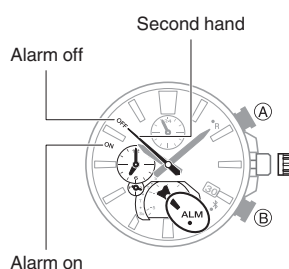

4. Push the crown back in.

Stopwatch

Pressing (A) in the Calendar Mode enters the Stopwatch Mode and starts an elapsed time measurement operation (Direct Start).

The stopwatch measures elapsed time in units of one second up to 23 hours, 59 minutes, 59 seconds (24 hours).



Note

- Direct Start is disabled while there is a Bluetooth connection between the watch and another device.

Measuring Elapsed Time

1. In the Calendar Mode, press (A).

🔍 Navigating Between Modes

This enters the Stopwatch Mode and starts an elapsed time measurement operation.

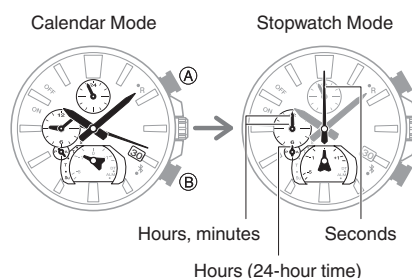

- (A) Start
- ↓
- (A) Stop
- ↓
- (A) Resume
- ↓
- (A) Stop

2. Press (B) to reset the elapsed time to all zeros.

- To return to the Calendar Mode, reset the stopwatch to all zeros and then press (B).

Flyback Timing (Lap Timing)

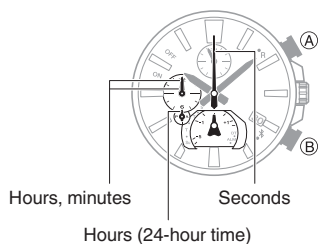

1. In the Calendar Mode, press (A).

[Navigating Between Modes](#)

This enters the Stopwatch Mode and starts an elapsed time measurement operation.

Each press of (B) causes the elapsed time of the section (lap time) to be shown for about 10 seconds.

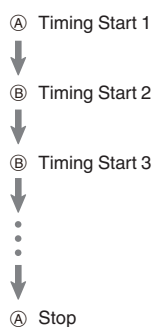

- Elapsed time measurement for the next lap continues internally during the approximately 10 seconds that the lap time is shown.

When the elapsed time exceeds 10 seconds, the hands will return to indicating the current lap time.

Pressing (B) when the next lap time is 10 seconds or less will display that lap time.

2. Press (B) to reset the elapsed time to all zeros.

- To return to the Calendar Mode, reset the stopwatch to all zeros and then press (B).

Lap Times

A lap time is the time elapsed during a specific lap or segment. Lap times are recorded internally by the watch. The watch displays the elapsed time of the current lap.

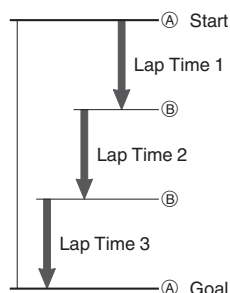

Note

- Lap times can be viewed with CASIO WATCHES after measurement is complete.

[Viewing Stopwatch Data](#)

Example: Recording a Race Lap Time

This section explains how to record lap times while watching a race. It also shows how you can view lap times with CASIO WATCHES after the race is over.

[Lap Times](#)

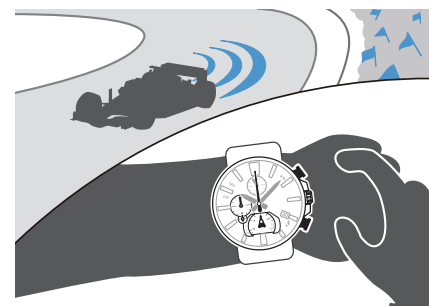

During a race

Measure lap times.

1. In the Calendar Mode, press (A).

[Navigating Between Modes](#)

This enters the Stopwatch Mode and starts an elapsed time measurement operation.

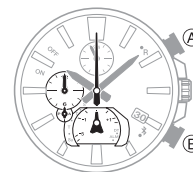

2. Use the operations below to perform a timer operation.

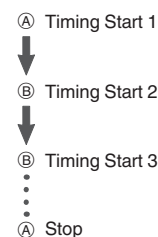

Pressing (B) at the end of each lap will record them in watch memory.

- Lap times are recorded in 1/1000-second units during the first hour of an elapsed time measurement operation.

3. Press (B) to reset the elapsed time to all zeros.

- To return to the Calendar Mode, reset the stopwatch to all zeros and then press (B).

After a race

After the race is finished, you can view the measured lap times with CASIO WATCHES.

[Sending Stopwatch Data to a Phone](#)

[Checking a Lap Time](#)

Checking the Difference Between the Current and Previous Lap Times

You can check the difference between the previous and current lap times while a lap time measurement operation is in progress.

Using This Function

Pressing (B) displays the difference between the current and previous lap times.

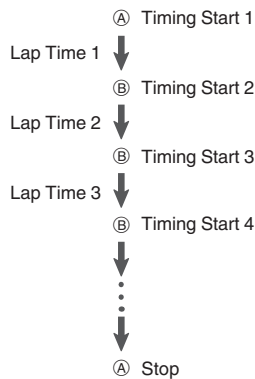

- When you measure a lap time, the function hand indicates the difference between the current and previous lap times.
- From measurement of the second lap time, you can check the difference between the current and previous lap times.

To determine the difference between the current and previous lap times

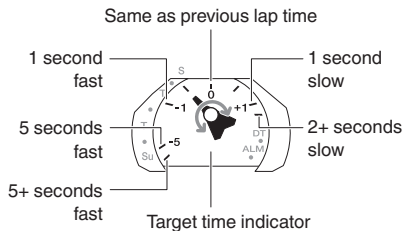

Adjusting Hand and Day Indicator Alignment

Strong magnetism or impact can cause the hands and/or the day indicator to go out of alignment. If this happens, correct hand and day indicator alignment.

Using CASIO WATCHES to Adjust Hand and Day Indicator Alignment

If the watch is paired with a phone, you can also use the CASIO WATCHES phone app to correct hand and day indicator positions.

Adjusting Hand and Day Indicator Alignment

Adjusting Hand and Day Indicator Alignment

1. Pull out the crown to the second click.
This causes the second hand to move to 12 o'clock.
2. Hold down (B) for at least five seconds until the watch beeps. Release the button when you hear the beep.
This causes the second hand to perform one full revolution and enables adjustment of second hand alignment.

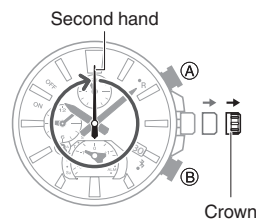

3. Rotate the crown to align the second hand with 12 o'clock.

4. Press (B).

This enables adjustment of hour hand, minute hand, and 24-hour hand alignment.

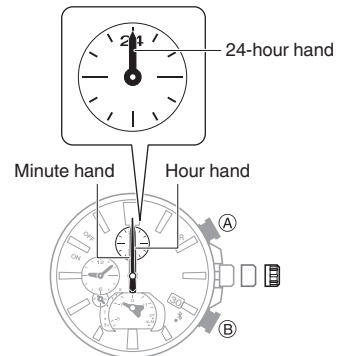

5. Rotate the crown to align the hour hand, minute hand, and 24-hour hand with 12 o'clock.
6. Press (B).

This enables adjustment of small hour hand, small minute hand, and small 24-hour hand alignment.

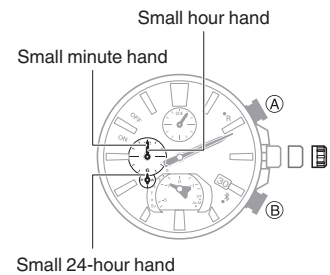

7. Rotate the crown to align the small hour hand, small minute hand, and small 24-hour hand with 12 o'clock.
8. Press (B).

This enables function hand and day indicator alignment.

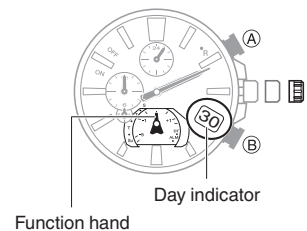

9. If the function hand and/or the day indicator is out of alignment, rotate the crown to adjust them. Move the function hand to 12 o'clock and/or the day to the center of the indicator window.

- The movement ranges of the function hand and day indicator are limited when you rotate the crown. The maximum left-right movement of the function hand is 180 degrees in either direction. The day indicator moves only slightly.
- After the function hand and day indicator are in the positions you want, advance to step 12 of this procedure. If you are unable to make the adjustments you want, go to step 10.

10. Press (B).

Confirm that the day indicator shows "1".

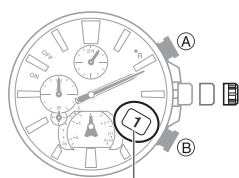

Day indicator

- The function hand will move repeatedly while the day setting is being changed. The function hand may continue to move for about 20 minutes.

[Hand and Day Indicator Movement](#)

11. If "1" is not shown for the day, rotate the crown until "1" is shown for the day.

- Rotating the crown also causes the function hand to move. Move the function hand to 12 o'clock.

12. Push the crown back in.

Note

- Leaving the crown pulled out for more than approximately 30 minutes without performing any operation will automatically cause the adjustment operation to become disabled. If this happens, push the crown back in to its normal position and then pull it out again to restart the procedure from the beginning. Pushing the crown in to its normal position part way through the alignment procedure will cause the hands to return to their normal position. Any alignment you performed up to that point will be applied.

Other Settings

This section explains other watch settings you can configure.

Resetting Watch Settings

This section explains how to return the watch settings below to their initial factory defaults.

- Watch Settings
- Stopwatch
- Alarm

1. Enter the Calendar Mode.

[Navigating Between Modes](#)

2. Pull out the crown to the second click.

This causes the second hand to move to 12 o'clock.

3. Hold down (A) for at least 10 seconds until the second hand performs one full rotation.

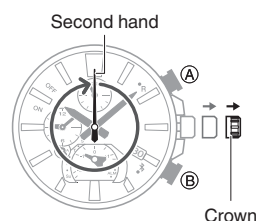

Second hand

Crown

4. Push the crown back in.

Note

- Resetting the watch will also delete information for pairing the watch with a phone, and unpair them.

Other Information

This section provides non-operational information you also need to know. Refer to this information as required.

Summer Time Switching

● Connecting with a Phone to Switch

After the watch is connected with a phone, summer time switching of Home City time and World Time is performed in accordance with the CASIO WATCHES setting (Auto/ON/OFF) as described below.

Auto :

After the watch is connected with a phone, summer time is displayed for the current location time or World Time when it is within the summer time period. Otherwise standard time is displayed.

ON :

The watch always displays summer time.

OFF :

The watch always displays standard time.

● Auto Summer Time Switching

When the watch is connected to a phone, it is sent summer time period information for your Home City. If there is a World Time City specified with CASIO WATCHES, information for that city will also be sent. If the CASIO WATCHES summer time setting is "Auto", the watch will keep track of the summer time period and perform summer time switching automatically, even if it is not connected with the phone.

Supported Phones

For information about phones that can connect with the watch, visit the CASIO website.

https://world.casio.com/os_mobile/wat/

Specifications

Accuracy at normal temperature :

±15 seconds per month when time correction by communication with a phone is not possible.

Timekeeping :

Hour, minute (10-second hand movement), second, day, day of the week, Full Auto Calendar (2000 to 2099)

Dual Time :

Hour, minute, 24-hour

Stopwatch :

Measuring unit: 1 second
 Measuring capacity: 23:59'59" (24 hours)
 Measurement Functions:
 Normal elapsed time measurement, flyback timing
 Direct Start
 Starts stopwatch elapsed time measurement from the Calendar Mode.

Alarm :

Setting units: Hours, minutes
 Beeper: 10 seconds

Mobile Link :

Auto Time Correction
 Time setting corrected automatically at preset time
 One-touch Time Correction
 Manual connection and time correction
 Phone finder
 Watch operation sounds the alert sound of the phone.
 Stopwatch data transfer
 200 measured data records (measurement time, lap time)
 World Time
 Current time for a selection of approximately 300 cities
 Home Time/World Time swapping
 Auto summer time setting
 Automatic switching between standard time and summer time
 Alarm Settings
 Hand alignment correction
 Data Communication Specifications
 Bluetooth®
 Frequency Band: 2400MHz to 2480MHz
 Maximum Transmission: 0 dBm (1 mW)
 Communication range: Up to 2 meters (depends on environment)

Other :

Power Saving, Low Battery Alert

Power Supply :

Solar panel and one rechargeable battery (Type: CTL920)
 Battery nominal voltage: 2.3V

Approximate Battery Life :

Approximately 5 months
 Conditions
 Not exposed to light under the conditions below.
 Auto Time Adjustment: 4 times/day
 Alarm: Once (10 seconds)/day
 Power Saving: 6 hours/day

Specifications are subject to change without notice.

Copyrights and Registered Copyrights

- The Bluetooth® word mark and logos are registered trademarks owned by the Bluetooth SIG, Inc. and any use of such marks by CASIO Computer Co., Ltd. is under license.
- iPhone and App Store are trademarks of Apple Inc. in the United States and other countries.
- iOS is a trademark or registered trademark of Cisco Systems, Inc.
- GALAXY is a registered trademark of Samsung Electronics Co., Ltd.
- Android and Google Play™ are trademarks or registered trademarks of Google LLC.
- Other company names and product names used herein are trademarks or registered trademarks of their respective companies.

Troubleshooting

I can't pair the watch with a phone.

Q1 I've never been able to establish a (pairing) connection between the watch and phone.

Are you using a supported phone model?

Check if the phone model and its operating system are supported by the watch.
 For information about supported phone models, visit the CASIO Website.
https://world.casio.com/os_mobile/wat/

Did you install the CASIO WATCHES phone app on your phone?

The CASIO WATCHES phone app needs to be installed on your phone in order to connect with the watch.
 ① Install the required app on your phone.

Are your phone's Bluetooth settings configured correctly?

Configure the phone's Bluetooth settings. For details about setting procedures, see your phone documentation.
iPhone Users
 • "Settings" → "Bluetooth" → On
 • "Settings" → "Privacy" → "Bluetooth" → "CASIO WATCHES" → On
Android Users
 • Enable Bluetooth.

Other than the above.

Some phones need to have BT Smart disabled to use the CASIO WATCHES phone app. For details about setting procedures, see your phone documentation.

On the Home Screen, tap: "Menu" → "Settings" → "Bluetooth" → "Menu" → "BT Smart settings" → "Disable".

I can't reconnect the watch and phone.

Q1 The watch will not re-connect with the phone after they are disconnected.

Is the CASIO WATCHES phone app running?

The watch cannot re-connect with the phone unless CASIO WATCHES is running on the phone. On the phone's Home Screen, tap the "CASIO WATCHES" icon. Then on the watch, hold down (B) for at least two seconds until the second hand points to [R] twice.

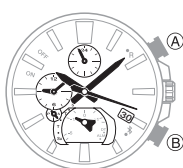

Have you tried turning your phone off and then back on again?

Turn the phone off and then back on, and then tap the "CASIO WATCHES" icon. Then on the watch, hold down (B) for at least two seconds until the second hand points to [R] twice.

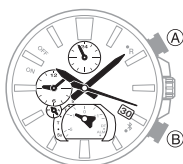

Q2 I can't connect while my phone is in the Airplane Mode.

Connection with the watch is not possible while the phone is in the Airplane Mode. After exiting the phone's Airplane Mode, go to the Home Screen and tap the "CASIO WATCHES" icon. Then on the watch, hold down (B) for at least two seconds until the second hand points to [R] twice.

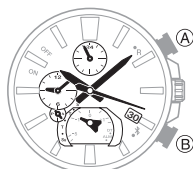

Q3 I changed the phone's Bluetooth from enabled to disabled, and now I can't connect anymore.

On the phone, turn Bluetooth off and then back on, and then tap the "CASIO WATCHES" icon on the Home Screen. Then on the watch, hold down (B) for at least two seconds until the second hand points to [R] twice.

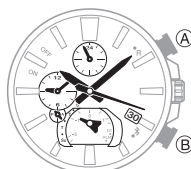

Q4 I can't connect after turning off the phone.

Turn on the phone and then tap the "CASIO WATCHES" icon. Then on the watch, hold down (B) for at least two seconds until the second hand points to [R] twice.

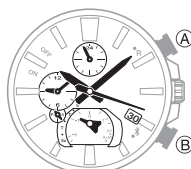

Phone-Watch Connection

Q1 I can't establish a connection between the phone and watch.

Have you tried turning your phone off and then back on again?

Turn the phone off and then back on, and then tap the "CASIO WATCHES" icon. Then on the watch, hold down (B) for at least two seconds until the second hand points to [R] twice.



Has the watch been re-paired with the phone?

After deleting pairing information from the CASIO WATCHES phone app, re-pair them.

Unpairing

If you are unable to establish a connection...

Use the procedure below to delete the pairing information from the watch, and then re-pair the watch and phone.

- ① Pull out the crown to the second click.
- ② Hold down (A) for at least five seconds until the second hand points to . This deletes the pairing information.
- ③ Push the crown back in.

Changing to a Different Phone Model

Q1 Connecting the current watch to another phone.

Pair the watch with the phone.

If you purchase another phone

Auto Time Correction by Bluetooth Connection (Time Correction)

Q1 When does the watch correct its time?

The watch will connect with the phone and perform auto time adjustment at around 12:30 a.m., 6:30 a.m., 12:30 p.m. and 6:30 p.m. The connection is automatically terminated after auto time adjustment is complete.

Q2 Auto time correction is performed, but the time setting is not correct.

Is auto time correction not being performed according to its normal schedule?

Note that auto time correction is not performed for 24 hours after swapping of the Home Time and World Time, or after the time setting is corrected manually on the watch. Auto time correction will resume 24 hours after either of the above operations is performed.

Is the watch in the Stopwatch Mode?

Time adjustment will not start if the watch is in the Stopwatch Mode when a scheduled adjustment time is reached. Exit the Stopwatch Mode.

[↻ Navigating Between Modes](#)

Is auto time adjustment enabled?

Auto time adjustment will not be performed at the scheduled times unless it is enabled. Enable auto time adjustment.

[↻ Using the Watch in a Medical Facility or Aircraft](#)

Q3 Time is not displayed correctly.

If your phone is unable to receive a signal because you are outside its service range or for some other reason, the watch may not be able to display the correct time. If this happens, connect the phone to its network and then correct the time setting.

Alarm

Q1 The alarm does not sound.

Is the watch's battery charged?

Keep the watch exposed to light until it recharges sufficiently.

[↻ Charging](#)

The crown is pulled out.

The alarm will not sound while the crown is pulled out to the second click. Push the crown back in to its normal position.

Is the alarm enabled?

Enable the alarm.

[↻ Configuring Alarm Settings](#)

Hand Movement and Indications

Q1 The second hand is jumping at two-second intervals.

Battery power is low. Keep the watch exposed to light until it recharges sufficiently.

[↻ Charging](#)

Q2 All hands are stopped and buttons do not work.

The battery is dead. Keep the watch exposed to light until it recharges sufficiently.

[↻ Charging](#)

Q3 The hands suddenly start moving at high speed.

This is due to the reason (or one of the reasons) below, and does not indicate malfunction. Simply wait until normal hand movement resumes.

- The watch is recovering from a power saving state. [↻ Power Saving](#)
- Watch is connected with a phone to correct its time setting. [↻ Auto Time Adjustment](#)

Q4 Hands are stopped and buttons do not work.

The watch is in the charge recovery mode. Wait until the recovery process is complete (for about 15 minutes). The watch will recover more quickly if you place it in a brightly lit location.

Q5 The hand and/or day indicator are not aligned correctly.

Strong magnetism or impact can cause the hands and/or the indicator to go out of alignment. Correct hand and/or day indicator alignment.

[↻ Adjusting Hand and Day Indicator Alignment](#)

- Check the information below to find out how to align the hands and/or day indicator manually.

[↻ Adjusting Hand and Day Indicator Alignment](#)

Crown Operations

Q1 Nothing happens when I rotate the crown.

If you do not perform any operation for about two minutes after pulling out the crown (approximately 30 minutes in the case of hand and day indicator alignment), crown operations will automatically become disabled. Push the crown back in to its normal position and then pull it out again to re-enable crown operations.

[↻ Using the Crown](#)

Other

Q1 I can't find the information I need here.

Visit the website below.

<https://world.casio.com/support/>