

Manualslib.com
CITIZEN[®]



Eco-Drive[®]





ManualsLib.com

中文(繁体字)

中文(简体字)

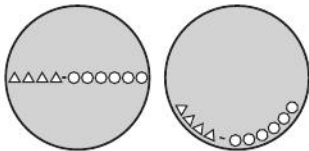
ManualsLib.com



	ManualsLib.com
	
	

	ManualsLib.com
	



ManualsLib.com





ManualsLib.com

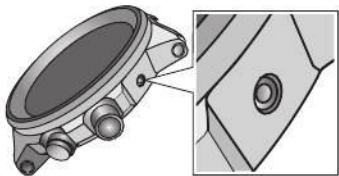
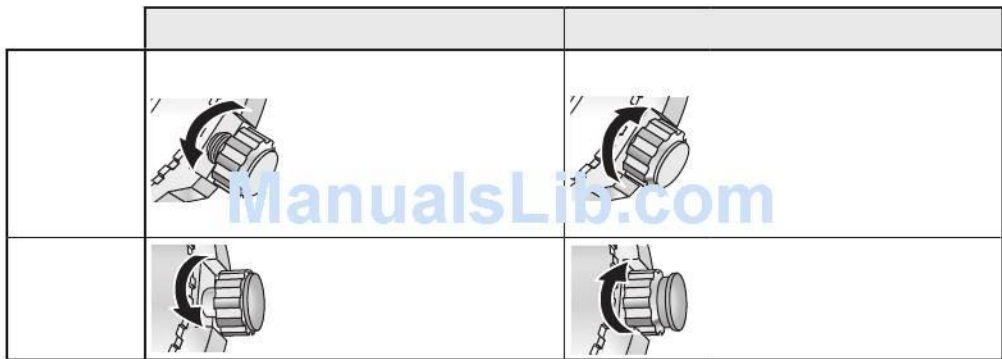



ManualsLib.com

ManualsLib.com

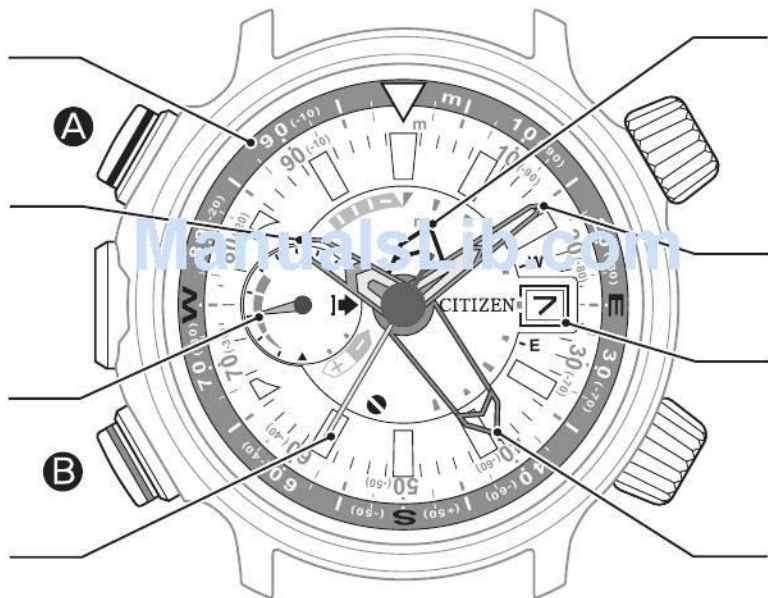

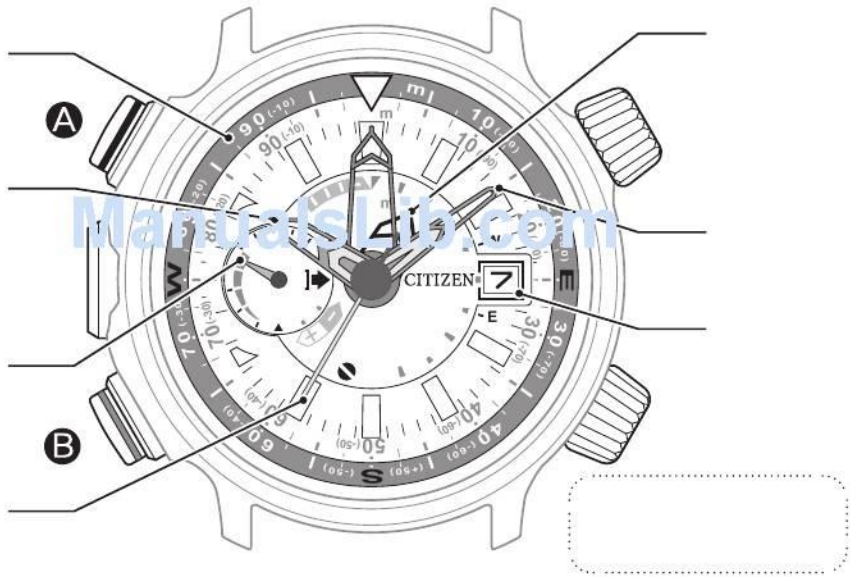

ManualsLib.com

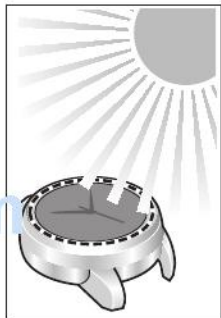

ManualsLib.com

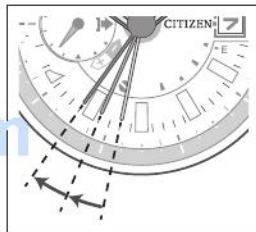

I

ManualsLib.com



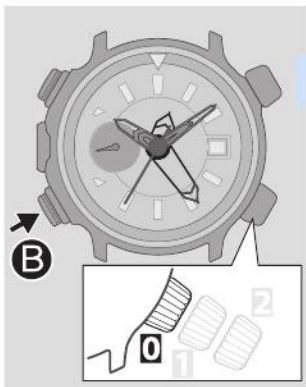

ManualsLib.com

B

A

A

B

ManualsLib.com

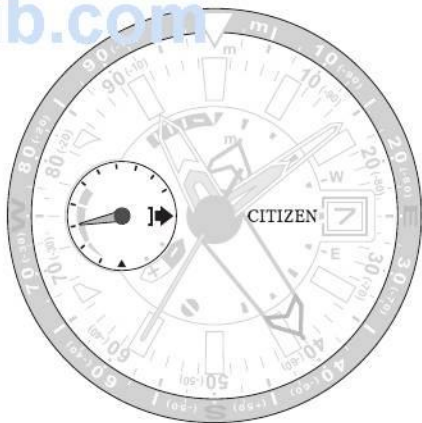

Measuring altitude

How to read altitude indication (continued)

100 m hand indication

Indication range: -300 m to 900 m

The hand points "0" when measured altitude is 0 m or higher and lower than 100 m.

On the example in the left, the measured altitude is indicated as 100 m level.

When measured altitude is lower than 0 m

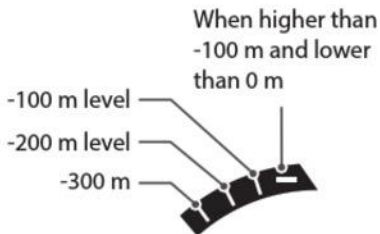

2.5 m hand indication

Indication range: -97.5 m to 97.5 m

The 100 m hand points minus indication when measured altitude is lower than 0 m. In this case, use figures in parentheses to read the 2.5 m hand.

On the example in the right, the last 2 digits of measured altitude are indicated as “40 m” or “-60 m”.

- Measured altitude is indicated in 5.0-m height when it is more than 6 000 m.
- When your watch has the scale, setting the ∇ mark on the scale to the position that the 2.5 m hand points makes it easier to determine altitude difference at the next altitude measurement.



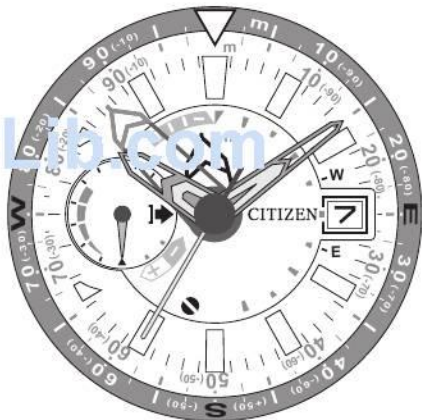
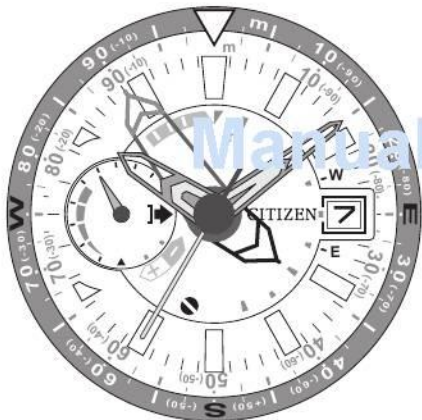

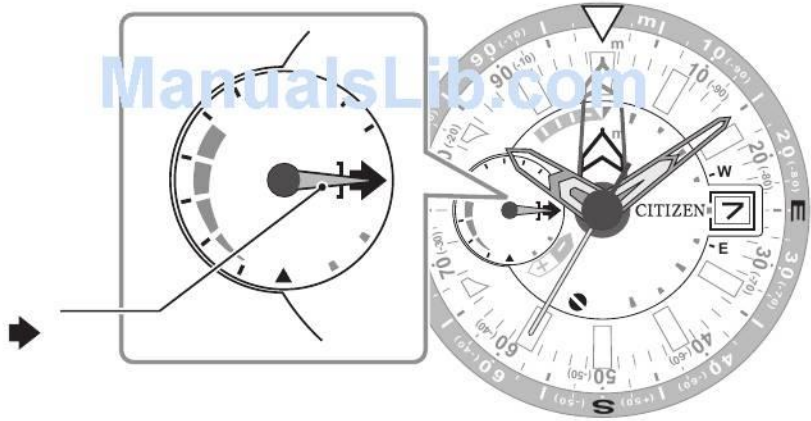

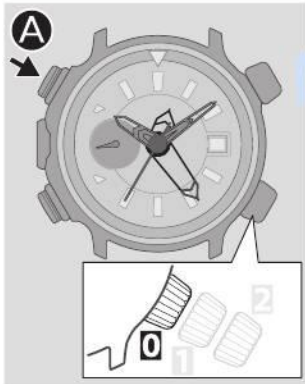

ManualsLib.com

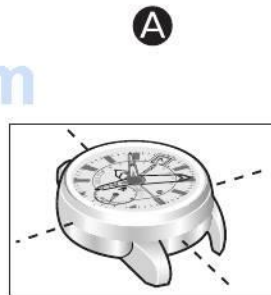

A

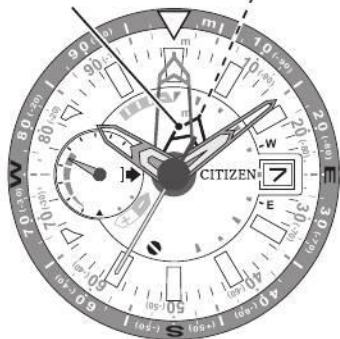

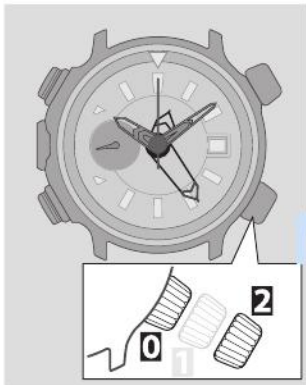

2

ManualsLib.com

0

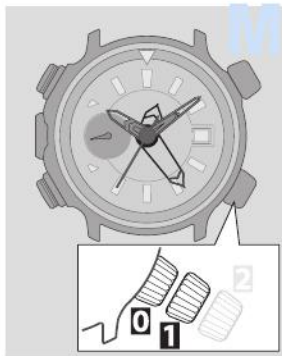

ManualsLib.com

1

0



ManualsLib.com

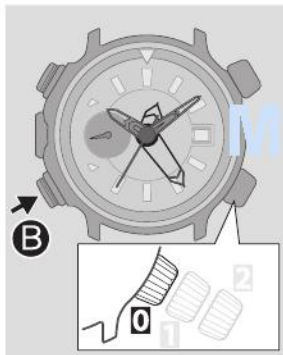

ManualsLib.com

B

B

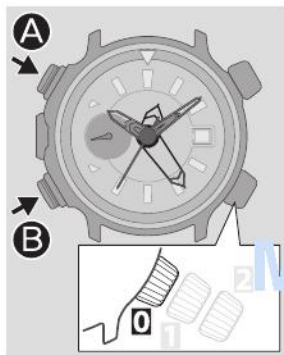

B

ManualsLib.com

A

A

B

ManualsLib.com

B

B



ManualsLib.com



ManualsLib.com

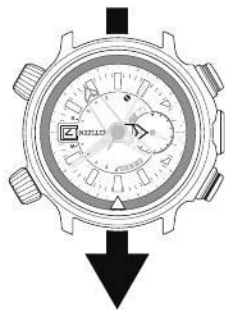
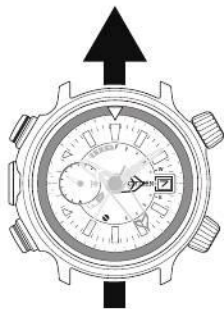

I

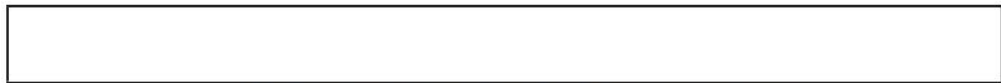

ManualsLib.com

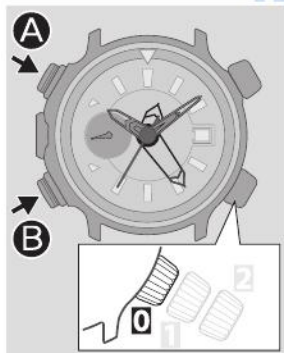

A

A



ManualsLib.com



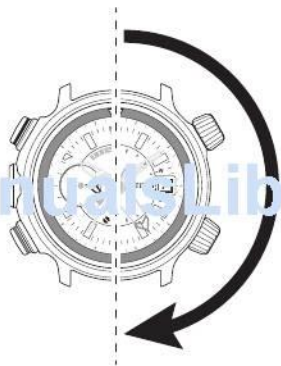
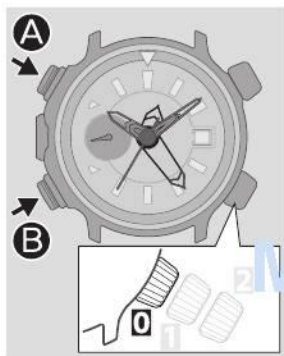

ManualsLib.com

B

A

ManualsLib.com

A

B

A

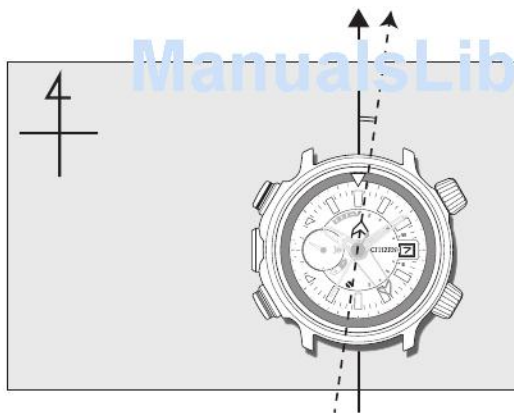

[ManualsLib.com](https://www.ManualsLib.com)

I

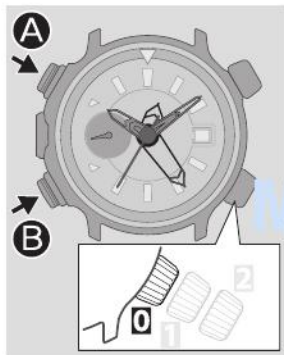

ManualsLib.com

A

A

B



A

ManualsLib.com

B

A

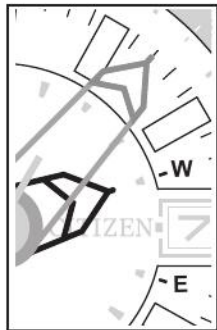

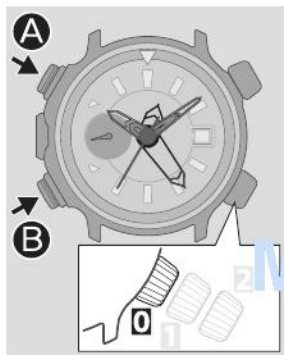

B

ManualsLib.com

A

ManualsLib.com

ManualsLib.com



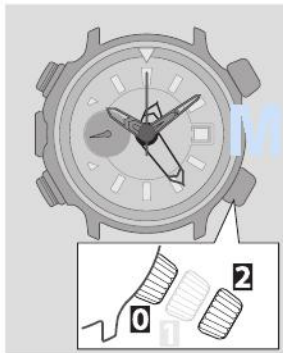

ManualsLib.com

2

0

I

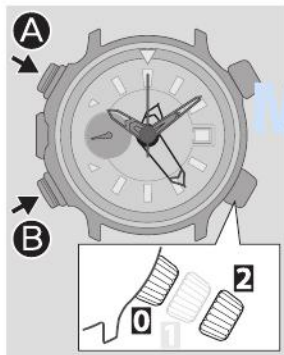

ManualsLib.com

2

B

A

B

B

ManualsLib.com

0

ManualsLib.com

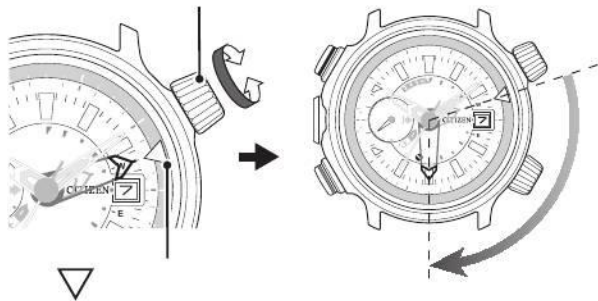

ManualsLib.com

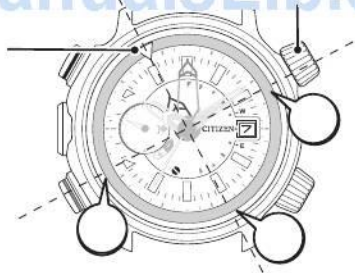



 <p>The diagram shows a watch case back on the left, which is a rectangular plate with two rectangular cutouts and a central screw. To its right is a circular watch face with a date window at the 3 o'clock position, a compass scale around the perimeter, and the brand name 'CITIZEN' at the top.</p>	<p>ManualsLib.com</p>	
---	-----------------------	--

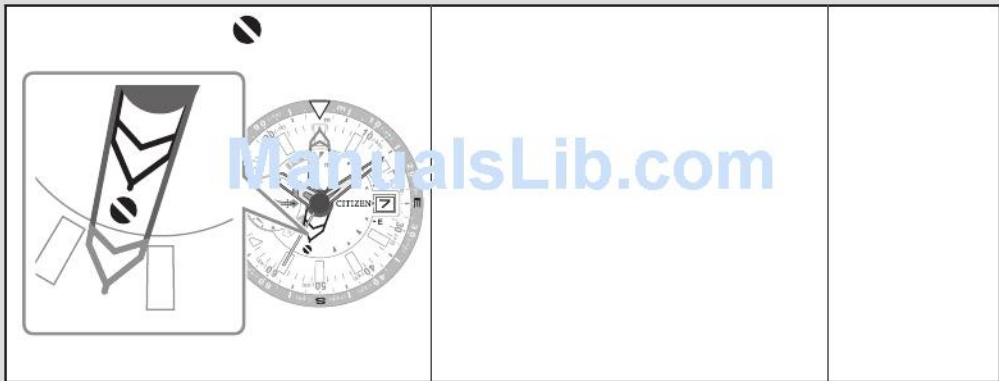

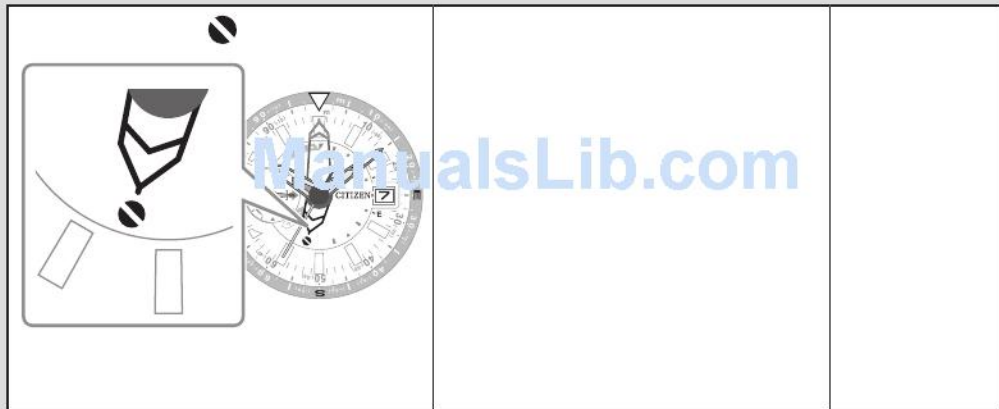

ManualsLib.com

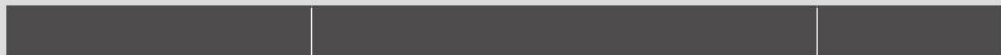

ManualsLib.com	0	
	0	

ManualsLib.com

ManualsLib.com

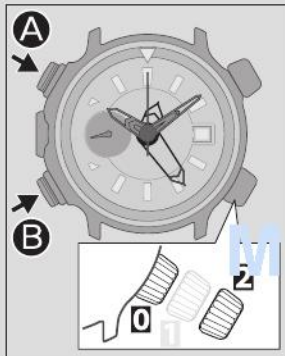

2

ManualsLib.com

B

A

ManualsLib.com



ManualsLib.com

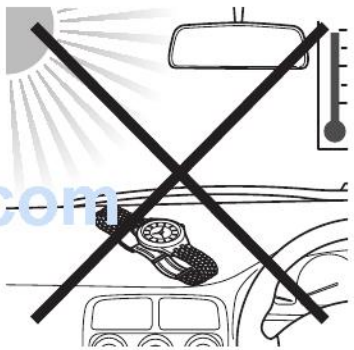

English



ManualsLib.com



ManualsLib.com



ManualsLib.com



ManualsLib.com



ManualsLib.com



ManualsLib.com



ManualsLib.com



ManualsLib.com

[ManualsLib.com](https://www.ManualsLib.com)



ManualsLib.com

ManualsLib.com





	ManualsLib.com		

ManualsLib.com





ManualsLib.com



	ManualsLib.com		

	<p>ManualsLib.com</p>
--	------------------------------

English

ManualsLib.com

CE

ManualsLib.com

BN4 *