

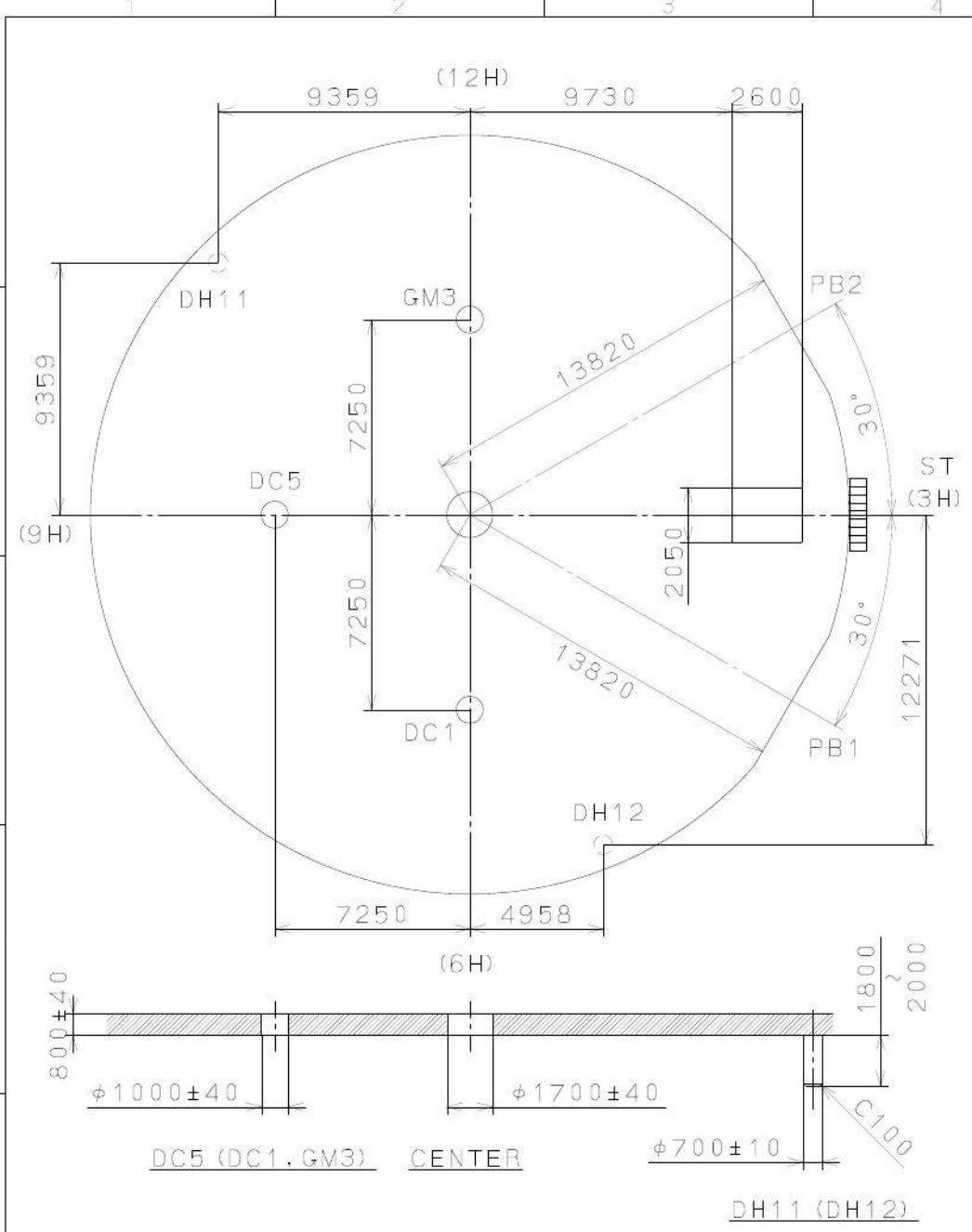



2010/02/01 (10:16:31)

This drawing is provisional and subject to our reconfirmation and/or revision without notice.



△			Quantity		Cal. NO.:
△			Unit	1/1000mm	JS16-00C
△			Scale	5:1	Parts No.:
△			Date		
△			Drawn		
Material			Checked	N. Suzuki	Name:
Heat Treatment			Approved		Indications for Dial
Hardness					Drawing No.: JS16D000
Plating			General Tolerances		<b>MIYOTA</b>
			Dimensions		
			Angles		
					CITIZEN WATCH CO., LTD., TOKYO, JAPAN

2006/12/25 (07:50:10)

This drawing is provisional and subject to our reconfirmation and/or revision without notice.

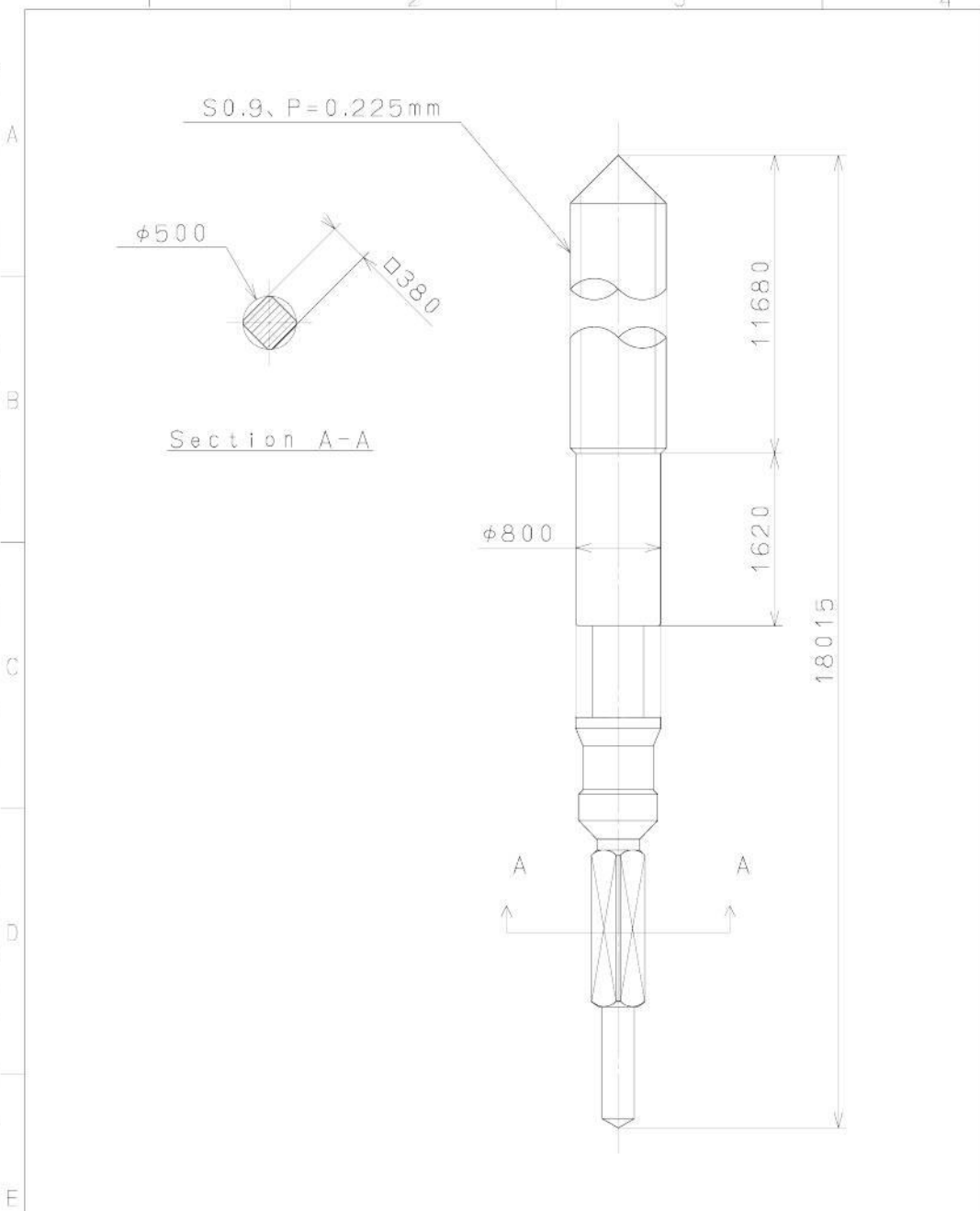

△			Quantity		Cal. NO.:
△			Unit	1/1000 <sub>mm</sub>	
△			Scale	20/1	Parts No.:
△			Date		065-505
△			Drawn		
Mark	Date	Description	Appr.	Checked	Name:
		Alterations		Approved	T. Hirata
Material					SETTING STEM
Heat Treatment					Drawing No.: 5050S000
Hardness			General Tolerances		<b>MIYOTA</b>
Plating			Dimensions		
			Angles		
					CITIZEN WATCH CO., LTD. TOKYO, JAPAN



# MIYOTA

---

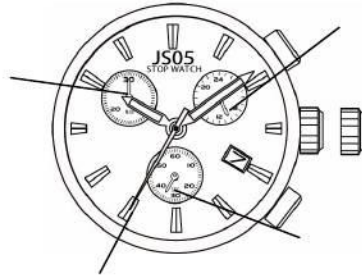
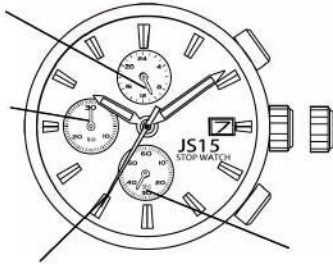
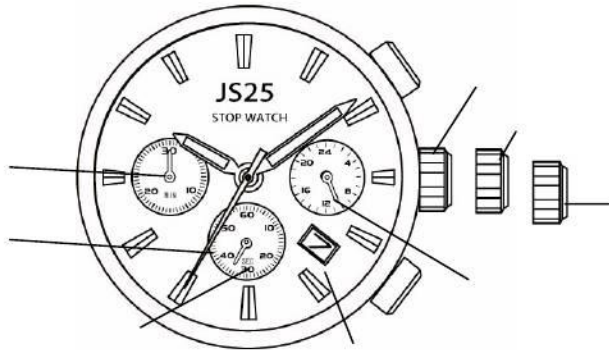



**CITIZEN WATCH CO., LTD.**

# MIYOTA

---

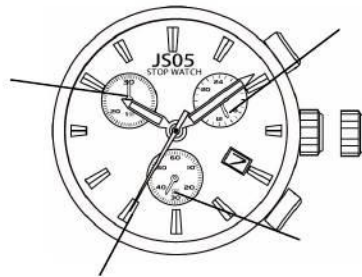
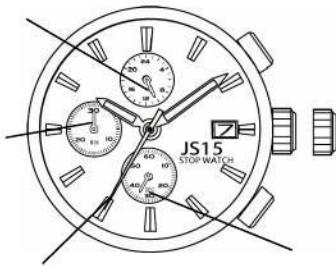
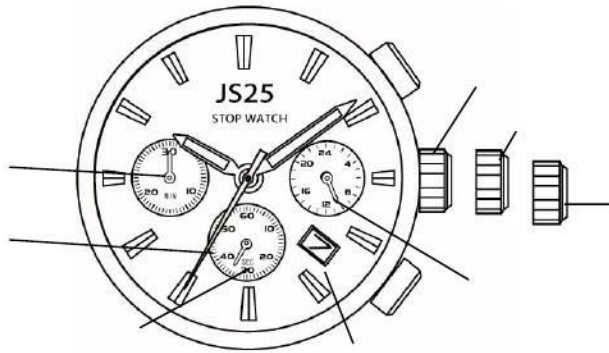

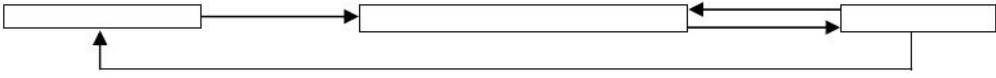

**CITIZEN WATCH CO., LTD.**

# MIYOTA

---

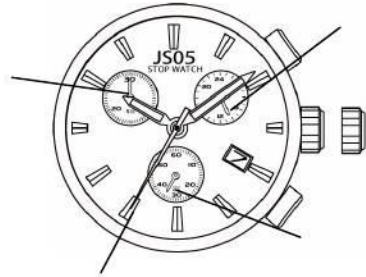
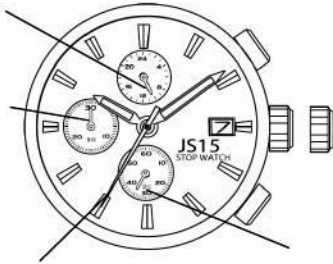
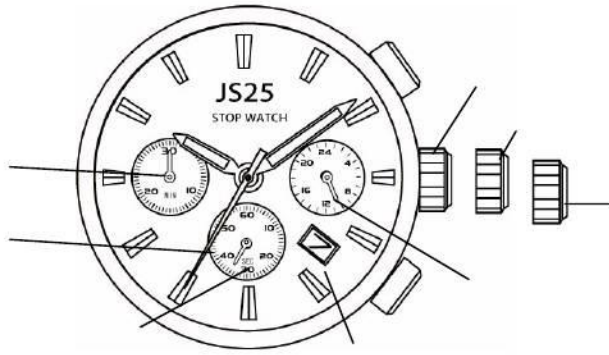

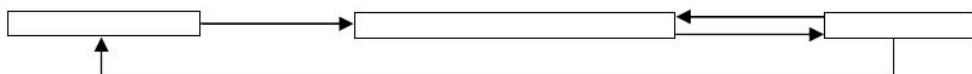

**CITIZEN WATCH CO., LTD.**

# MIYOTA

---

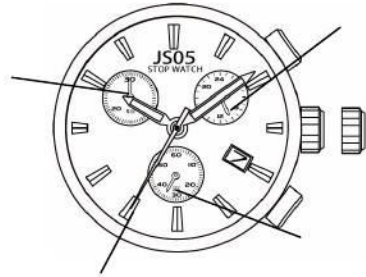
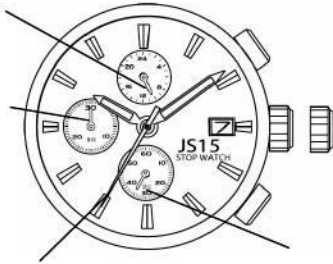
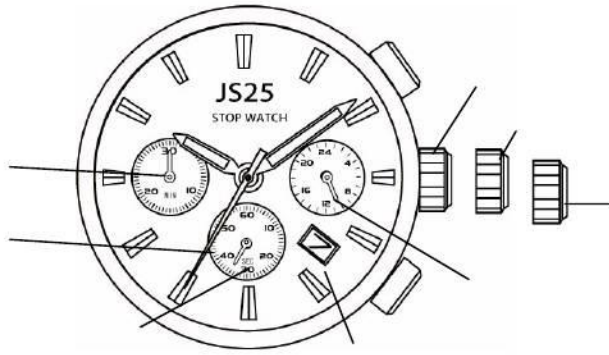

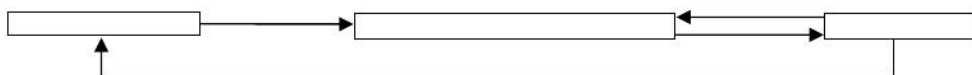

**CITIZEN WATCH CO., LTD.**

# MIYOTA

---

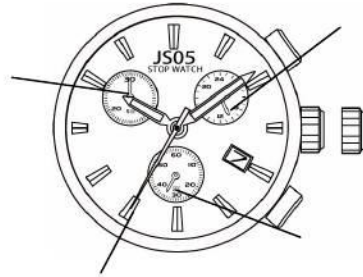
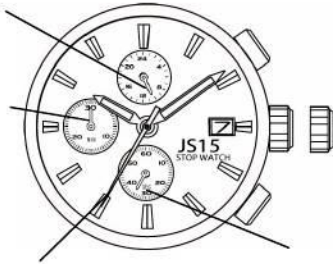
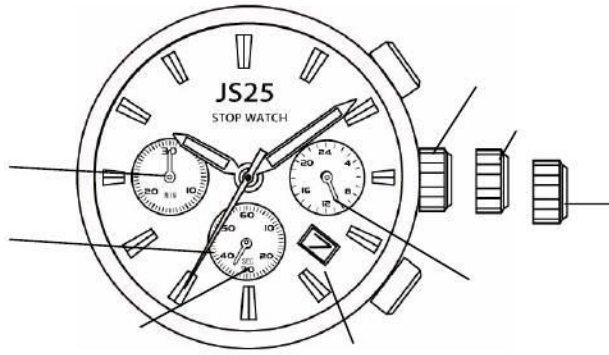

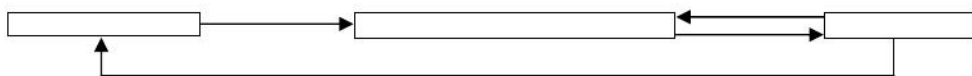

**CITIZEN WATCH CO., LTD.**

# MIYOTA

---

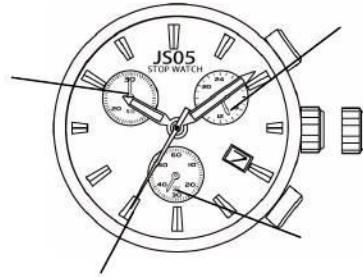
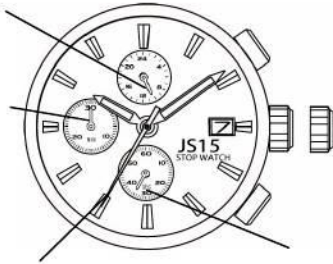
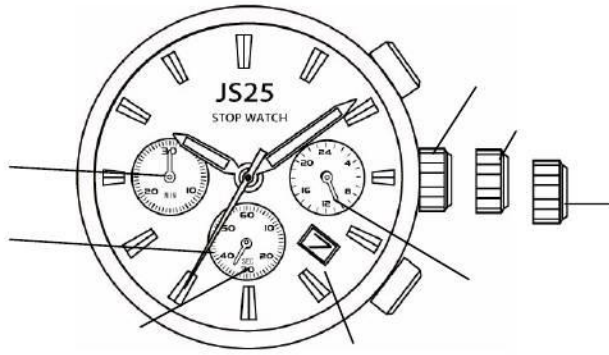

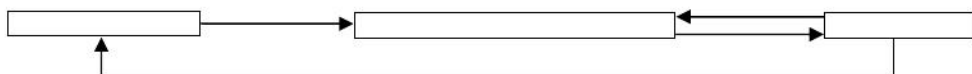

**CITIZEN WATCH CO., LTD.**

# MIYOTA

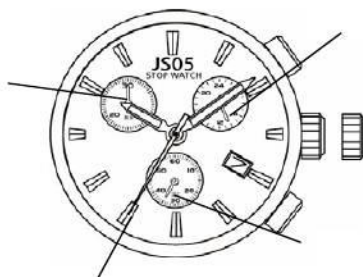
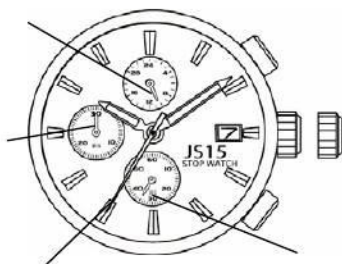
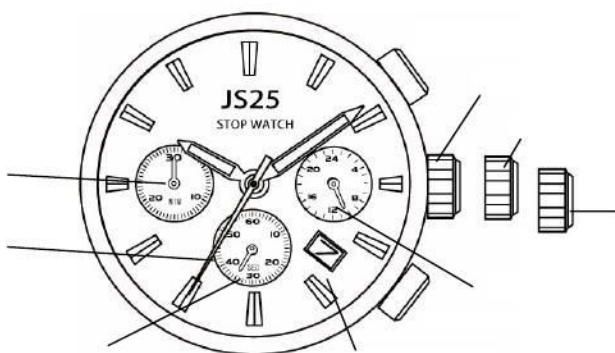

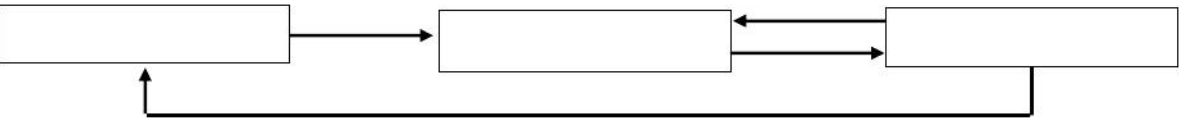

**CITIZEN WATCH CO., LTD.**

# MIYOTA

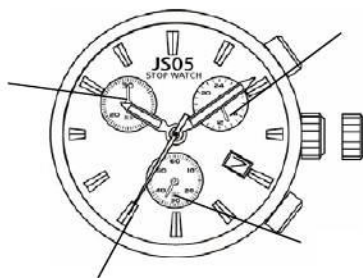
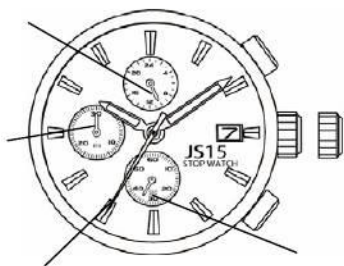
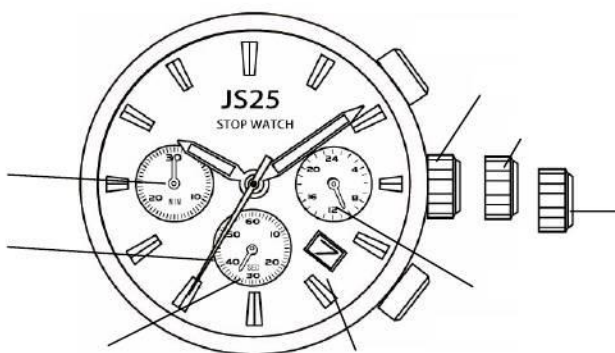

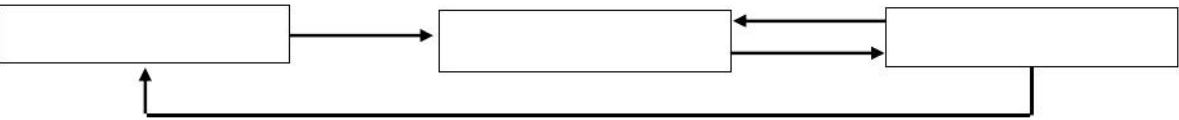

**CITIZEN WATCH CO., LTD.**