

Watch Operation Guide 5682

Contents

Precautions

Operating Precautions

User Maintenance

Battery

Before Getting Started...

General Guide

Watch Face and Display Indicators

Navigating Between Modes

Mode Overview

Using the Crown

Shifting the Hands

Charging

Viewing the Face in the Dark

Time Adjustment

Time Adjustment Using a Time Signal

Overview

Appropriate Signal Reception Location

Time Signal Reception Ranges

Auto Time Calibration Signal Receive

Enabling and disabling Auto Receive

Manual Time Calibration Signal Receive

Receive Level Indicator

Checking the Last Time Adjustment Result

Signal Reception Precautions

Using Watch Operations to Adjust the Time Setting

World Time

Checking World Time

Specifying a World Time City

Swapping Your Home Time and World Time

Alarm

Configuring Alarm Settings

Enabling the Hourly Time Signal

Turning Off an Alarm or the Hourly Time Signal

Digital Compass

Taking a Compass Reading

Calibrating Compass Readings

Calibrating Compass Readings

Setting Up for True North Readings (Magnetic Declination Calibration)

Digital Compass Reading Precautions

Altitude Measurement

Checking the Current Altitude

Calibrating Altitude Readings (Offset)

Checking the Altitude Differential from a Reference Point

Setting the Auto Measurement Interval

Recording Altitude Readings

Specifying the Altitude Measurement Unit

Altitude Reading Precautions

Barometric Pressure Measurement

Checking the Current Barometric Pressure

Checking Changes in Barometric Pressure Over Time

Checking the Change in Barometric Pressure between Two Readings

Sudden Barometric Pressure Change Indications

Calibrating Barometric Pressure Readings (Offset)

Specifying the Barometric Pressure Unit

Barometric Pressure Reading Precautions

Temperature Measurement

Checking the Current Temperature

Calibrating Temperature Readings (Offset)

Specifying the Temperature Measurement Unit

Temperature Reading Precautions

Viewing Altitude Records

Viewing Recorded Data

Deleting Data

Stopwatch

Measuring Elapsed Time

Measuring a Split Time

Timing the First and Second Place Finishers

Timer

Setting a Start Time

Using the Timer

Hand Alignment Adjustment

Adjusting Hand Alignment

Other Settings

Enabling the Button Operation Tone

Configuring Power Saving Function Settings

Other Information

City Table

Specifications

Troubleshooting

Precautions

Operating Precautions

● Water Resistance

- The information below applies to watches with WATER RESIST or WATER RESISTANT marked on the back cover.

Water Resistance Under Daily Use

Marking on watch front or on back cover	No BAR mark
-----------------------------------------	-------------

Example of Daily Use

Hand washing, rain	Yes
Water-related work, swimming	No
Windsurfing	No
Skin diving	No

Enhanced Water Resistance Under Daily Use

5 Atmospheres

Marking on watch front or on back cover	5BAR
-----------------------------------------	------

Example of Daily Use

Hand washing, rain	Yes
Water-related work, swimming	Yes
Windsurfing	No
Skin diving	No

10 Atmospheres

Marking on watch front or on back cover	10BAR
-----------------------------------------	-------

Example of Daily Use

Hand washing, rain	Yes
Water-related work, swimming	Yes
Windsurfing	Yes
Skin diving	Yes

20 Atmospheres

Marking on watch front or on back cover	20BAR
-----------------------------------------	-------

Example of Daily Use

Hand washing, rain	Yes
Water-related work, swimming	Yes
Windsurfing	Yes
Skin diving	Yes

- Do not use your watch for scuba diving or other types of diving that requires air tanks.
- Watches that do not have WATER RESIST or WATER RESISTANT marked on the back cover are not protected against the effects of sweat. Avoid using such a watch under conditions where it will be exposed to large amounts of sweat or moisture, or to direct splashing with water.
- Even if a watch is water resistant, note the usage precautions described below. Such types of use reduce water resistance performance and can cause fogging of the glass.
 - Do not operate the crown or buttons while your watch is submerged in water or wet.
 - Avoid wearing your watch while in the bath.
 - Do not wear your watch while in a heated swimming pool, sauna, or any other high temperature/high humidity environment.
 - Do not wear your watch while washing your hands or face, while doing housework, or while performing any other task that involves soaps or detergents.
- After submersion in seawater, use plain water to rinse all salt and dirt from your watch.
- To maintain water resistance, have the gaskets of your watch replaced periodically (about once every two or three years).
- A trained technician will inspect your watch for proper water resistance whenever you have its battery replaced. Battery replacement requires the use of special tools. Always request battery replacement from your original retailer or from an authorized CASIO service center.
- Some water-resistant watches come with fashionable leather bands. Avoid swimming, washing, or any other activity that causes direct exposure of a leather band to water.
- The inside surface of the watch glass may fog when the watch is exposed to a sudden drop in temperature. No problem is indicated if the fogging clears up relatively quickly. Sudden and extreme temperature changes (such as coming into an air conditioned room in the summer and standing close to an air conditioner outlet, or leaving a heated room in the winter and allowing your watch to come into contact with snow) can cause it to take longer for glass fogging to clear up. If glass fogging does not clear up or if you notice moisture inside of the glass, immediately stop using your watch and take it to your original retailer or to an authorized CASIO service center.
- Your water-resistant watch has been tested in accordance with International Organization for Standardization regulations.
- Band**
 - Tightening the band too tightly can cause you to sweat and make it difficult for air to pass under the band, which can lead to skin irritation. Do not fasten the band too tightly. There should be enough room between the band and your wrist so you can insert your finger.
 - Deterioration, rust, and other conditions can cause the band to break or come off of your watch, which in turn can cause band pins to fly out of position or to fall out. This creates the risk of your watch falling from your wrist and becoming lost, and also creates the risk of personal injury. Always take good care of your band and keep it clean.
 - Immediately stop using a band if you even notice any of the following: loss of band flexibility, band cracks, band discoloration, band looseness, band connecting pin flying or falling out, or any other abnormality. Take your watch to your original retailer or to a CASIO service center for inspection and repair (for which you will be charged) or to have the band replaced (for which you will be charged).

● Temperature

- Never leave your watch on the dashboard of a car, near a heater, or in any other location that is subject to very high temperatures. Do not leave your watch where it will be exposed to very low temperatures. Temperature extremes can cause your watch to lose or gain time, to stop, or otherwise malfunction.
- Leaving your watch in an area hotter than +60 °C (140 °F) for long periods can lead to problems with its LCD. The LCD may become difficult to read at temperatures lower than 0 °C (32 °F) and greater than +40 °C (104 °F).

● Impact

- Your watch is designed to withstand impact incurred during normal daily use and during light activity such as playing catch, tennis, etc. Dropping your watch or otherwise subjecting it to strong impact, however, can lead to malfunction. Note that watches with shock-resistant designs (G-SHOCK, BABY-G, G-MS) can be worn while operating a chain saw or engaging in other activities that generate strong vibration, or while engaging in strenuous sports activities (motocross, etc.)

● Magnetism

- The hands of analog and combination (analog-digital) watches are moved by a motor that uses magnetic force. When such a watch is close to a device (audio speakers, magnetic necklace, cell phone, etc.) that emits strong magnetism, the magnetism can cause timekeeping to slow down, speed up, or stop, resulting in the incorrect time being displayed.
- Timekeeping accuracy may be affected if the watch itself becomes magnetized. Also, very strong magnetism (from medical equipment, etc.) should be avoided because it can cause malfunction of your watch and damage to electronic components.

● Electrostatic Charge

- Exposure to very strong electrostatic charge can cause your watch to display the wrong time. Very strong electrostatic charge even can damage electronic components.
- Electrostatic charge can cause the display to go blank momentarily or cause a rainbow effect on the display.

● Chemicals

- Do not allow your watch to come into contact with thinner, gasoline, solvents, oils, or fats, or with any cleaners, adhesives, paints, medicines, or cosmetics that contain such ingredients. Doing so can cause discoloration or damage to the resin case, resin band, leather, and other parts.

● Storage

- If you do not plan to use your watch for a long time, thoroughly wipe it free of all dirt, sweat, and moisture, and store it in a cool, dry place.

● Resin Components

- Allowing your watch to remain in contact with other items or storing it together with other items for long periods while it is wet can cause color on resin components to transfer to the other items, or the color of the other items to transfer to the resin components of your watch. Be sure to dry off your watch thoroughly before storing it and make sure it is not in contact with other items.
- Leaving your watch where it is exposed to direct sunlight (ultraviolet rays) for long periods or failure to clean dirt from your watch for long periods can cause it to become discolored.
- Friction caused by certain conditions (strong external force, sustained rubbing, impact, etc.) can cause discoloration of painted components.
- If there are printed figures on the band, strong rubbing of the printed area can cause discoloration.
- Leaving your watch wet for long periods can cause fluorescent color to fade. Wipe the watch dry as soon as possible after it becomes wet.
- Semi-transparent resin parts can become discolored due to sweat and dirt, and if exposed to high temperatures and humidity for long periods.
- Daily use and long-term storage of your watch can lead to deterioration, breaking, or bending of resin components. The extent of such damage depends on usage conditions and storage conditions.

● Leather Band

- Allowing your watch to remain in contact with other items or storing it together with other items for long periods while it is wet can cause the color of the leather band to transfer to the other items or the color of the other items to transfer to the leather band. Be sure to dry off your watch thoroughly with a soft cloth before storing it and make sure it is not in contact with other items.
- Leaving a leather band where it is exposed to direct sunlight (ultraviolet rays) for long periods or failure to clean dirt from a leather band for long periods can cause it to become discolored.

CAUTION:

Exposing a leather band to rubbing or dirt can cause color transfer and discoloration.

● Metal Components

- Failure to clean dirt from metal components can lead to formation of rust, even if components are stainless steel or plated. If metal components exposed to sweat or water, wipe thoroughly with a soft, absorbent cloth and then place the watch in a well-ventilated location to dry.
- Use a soft toothbrush or similar tool to scrub the metal with a weak solution of water and a mild neutral detergent, or with soapy water. Next, rinse with water to remove all remaining detergent and then wipe dry with a soft absorbent cloth. When washing metal components, wrap the watch case with kitchen plastic wrap so it does not come into contact with the detergent or soap.

● Bacteria and Odor Resistant Band

- The bacteria and odor resistant band protects against odor generated by the formation of bacteria from sweat, which ensures comfort and hygiene. In order to ensure maximum bacteria and odor resistance, keep the band clean. Use an absorbent soft cloth to thoroughly wipe the band clean of dirt, sweat, and moisture. A bacteria and odor resistant band suppresses the formation of organisms and bacteria. It does not protect against rash due to allergic reaction, etc.

● Liquid Crystal Display

- Display figures may be difficult to read when viewed from an angle.

● Watch with Data Memory

- Allowing the battery to go dead, replacing the battery, or having your watch repaired can cause all data in watch memory to be lost. Note that CASIO Computer Co., Ltd. assumes no responsibility for any damages or losses caused by data lost due to malfunction or repair of your watch, replacement of the battery, etc. Be sure to keep separate written copies of all important data.

● Watch Sensors

- A watch sensor is a precision instrument. Never try to take it apart. Never try to insert any objects into the openings of a sensor, and take care to ensure that dirt, dust, or other foreign matter does not get into it. After using your watch where it has been immersed in saltwater, rinse it thoroughly with fresh water.

Note that CASIO Computer Co., Ltd. assumes no responsibility for any damage or loss suffered by you or any third party arising through the use of your watch or its malfunction.

User Maintenance

● Caring for Your Watch

Remember that you wear your watch next to your skin, just like a piece of clothing. To ensure your watch performs at the level for which it is designed, keep it clean by frequently wiping with a soft cloth to keep your watch and band free of dirt, sweat, water and other foreign matter.

- Whenever your watch is exposed to sea water or mud, rinse it off with clean fresh water.
- For a metal band or a resin band with metal parts, use a soft toothbrush or similar tool to scrub the band with a weak solution of water and a mild neutral detergent, or with soapy water. Next, rinse with water to remove all remaining detergent and then wipe dry with a soft absorbent cloth. When washing the band, wrap the watch case with kitchen plastic wrap so it does not come into contact with the detergent or soap.
- For a resin band, wash with water and then wipe dry with a soft cloth. Note that sometimes a smudge like pattern may appear on the surface of a resin band. This will not have any effect on your skin or clothing. Wipe with a cloth to remove the smudge pattern.
- Clean water and sweat from a leather band by wiping with a soft cloth.
- Not operating a watch crown, buttons, or rotary bezel could lead to later problems with their operation. Periodically rotate the crown and rotary bezel, and press buttons to maintain proper operation.

● Dangers of Poor Watch Care

Rust

- Though the metal steel used for your watch is highly rust-resistant, rust can form if your watch is not cleaned after it becomes dirty.
 - Dirt on your watch can make it impossible for oxygen to come into contact with the metal, which can lead to breakdown of the oxidization layer on the metal surface and the formation of rust.
- Rust can cause sharp areas on metal components and can cause band pins to fly out of position or to fall out. If you ever notice any abnormality immediately stop using your watch and take it to your original retailer or to an authorized CASIO service center.
- Even if the surface of the metal appears clean, sweat and rust in crevasses can soil the sleeves of clothing, cause skin irritation, and even interfere with watch performance.

Premature Wear

- Leaving sweat or water on a resin band or bezel, or storing your watch in an area subject to high moisture can lead to premature wear, cuts, and breaks.

Skin Irritation

- Individuals with sensitive skin or in poor physical condition may experience skin irritation when wearing a watch. Such individuals should keep their leather band or resin band particularly clean. Should you ever experience a rash or other skin irritation, immediately remove your watch and contact a skin care professional.

Battery

- The special rechargeable battery used by your watch is not intended to be removed or replaced by you. Use of a rechargeable battery other than the special one specified for your watch can damage your watch.
- The rechargeable (secondary) battery is charged when the solar panel is exposed to light, so it does not require regular replacement as the primary battery requires. Note, however, that long use or operating conditions can cause the capacity or charging efficiency of the rechargeable battery to deteriorate. If you feel that the amount of operation provided by charging is too short, contact your original retailer or CASIO service center.

Before Getting Started...

This section provides an overview of the watch and introduces convenient ways it can be used.

● Watch Features

• Solar Charging

Sunlight and artificial light generate electricity for watch operation as it charges.

• Time Signal Reception

The watch receives a radio signal containing time information and uses it to keep its time setting accurate.

• World Time

You can display the current time in any one of 29 cities around the globe, as well as for UTC (Coordinated Universal Time).

• Alarm

An alarm sounds whenever a time specified by you is reached.

• Digital Compass

You can use the Compass Mode to determine the direction of north, and to check your bearing to a destination.

• Altitude Measurement

You can use this function to take an altitude reading at your current location. You can record the altitude, along with the date and time of the measurement. You can also measure the altitude differential between two points.

• Barometric Pressure Measurement

You can display the current barometric pressure tendency, which helps you be on the alert for noteworthy pressure changes.

• Temperature Measurement

The watch can be used to take current air temperature readings.

• Viewing Altitude Records

You can view or delete records of altitude measurements.

• Stopwatch

You can use the stopwatch to measure up to 24 hours of elapsed time in units of 1/100 of a second.

• Timer

Countdown from a start time specified by you. An alarm sounds when the countdown reaches zero.

Important!

- This watch is not a special-purpose measuring instrument. Measurement function readings are intended for general reference only.
- Whenever using the Digital Compass of this watch for serious trekking, mountain climbing, or other activities, be sure to always take along another compass to confirm readings. If the readings produced by the Digital Compass of this watch are different from those of the other compass, perform 2-point calibration of the Digital Compass to ensure better accuracy.
 - Compass readings and calibration will not be possible if the watch is in the vicinity of a permanent magnet (magnetic accessory, etc.), metal objects, high-voltage wires, aerial wires, or electrical household appliances (TV, computer, cellphone, etc.)

Digital Compass

- The watch's altimeter function calculates and displays relative altitude based on barometric pressure readings produced by its pressure sensor. Because of this, altitude values displayed by the watch may be different from your actual elevation and/or sea level elevation indicated for the area where you are located. Regular calibration in accordance with the local altitude (elevation) indications is recommended.

Altitude Measurement

Note

- The illustrations included in this operation guide have been created to facilitate explanation. An illustration may differ somewhat from the item it represents.

General Guide

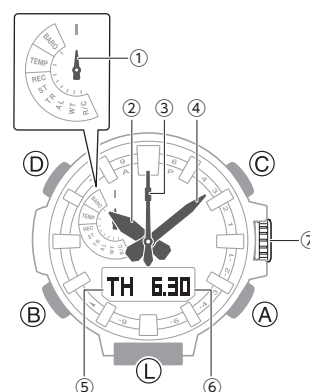

- ① Mode hand
- ② Hour hand
- ③ Second hand
- ④ Minute hand
- ⑤ Day of the week
- ⑥ Month, day
- ⑦ Crown

A button

Pressing this button in the Timekeeping Mode enters the Altimeter Mode.

B button

Each press cycles between watch modes.

In any mode, hold down this button for at least two seconds to return to the Timekeeping Mode.

C button

Pressing this button in the Timekeeping Mode enters the Compass Mode.

D button

Pressing this button in the Timekeeping Mode cycles between displays.

L button

Press to turn on illumination.

Watch Face and Display Indicators

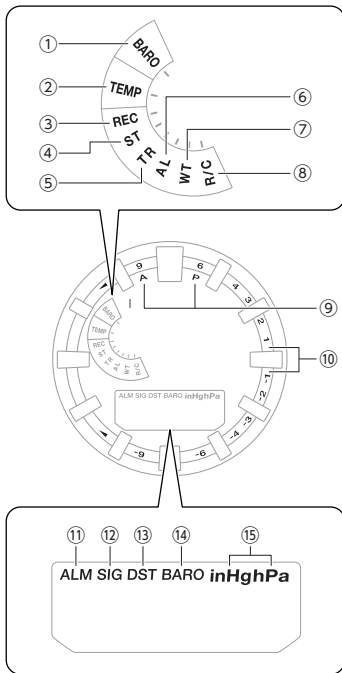

- ① In the Barometer Mode, the mode hand points to [BARO].
- ② In the Thermometer Mode, the mode hand points to [TEMP].
- ③ In the Altitude Record Recall Mode, the mode hand points to [REC].
- ④ In the Stopwatch Mode, the mode hand points to [ST].
- ⑤ In the Timer Mode, the mode hand points to [TR].
- ⑥ In the Alarm Mode, the mode hand points to [AL].
- ⑦ In the World Time Mode, the mode hand points to [WT].
- ⑧ In the Receive Mode, the mode hand points to [R/C].

- ⑨ During 12-hour timekeeping, the second hand points to [A] for a.m. times and [P] for p.m. times
- ⑩ The second hand indicates altitude/ barometric pressure differential.
- ⑪ Displayed when an alarm is turned on.
- ⑫ Appears when the hourly time signal is on.
- ⑬ Displayed when the indicated time is summer time.
- ⑭ Displayed while barometric pressure change indication is enabled.
- ⑮ Shows the barometric pressure measurement unit.

Navigating Between Modes

Your watch has the modes shown below.

- To return to the Timekeeping Mode from any other mode, hold down (B) for at least two seconds.

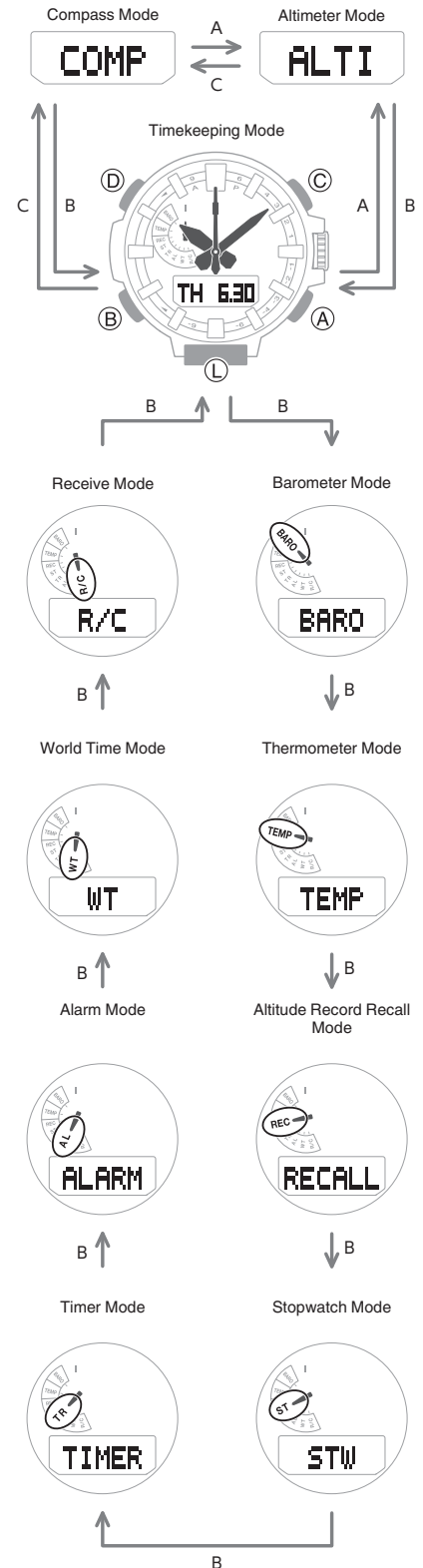

Use the buttons in the illustration above to navigate between modes.

Mode Overview

● Timekeeping Mode

In this mode, the digital display shows the current day of the week, month, and day. You can also use (D) to scroll display contents through the items below.

- Barometric pressure graph, month, day
- Hour, minute, second

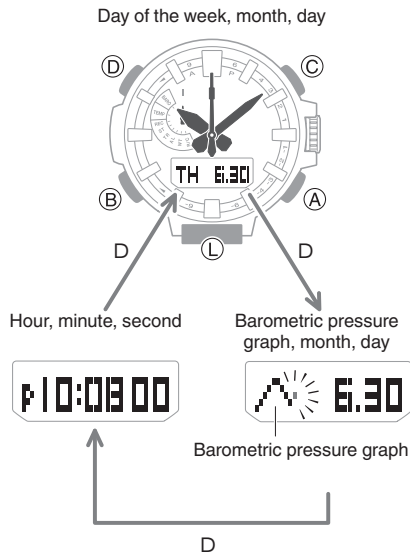

● Altimeter Mode

Use this mode to take an altitude reading for your current location.

🔍 Altitude Measurement

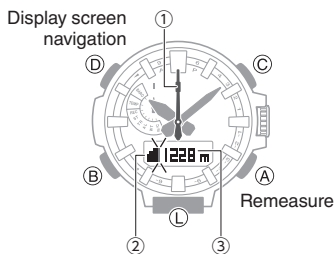

- ① Altitude differential/current time seconds
- ② Altitude graph
- ③ Altitude

● Compass Mode

Use this mode to take direction and bearing angle readings.

🔍 Digital Compass

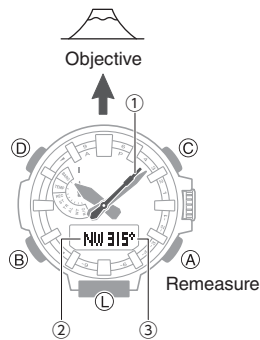

- ① North indication
- ② Bearing at 12 o'clock
- ③ Bearing angle at 12 o'clock

● Barometer Mode

Use this mode to take barometric pressure readings at your current location.

🔍 Barometric Pressure Measurement

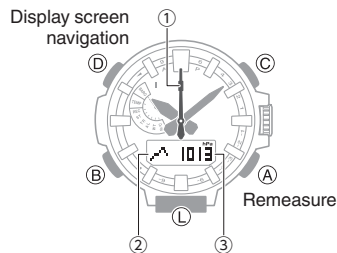

- ① Barometric pressure differential/current time seconds
- ② Barometric pressure graph
- ③ Barometric pressure

● Thermometer Mode

Use this mode to take temperature readings at your current location.

🔍 Temperature Measurement

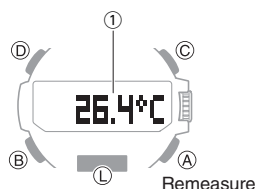

- ① Temperature

● Altitude Record Recall Mode

Use this mode to view altitude records.

🔍 Viewing Altitude Records

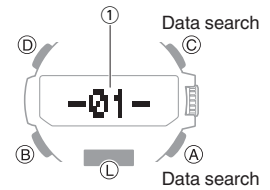

- ① Number of the record displayed last time the Altitude Record Recall Mode was used

● Stopwatch Mode

Use this mode to measure elapsed time.

🔍 Stopwatch

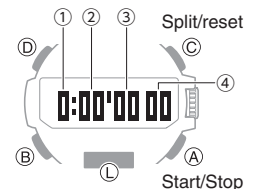

- ① Stopwatch hours
- ② Stopwatch minutes
- ③ Stopwatch seconds
- ④ Stopwatch: 1/100 second

● Timer Mode

Use this mode to countdown from a desired start time.

🔍 Timer

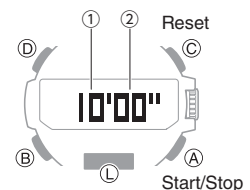

- ① Timer minutes
- ② Timer seconds

● Alarm Mode

The watch will beep when an alarm time is reached.

🕒 Alarm

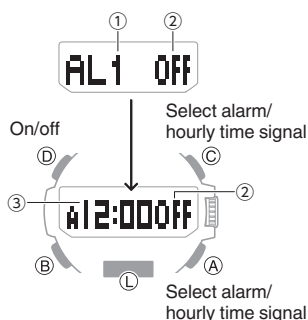

- ① Alarm number
- ② Alarm or hourly time signal status (on/off)
- ③ Alarm hour/minute

● World Time Mode

You can view the current time in 29 cities and UTC (Coordinated Universal Time) time.

🕒 World Time

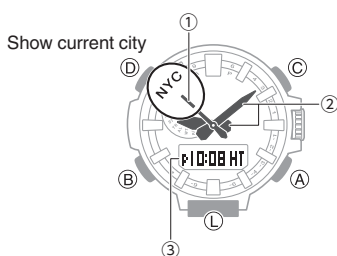

- ① City Codes (World Time Codes)
- ② World Time City current time
- ③ Home City time

● Receive Mode

With this mode, you can receive a time signal manually.

🕒 Time Adjustment Using a Time Signal



- ① Receive level indicator

Using the Crown

The watch's crown is a screw-in (screw lock) type. To use the crown, you first need to rotate it towards you (leftwards) to loosen it.

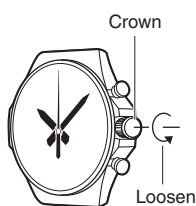

Important!

- To prevent loss of water resistance and/or damage due to impact, be sure to screw the crown in by rotating it away from you as you push it in.

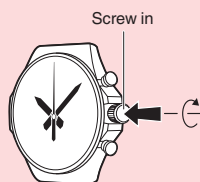

- When pushing the crown back in, take care not to apply too much force.

● Fast Forward/Fast Reverse

After pulling out the crown, rotating it quickly in succession in either direction will start a fast forward or fast reverse operation. While a fast forward operation is in progress, quickly rotating the crown in succession again will increase the speed even further.

● Stopping Fast Forward/Fast Reverse

Rotate the crown in the direction opposite that of the ongoing operation or press any button.

Note

- If you do not perform any operation for about two minutes after pulling out the crown, crown operations will automatically become disabled. If that happens, push the crown back in and then pull it out again.

Shifting the Hands

Hand shift moves the hands out of the way for easy viewing of display information.

1. While holding down (L), press (B).

This will shift the analog hands to allow easy viewing of display information.

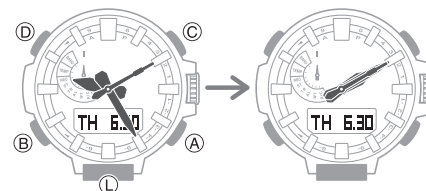

2. To return the hands to their normal timekeeping positions, press (A), (B), (C), or (D).

Note

- If you leave the watch with its hands shifted and do not perform any operation for about ten seconds, the hands resume normal timekeeping automatically.

Charging

This watch runs on power supplied from a rechargeable (secondary) battery that is charged by a solar panel. The solar panel is integrated into the face of the watch, and power is generated whenever the face is exposed to light.

● Charging the Watch

When you are not wearing the watch, put it in a location where it is exposed to bright light.



While you are wearing the watch, make sure that its face (solar panel) is not blocked from light by the sleeve of your clothing. Power generation efficiency is reduced even when the face of the watch is blocked only partially.

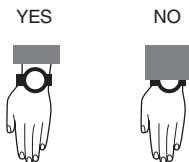

Important!

- Some light sources and environments can cause the watch to become extremely hot during charging, which creates the risk of burn injury and damage to internal watch components. Avoid charging the watch under conditions like the ones described below, where the temperatures may exceed 60 °C (140 °F).
 - On the dashboard of a vehicle parked in the sun
 - Near incandescent lamps, camera lights, halogen lamps, or other sources of heat
 - In locations exposed to direct sunlight for long periods and other hot locations
- The display panel may become black (or white, depending on the LCD type) under very high temperatures. This is temporary, and the display will return to normal at lower temperatures.

● Checking the Charge Level

A display indicator shows the watch's charge level when you enter the Timekeeping Mode.

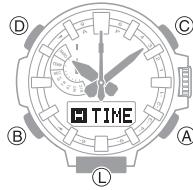

- The display will show charge levels 4 and 5, even if the watch is not in the Timekeeping Mode.

Charge Level 1: Good

All functions enabled.



Charge Level 2: Good

All functions enabled.



Charge Level 3: Low

The functions below are disabled. Also, the second hand jumps at two-second intervals.

- Time signal reception
- Compass, altitude, barometric pressure, temperature measurements
- Face illumination
- Sounds (alarms, etc.)



↓ One second later



Charge Level 4: Low

Battery charge is lower than Level 3, and all functions are disabled. Also, all hands are stopped.

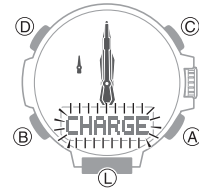

Charge Level 5: Dead

All hands are stopped and digital displays are blank. Memory data is lost, and watch settings are returned to their initial factory defaults.

Important!

- Should the battery go low or go dead, expose the face (solar panel) to light as soon as possible.

Note

- If [RECOVER] is flashing on the display, it means that all functions are disabled due to momentary battery power consumption.
- Exposing the watch face to light after the battery goes dead causes the [CHARGE] indicator to appear. This indicates charging has started.

● Charging Time Guidelines

The table below shows guidelines for approximate charging times.

Charging Times Required for 1 Day of Operation

Light Level (Lux)	Approximate Charging Time
50,000	8 minutes
10,000	30 minutes
5,000	48 minutes
500	8 hours

Charge Recovery Times

- Sunny day, outdoors (50,000 lux)

Dead battery → Medium charge	3 hours
Medium charge → High charge	22 hours
High charge → Full charge	6 hours

- Sunny day, near a window (10,000 lux)

Dead battery → Medium charge	7 hours
Medium charge → High charge	84 hours
High charge → Full charge	23 hours

- Overcast day, near a window (5,000 lux)

Dead battery → Medium charge	10 hours
Medium charge → High charge	136 hours
High charge → Full charge	37 hours

- Indoor fluorescent lighting (500 lux)

Dead battery → Medium charge	119 hours
Medium charge → High charge	-
High charge → Full charge	-

Note

- Actual charging time depends on the charging environment, watch settings, and other factors.

● Power Saving Function

Leaving the watch in a dark location for about one hour between the hours of 10 p.m. and 6 a.m. will cause the display to go blank, and the watch to enter Level 1 power saving. If the watch is left in this condition for six or seven days, the watch will enter Level 2 power saving.

Power Saving Level 1 :

The second hand stops at 12 o'clock and the digital display goes blank to save power.

Power Saving Level 2 :

All hands stop and the digital display goes blank to save power. All functions are disabled.

Recovering from Power Saving Operation

Use one of the operations below to exit power saving.

- Press any button.
- Move the watch to a bright location.
- Trigger auto light by angling the watch towards your face.

Note

- The watch will not enter power saving in the cases below.
 - While in the Stopwatch Mode
 - While in the Timer Mode
 - While the barometric pressure change indicator is displayed
- You can enable or disable Power Saving.
 - 🔍 [Configuring Power Saving Function Settings](#)
- Note that the watch also may enter power saving if its face is blocked from light by your sleeve while you are wearing it.

Viewing the Face in the Dark

The face of the watch can be illuminated for viewing in the dark.

● To illuminate the face manually

Pressing (L) turns on illumination.

- Illumination turns off automatically if an alarm starts to sound or if you perform a crown operation.
- Illumination does not turn on while a signal receive operation or a hand movement operation is in progress. Also, illumination may not turn on while a sensor is taking a reading.

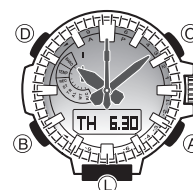

● To illuminate the face when Auto Light is enabled

If Auto Light is enabled, face illumination will turn on automatically whenever the watch is positioned at an angle of 40 degrees or more.

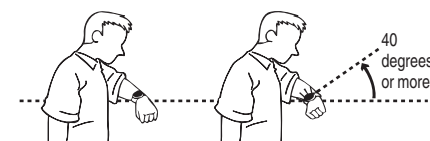

Important!

- Auto Light may not operate properly when the watch is at a horizontal angle of 15 degrees or greater from horizontal as shown in the illustration below.



- Electro-static charge or magnetism can interfere with proper auto light operation. If this happens, try lowering your arm and then angle it towards your face again.
- When moving the watch you may note a slight rattling sound. This is due to operation of the auto light switch, which determines the current orientation of the watch. It does not indicate malfunction.

Note

- Auto Light is disabled when any one of the conditions below exists.
 - Alarm, timer alert, or other beeper sounding
 - Hand movement operation is in progress
 - Watch in the Compass Mode
 - While a time signal receive operation is in progress

● Configuring the Auto Light Setting

You can enable or disable Auto Light as required.

1. Enter the Timekeeping Mode.
[🔍 Navigating Between Modes](#)

2. Pull out the crown.

This causes [CITY] to flash on the display and the second hand to move to the current Home City.

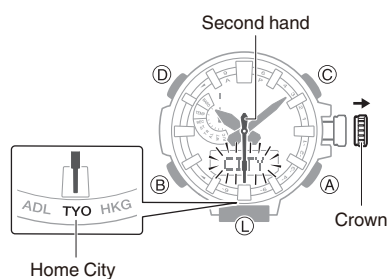

3. Press (B) three times.

[**AUTO**] appears on the display with [ON] or [OFF] flashing.

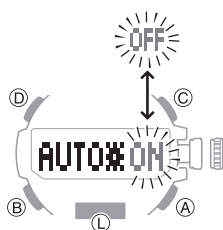

4. Rotate the crown to enable or disable the Auto Light.

5. Push the crown back in to complete the setting operation.

Note

- If you do not perform any operation for about two minutes after pulling out the crown, crown operations will automatically become disabled. If that happens, push the crown back in and then pull it out again.

● Specifying the Illumination Duration

You can select either 1.5 seconds or three seconds as the illumination duration.

1. Enter the Timekeeping Mode.
[🔍 Navigating Between Modes](#)

2. Pull out the crown.

This causes [CITY] to flash on the display and the second hand to move to the current Home City.

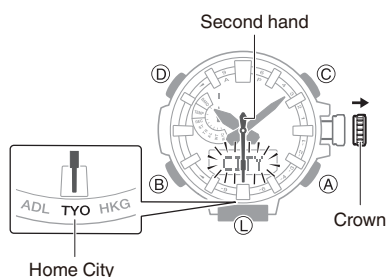

3. Press (B) four times.

[LIGHT] appears on the display with [1] or [3] flashing.

4. Rotate the crown to select an illumination duration.

[1]: 1.5-second illumination

[3]: 3-second illumination

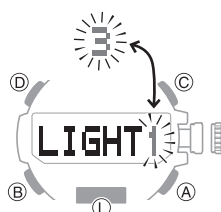

5. Push the crown back in to complete the setting operation.

Note

- If you do not perform any operation for about two minutes after pulling out the crown, crown operations will automatically become disabled. If that happens, push the crown back in and then pull it out again.

Time Adjustment

Your watch can receive time calibration signals and adjust its date and time setting.

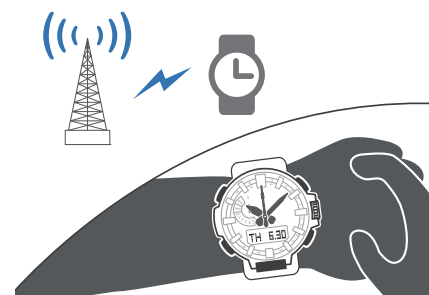

Time Adjustment Using a Time Signal

Overview

The watch's time and day settings can be configured in accordance with a received time calibration signal.

Important!

- In order to make it possible for the current time setting to be adjusted correctly based on time calibration signal reception, you need to specify the area where you are using the watch.

[🔍 Setting a Home City](#)

Note

- Areas where time signal reception is supported are limited. When you are using the watch in an area where time calibration signal reception is not possible, adjust time and day settings manually.

[🔍 Using Watch Operations to Adjust the Time Setting](#)

Appropriate Signal Reception Location

A time calibration signal can be received while the watch is near a window.

- Position the watch so its 12 o'clock side is facing the window.
- Keep metal objects away from the watch.
- Do not move the watch.
- Do not perform any operation on the watch.

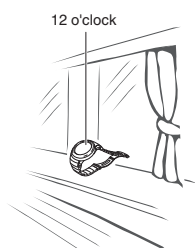

Note

- You may experience time calibration reception problems in the areas described below.
 - Among or near buildings
 - While riding in a vehicle
 - Near household appliances, office machines, mobile phones, etc.
 - On a construction site, in an airport, or any other location where radio wave interference occurs
 - Near high-voltage lines
 - In mountainous areas or behind a mountain

Time Signal Reception Ranges

● Japan (JJY)

The Japan time signal radio stations are located on Mt. Otakadoya in Fukushima and Mt. Hagane in Fukuoka/Saga.

The reception range of the Japanese time signals is approximately 1,000 km from each transmission station.

● China (BPC)

The China time signal radio station is located in Shangqiu, Henan Province, China.

The reception range of the Chinese time signal is approximately 1,500 km from the transmission station.

● United States (WWVB)

The United States time signal radio station is located in Fort Collins, Colorado.

The reception range of the U.S. time signal is approximately 3,000 km from the transmission station.

● U.K. (MSF)/Germany (DCF77)

The U.K. time signal radio station is located in Anthorn, Cumbria.

The German time signal radio station is located in Mainflingen, southeast of Frankfurt. The reception range of the U.K. and German time signals is approximately 1,500 km from each transmission station.

Note

- Even if you are within the normal reception range of a time calibration signal, reception may be made impossible by the following factors: geographic contours, weather, the season, the time of day, wireless noise.
- A time calibration signal cannot be received while the city selected as your Home City is one that does not support signal reception.

Auto Time Calibration Signal Receive

An automatic time calibration signal receive operation is performed and the time and day settings are adjusted between midnight and 5:00 a.m. Once a signal receive operation is successful, no more auto receive operations are performed that day.

1. Place the watch near a window or some other location appropriate for signal reception.
 - [RC !] is shown on the display while time signal reception is in progress.
 - When a receive operation is successful, the watch adjusts its current time and day settings automatically, and then returns to the Timekeeping Mode.

Note

- Reception takes anywhere from about two minutes to about 10 minutes. It can take as long as 20 minutes.

Enabling and disabling Auto Receive

You can stop auto receive by disabling the Auto Receive setting.

Note

- While the Home City setting is one where time signal reception is possible, you can enable or disable auto receive as required.
 - 🔗 [Time Signal Reception Ranges](#)

1. Enter the Receive Mode.
 - 🔗 [Navigating Between Modes](#)
2. Pull out the crown.

[AUTORC] appears on the display with [ON] or [OFF] flashing.

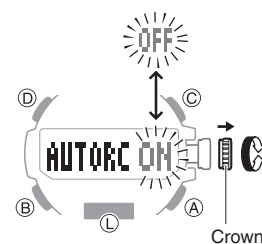

3. Rotate the crown to enable or disable Auto Receive.
4. Push the crown back in to complete the setting operation.

Note

- If you do not perform any operation for about three minutes while performing the Auto Receive on/off operation, the watch automatically returns to the Timekeeping Mode.
- If you do not perform any operation for about two minutes after pulling out the crown, crown operations will automatically become disabled. If that happens, push the crown back in and then pull it out again.

Manual Time Calibration Signal Receive

1. Place the watch near a window or some other location appropriate for time signal reception.
2. Enter the Receive Mode.
[🔍 Navigating Between Modes](#)
3. Hold down (A) for at least two seconds until [RC !] appears on the display.

This indicates that the receive operation has started. After the receive operation is complete, the watch's time and day settings will be adjusted accordingly.

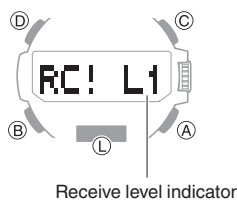

Receive level indicator

- The level indicator shows the signal level ([L1], [L2], [L3]) while a receive operation is in progress.
[🔍 Receive Level Indicator](#)

Note

- The receive operation takes anywhere from about two minutes to about 10 minutes. It can take as long as 20 minutes.
- Time calibration signal reception is better at night than during the day.

Receive Level Indicator

While a receive operation is in progress, its current status is indicated on the display as shown below. Use the level indicator to find a location where signal reception is stable.

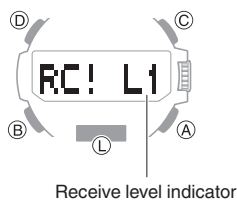

Receive level indicator

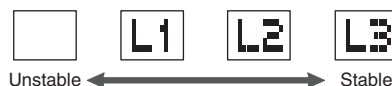

Note

- It takes about 10 seconds for time signal reception conditions to stabilize.
- Reception conditions are affected by weather, the time of day, the surrounding environment, etc.

Checking the Last Time Adjustment Result

1. Enter the Receive Mode.
[🔍 Navigating Between Modes](#)

This displays the date and time of the last successful receive operation.

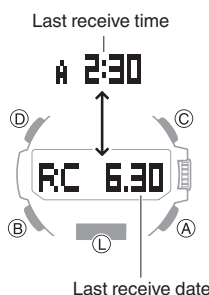

Last receive date

Signal Reception Precautions

- When the watch is unable to adjust its time in accordance with a calibration signal for some reason, average timekeeping accuracy is within ± 15 seconds per month.
- Note that an internal decoding process the watch performs after it receives a signal may cause the time setting to be slightly off (by less than one second).
- Time calibration signal reception is not possible under the conditions described below.
 - While battery power is low
 - In any mode besides the Timekeeping Mode
 - When the watch is at Level 2 power saving
 - While a compass reading, barometric pressure measurement, temperature measurement, or altitude measurement operation is in progress
 - While the barometric pressure change indication is enabled
 - While a timer countdown operation is in progress
 - While the Home City area setting is one where time signal reception is not possible
 - While the watch is outside the time signal reception range
- When the receive operation is successful, the time and/or day settings will be adjusted automatically. Summer time will not be applied correctly in the case described below.
 - When the summer time start date and time, end date and time, or other rules are changed by authorities
- As of January 2021, China does not observe summer time. If China starts to observe summer time in the future, the time displayed by the watch for China may not be correct.

Using Watch Operations to Adjust the Time Setting

If, for some reason, you cannot use time signal reception to adjust the current time setting, you can adjust date, time, and Home City settings manually using watch button operations.

● Setting a Home City

Use the procedure in this section to select a city to use as your Home City. If you are in an area that observes summer time, you can also enable or disable summer time.

1. Enter the Timekeeping Mode.
[🔗 Navigating Between Modes](#)

2. Pull out the crown.

This causes [CITY] to flash on the display and the second hand to move to the current Home City.

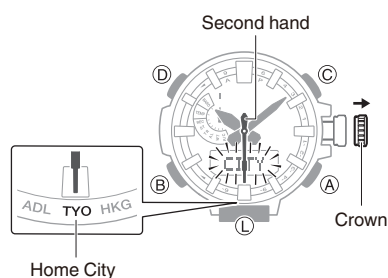

3. Rotate the crown to move the second hand to the city code of the city you want to set as your Home City.

- For information about city codes, refer to the information below.
[🔗 City Table](#)

4. Press (B).

5. Rotate the crown to select a summer time setting.

Rotating the crown cycles through the setting items shown below.

- [AUTO]
The watch switches between standard time and summer time automatically.
- [OFF]
The watch always indicates standard time.
- [ON]
The watch always indicates summer time.

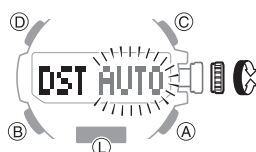

6. Push the crown back in to complete the setting operation.

Note

- If you do not perform any operation for about two minutes after pulling out the crown, crown operations will automatically become disabled. If that happens, push the crown back in and then pull it out again.
- The [AUTO] summer time setting is valid when the watch's Home City is in an area where a time signal can be received.

● Setting the Time/Date

You can use the procedure below to adjust the time and date settings when using the watch where signal reception is not possible.

Important!

- If you are using the watch in an area where signal receive operations are possible, time and date settings using the time signal is recommended.
- Configure the Home City setting before changing the current time and date settings.
[🔗 Setting a Home City](#)

1. Enter the Timekeeping Mode.
[🔗 Navigating Between Modes](#)

2. Pull out the crown.

This causes [CITY] to flash on the display and the second hand to move to the current Home City.

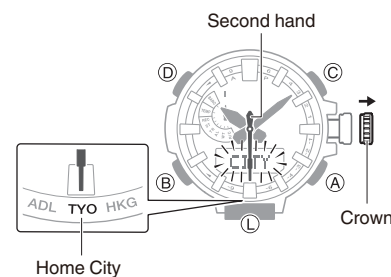

3. Press (D).

This causes [HOUR-MIN] to flash on the display.

- You can see if a time is a.m. ([A]) or p.m. ([P]) by checking the second hand position.

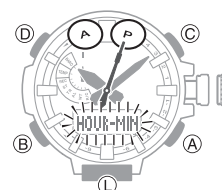

4. Rotate the crown to change the minute setting.

5. Press (B).

This causes [HOUR] to flash on the display.

6. Rotate the crown to change the hour setting.

7. Press (B).

This causes the current year setting to flash on the display.

8. Rotate the crown to change the year setting.

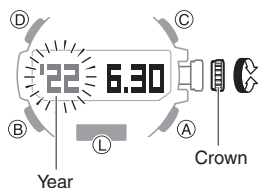

9. Press (B).

This causes the month and day to flash on the display.

10. Rotate the crown to change the month and day setting.

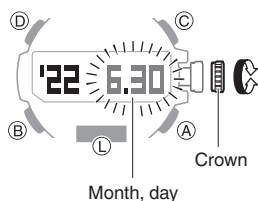

11. On a time signal at the top of a minute, push the crown back in to complete the setting operation.

Note

- If you do not perform any operation for about two minutes after pulling out the crown, crown operations will automatically become disabled. If that happens, push the crown back in and then pull it out again.

● Switching between 12-hour and 24-hour Timekeeping

You can specify either 12-hour format or 24-hour format for the time display.

1. Enter the Timekeeping Mode.

🔗 [Navigating Between Modes](#)

2. Pull out the crown.

This causes [CITY] to flash on the display and the second hand to move to the current Home City.

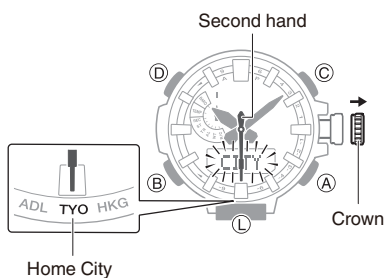

3. Press (B) five times.

This causes [12H] or [24H] to flash on the display.

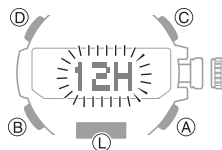

4. Rotate the crown to select [12H] (12-hour timekeeping) or [24H] (24-hour timekeeping).

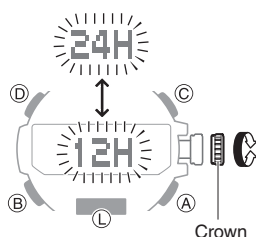

5. Push the crown back in to complete the setting operation.

Note

- If you do not perform any operation for about two minutes after pulling out the crown, crown operations will automatically become disabled. If that happens, push the crown back in and then pull it out again.

World Time

You can view the current time in 29 cities and UTC (Coordinated Universal Time) time.

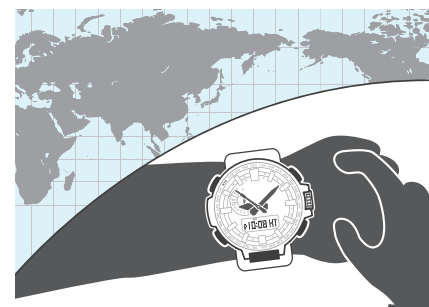

Checking World Time

1. Enter the World Time Mode.

🔗 [Navigating Between Modes](#)

This displays [WT] for about one second. Next, the hour and minute hands indicate the current time in your World Time City. At this time the second hand points to the city code of your World Time City.

- The digital display shows the current time in your Home City.
- To check whether the current time in your World Time City is a.m. or p.m., press (A). This will cause the second hand to move to [A] (a.m.) or [P] (p.m.). After three seconds, the second hand goes back to indicating the seconds.
- To cause the second hand to move to the currently selected city, press (D). After three seconds, the second hand goes back to indicating the seconds.

City Codes (World Time Codes)

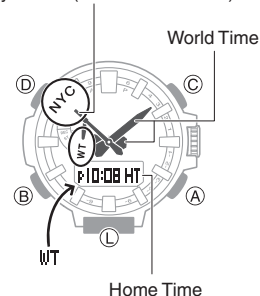

Specifying a World Time City

Use the procedure in this section to select a World Time city. If you are in an area that observes summer time, you can also enable or disable summer time.

1. Enter the World Time Mode.
[🔍 Navigating Between Modes](#)

2. Pull out the crown.

This causes [CITY] to flash on the display and the second hand to move to the current Home City.

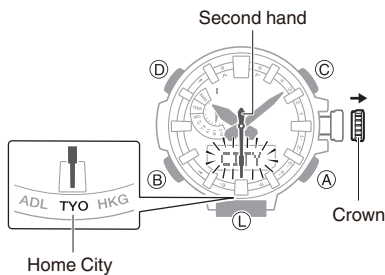

3. Rotate the crown to move the second hand to the city code of the city you want to specify as your World Time City.

This displays the current time in the city you select.

4. Press (B).

This causes [ON] or [OFF] to flash on the display.

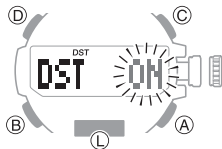

5. Rotate the crown to select a summer time setting.

- [OFF]
The watch always indicates standard time.
- [ON]
The watch always indicates summer time.

6. Push the crown back in to complete the setting operation.

Note

- If you do not perform any operation for about two minutes after pulling out the crown, crown operations will automatically become disabled. If that happens, push the crown back in and then pull it out again.
- While [UTC] is selected as the city, you will not be able to change or check the summer time setting.

● Specifying UTC (Coordinated Universal Time) as Your World Time City

To set UTC (Coordinated Universal Time) as your World Time City, enter the World Time Mode and then hold down (A) for at least three seconds.

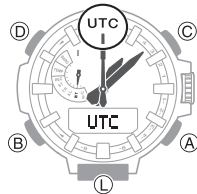

Swapping Your Home Time and World Time

In the World Time mode, hold down (D) for at least three seconds until [CITY] flashes, and your Home City time swaps places with your World Time.

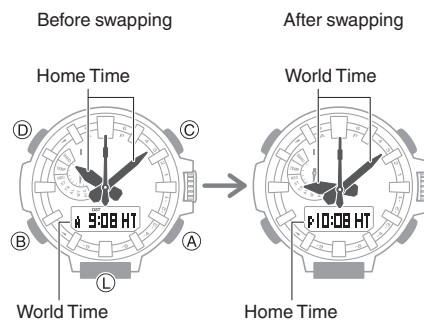

Alarm

The watch will beep when an alarm time is reached. You can set up to five different alarms. The hourly time signal causes the watch to beep every hour on the hour.

- The beeper will not sound if battery power is low.



Configuring Alarm Settings

1. Enter the Alarm Mode.
[🔍 Navigating Between Modes](#)

2. Use (A) and (C) to display the number ([AL1] to [AL5]) of the alarm whose settings you want to change.

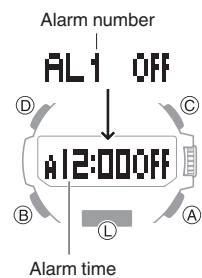

3. Pull out the crown.

This causes the hours and minutes digits to flash.

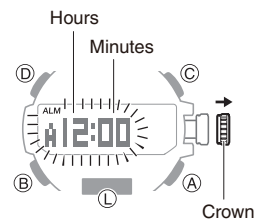

4. Rotate the crown to change the minute setting.

- The hour digit changes in sync with the minute digit change.

5. Press (B).

This causes the hours digits to flash.

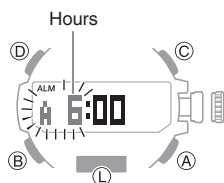

6. Rotate the crown to change the hour setting.

- If you are using 12-hour timekeeping, the time setting is indicated as [A] (a.m.) or [P] (p.m.).

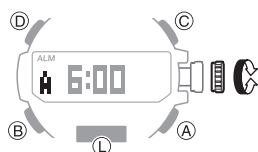

7. Push the crown back in to complete the setting operation.

Note

- If you do not perform any operation for about three minutes while in the Alarm mode, the watch automatically returns to the Timekeeping Mode.
- If you do not perform any operation for about two minutes after pulling out the crown, crown operations will automatically become disabled. If that happens, push the crown back in and then pull it out again.

● To stop the alarm

To stop the alarm after it starts to sound when an alarm time is reached, press any button.

Note

- A beeper sounds for 10 seconds when an alarm time is reached.

Enabling the Hourly Time Signal

1. Enter the Alarm Mode.

🔗 [Navigating Between Modes](#)

2. Press (A) or (C) to display the hourly time signal screen ([SIG]).



3. Press (D) to toggle the hourly time signal between enabled and disabled.

- [SIG] (hourly time signal) is shown on the display while the hourly time signal is enabled.



Turning Off an Alarm or the Hourly Time Signal

To stop an alarm or the hourly time signal from sounding, perform the steps below to turn it off.

- To have an alarm or hourly time signal sound again, turn it back on.

Note

- Indicators are displayed while any of the alarms or the hourly time signal is turned on.
- The applicable indicators are not displayed while all of the alarms are turned off and/or the hourly time signal is turned off.

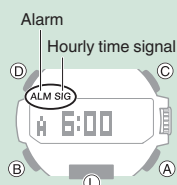

1. Enter the Alarm Mode.

🔗 [Navigating Between Modes](#)

2. Use (A) and (C) to scroll through alarm numbers ([AL1] to [AL5]) and the hourly time signal ([SIG]) screens until the one whose setting you want to change is displayed.

Alarm number or hourly time signal

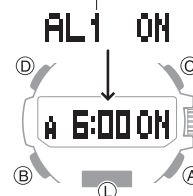

3. Press (D) to turn off the displayed alarm or the hourly time signal.

- Each press of (D) toggles between ON and OFF.
- Turning off all alarms causes [ALM] (alarm) to disappear from the display, while disabling the hourly time signal causes [SIG] (hourly time signal) to disappear from the display.

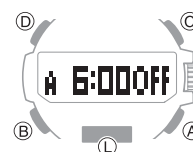

Note

- If [ALM] (alarm) is still displayed, it means that another alarm is still turned on. To turn off all of the alarms, repeat steps 2 and 3 until the [ALM] (alarm) indicator is no longer displayed.

Digital Compass

You can use the Compass Mode to determine the direction of north, and to check your bearing to a destination.



Important!

- Check the information at the link below to find out how to ensure correct readings.
 - 🔗 [Calibrating Compass Readings](#)
 - 🔗 [Digital Compass Reading Precautions](#)

Taking a Compass Reading

1. Enter the Compass Mode.
 - 🔗 [Navigating Between Modes](#)
 - This operation can also be performed in the Timekeeping Mode or Altimeter Mode.
2. Point 12 o'clock of the watch in the direction of your objective.
3. While keeping the watch horizontal, press (C).

This displays [COMP] and starts digital compass readings.

 - The second hand points North. The digital display shows one of 16 literal direction indications or the bearing angle.
 - To retrigger the compass operation, press (C).

Interpreting Bearing Readings

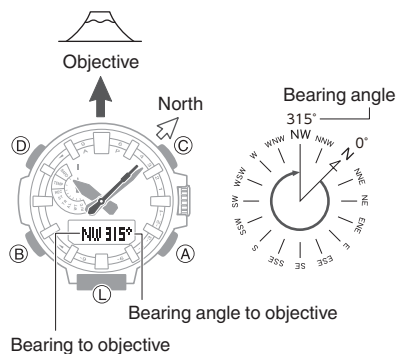

Directions: N (North), E (East), W (West), S (South)

Note

- Normally the compass indicates magnetic north. You can also configure settings to indicate true north.
 - 🔗 [Setting Up for True North Readings \(Magnetic Declination Calibration\)](#)
 - 🔗 [Magnetic North and True North](#)
- After the initial reading is displayed, the watch will continue to take readings about every second for about the next 60 seconds. The watch will return to the Timekeeping Mode automatically about 60 seconds after you press (C).
- Auto Light will not illuminate the face while a compass operation is in progress.
- If an alarm or other beeper sounds, or if you turn on illumination by pressing (L) while a compass operation is in progress, the compass operation will be suspended momentarily. The compass operation will resume when the beeper stops or illumination turns off.
- If you do not perform any operation for about one minute while in the Compass Mode, the watch automatically returns to the Timekeeping Mode.

Aligning a Map with Actual Surroundings (Setting a Map)

Setting a map means to align the map so the directions indicated on it are aligned with the actual directions of your location. Once you set a map, you can more easily get a grasp of the relationship between map markings and actual geographic contours. To set a map with this watch, align north on the map with the north indication of the watch. Once you set the map, you can compare your bearing on the map with your surroundings, which will help you determine your current location and destination.

- Note that map reading skills and experience are required to determine your current location and destination on a map.

Calibrating Compass Readings

Calibrating Compass Readings

Perform 2-point calibration whenever you notice the watch's compass readings are different from those of another compass, or before setting out on a climb or trek.

- Note that accurate compass readings and/or calibration will not be possible in an area where strong magnetism is present.
 - 🔗 [Digital Compass Reading Precautions](#)

2-Point Calibration

1. Enter the Compass Mode.
 - 🔗 [Navigating Between Modes](#)
2. Pull out the crown.

This displays [↑ 1].

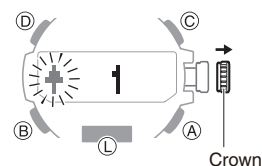

- While keeping the watch horizontal, press (C).

This starts calibration of the first point, which causes [↑ WAIT] to appear on the display. When calibration is successful, indicators appear on the display in the following sequence: [OK] → [Turn 180°] → [↓ 2].

- Rotate the watch 180 degrees, taking care to be as exact as possible.

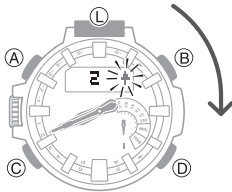

- Press (C).

- This starts calibration of the second point, which causes [↓ WAIT] to appear on the display.
- When calibration is successful, [OK] appears on the display and the watch returns to the Digital Compass screen.

- Push the crown back in to complete the calibration operation.

Note

- If you do not perform any operation for about two minutes after pulling out the crown, crown operations will automatically become disabled. If that happens, push the crown back in and then pull it out again.
- [ERR] will appear if calibration fails for some reason. If this happens, restart the above procedure from step 2.

Setting Up for True North Readings (Magnetic Declination Calibration)

If you want the watch to indicate true north instead of magnetic north, you need to specify your current location's magnetic declination direction (east or west) and declination angle.

Magnetic North and True North

- The magnetic declination angle value can be set in 1° (degree) units only. Use a value that is closest to the angle you want to set.
Example: For an angle of 7.4°, set 7°.
Example: For an angle of 7°40' (7 degrees, 40 minutes), set 8°.

Note

- Magnetic declination angles (east or west) and angle degree values for specific locations can be found on geographic maps, mountain climbing maps, and other maps that include contour lines.

- Enter the Compass Mode.

⌚ Navigating Between Modes

- Pull out the crown.

This displays [↑ 1].

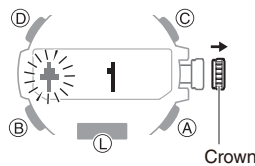

- Press (B).

This displays [DEC] and the current magnetic declination setting.

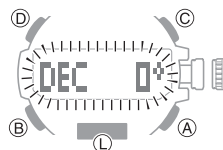

- Rotate the crown to select a magnetic declination direction and angle settings as desired.

Setting range: 90° west to 90° east

[OFF]: Magnetic north

[E]: East declination (Magnetic north is east of true north.)

[W]: West declination (Magnetic north is west of true north.)

- To return the setting to [OFF], press (A) and (C) at the same time.

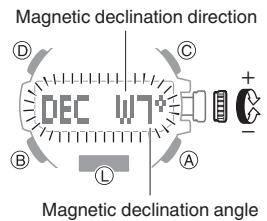

- Push the crown back in to complete the setting operation.

Note

- If you do not perform any operation for about two minutes after pulling out the crown, crown operations will automatically become disabled. If that happens, push the crown back in and then pull it out again.

● Magnetic North and True North

There are actually two types of north: magnetic north and true north.

Magnetic north: North indicated by the needle of a compass

True north: Direction to the North Pole

As shown in the illustration below, magnetic north and true north are not the same.

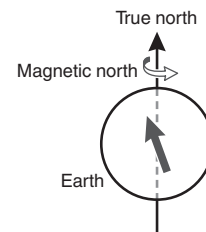

Note

- The north indicated on commercially available maps is normally true north.

Digital Compass Reading Precautions

Location During Use

Taking readings near sources of strong magnetism can cause reading error. Keep the watch away from the following types of items.

Permanent magnets (magnetic accessories, etc.), metal objects, high-voltage wires, aerial wires, electrical household appliances (TVs, computers, cellphones, etc.)

- Note that correct direction readings are not possible indoors, especially inside of reinforced concrete structures.
- Accurate direction readings are not possible on electric trains, on boats, on aircraft, etc.

Storage Location

Exposure of the watch to magnetism can affect the accuracy of digital compass readings. Keep the watch away from the types of items below.

Permanent magnets (magnetic accessories, etc.), metal objects, electrical household appliances (TVs, computers, cellphones, etc.)

Altitude Measurement

The watch takes altitude readings and displays results based on air pressure measurements taken by a built-in pressure sensor.

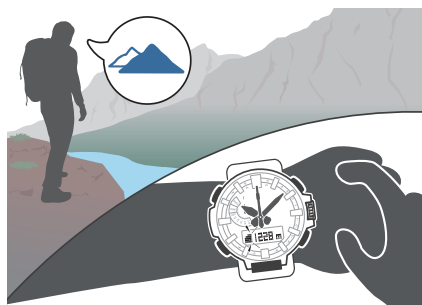

Important!

- The altitude readings displayed by the watch are relative values that are calculated based on barometric pressure measured by the watch's pressure sensor. This means that barometric pressure changes due to weather can cause altitude readings taken at the same location to be different. Also note that the value displayed by the watch may be different from the actual elevation and/or sea level elevation indicated for the area where you are located. When using the watch's altimeter while mountain climbing, it is recommended that you regularly calibrate its readings in accordance with local altitude (elevation) indications.
 - 🔗 [Calibrating Altitude Readings \(Offset\)](#)
- Check the information at the link below to find out about how to minimize differences between readings produced by the watch, and values provided by local altitude (elevation) indications.
 - 🔗 [Calibrating Altitude Readings \(Offset\)](#)
 - 🔗 [Altitude Reading Precautions](#)

Checking the Current Altitude

1. Enter the Altimeter Mode.

🔗 [Navigating Between Modes](#)

Entering the Altimeter Mode will start altitude measurement and display the altitude at your current location.

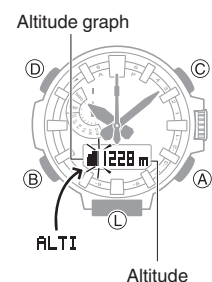

- The watch takes altitude readings every second for about the first three minutes. After that, it takes readings according to the watch's auto measurement interval setting.
- Check the information at the link below to find out how to configure the auto measurement interval.
 - 🔗 [Setting the Auto Measurement Interval](#)
- To retrigger measurement, press (A).
- To return to the Timekeeping Mode, press (B).

Note

- If the hour and/or minute hand is located over the digital display when you perform an altitude measurement, the hands will temporarily shift to 4 o'clock or 8 o'clock to allow easier reading of measurement values. The hands will unshift to their normal positions after about three seconds.
- When you enter the Altitude Mode, the second hand indicates either timekeeping seconds, or the differential between altitude measurements (whichever was indicated the last time you were in the Altitude Mode). You can toggle between the two second hand functions by pressing (D).
- Measurement range: -700 to 10,000 meters (-2,300 to 32,800 feet) (Measurement unit: 1 meter (5 feet)) Note that calibrating altitude readings will cause a change in the measurement range.
- [- -] will appear for the measured value if it is outside the allowable range.

Interpreting Altitude Graph Contents

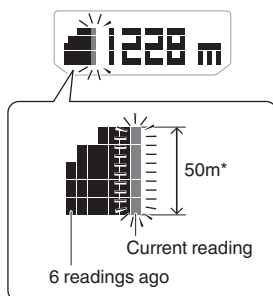

* 1 square (■) is 10 m.

Calibrating Altitude Readings (Offset)

To minimize the difference between locally indicated and measured values, you should update the reference altitude value (offset) before setting off and during treks or any other activities where you take altitude readings.

Also, you can ensure accurate measurements by checking a map local altitude indications or some other source for your current location's altitude, and regularly calibrating watch readings with the latest information while mountain climbing.

Note

- You can find out the altitude at your current location from signs, maps, on the Internet, etc.
- Differences between actual altitude and watch readings can be caused by the factors below.
 - Changes in barometric pressure
 - Changes in temperature caused by variations in barometric pressure and by elevation
- Though altitude readings can be taken without calibration, doing so may produce readings that are very different from indications by altitude markers, etc.

- Enter the Altimeter Mode.
[Navigating Between Modes](#)

- Pull out the crown.

This displays the current altitude and enters the Altitude Offset Mode.

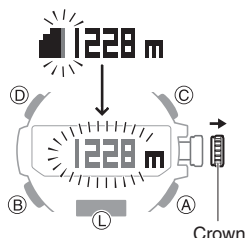

- Rotate the crown to calibrate the displayed value to that of a local altitude (elevation) marker.

Setting range: -3,000 to 10,000 meters (or -9,840 to 32,800 feet)

Setting unit: 1 meter (or 5 feet)

- To return the altitude setting to its initial factory default, press (A) and (C) at the same time.

- Push the crown back in to complete the setting operation.

Note

- If you do not perform any operation for about two minutes after pulling out the crown, crown operations will automatically become disabled. If that happens, push the crown back in and then pull it out again.

Checking the Altitude Differential from a Reference Point

After you set a reference altitude, the second hand of the watch will indicate the difference between your current altitude and the reference altitude. This makes it easy to measure the altitude difference between two points while climbing or trekking.

● Setting the Altitude Differential Measurement Range

- Enter the Altimeter Mode.
[Navigating Between Modes](#)

- Pull out the crown.

This displays the altitude for your current location.

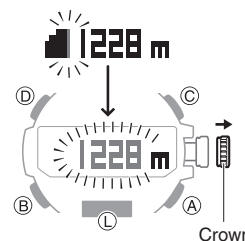

- Press (B) twice.

This displays the altitude differential measurement range.

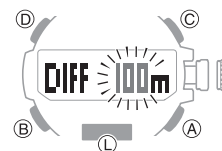

- Rotate the crown to select either [100m] or [1000m].

[100m]: ±100 meters (±328 feet) in 5-meter (16-foot) units

[1000m]: ±1000 meters (±3280 feet) in 50-meter (164-foot) units

- Push the crown back in to complete the setting operation.

Note

- If you do not perform any operation for about two minutes after pulling out the crown, crown operations will automatically become disabled. If that happens, push the crown back in and then pull it out again.

Measuring Altitude

1. Use the contour lines on your map to determine the altitude differential between your current location and your destination.

2. Take an altitude reading of your current location.

[Checking the Current Altitude](#)

3. Hold down (D) for at least two seconds to set your current location's altitude as the reference altitude.

This displays [DIFF RESET] → [RESET] and then your current altitude.

- The second hand (Altitude Differential Indicator) will indicate the difference between the reference altitude and the current altitude reading. At this time the second hand should indicate ± 0 m (± 0 feet).

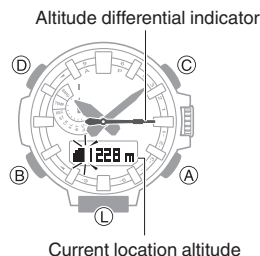

4. While comparing the difference between the altitude you found on the map and the altitude differential indicated by the watch's second hand, advance towards your destination.

- When the altitude differential you found on the map is the same as that indicated by the second hand, it means you are close to your destination.

Example: Altitude differential of -30 m (-98 feet) (-300 m (-984 feet))

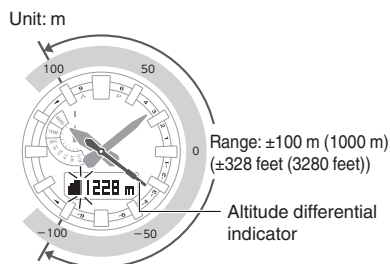

Note

- You can toggle between the two second hand functions by pressing (D).
[Checking the Current Altitude](#)
- The second hand points to ▲ (over) if the current altitude differential is greater than the setting value, or ▼ (under) if it is lower than the setting value.
If either of these is indicated while using the ± 100 m (328 feet) measurement range, change the range setting to ± 1000 m (3280 feet).
- The second hand will move to 9 o'clock if a reading is outside the allowable altitude measurement range (-700 m to 10,000 m (-2,300 to 32,800 feet)), or if a reading error occurs.

Setting the Auto Measurement Interval

You can select an auto measurement interval of either five seconds or two minutes.

1. Enter the Altimeter Mode.
[Navigating Between Modes](#)

2. Pull out the crown.

This displays the altitude for your current location.

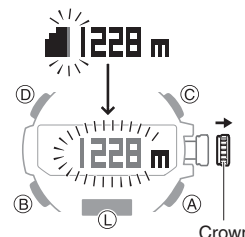

3. Press (B).

This causes the auto measurement interval to appear on the display.

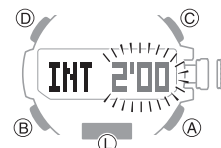

4. Rotate the crown to select [0'05] or [2'00] as the auto measurement interval.

[0'05]: Readings taken every second for the first three minutes, and then every five seconds for about the next one hour.

[2'00]: Readings taken every second for the first three minutes, and then every two minutes for about the next 12 hours.

5. Push the crown back in to complete the setting operation.

Note

- If you do not perform any operation for about two minutes after pulling out the crown, crown operations will automatically become disabled. If that happens, push the crown back in and then pull it out again.
- The watch will automatically return to the Timekeeping Mode if you do not perform any operation in the Altimeter Mode for about one hour while [0'05] is selected as the measurement interval or about 12 hours while [2'00] is selected.

Recording Altitude Readings

Use the procedure below to record altitude measurements manually. Auto measurements are also recorded automatically.

- Use the Altitude Record Recall Mode to view or delete records.
[Viewing Altitude Records](#)

Recording Altitude Data Manually

1. Enter the Altimeter Mode.
[Navigating Between Modes](#)
2. Hold down (A) for at least two seconds until [REC] stops flashing on the display.
 This records the current altitude, date, and time.
 - There is enough memory to hold up to 30 altitude records.
 - Recording altitude data when there are already 30 records in memory automatically deletes the oldest record to make room for the new one.



Auto Altitude Data Recording

The altitude data described below is recorded automatically while the watch is in the Altimeter Mode. One record each is maintained in memory for each of these items.

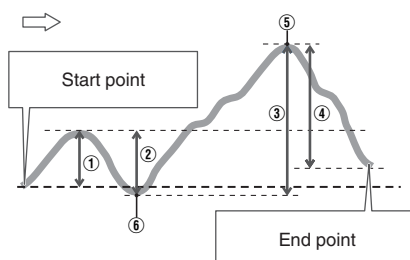

High Altitude (MAX): (5)

Low Altitude (MIN): (6)

Cumulative Ascent (ASC): (1)+(3)*

Cumulative Descent (DSC): (2)+(4)*

* Cumulative ascent and cumulative descent values are updated whenever there is a difference of at least ± 15 m (± 49 feet) from one reading to the next.

Note

- Auto recording ends when you exit the Altimeter Mode. Re-entering the Altimeter Mode restarts recording of cumulative values from where it was stopped when you last exited the Altimeter Mode.

Specifying the Altitude Measurement Unit

You can select either meters (m) or feet (ft) as the Altimeter Mode display unit.

Important!

- When Tokyo (TYO) is set as the Home City, the altitude unit is fixed as meters (m) and cannot be changed.

1. Enter the Altimeter Mode.
[Navigating Between Modes](#)

2. Pull out the crown.
 This displays the current altitude and enters the Altitude Offset Mode.

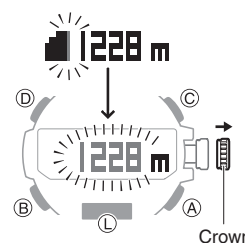

3. Press (B) three times.
 This causes [UNIT] to appear, with [m] or [ft] flashing.

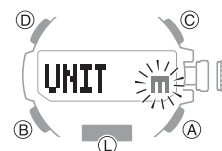

4. Rotate the crown to select an altitude unit.
 [m]: Meters
 [ft]: Feet



5. Push the crown back in to complete the setting operation.

Note

- If you do not perform any operation for about two minutes after pulling out the crown, crown operations will automatically become disabled. If that happens, push the crown back in and then pull it out again.

Altitude Reading Precautions

Effects of Temperature

When taking altitude readings, take the steps below to keep the watch at as stable a temperature as possible. Changes in temperature can affect altitude readings.

- Take readings with the watch on your wrist.
- Take readings in an area where temperature is stable.

Altitude Readings

- Do not use this watch while skydiving, hang gliding, paragliding, gyrocopter flying, glider flying, or engaged in other activities where altitude changes suddenly.
- Altitude readings produced by this watch are not intended for special-purpose or industrial level use.
- In an aircraft, the watch measures the in-cabin pressurized air pressure, so readings will not match altitudes announced by the crew.

Altitude Readings (Relative Altitude)

This watch uses International Standard Atmosphere (ISA) relative altitude data defined by the International Civil Aviation Organization (ICAO). Barometric pressure generally becomes lower as altitude increases.

Correct measurement may not be possible under the conditions below.

- During unstable atmospheric conditions
- During sudden temperature changes
- After the watch has been subjected to strong impact

Barometric Pressure Measurement

You can use the Barometer Mode to take a reading of the barometric pressure at your current location, and to track reading changes and trends.

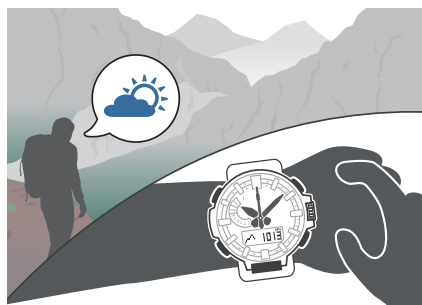

Important!

- Check the information at the link below to find out how to ensure correct readings.
 - ◉ [Calibrating Barometric Pressure Readings \(Offset\)](#)
 - ◉ [Barometric Pressure Reading Precautions](#)

Checking the Current Barometric Pressure

1. Enter the Barometer Mode.

◉ [Navigating Between Modes](#)

Entering the Barometer Mode starts measurement, and displays the barometric pressure at your current location and a barometric pressure graph.

- After you enter the Barometer Mode, the watch takes readings about every five seconds for three minutes. After that, a measurement is taken about every two minutes.

Barometric pressure graph

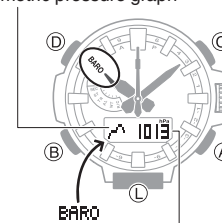

Barometric pressure

- To retrigger measurement, press (A).
- To return to the Timekeeping Mode, hold down (B) for at least two seconds.

Note

- If the hour and/or minute hand is located over the digital display when you perform a barometric pressure measurement, the hands will temporarily shift to 4 o'clock or 8 o'clock to allow easier reading of measurement values. The hands will unshift to their normal positions after about three seconds.
- When you enter the Barometer Mode, the second hand indicates either timekeeping seconds, or the differential between barometer measurements (whichever was indicated the last time you were in the Barometer Mode). You can toggle between the two second hand functions by pressing (D).
- The watch will automatically return to the Timekeeping Mode from the Barometer mode if you do not perform any operation for about one hour.
- The measurement range is 260 hPa to 1,100 hPa (7.65 inHg to 32.45 inHg) (1 hPa (0.05 inHg) units). [- -] will appear for the measured value if it is outside the allowable range.

Checking Changes in Barometric Pressure Over Time

The watch displays a graph of 20 hours of barometric pressure readings taken every two hours. The square (■) at the far right of the graph indicates the latest barometric pressure reading.

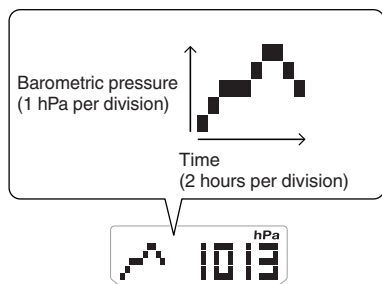

● Predicting Upcoming Weather

A trend like this:	Means this:
	Rising barometric pressure, which indicates that upcoming weather probably will be fair.
	Falling barometric pressure, which indicates that upcoming weather probably will be bad.

Note

- Large changes in barometric pressure and/or temperature can cause past data readings to be plotted outside of the visible area of the graph. Though plots are not visible, the data is still maintained in watch memory.
- The barometric pressure graph is not displayed while Barometric Pressure Change Indications are displayed.
 - [Sudden Barometric Pressure Change Indications](#)

Checking the Change in Barometric Pressure between Two Readings

When you perform the procedure below in the Barometer Mode, the second hand indicates the difference between the current barometric pressure measurement and the last auto measurement value (taken at two-hour intervals).

1. Enter the Barometer Mode.
 - [Navigating Between Modes](#)

2. Press (D).

The second hand indicates the barometric pressure differential (Pressure Differential Indicator).

Example: Barometric pressure differential of -3 hPa (approximately -0.09 inHg)

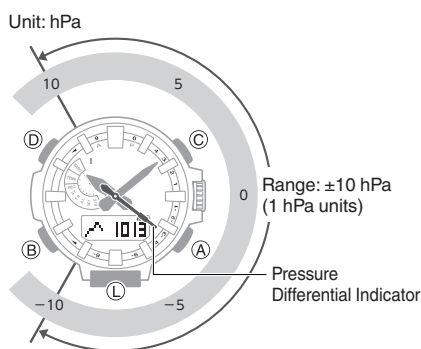

Note

- You can toggle between the two second hand functions by pressing (D).
 - [Checking the Current Barometric Pressure](#)
- The second hand points to ▲ (over) if the current barometric pressure differential is greater than +10 hPa (0.3 inHg), or ▼ (under) if it is less than -10 hPa (-0.3 inHg).
- A reading that is outside the allowable measurement range of 260 hPa to 1,100 hPa (7.65 inHg to 32.45 inHg), or any measurement error will cause the second hand to move to 9 o'clock.

Sudden Barometric Pressure Change Indications

Whenever the watch detects a significant change in air pressure readings (due to sudden ascent or descent, or to the passage of a low pressure or high pressure area), it will beep to let you know. An arrow will also flash on the display at this time if the watch is in the Barometer Mode, or if it is in the Timekeeping Mode with the barometric pressure graph displayed. The arrow that appears shows the direction of the pressure change. These alerts are called “Barometric Pressure Change Indications”.

This indicator:	Means this:
	Sudden drop in pressure
	Sudden rise in pressure
	Sustained rise in pressure, shifting to a fall
	Sustained fall in pressure, shifting to a rise

Important!

- To ensure correct barometric pressure change indicator operation, enable it in a location where the altitude is constant (such as a lodge, camp area, or on the ocean).
- A change in altitude causes a change in air pressure. Because of this, correct readings are impossible. Do not take readings while ascending or descending a mountain, etc.

1. Enter the Barometer Mode.
 Navigating Between Modes

2. Hold down (D) for at least two seconds.
 If this turns on barometric pressure change indication, [INFO ON] will stop flashing and then the [BARO] indicator will appear on the display.

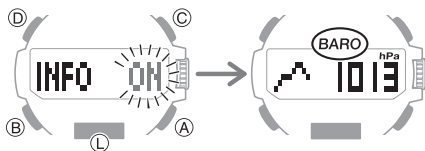

3. To disable barometric pressure change indication, hold down (D) again for at least two seconds.

Note

- If Barometric Pressure Change Indications are on, barometric pressure readings are taken every two minutes even while the watch is not in the Barometer Mode.
- The Barometric Pressure Change Indication becomes disabled automatically 24 hours after it is enabled.
- You will not be able to turn on barometric pressure change indication if the watch's battery level is low.
- Low battery power will also cause barometric pressure change indication to turn off automatically.

Calibrating Barometric Pressure Readings (Offset)

The watch's pressure sensor is adjusted at the factory and normally does not require calibration. However, you can calibrate the displayed value if you notice major errors in readings.

Important!

- The watch will not be able to produce correct barometric pressure readings if you make a mistake during the calibration procedure. Check to make sure that the value you use for calibration produces correct pressure readings.

1. Enter the Barometer Mode.
 Navigating Between Modes

2. Pull out the crown.
 This displays the current barometric pressure and enters the Barometric Pressure Offset Mode.

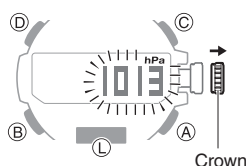

3. Rotate the crown to change the value.
 Setting range: 260 to 1,100 hPa (or 7.65 inHg to 32.45 inHg)
 Setting unit: 1 hPa (or 0.05 inHg)
 - To return the barometric pressure setting to its initial factory default, press (A) and (C) at the same time.
4. Push the crown back in to complete the setting operation.

Note

- If you do not perform any operation for about two minutes after pulling out the crown, crown operations will automatically become disabled. If that happens, push the crown back in and then pull it out again.

Specifying the Barometric Pressure Unit

You can specify either hectopascals (hPa) or inches of mercury (inHg) as the display unit for barometric pressure values.

Important!

- When Tokyo (TYO) is the Home City, the barometric pressure unit is fixed as hectopascals (hPa) and cannot be changed.

1. Enter the Barometer Mode.
 Navigating Between Modes

2. Pull out the crown.
 This displays the current barometric pressure.

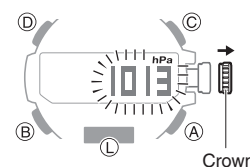

3. Press (B).
 This causes [UNIT] to appear, with [hPa] or [inHg] flashing.

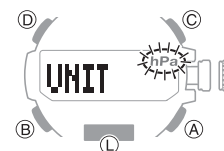

4. Rotate the crown to select a barometric pressure unit.
 [hPa]: Hectopascals
 [inHg]: Inches of mercury

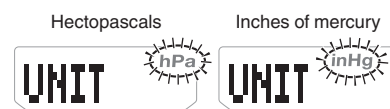

5. Push the crown back in to complete the setting operation.

Note

- If you do not perform any operation for about two minutes after pulling out the crown, crown operations will automatically become disabled. If that happens, push the crown back in and then pull it out again.

Barometric Pressure Reading Precautions

- The barometric pressure graph produced by this watch can be used to obtain an idea of upcoming weather conditions. However, this watch should not be used in place of precision instruments required for official weather prediction and reporting.
- Pressure sensor readings can be affected by sudden changes in temperature. Because of this, there may be some error in the readings produced by the watch.

Temperature Measurement

The watch can be used to take current air temperature readings.

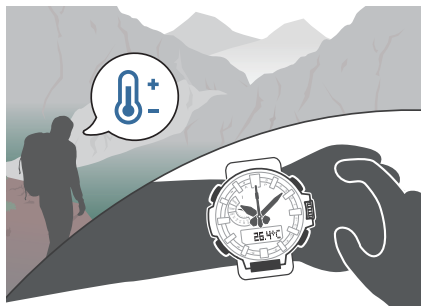

Important!

- Check the information at the link below to find out how to ensure correct readings.
[Temperature Reading Precautions](#)

Checking the Current Temperature

1. Enter the Thermometer Mode.
[Navigating Between Modes](#)
 Entering the Thermometer Mode will start temperature measurement and display the result.
 - After you enter the Thermometer Mode, the watch takes readings about every five seconds for three minutes. After that, a measurement is taken about every two minutes.
 - To retrigger measurement, press (A).

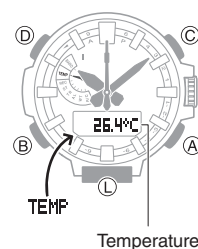

Note

- If the hour and/or minute hand is located over the digital display when you perform a temperature measurement, the hands will temporarily shift to 4 o'clock or 8 o'clock to allow easier reading of measurement values. The hands will unshift to their normal positions after about three seconds.
- The watch will automatically return to the Timekeeping Mode if you do not perform any operation in the Thermometer Mode for about one hour.
- The measuring range is -10.0 °C to 60.0 °C (14.0 °F to 140.0 °F) (0.1 °C (0.2 °F) units). [- - -] will appear for the measured value if it is outside the allowable range.
- To return to the Timekeeping Mode, hold down (B) for at least two seconds.

Calibrating Temperature Readings (Offset)

The watch's temperature sensor is adjusted at the factory and normally does not require calibration. However, you can calibrate the displayed value if you notice major errors in readings.

Important!

- Check to make sure that the value you use for calibration produces correct temperature readings.
- Before calibrating the temperature reading, remove the watch from your wrist and leave it in the area where you plan to measure temperature for about 20 or 30 minutes to allow the case temperature to become the same as the air temperature.

1. Enter the Thermometer Mode.
[🔍 Navigating Between Modes](#)

2. Pull out the crown.
 This displays the current temperature.

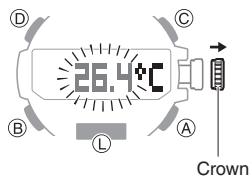

3. Rotate the crown to calibrate the temperature value.
 Calibration unit: 0.1 °C (0.2 °F)
 - To return the barometric pressure setting to its initial factory default, press (A) and (C) at the same time.

4. Push the crown back in to complete the setting operation.

Note

- If you do not perform any operation for about two minutes after pulling out the crown, crown operations will automatically become disabled. If that happens, push the crown back in and then pull it out again.

Specifying the Temperature Measurement Unit

You can select either Celsius (°C) or Fahrenheit (°F) as the temperature display unit.

Important!

- When Tokyo (TYO) is the Home City, the temperature unit is fixed as Celsius (°C) and cannot be changed.

1. Enter the Thermometer Mode.
[🔍 Navigating Between Modes](#)

2. Pull out the crown.
 This displays the current temperature.

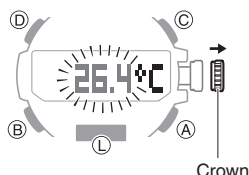

3. Press (B).
 This causes [UNIT] to appear, with [°C] or [°F] flashing.

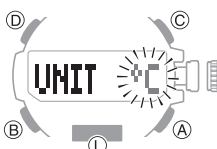

4. Rotate the crown to select a temperature unit.
 [°C]: Celsius
 [°F]: Fahrenheit



5. Push the crown back in to complete the setting operation.

Note

- If you do not perform any operation for about two minutes after pulling out the crown, crown operations will automatically become disabled. If that happens, push the crown back in and then pull it out again.

Temperature Reading Precautions

Body temperature, direct sunlight, and humidity all have an effect on temperature readings. To help ensure more accurate temperature readings, remove the watch from your wrist, wipe it dry of any moisture, and place it in a well-ventilated location not exposed to direct sunlight. You should be able to take temperature readings after about 20 to 30 minutes.

Viewing Altitude Records

You can use the Altitude Record Recall Mode to view manually recorded and auto recorded data.

Recording Altitude Readings

Viewing Recorded Data

- Enter the Altitude Record Recall Mode.
 Navigating Between Modes
 This displays a record of data recorded in the Altimeter Mode.
- Use (A) and (C) to display the data you want to view.
 - Holding down (A) or (C) scrolls at high speed.

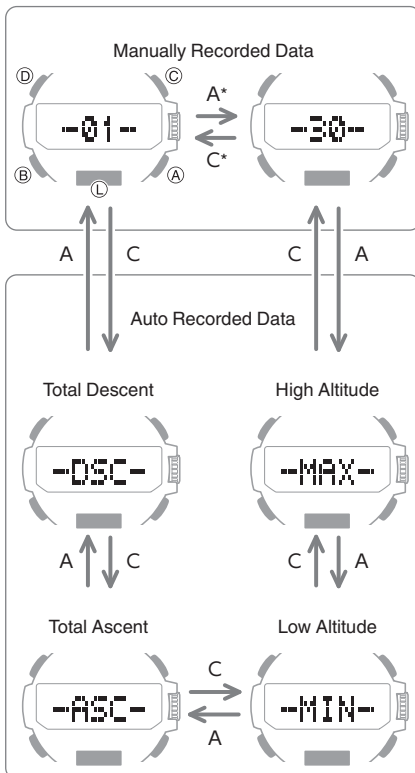

* Each press of a button scrolls to the top screen of the next manually recorded data record, numbered from 1 ([-01-]) to a maximum of 30 ([-30-]).

Note

- If there is no data left in memory due to a data delete operation, error, or some other reason, [- - -] or [0] will appear on the display.
- If the cumulative ascent (ASC) or cumulative descent (DSC) value exceeds 99,999 m (327,995 feet), it will revert to 0 and continue from there.
- Pressing (D) returns to the top screen (record number, DSC, ASC, MAX, or MIN) of the data that you are viewing.
- If you do not perform any operation for about three minutes while in the Altitude Record Recall Mode, the watch automatically returns to the Timekeeping Mode.

Manually Recorded Data

After displaying the top screen of a manually recorded data record (01 through 30), the record's data screens appear in sequence as shown below.

Example: Manually recorded Record 01

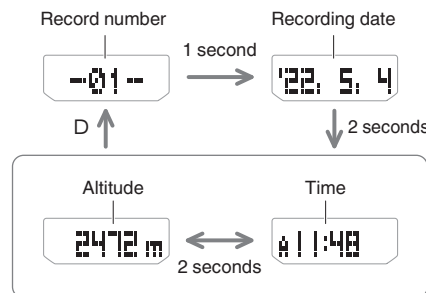

Auto Recorded Data

After displaying an auto recorded data record, you can navigate between the record's data screens as shown below.

High altitude and low altitude

Example: High altitude



Cumulative ascent and cumulative descent

Example: Cumulative ascent

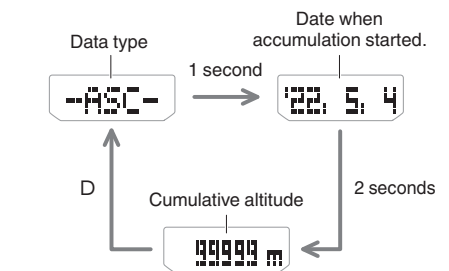

Deleting Data

● Deleting a Particular Record

1. Enter the Altitude Record Recall Mode.
[🔍 Navigating Between Modes](#)
2. Use the (A) and (C) buttons to scroll through the top screens of the records and display the one you want to delete .
3. Hold down the (D) for at least two seconds. Release the button as soon as [CLEAR] stops flashing.
 This deletes the record you selected.



- Note that holding down (D) for more than five seconds will delete all data.

● Deleting All Records

Hold down (D) for at least five seconds until [CLEAR ALL] stops flashing. This indicates that all data was deleted.



Stopwatch

The stopwatch can be used to perform 1/100 second elapsed time measurement up to 23 hours, 59 minutes, 59.99 seconds.

It can also measure split times.



Measuring Elapsed Time

1. Enter the Stopwatch Mode.
[🔍 Navigating Between Modes](#)
2. Use the operations below to measure elapsed time.

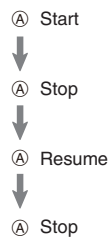

Hours, minutes, seconds, 1/100 seconds

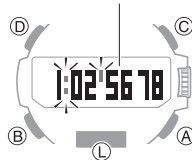

3. Press (C) to reset the measurement time to all zeros.

Measuring a Split Time

1. Enter the Stopwatch Mode.
[🔍 Navigating Between Modes](#)
2. Use the operations below to measure elapsed time.

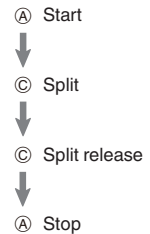

Hours, minutes, seconds, 1/100 seconds

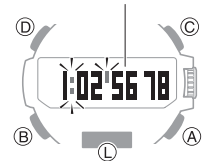

3. Press (C) to reset the measurement time to all zeros.

Timing the First and Second Place Finishers

1. Enter the Stopwatch Mode.
[🔍 Navigating Between Modes](#)
2. Use the operations below to measure elapsed time.



* Displays the time of the first finisher.

Hours, minutes, seconds, 1/100 seconds

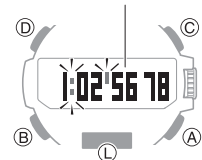

3. Press (C) to display the time of the second place finisher.
4. Press (C) to reset the measurement time to all zeros.

Timer

The timer counts down from a start time specified by you. A beeper sounds when the end of the countdown is reached.

- The beeper will not sound if battery power is low.

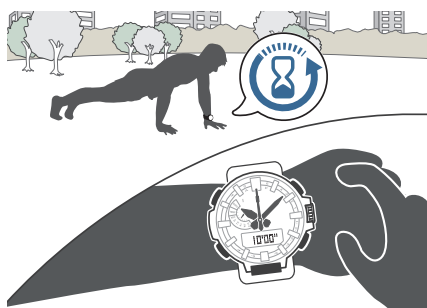

Setting a Start Time

The start time can be set in 1-minute units up to 60 minutes.

1. Enter the Timer Mode.
[🔍 Navigating Between Modes](#)

2. Pull out the crown.
 This causes the minutes digits to flash.

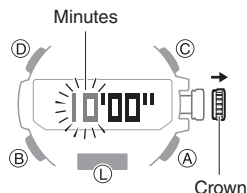

3. Rotate the crown to change the timer start time minutes.
4. Push the crown back in to complete the setting operation.

Note

- If you do not perform any operation for about two minutes after pulling out the crown, crown operations will automatically become disabled. If that happens, push the crown back in and then pull it out again.

Using the Timer

1. Enter the Timer Mode.
[🔍 Navigating Between Modes](#)
2. Use the operations below to perform a timer operation.

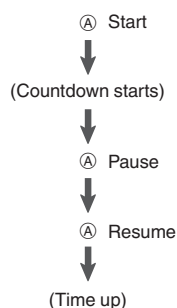

- A beeper will sound for 10 seconds to let you know when the end of a countdown is reached.
 - You can reset a paused countdown to its start time, by pressing (C).
3. Press any button to stop the tone.

Hand Alignment Adjustment

Strong magnetism or impact can cause the time indicated by the analog hands to become different from the time on the display. If this happens, adjust hand alignment.

Adjusting Hand Alignment

1. Enter the Timekeeping Mode.
[🔍 Navigating Between Modes](#)

2. Pull out the crown.
 This causes [CITY] to flash on the display and the second hand to move to the time indicated by the analog hands to become different from the time on the display. If this happens, adjust hand alignment.

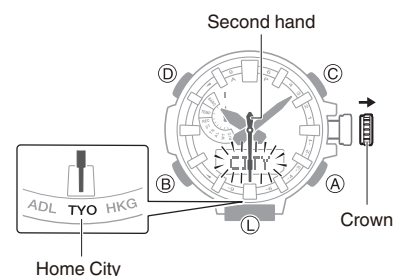

3. Hold down (A) for at least five seconds. Release the button when [HAND ADJ] starts to flash.

This indicates that hand alignment adjustment has started.

- [HAND SET] will flash first on the display about 0.5 seconds after you hold down the (A) button. Keep the button depressed until [HAND ADJ] flashes on the display.

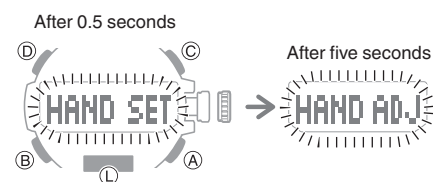

4. After all the hands move to 12 o'clock, push the crown back in.

This returns the hands to normal timekeeping.

Note

- If you do not perform any operation for about two minutes after pulling out the crown, crown operations will automatically become disabled. If that happens, push the crown back in and then pull it out again.

Important!

- After hand position adjustment is complete, check to make sure that the proper time is being indicated in the Timekeeping Mode by the hands and on the display. If the hands are misaligned, perform steps 2 through 4 again.

Other Settings

This section explains other watch settings you can configure.

Enabling the Button Operation Tone

Use the procedure below to enable or disable the tone that sounds when you press a button.

- Enter the Timekeeping Mode.
[Navigating Between Modes](#)

- Pull out the crown.

This causes [CITY] to flash on the display and the second hand to move to the current Home City.

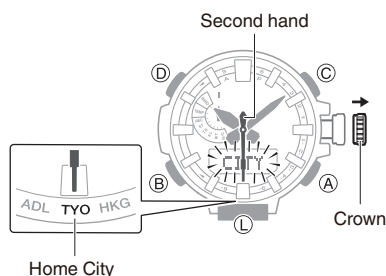

- Press (B) twice.

This causes [KEY♪] or [MUTE] to flash on the display.

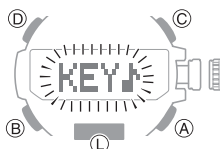

- Rotate the crown to select either [KEY♪] or [MUTE].

[KEY♪]: Operation tone enabled.

[MUTE]: Operation tone muted.

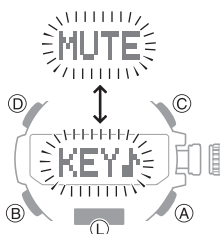

- Push the crown back in to complete the setting operation.

Note

- If you do not perform any operation for about two minutes after pulling out the crown, crown operations will automatically become disabled. If that happens, push the crown back in and then pull it out again.
- Note that alarm and timer tones will still sound even while the operation tone is muted.

Configuring Power Saving Function Settings

- Enter the Timekeeping Mode.
[🔗 Navigating Between Modes](#)
- Pull out the crown.
 This causes [CITY] to flash on the display and the second hand to move to the current Home City.

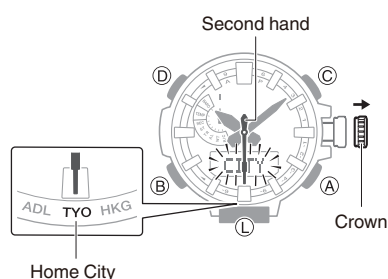

- Press (B) six times.
 This displays [P.SAVE].

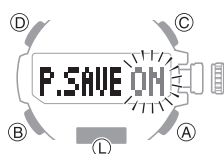

- Rotate the crown to turn the setting on or off.
 [ON]: Power Saving enabled.
 [OFF]: Power Saving disabled.
- Push the crown back in to complete the setting operation.

Note

- If you do not perform any operation for about two minutes after pulling out the crown, crown operations will automatically become disabled. If that happens, push the crown back in and then pull it out again.
- For details about Power Saving, refer to the information below.
[🔗 Power Saving Function](#)

Other Information

This section provides non-operational information you also need to know. Refer to this information as required.

City Table

City code	City Name	Time Zone
UTC	Coordinated Universal Time	0
LON*	London	
PAR*	Paris	+1
ATH*	Athens	+2
JED	Jeddah	+3
THR	Tehran	+3.5
DXB	Dubai	+4
KBL	Kabul	+4.5
KHI	Karachi	+5
DEL	Delhi	+5.5
KTM	Kathmandu	+5.75
DAC	Dhaka	+6
RGN	Yangon	+6.5
BKK	Bangkok	+7
HKG*	Hong Kong	+8
TYO*	Tokyo	+9
ADL	Adelaide	+9.5
SYD	Sydney	+10
NOU	Noumea	+11
WLG	Wellington	+12
PPG	Pago Pago	-11
HNL*	Honolulu	-10
ANC*	Anchorage	-9
LAX*	Los Angeles	-8
DEN*	Denver	-7
CHI*	Chicago	-6
NYC*	New York	-5
YHZ	Halifax	-4
RIO	Rio de Janeiro	-3
RAI	Praia	-1

- * Cities where time calibration signal reception is possible.
- The information in the above table is current as of January 2021.
 - Time zones may change and UTC differentials may become different from those shown in the table above.

Specifications

Accuracy :

±15 seconds per month average when time adjustment using signal reception is not possible.

Basic Functions :

Analog

Hour, minute (moves every 10 seconds), second

Digital

Hour, minute, second, month, day, day of the week

Barometric pressure graph

a.m. (A)/p.m. (P)/24-hour timekeeping

Full Auto Calendar (2000 to 2099)

Signal Receive Functions :

Auto receive, manual receive

Last receive date and time display

Auto summer time switching

Auto transmitter selection (for JJY, MSF/DCF77)

Receivable call signs:

JJY (40 kHz/60 kHz), WWVB (60 kHz), MSF (60 kHz), DCF77 (77.5 kHz), BPC (68.5 kHz)

Auto Receive enable/disable

Digital Compass :

Measurement range: 0° to 359°

Measurement Units: LCD: 1°, Analog: 6°

Continuous Bearing Measurement (1 minute)

North Indication Hand

Compass calibration (2-point calibration, magnetic declination angle)

Altimeter (relative altitude) :

Measuring range: -700 to 10,000 m (or -2,300 to 32,800 ft.)

Display range: -3,000 to 10,000 m (or -9,840 to 32,800 ft.)

(Altitude calibration can be used to display any 10,700 m within the range above.)

Measuring unit: 1 m (or 5 ft.)

Auto measurement interval (2 minutes, 5 seconds)

Altitude calibration

Altitude graph

Altitude differential measurement (-100 to +100 m/-1,000 to +1,000 m (or -325 to +325 ft./-3,280 to +3,280 ft.))

Altitude Memory

Manually Recorded Data

One-press recording of altitude, date (year, month, day), and time. Up to 30 records.

Auto Record Data

One record of high altitude, low altitude, cumulative ascent, cumulative descent

Barometer :

Measurement range: 260 to 1,100 hPa (or 7.65 to 32.45 inHg)
 Display range: 260 to 1,100 hPa (or 7.65 to 32.45 inHg)
 Measurement unit: 1 hPa (or 0.05 inHg)
 Barometric pressure adjustment
 Barometric pressure graph
 Barometric pressure differential indicator
 Barometric pressure change indications

Temperature :

Measuring range: -10.0 to 60.0 °C (or 14.0 to 140.0 °F)
 Display range: -10.0 to 60.0 °C (or 14.0 to 140.0 °F)
 Measuring unit: 0.1 °C (or 0.2 °F)
 Temperature Correction

Sensor Accuracy :

Direction sensor
 Measurement accuracy: Within $\pm 10^\circ$
 (Guaranteed accuracy temperature range: 10 °C to 40 °C (50 °F to 104 °F))
 Bearing hand indication: Within ± 2 gradations

Pressure sensor
 Measurement accuracy: Within ± 3 hPa (0.1 inHg)
 (Altimeter measurement accuracy: Within ± 75 m (246 ft.))

- Guaranteed accuracy temperature range: -10 °C to 40 °C (14 °F to 104 °F)
- Strong impact or prolonged exposure to temperature extremes may negatively affect accuracy.

Temperature Sensor
 Measurement accuracy: Within ± 2 °C (3.6 °F)
 (Guaranteed accuracy temperature range: -10 °C to 60 °C (14 °F to 140 °F))

Stopwatch :

Measuring unit: 1/100 second
 Measuring range:
 23 hours, 59 minutes, 59.99 seconds (24 hours)
 Measurement Functions:
 Elapsed time, cumulative time, split times, 1st and 2nd place finisher times

Timer :

Setting unit: 1 minute
 Measuring range: 60 minutes
 Countdown unit: 1 second
 Time up alert duration: 10 seconds

Alarm :

Time alarms
 Number of alarms: 5
 Setting units: Hours, minutes
 Alarm tone duration: 10 seconds
 Hourly time signal: Beep every hour on the hour

World Time :

Current time in 29 cities (29 time zones), and UTC (Coordinated Universal Time) time
 Summer time
 City swapping
 One-touch UTC display

Other :

Double LED light: LED light for dial and LED backlight for LCD (with Full Auto Light, Super Illuminator, afterglow, afterglow duration setting (1.5 seconds, 3 seconds)); alarm testing; automatic hand position correction; power saving; charge level (battery) indicator; operation tone enable/disable; hand shift

Power Supply :

Solar panel and one rechargeable battery
 Battery operating time: Approximately 6 months
 Conditions:
 Illumination: 1.5 seconds/day
 Beeper: 10 seconds/day
 Digital Compass Operations: 20 times/month
 Mountain climbing: Once/month (Altitude readings: Approximately 1 hour; Barometric pressure change indication measurements: Approximately 24 hours)
 Barometric Pressure Graph: Measurement every 2 hours
 Time signal reception: 4 minutes/day
 Display: 18 hours/day

Specifications are subject to change without notice.

Troubleshooting

Signal Reception (Time Calibration Signal)

Q1 The watch cannot perform a receive operation.

Is the watch's battery charged?

Signal reception is not possible while battery power is low. Keep the watch exposed to light until it recharges sufficiently.

↙ [Charging](#)

Is the watch in the Timekeeping Mode?

Time signal receive is performed only while the watch is in the Timekeeping Mode. Return to the Timekeeping Mode.

↙ [Navigating Between Modes](#)

Is your Home City setting correct for your location?

The watch will not indicate the correct time if the Home City setting is wrong. Change your Home City setting so it correctly reflects your location.

↙ [Setting a Home City](#)

After checking the above, the watch still cannot perform a receive operation.

Time calibration signal reception is not possible under the conditions described below.

- When watch is at Level 2 power saving
- When the crown is pulled out
- Timer countdown operation in progress

If successful reception is not possible for some reason, you can adjust the time and day settings manually.

Q2 The signal receive operation always fails.

Is the watch in a location that is appropriate for signal reception?

Check your surroundings and move the watch to a location where signal reception is better.

↙ [Appropriate Signal Reception Location](#)

Did you avoid touching the watch while the receive operation was in progress?

Minimize movement of the watch and do not perform any watch operation while a receive operation is in progress.

Is there an alarm configured to sound during the same period that the signal receive operation is performed?

Receive stops if an alarm operation starts while it is being performed. Disable the alarm.

↙ [Turning Off an Alarm or the Hourly Time Signal](#)

Is the signal transmitter in your area transmitting a signal?

The transmitter of the time calibration may not be transmitting a signal. Try again later.

Q3 Signal reception should have been successful, but the watch's time and/or day is wrong.

Is the indicated time off by one hour or by 30 minutes?

The watch may be using the wrong time offset. Specify the area you want to use as your Home City.

↙ [Setting a Home City](#)

Is the indicated hour and/or minute wrong?

The hour hand and/or minute hand may be out of alignment. Perform the procedure under "Hand Alignment Adjustment" to auto adjust hour and minute hand alignment.

↙ [Hand Alignment Adjustment](#)

After checking the above, the time and/or day settings is still wrong.

Adjust time and day settings manually.

↙ [Using Watch Operations to Adjust the Time Setting](#)

Altitude Measurement

Q1 Readings produce different results at the same location.

Watch readings are different from altitude information available from other sources.

Correct altitude readings are not possible.

Relative altitude is calculated based on changes in barometric pressure measured by the watch's pressure sensor. This means that barometric pressure changes can cause readings taken at the same location to be different. Also note that the value displayed by the watch may be different from the actual elevation and/or sea level elevation indicated for the area where you are located. When using the watch's altimeter while mountain climbing, it is recommended that you regularly calibrate its readings in accordance with local altitude (elevation) indications.

↙ [Calibrating Altitude Readings \(Offset\)](#)

Q2 Following a relative altitude reading, the watch's second hand points to 9 o'clock.

The second hand will move to 9 o'clock if a reading is outside the allowable altitude measurement range (-700 m to 10,000 m (-2,300 to 32,800 feet)). If [ERR] is displayed, there may be a problem with the sensor.

↙ [Checking the Altitude Differential from a Reference Point](#)

Q3 [ERR] appears during measurement.

There may be a problem with the sensor. Try taking another measurement.

If [ERR] keeps appearing after multiple measurement attempts, contact a CASIO service center or your original retailer.

Digital Compass

Q1 The entire display is flashing.

Abnormal magnetism has been detected. Move away from any potential source of strong magnetism and try taking a reading again.

↙ [Digital Compass Reading Precautions](#)

- If the display flashes again, it could mean that the watch itself has become magnetized. Move away from any potential source of strong magnetism, perform 2-point calibration, and then try taking a reading again.

↙ [Calibrating Compass Readings](#)

Q2 [ERR] appears during measurement.

There is a problem with the sensor or there may be a source strong magnetic force nearby. Move away from any potential source of strong magnetism and try taking a reading again. If [ERR] keeps appearing after multiple measurement attempts, contact a CASIO service center or your original retailer.

↙ [Digital Compass Reading Precautions](#)

Q3 [ERR] appears following 2-point calibration.

[ERR] on the display could indicate a sensor problem.

- If [ERR] disappears after about one second, try performing 2-point calibration again.
- If [ERR] keeps appearing after multiple attempts, contact a CASIO service center or your original retailer.

Q4 Direction information indicated by the watch is different from that indicated by a backup compass.

Move away from any potential source of strong magnetism, perform 2-point calibration, and then try taking a reading again.

↙ [Calibrating Compass Readings](#)

↙ [Digital Compass Reading Precautions](#)

Q5 Readings at the same location produce different results. Cannot take readings indoors.

Move away from any potential source of strong magnetism and try taking a reading again.

↙ [Digital Compass Reading Precautions](#)

Barometric Pressure Measurement

Q1 Following a relative barometric pressure reading, the watch's second hand points to 9 o'clock.

The second hand will move to 9 o'clock if a reading is outside the allowable barometric pressure measurement range (260 hPa to 1,100 hPa (7.65 inHg to 32.45 inHg)). If [ERR] appears on the display, there may be a problem with the sensor.

[Checking the Change in Barometric Pressure between Two Readings](#)

Q2 [ERR] appears during measurement.

There may be a problem with the sensor. Try taking another measurement. If [ERR] keeps appearing after multiple measurement attempts, contact a CASIO service center or your original retailer.

Temperature Measurement

Q1 [ERR] appears during measurement.

There may be a problem with the sensor. Try taking another measurement. If [ERR] keeps appearing after multiple measurement attempts, contact a CASIO service center or your original retailer.

World Time

Q1 The time for a World Time City is not correct.

The summer time setting (standard time/summer time) may be wrong.

[Specifying a World Time City](#)

Alarm and Hourly Time Signal

Q1 An alarm does not sound.

Is the watch's battery charged?

Keep the watch exposed to light until it recharges sufficiently.

[Charging](#)

The crown is pulled out.

The alarm will not sound while the crown is pulled out. Push the crown back in to its normal position.

Other than the above.

The alarm's settings may not be configured. Configure the alarm settings.

[Configuring Alarm Settings](#)

Q2 The hourly time signal does not sound.

Is the watch's battery charged?

Keep the watch exposed to light until it recharges sufficiently.

[Charging](#)

The crown is pulled out.

The hourly time signal will not sound while the crown is pulled out. Push the crown back in to its normal position.

Other than the above.

The hourly time signal may be disabled. Enable the hourly time signal.

[Enabling the Hourly Time Signal](#)

Hand Movement and Watch Screen Indications

Q1 I don't know what mode the watch is in.

You can determine the current mode by checking the watch display. Use (B) to navigate between modes.

[Navigating Between Modes](#)

Q2 The second hand is jumping at two-second intervals.

Battery power is low. Keep the watch exposed to light until it recharges sufficiently.

[Charging](#)

Q3 All hands are stopped and buttons do not work.

The battery is dead. Keep the watch exposed to light until it recharges sufficiently.

[Charging](#)

Q4 The hands suddenly start moving at high speed.

This is due to the reason (or one of the reasons) below, and does not indicate malfunction. Simply wait until normal hand movement resumes.

- The watch is recovering from a power saving state.
[Power Saving Function](#)
- A time calibration signal is being received and the time setting is being adjusted.
[Time Adjustment Using a Time Signal](#)

Q5 Hands are stopped and buttons do not work.

The watch is in the charge recovery mode. Wait until the recovery process is complete (for about 15 minutes). The watch will recover more quickly if you place it in a brightly lit location.

Q6 Why is the current time indicated by the watch is off by a certain amount of time (nine hours, three hours and 15 minutes, etc.)?

The city setting is not correct. Select the correct setting.

[🔗 Setting a Home City](#)

Q7 The current time indicated by the watch is off by one hour or 30 minutes.

The summer time setting may not be correct. Select the correct setting.

[🔗 Setting a Home City](#)

Q8 The time indicated by the hands is different from the displayed time.

Strong magnetism or impact can cause the hands to go out of alignment. Adjust hand alignment.

[🔗 Hand Alignment Adjustment](#)

Crown Operations

Q1 Nothing happens when I rotate the crown.

If you do not perform any operation for about two minutes after pulling out the crown (approximately 30 minutes in the case of hand and day indicator alignment), crown operations will automatically become disabled. Push the crown back in to its normal position and then pull it out again to re-enable crown operations.

[🔗 Using the Crown](#)

Charging

Q1 The watch does not work even though it is exposed to light.

The watch stops operating whenever the battery goes dead. Keep the watch exposed to light until it recharges sufficiently.

[🔗 Checking the Charge Level](#)

Q2 [RECOVER] is flashing on the display.

The watch is in the charge recovery mode. Wait until the recovery process is complete (about 15 minutes). The watch will recover more quickly if you place it in a brightly lit location.

- If a sensor measurement operation, illumination and/or other power-intensive functions are used within a short period of time, the charging capacity of the battery drops and causes the watch to go into a charge recovery mode. Function availability is temporarily limited, but functionality returns after the battery recovers.

[🔗 Checking the Charge Level](#)



Q3 [CHARGE] is flashing on the digital display.

The charge level of the watch is extremely low. Immediately expose the watch to light to charge it.

[🔗 Checking the Charge Level](#)

Other

Q1 I can't find the information I need here.

Visit the website below.

<https://world.casio.com/support/>