

CITIZEN®

ManualsLib.com



-

ManualsLib.com

-

-

-

-

-

-

•

•

•

•

ManualsLib.com

•

•

•

•

ManualsLib.com



TIME

ALM

TEMP

LOG

PLOG

SURF

T R

BUSY



Alternative indication

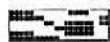
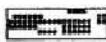

Alternative indication

SLOW

CHEK

BAT

ERR

ManualsLib.com

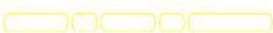

Ⓜ : Push the Ⓜ button for 2 sec.
 ←--- : Indicated only in surface mode
 ←--- : Auto-return

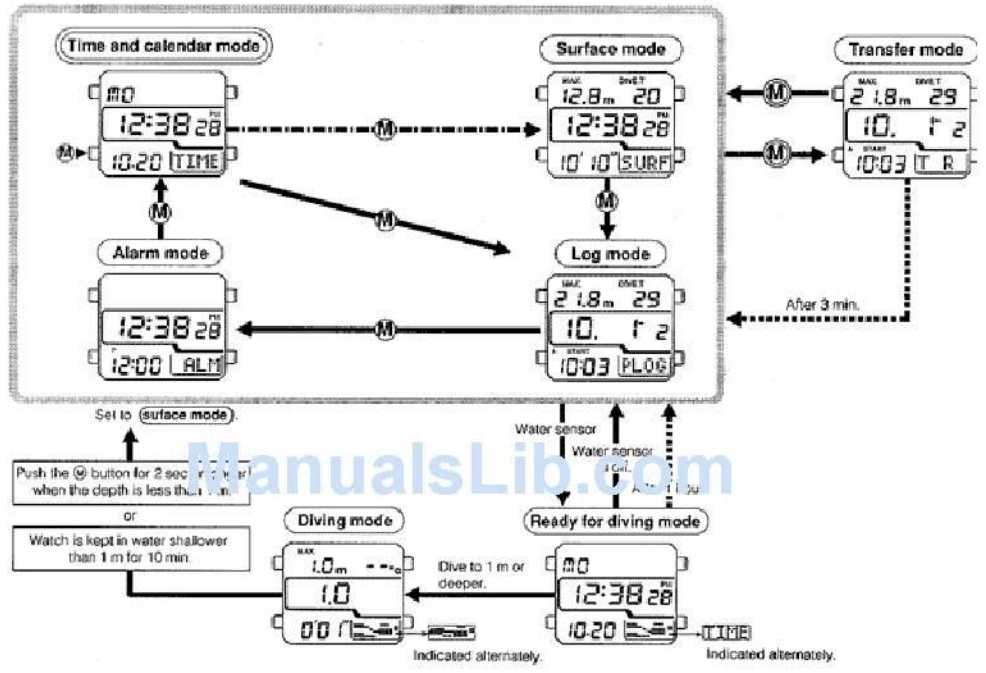

ManualsLib.com

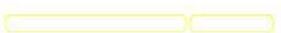

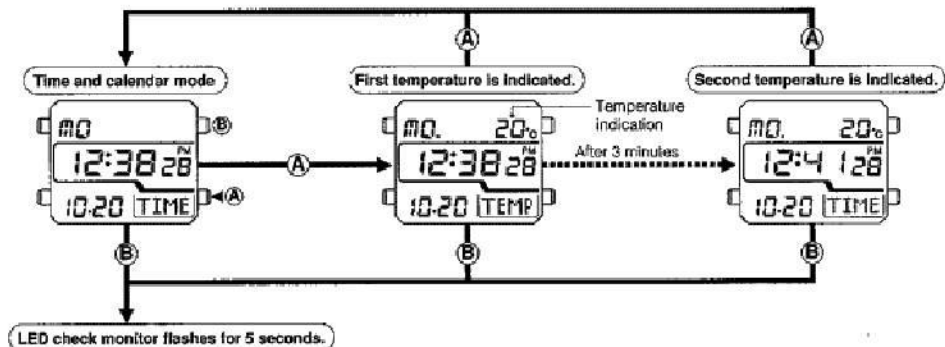

ManualsLib.com

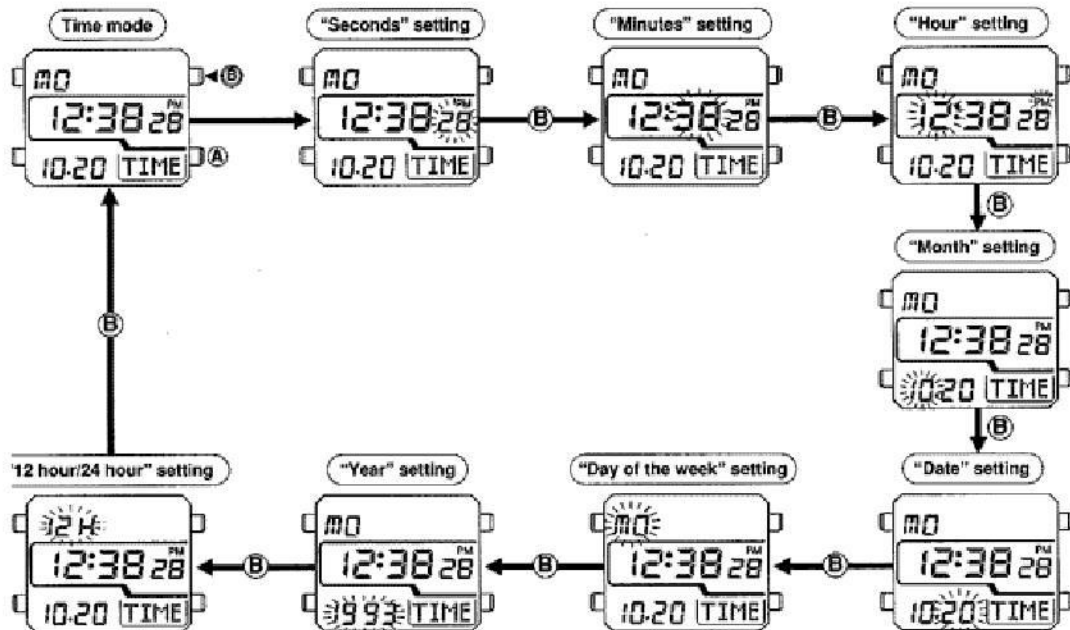



-
-

- (B) : Push the (B) button for 2 sec.
- ←..... : Auto-return
- ⊙ : Flashing

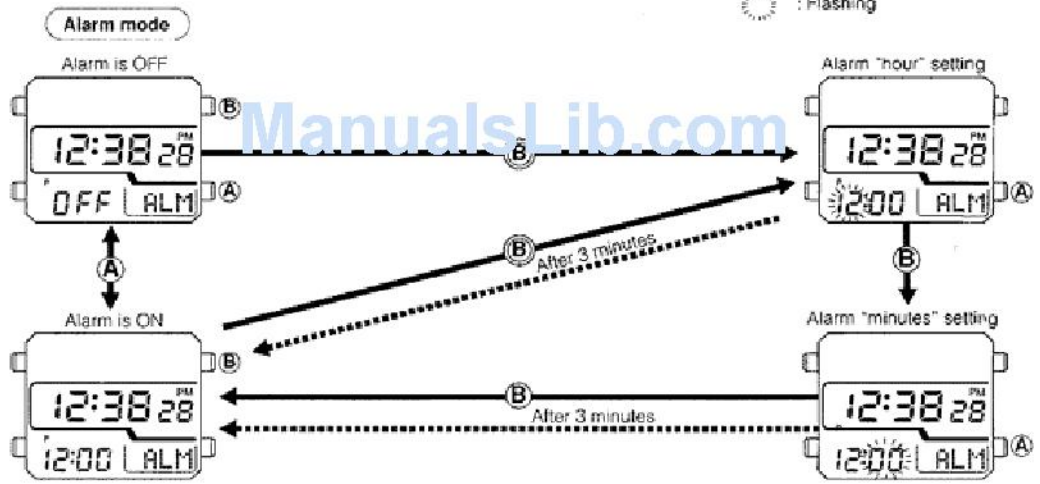

ManualsLib.com

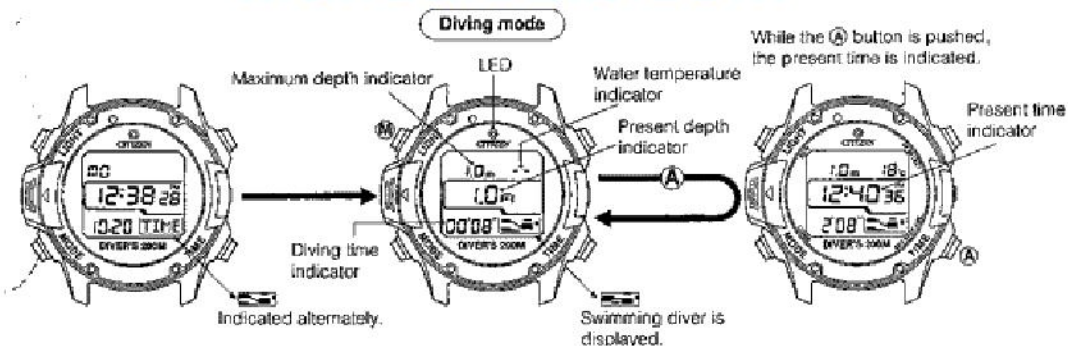

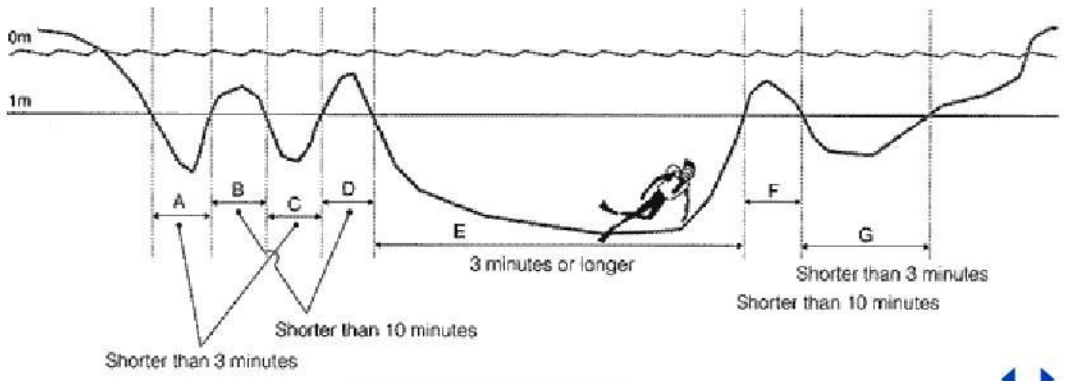
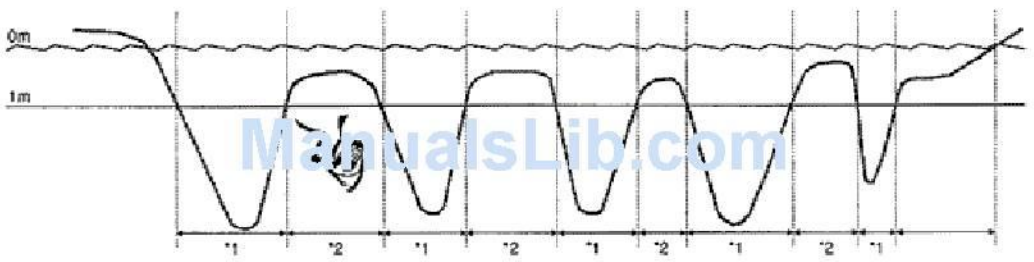
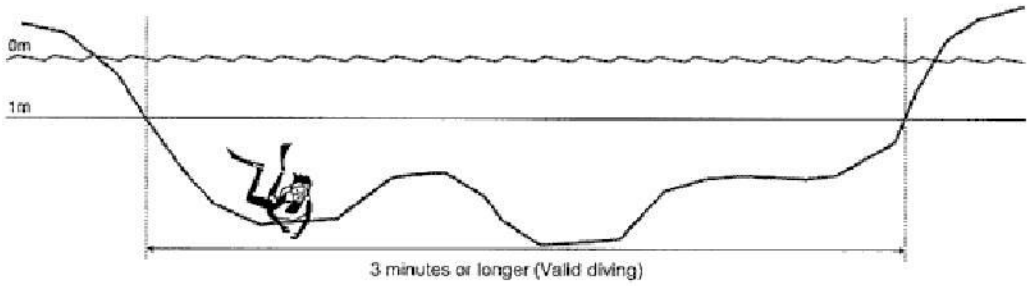

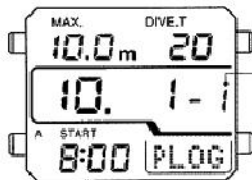

Diving No.



Diving No.





ManualsLib.com

-
-
-
-

Finish of valid diving

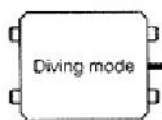
Measurement in surface mode



Surface mode
 Measurement and indication are started.
 (Push the  button for 2 seconds to change the indication.)



After 24 hour
 Measurement and indication in surface mode are finished.

If in surface mode, watch is returned to time and calendar mode.



ManualsLib.com

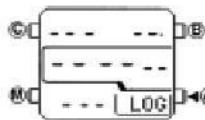

First log indication

Second log indication

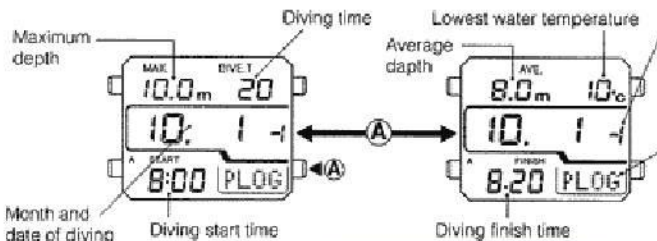

Diving No.
 • The diving No. can be indicated up to 9.
 • If the diver dives 10 times or more in one day, the diving No. start from 1 again. Then, judge the No. of each diving in the date by the diving start time.

If the log data contains the profile data, "PLOG" is indicated.

If the log data does not contain the profile data, "LOG" is indicated.

• Only the data marked with "PLOG" can be transferred to a personal computer.



-
-
-
-
-
-
-

ManualsLib.com

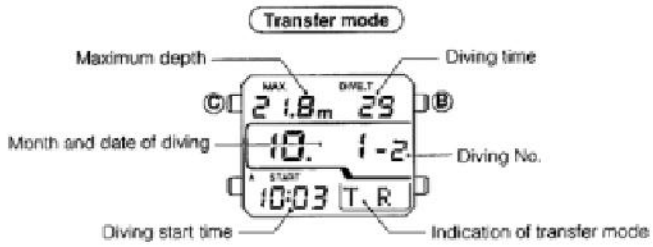

Connection pin

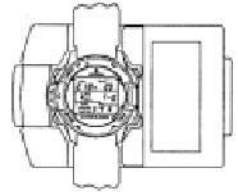
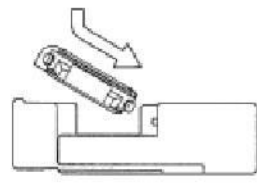
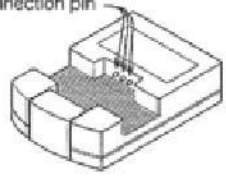

ManualsLib.com



-
-

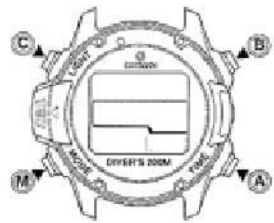



•

•

•



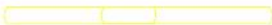

•

•

ManualsLib.com



ManualsLib.com

ManualsLib.com
