

# ***TECHNICAL INFORMATION***

---

**CITIZEN QUARTZ**  
**Cal. No. 0580**



 **CITIZEN**  
CITIZEN IS A REGISTERED TRADEMARK OF CITIZEN WATCH CO., JAPAN.

**Contents**

<b>§1. FEATURES</b> .....	1
<b>§2. SPECIFICATIONS</b> .....	1
<b>§3. DISPLAYS AND BUTTONS</b> .....	1
<b>§4. SETTING THE TIME</b> .....	2
<b>§5. SETTING THE DATE</b> .....	2
<b>§6. USING THE ALARM</b> .....	3
<b>§7. USING THE CHRONOGRAPH</b> .....	4
<b>§8. RESETTING THE CHRONOGRAPH HANDS</b> <b>(After Replacing the Battery)</b> .....	5
<b>§9. FITTING METHOD OF HANDS</b> .....	6
<b>§10. DISASSEMBLY AND ASSEMBLY OF THE MODULE</b> .....	7
<b>§11. TROUBLESHOOTING AND ADJUSTMENT</b> .....	11

## §1. FEATURES

This analog quartz watch has an alarm function of reference hand type, in addition to a chronograph function easy to use.

## §2. SPECIFICATIONS

<b>Caliber NO.</b>		<b>0580</b>
Type		Analog quartz watch
Module size (mm)		ø29.7 × 5.10t
Accuracy		±20 seconds per month on average (when worn at normal temperatures of 5°C to 35°C)
IC		C/MOS-LSI, 1unit
Operating temperature range		-10°C to +60°C
Time adjustment		Impossible
Measurement gate		10 sec.
Additional functions	Chronograph	12-hour measurement and 1/20 second unit
	Alarm	Hand type
	Indication of ON/OFF	<ul style="list-style-type: none"> <li>• 2 minutes (oozing)</li> <li>• Six times for 15 seconds (oozing for 165 seconds) x 5 times</li> <li>• Indication of ON/OFF</li> </ul>
Battery	Battery No.	280-44 (SR927W)
	Battery life	Approximately 3 years

## §3. DISPLAYS AND BUTTONS

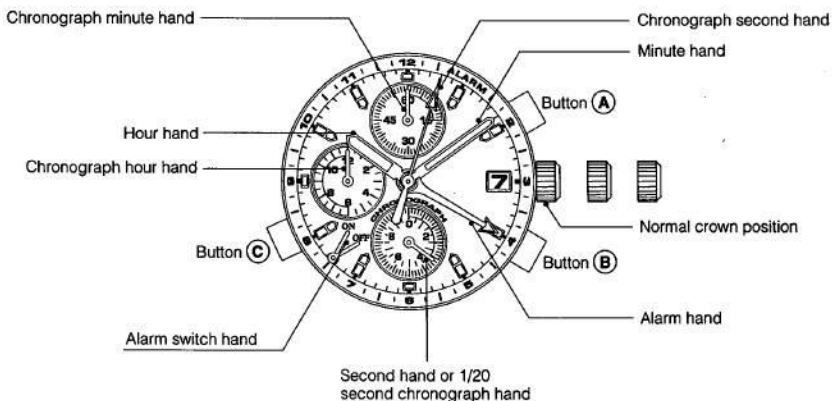

## §4. SETTING THE TIME

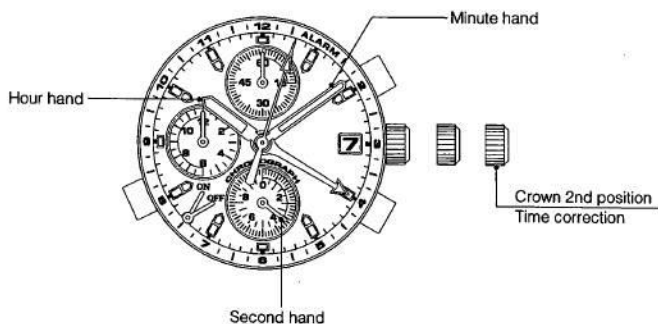

1. Pull the crown out to the 2nd position so that the second hand stops at the (0) position.
2. Turn the crown to set the hour and minute hands.
3. When the crown is pushed back in to the normal position in synchronization with a time signal, the small second hand begins to run.

## §5. SETTING THE DATE

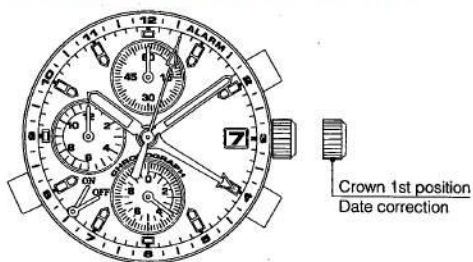

1. Pull the crown to the 1st position.
2. Turn the crown to the left to set the date.
  - \* If the date is set between the hours of around 9:00 PM and 1:00 AM, the date may not change on the following day.
3. After the date has been set, push the crown back in to the normal position.

## §6. USING THE ALARM

Pull button ③. Alarm sounds when the hour hand aligns with the alarm hand.

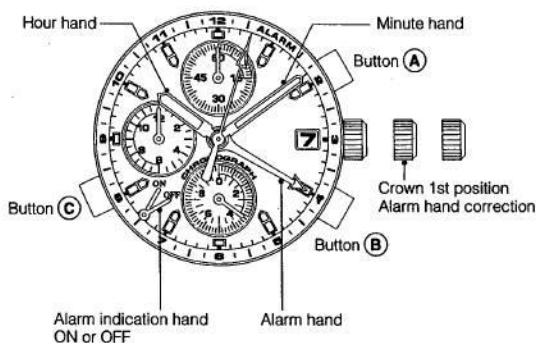

### [Setting the Alarm Time]

1. Pull the crown out to the 1st position.
2. Turn the crown to the right to set the alarm hand to the desired set time.  
The date can be changed by turning the crown to the left.
3. Return the crown to the normal position.
4. Pull out button ③ to turn the alarm on.
5. The alarm will sound when the hour hand aligns with the alarm hand.

### [Switching the Alarm On and Off]

- \* Pull out the button ③ to the 1st position: Alarm ON
- \* Return the button ③ to the normal position: Alarm OFF

### [Turning Off the Alarm]

- \* Return the button ③ to the normal position while alarm is sounding, and the alarm sound will stop.

### [Length of Sounding Time of Alarm]

- \* "The alarm sounds for 15 seconds, then stops sounding for 2 minutes and 45 seconds." This cycle is repeated five times.

## §7. USING THE CHRONOGRAPH

- \* This chronograph is able to measure and display time in 1/20 second units up to a maximum of 12 hours.
- \* The chronograph 1/20 second hand keeps time continuously for 30 seconds after starting, and then stops at the 0 position.

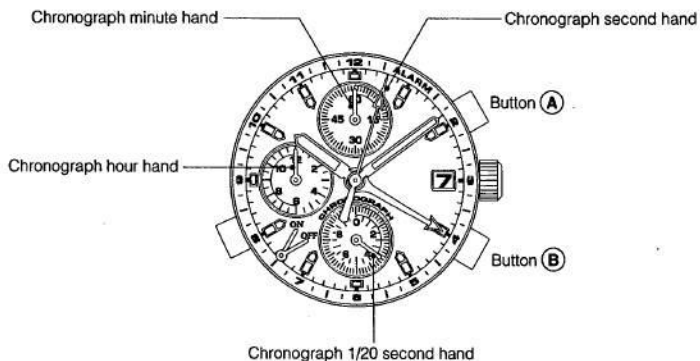

### [Measuring Time with the Chronograph]

1. Press button (B) to enter the watch into the chronograph mode.
  - \* The second hand stops at the 0 second position, and changes to the chronograph 1/20 second hand.
2. The chronograph can be started and stopped each time button (A) is pressed.
  - \* The chronograph 1/20 second hand stops at the 0 second position 30 seconds after starting. When button (A) is pressed to stop the chronograph, the chronograph 1/20 second hand advances rapidly to display the measured time.
3. Pressing button (B) to reset the chronograph and all hands return to their 0 positions.

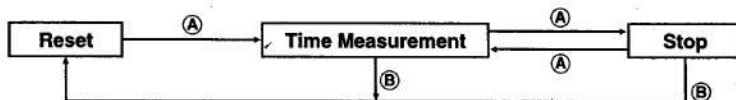

## §8. RESETTING THE CHRONOGRAPH HANDS (AFTER REPLACING THE BATTERY)

This procedure should be performed when the chronograph second hand and chronograph 1/20 second hand do not return to the 0 second position after the chronograph has been reset, and including after the battery has been replaced.

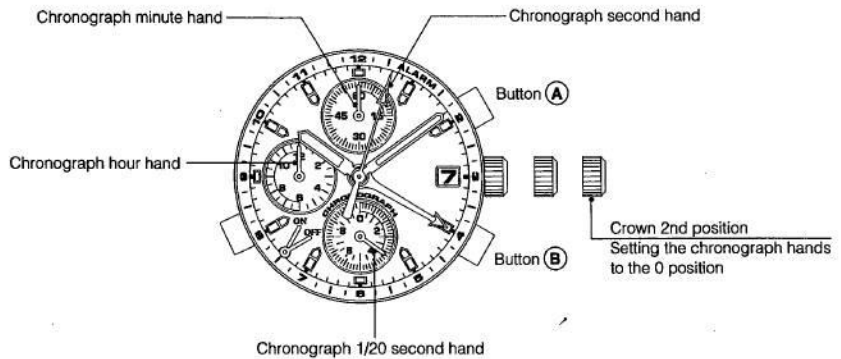

1. Pull the crown out to the 2nd position.
2. Press button (A) to set the chronograph second hand to the 0 position.
3. Press button (B) to set the chronograph 1/20 second hand to the 0 position.  
\* The chronograph hands can be advanced rapidly by continuously pressing button (A) or (B).
4. Once the hands have been zeroed, reset the time and return the crown to its normal position.
5. Press button (B) to check that the chronograph hands are reset to the 0 position.

## §9. FITTING METHOD OF HANDS

Place the module on the case back shown in the figure and position the reference hand, then fit the hands according to the following procedure.

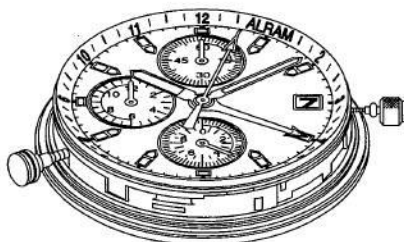

1. Pull out the © button to turn on the alarm.
2. Pull out the crown to the time setting position.
3. Turn the crown to the left, and stop it just after the date changes. After the date starts changing, turn the crown slowly.
4. Push in the crown by not putting a foot on turning it.
5. Turn the crown slowly to the right until the alarm starts sounding, then stop it.
6. Pull out the crown to the time setting position again, taking care not to turning it.
7. Turn the crown to the right until the alarm stops sounding.
8. Turn the crown slowly to the left until the alarm starts sounding again.
9. Stop turning the crown just after the alarm starts sounding, then fit the reference hand, hour hand and minute hand to the 12-o'clock position. When fitting the hands, remove the case back and place the module on the work stand.

# §10. DISASSEMBLY AND ASSEMBLY OF MODULE

Disassembly procedure: ① → 69

Assembly procedure: 69 → ①

● Lubrication mark

- Ⓐ : A-Lube oil
- ∇ : V-Lube oil
- Ⓢ : F-Lube oil
- ∞ : CH-1 oil

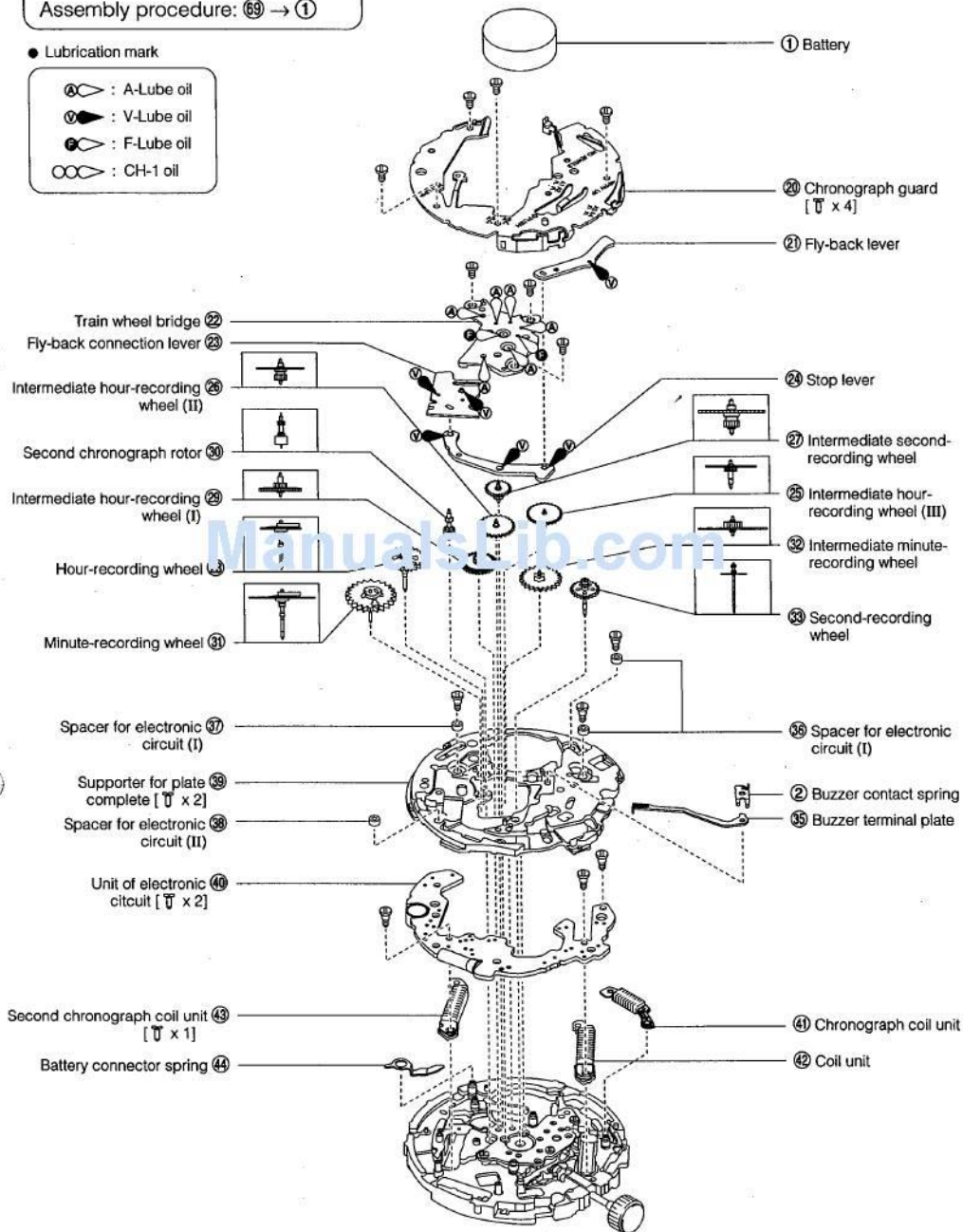

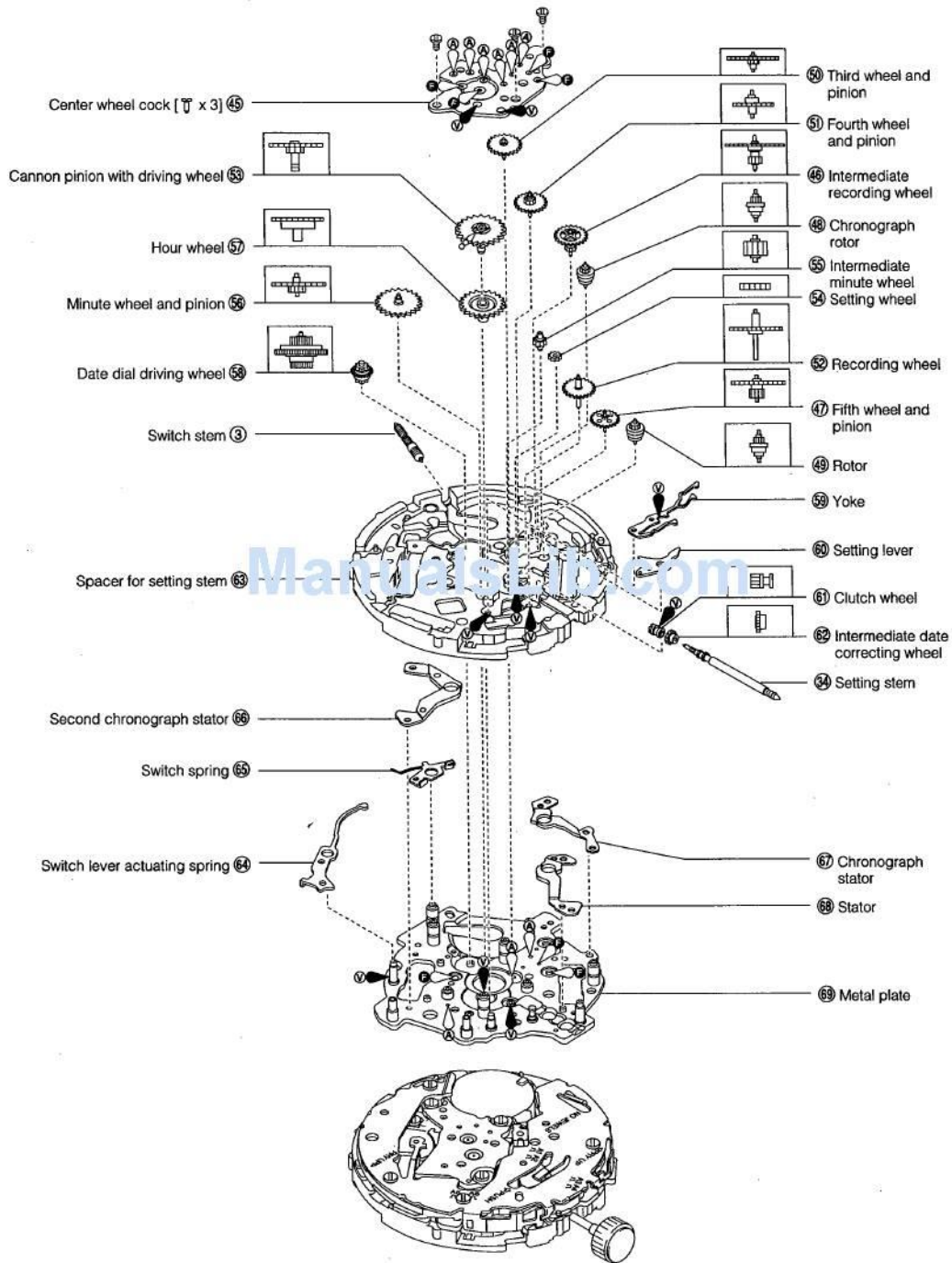

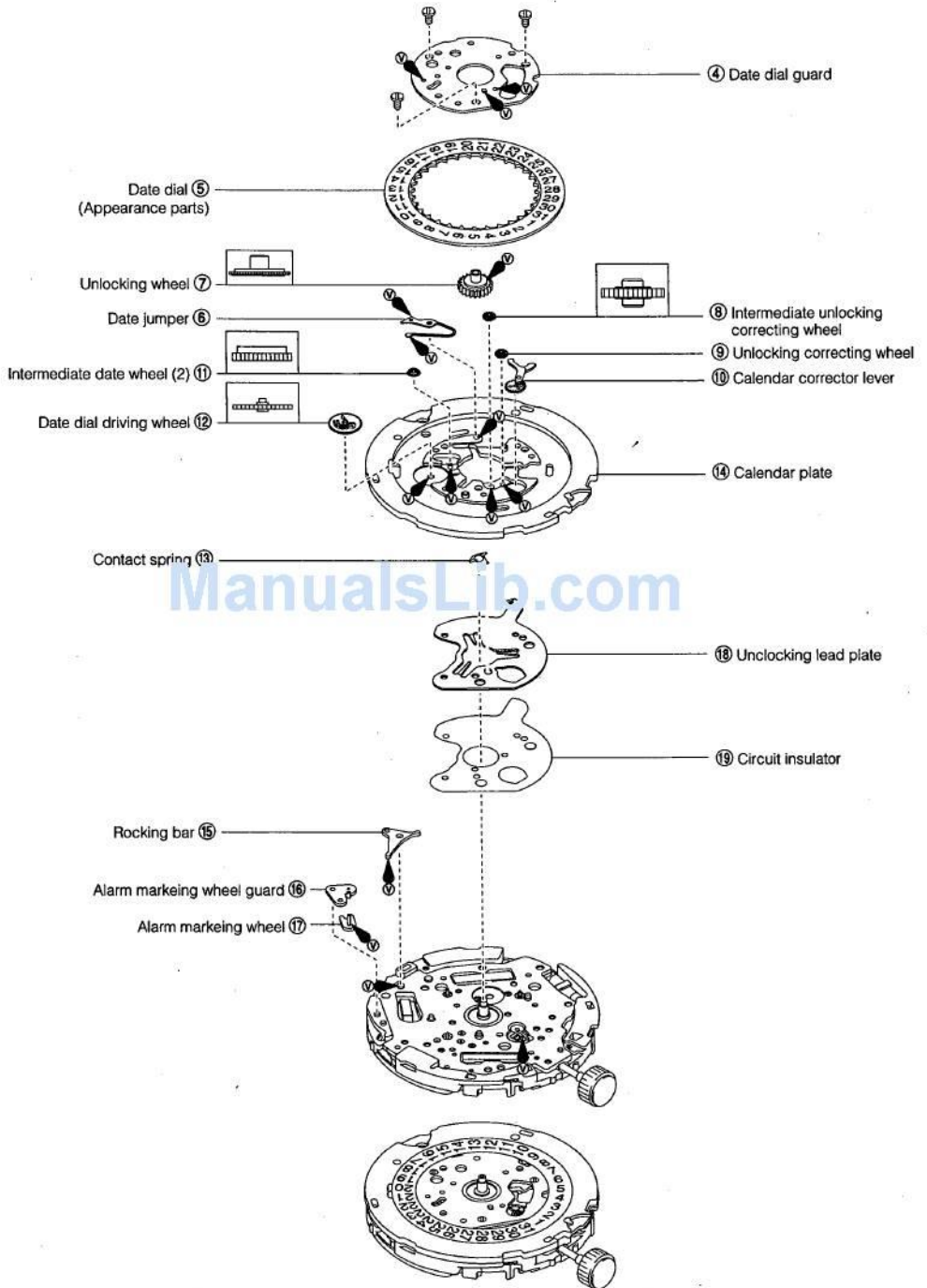

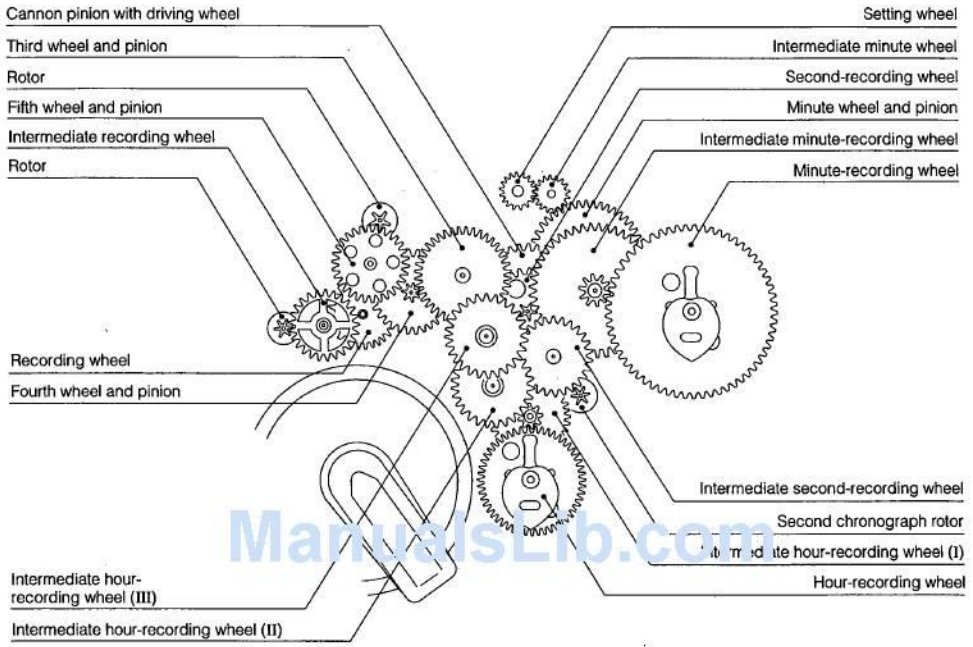

# Arrangement of wheel on dial side

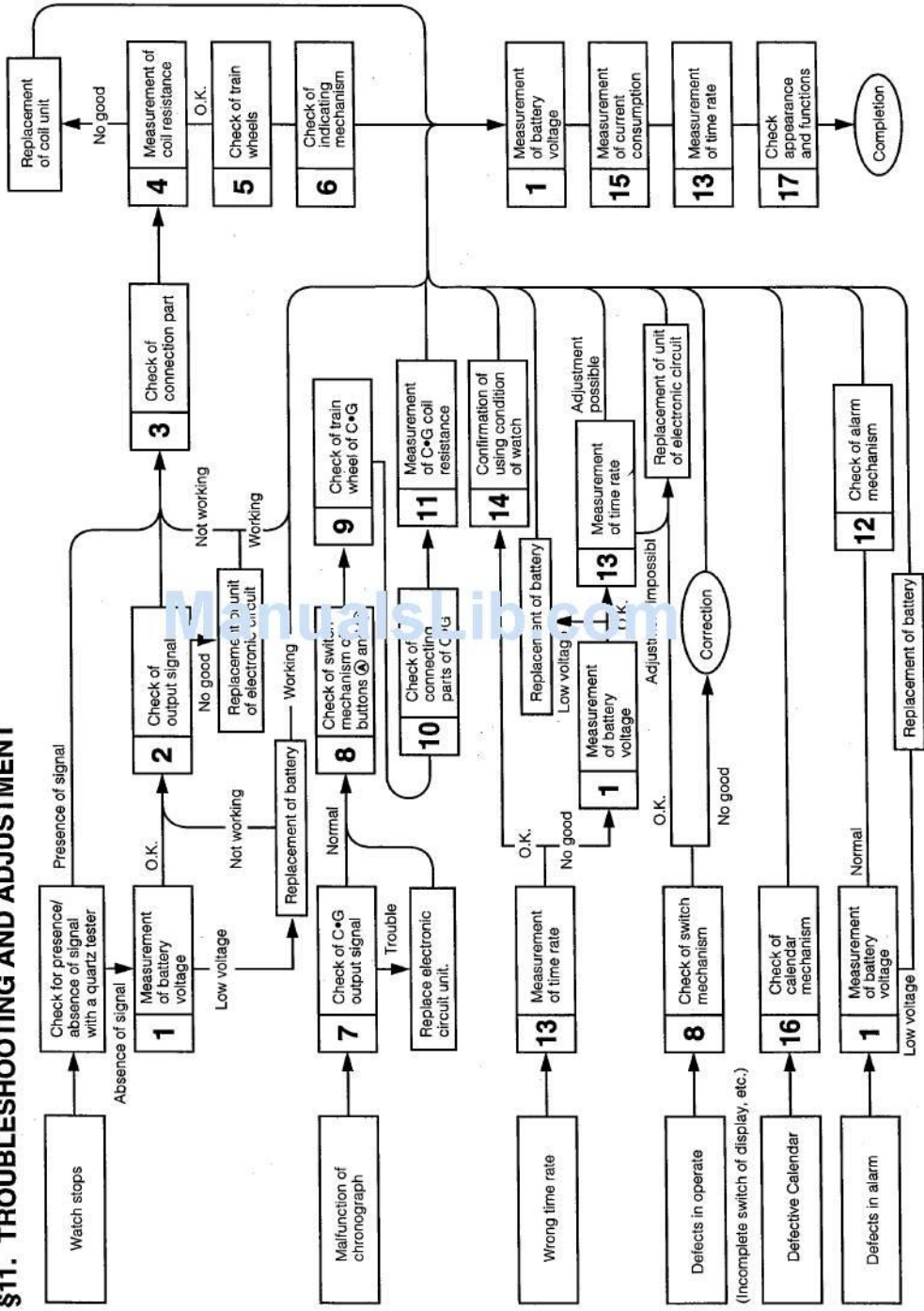

## §11. TROUBLESHOOTING AND ADJUSTMENT

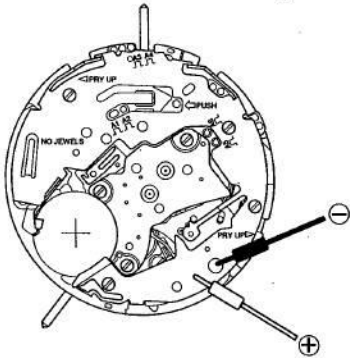
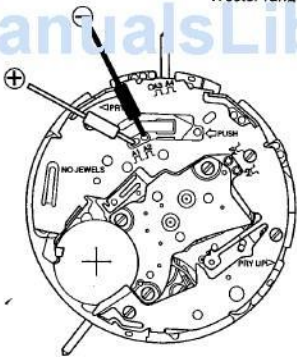

Check Items	Method	Results and and Repair Procedure
<p>① Measurement of battery voltage</p>	<p>* Refer to Technical Manual, Basic Course: II-1-a for the setting procedure of tester</p> <p style="text-align: right;">&lt;Tester range: D.C. 3V&gt;</p> 	<p>Measurement of voltage of battery in complete module</p> <ul style="list-style-type: none"> <li>• <b>Above 1.5V</b> → Normal</li> <li>• <b>Below 1.5V</b> → Measure voltage of battery removed from module.</li> </ul> <p>Measurement of voltage of battery removed from module</p> <ul style="list-style-type: none"> <li>• <b>Above 1.5V</b> → Check connecting parts.</li> <li>• <b>Below 1.5V</b> → Replace battery.</li> </ul>
<p>② Check of output signal</p>	<p>* Refer to Technical Manual, Basic Course: II-1-b for the setting procedure of the tester.</p> <p style="text-align: right;">&lt;Tester range: D.C. 0.3V&gt;</p>  <p>This watch outputs the following signals.</p> <ul style="list-style-type: none"> <li>• Output signals (A1<math>\mu</math>L, A2<math>\mu</math>L) of the time system (Second, minute, and hour)</li> <li>• Output signals (A3<math>\mu</math>L, A4<math>\mu</math>L) of the chronograph system (Second, minute, and hour)</li> <li>• Output signals (A5<math>\mu</math>L, A6<math>\mu</math>L) of the 1/20-sec chronograph system.</li> </ul> <p>If the watch stops, check the output signals A1<math>\mu</math>L and A2<math>\mu</math>L among the above signals.</p> <ul style="list-style-type: none"> <li>* Confirm that the crown is at the normal position (0 stage).</li> <li>* The tester lead pins have no polarity.</li> </ul>	<p><b>Output signals of A1 and A2</b></p> <ul style="list-style-type: none"> <li>• Tester pointer moves to right and left from 0V every 1 sec. → Normal</li> <li>• Tester pointer does not moves. → Replace electronic circuit unit</li> </ul>

Check Items	Method	Results and and Repair Procedure
<p>③ Check of connection part</p>	<p>* Refer to the analog part of Technical Manual, Basic Course: II-2-a.</p> <p>Check for looseness of screws, dust and dirt.</p> <p>a) If the lock screw of the electric circuit is loosened, the drive signals may not be transferred.</p> <p>b) Dust and dirt sticking to the coil and pattern of the electric circuit can cause a continuity trouble.</p>	
<p>④ Measurement of coil resistance</p>	<p>* Refer to Technical Manual, Basic Course: II-1-c for the setting procedure of the tester.</p> <p><b>(If the watch has stopped.)</b></p> <p>Remove the electronic circuit unit, then measure the resistance of the coil.</p> <div style="text-align: center;">  <p>&lt;Tester range: x 10Ω&gt;</p> </div>	<p>1) Measurement of coil unit</p> <ul style="list-style-type: none"> <li>• 1.9 kΩ ~ 2.3 kΩ → Non-defective</li> <li>• Out of 1.9 kΩ ~ 2.3 kΩ → Replace of coil unit</li> </ul>
<p>⑤ Check of train wheel</p>	<p>* Refer to Technical Manual, Basic Course: II-2-b.</p> <p>Check the gears and rotors for dust.</p>	
<p>⑥ Check of indicating mechanism</p>	<ul style="list-style-type: none"> <li>• Check the hour wheel, minute wheel and pinion, and second wheel and pinion.</li> </ul>	

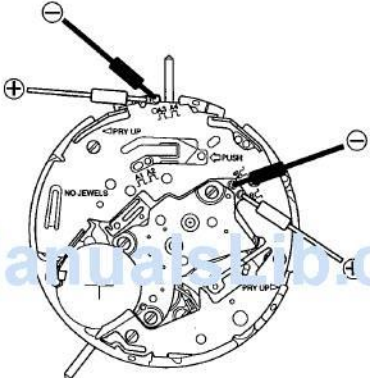
Check Items	Method	Results and and Repair Procedure
<p>7 Check of output signals of C•G</p>	<p>* For the setting method of the tester, see Basic Section II-1-b.</p> <ul style="list-style-type: none"> <li>• Check the output signals (A3 JL, A4 JL) to drive the step motor for the second, minute, and hour hands of the chronograph.</li> <li>• Check the output signals (A5 JL, A6 JL) to drive the step motor for the 1/20 sec chronograph</li> </ul> <p><b>(Measuring method)</b> Before measuring any of the above signals, start the chronograph. Since the output signal of the 1/20 sec chronograph stops 30 seconds after the start, measure it in this 30 seconds.</p> 	<p><b>a. Output signals of chronograph (Second, minute, and hour)</b></p> <ul style="list-style-type: none"> <li>• Tester pointer moves to right and left from 0V every 1 sec. → Normal</li> <li>• Tester pointer does not move. → Replace electronic circuit unit.</li> </ul> <p><b>b. Output signals of 1/20-sec chronograph</b></p> <ul style="list-style-type: none"> <li>• Tester pointer litters at 0V. → Moves little by little/bit by bit.</li> <li>• Tester pointer does not move. → Replace electronic circuit unit.</li> </ul>
<p>8 Check of switch mechanism of button A and B</p>	<ol style="list-style-type: none"> <li>1) Confirm that the buttons A and B operate smoothly and check the switch springs of A and B for deformation.</li> <li>2) Check the part between the switch springs and pattern of the electronic circuit unit of dirt and dust.</li> <li>3) Confirm that the fly-back connection lever, stop lever, and flay-back lever are installed normally.</li> </ol>	<ol style="list-style-type: none"> <li>1) Buttons do not move smoothly. • Dust or dirt → Clean.</li> <li>• Supply oil to push button packings again.</li> <li>• Deformation → Replace parts.</li> </ol> <ol style="list-style-type: none"> <li>2) Dust or dirt → Clean.</li> </ol>
<p>9 Check of train wheel of chronograph</p>	<p>* Refer to Technical Manual, Basic Course: II-2-b.</p>	
<p>10 Check of connecting part of chronograph</p>	<p>* Refer to Technical Manual, Basic Course: II-2-a.</p>	

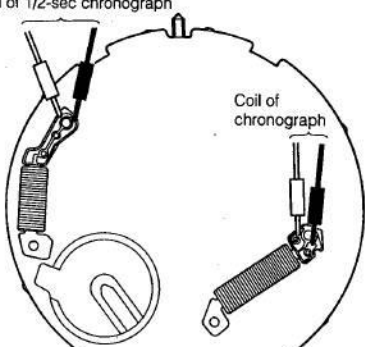
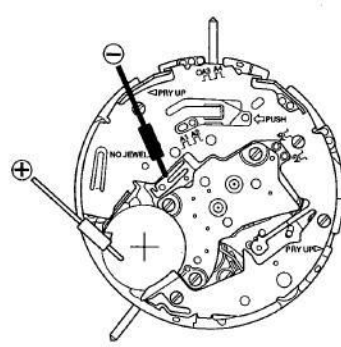
Check Items	Method	Results and and Repair Procedure
<p>11 Measurement of coil resistance of chronograph</p>	<p>* Refer to Technical Manual, Basic Course: II-1-c for the setting procedure of the tester.</p> <p>Coil of 1/2-sec chronograph</p>  <p>Coil of chronograph</p>	<p><b>Coil of chronograph</b></p> <ul style="list-style-type: none"> <li>• 2.0 kΩ ~ 2.5 kΩ → Normal</li> <li>• Out of 2.0 kΩ ~ 2.5 kΩ → Replace coil of chronograph.</li> </ul> <p><b>Coil of 1/20-sec chronograph</b></p> <ul style="list-style-type: none"> <li>• 1.5 kΩ ~ 2.2 kΩ → Normal</li> <li>• Out of 1.5 kΩ ~ 2.2 kΩ → Replace coil of 1/20-sec chronograph.</li> </ul>
<p>12 Inspection of alarm mechanism</p>	<p>* Check the alarm output without taking the movement out of the case.</p> <ol style="list-style-type: none"> <li>1. Pull out the © button to turn on the alarm.</li> <li>2. Push the crown with the test pin.</li> <li>3. Turn the crown to the right to match the reference hand to the hour hand, and set the alarm time.</li> <li>4. Apply and hold the positive ⊕ tester lead pin to the top of the battery and the negative ⊖ pin to the buzzer contact spring until the alarm operates. <ul style="list-style-type: none"> <li>• The alarm repeats the operation of (sounding for 15 seconds + no sounding for 165 seconds) 5 times.</li> </ul> </li> </ol> 	<ul style="list-style-type: none"> <li>• Tester pointer does not move. → Replace electric circuit.</li> <li>• Tester pointer moves. → Normal</li> </ul> <p style="text-align: center;">↓</p> <p>Alarm output is normal.</p> <ul style="list-style-type: none"> <li>• Check buzzer contact spring.</li> <li>• Check joints of pattern of electric circuit.</li> <li>• Check piezo-electric element on case back (for cracking and breakage).</li> </ul>
<p>13 Measurement/adjustment of time rate</p>	<p>* Refer to Technical Manual, Basic Course: II-2-d.</p> <ul style="list-style-type: none"> <li>• Since this watch does not have adjustment terminals, its time rate cannot be adjusted in the market.</li> </ul> <p>&lt;Measurement gate: 10 seconds&gt;</p>	

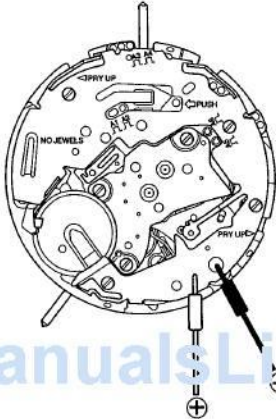
Check Items	Method	Results and and Repair Procedure
<p>14 Confirmation of using condition of watch</p>	<p>* Refer to Technical Manual, Basic Course: II-2-e.</p>	
<p>15 Measurement of current consumption</p>	<p>* Refer to Technical Manual, Basic Course: II-1-f for the setting procedure of the tests.</p> <p><b>1. Measurement of normal time display</b></p>  <p><b>2. Measurement while chronograph is operating</b></p> <p>* Set the tester and measure the current similarly to 1.</p> <p><b>&lt;Measuring method&gt;</b> Push the switch corresponding to the button (A) to start the chronograph hands, the measure the current.</p> <p><b>3. Measurement of electronic circuit unit</b></p> <p>* Set the tester similarly to 1.</p>	<p><b>1. Normal time display</b></p> <ul style="list-style-type: none"> <li>• <b>Under 3.5<math>\mu</math>A</b> → Non-defective</li> <li>• <b>Over 3.5<math>\mu</math>A</b> → Measure the electronic circuit unit separately</li> </ul> <p><b>2. While chronograph is in operation</b></p> <ul style="list-style-type: none"> <li>• <b>Under 160<math>\mu</math>A</b> → Non-defective</li> <li>• <b>Over 160<math>\mu</math>A</b> → Measure electronic circuit unit</li> </ul> <p><b>3. Measurement of electronic circuit unit</b></p> <ul style="list-style-type: none"> <li>• <b>Under 0.3<math>\mu</math>A</b> → Non-defective</li> <li>• <b>Over 0.3<math>\mu</math>A</b> → Replace the electronic circuit unit.</li> </ul>
<p>16 Check of calendar mechanism</p>	<p>* Refer to Technical Manual, Basic Course: II-2-c.</p>	
<p>17 Check of appearance and functions</p>	<p>* Refer to Technical Manual, Basic Course: II-2-f.</p>	